**User's
Manual**

CA450
Process Multimeter

**Store this manual in an easily
accessible place for quick reference.**

Introduction

Thank you for purchasing our CA450 Process Multimeter.

This User's Manual explains the functions of this Process Multimeter, as well as the operating methods and handling precautions.

Before using this product, thoroughly read this manual to understand how to use it properly.

■ List of Manuals

The following manuals, including this one, are provided as manuals for the CA450. Please read all manuals.

IM CA450-EN	User's Manual (this manual)
IM CA450-93Z2	Document for Korea

Contact information of Yokogawa offices worldwide is provided on the following sheet.

PIM 113-01Z2	Inquiries	List of worldwide contacts
--------------	-----------	----------------------------

■ Notes

- The information contained in this manual is subject to change without notice. Furthermore, the actual display items may differ slightly from the ones appearing in this manual.
- Every effort has been made to ensure the information contained herein is accurate. However, should any concerns, errors, or emissions come to your attention, or if you have any comments, please contact us.
- Copying or reproduction of any or all of the content of this manual without YOKOGAWA's permission is strictly prohibited.

■ Registered Trademarks

"HART" is a registered trademark of the HART Communication Foundation.

Disk No. IMCA450-EN
6th Edition: August 2018 (YMI)
All Rights Reserved, Copyright ©
2010 Yokogawa Test & Measurement Corporation
Printed in Japan

■ Revision Information

1st Edition:	October 2010
2nd Edition:	February 2011
3rd Edition:	March 2015
4th Edition:	October 2016
5th Edition:	October 2017
6th Edition:	August 2018

Checking the Contents of the Package

After receiving the product and opening the package, check the items described below. If the wrong items have been delivered, if items are missing, or if there is a problem with the appearance of the items, contact your nearest YOKOGAWA dealer.

• Model and Suffix Codes

Model	Suffix Code
CA450	-E

• NO. (Serial Number)

Refer to this serial number on the nameplate when contacting the vendor about the instrument.

(For the model, nameplate, and serial number, see section 4.2, "Components.")

• Standard Accessories

Make sure that the package contains all the accessories listed below and that they are all free from any damage.

Standard accessories are not covered by warranty of this instrument.

AA-size alkaline batteries		4 pieces
Test leads	(98073)	1 set
Lead cables	(98064)	1 set
Fuses (inside the CA450)	(99042) 440 mA/1000 V	2 pieces
User's manual		1 copy
Blank cover		1 piece

Regarding Safe Use of This Product

This product is designed to be used by a person with specialized knowledge. When operating the instrument, be sure to observe the cautionary notes given below to ensure correct and safe use of the instrument.

If you use the instrument in any way other than as instructed in this manual, the instrument's protective measures may be impaired.

This manual is an essential part of the product; keep it a safe place for future reference.

YOKOGAWA is by no means liable for any damage resulting from use of the instrument in contradiction to these cautionary notes.

The following safety symbols are used on the instrument and in the manual:



WARNING

This indicates that the operator must refer to an explanation in the instruction manual in order to avoid the risk of serious injury or the loss of life.



CAUTION

This indicates that the operator must refer to an explanation in the instruction manual in order to avoid the risk of injury or damage to the product.



Note

This indicates information that is essential for handling the instrument or should be noted in order to familiarize yourself with the instrument's operating procedures and/or functions.

Tip

This indicates supplemental information for explanations.



Danger! Handle with Care

This symbol indicates that the operator must refer to an explanation in the instruction manual in order to avoid risk of injury or death of personnel or damage to the instrument.



This symbol indicates double insulation or reinforced insulation.



This symbol indicates DC voltage/current.



This symbol indicates AC voltage/current.



This symbol indicates AC and DC.



This symbol indicates a fuse.



This symbol indicates a battery.



This symbol indicates ground (earth).

■ **Always observe the following instructions.**

Failure to do so may result in electrical shock or other dangers that may lead to serious injury or the loss of life.



WARNING

Use the instrument Only for Its Intended Purpose

This instrument is for measuring voltage or current and generating (output) current. Do not use this instrument for other purpose.

Check the Physical Appearance

Do not use the instrument if there is a problem with its physical appearance.

Operating Environment

- Do not operate the instrument in an atmosphere where any flammable or explosive gas is present.
 - Avoid using the instrument if it has been exposed to rain or moisture or if your hands are wet.
-
-



WARNING

Test Leads and Lead cables

- Use the products provided by YOKOGAWA for this device.
- Do not use degraded or damaged test leads or lead cables.
Check the continuity of the test leads and lead cables.
- When you attach or remove the test leads or lead cables or remove the case (for example to change the batteries), be sure to remove the lead cables from the circuit under measurement.
- When you remove the case (for example to change the batteries), be sure to remove the test leads and lead cables from the instrument.
- There are caps at the ends of the test leads.
To ensure safety (safety standard EN 61010-031), be sure to put the caps on the leads when you use them.

Damaged Signal Cable

If the signal cable (test leads and lead cables) is torn and the inner metal is exposed or if a color different from the outer sheath appears, stop using the cable immediately.

Casing

Do not use the instrument if there is any damage to the casing or when the casing is removed.

Fuses

Use fuses of the specified rating when the fuse is replaced.

Do Not Remove the Case or Disassemble

Do not open the case except when replacing batteries or fuse.

Only Yokogawa service personnel are authorized to remove the casing or disassemble or modify the instrument.

Do not attempt to repair the instrument yourself, as doing so is extremely dangerous.

When the instrument needs an internal inspection or calibration, contact YOKOGAWA or the dealer from whom you purchased the instrument.



CAUTION

The instrument is for domestic use (Class B) and meets the electromagnetic compatibility requirements.

Concernant l'usage en toute sécurité de ce produit

Dans le cadre de l'utilisation de cet instrument, assurez-vous de respecter les mises en garde indiquées ci-dessous pour garantir une utilisation correcte et sans danger de l'instrument. Si vous utilisez l'appareil d'une autre manière que celle indiquée dans ce manuel, il est possible que cela endommage les dispositifs de protection.

YOKOGAWA ne saurait en aucun cas être déclaré responsable de tout dommage résultant d'une utilisation de l'instrument ne respectant pas ces mises en garde.

Symboles utilisés sur l'instrument et dans ce manuel d'instructions:



AVERTISSEMENT

Indique un danger. Attire l'attention sur une utilisation qui pourrait engendrer des accidents susceptibles de provoquer des blessures qui peuvent éventuellement s'avérer mortelles.



ATTENTION

Indique un danger. Attire l'attention sur une utilisation qui pourrait engendrer une blessure personnelle et/ou être préjudiciable au produit.



Remarque

Indique les informations essentielles à la manipulation de l'instrument ou qui doivent être prises en compte afin de vous familiariser avec les procédures d'utilisation et/ou les fonctions de l'instrument.

Conseil

Ce qui suit indique des informations supplémentaires pour les explications.



Danger ! Manipuler avec soin.

Ce symbole indique que l'opérateur doit se reporter à une explication donnée par le manuel d'instruction, afin d'éviter tout accident susceptible de provoquer des blessures au personnel qui peuvent éventuellement s'avérer mortelles, ou de protéger l'appareil.



Ce symbole indique une double isolation ou une isolation renforcée.



Ce symbole indique une tension/intensité C.C.



Ce symbole indique une tension/intensité C.A.



Ce symbole indique le C.A. et le C.C.



Ce symbole indique un fusible.



Ce symbole indique une batterie.



Ce symbole indique la masse (terre).

- **Les précautions suivantes doivent être prises. Dans le cas contraire, des accidents susceptibles de provoquer des blessures qui peuvent éventuellement s'avérer mortelles résultant de dangers tels que des chocs électriques, ou un préjudice au produit, risquent de survenir.**



AVERTISSEMENT

Utilisez cet instrument uniquement pour l'usage auquel il est destiné.

Cet instrument est destiné à mesurer une tension ou un courant et à générer du courant (sortie). N'utilisez pas cet instrument à d'autres fins.

Vérifiez l'aspect physique

N'utilisez pas cet instrument si son aspect physique présente un problème.

Environnement d'opération

- N'utilisez pas l'instrument là où un gaz ou de la vapeur (atmosphère) inflammable ou explosive quelconque est présente.
 - Évitez d'utiliser l'instrument s'il a été exposé à la pluie ou à l'humidité ou si vos mains sont humides.
-
-



AVERTISSEMENT

Fils de test et câbles de dérivation

- Utilisez les produits fournis par YOKOGAWA pour ce dispositif.
- N'utilisez pas de fils de test ou de câbles de dérivation dégradés ou endommagés.
Vérifiez la continuité des fils de test et des câbles de dérivation.
- Lorsque vous fixez ou retirez les fils de test ou les câbles de dérivation, ou que vous enlevez le boîtier (par exemple pour changer les batteries), veillez à retirer les fils de test et les câbles de dérivation du circuit en cours de mesure.
- Lorsque vous enlevez le boîtier (par exemple pour changer les batteries), veillez à retirer les fils de test et les câbles de dérivation de l'instrument.
- Un chapeau est fourni sur le bout d'un fil de test.
Utilisez un fil de test avec le chapeau placé dessus pour une bonne sécurité (normes de sécurité: EN 61010-031).

Câble de signal endommagé

Si le câble de signal (des fils de test et des câbles de dérivation) est déchiré et que le métal intérieur est exposé ou si une couleur différente de la gaine externe est visible, arrêter immédiatement d'utiliser ce câble.

Boîtier

N'utilisez pas l'instrument s'il y a un dommage quelconque au boîtier ou quand le boîtier est enlevé.

Fusibles

Utilisez les fusibles avec l'évaluation spécifiée quand le fusible est remplacé.

Ne retirez pas le boîtier, ne le démontez pas.

N'ouvrez pas le boîtier, sauf pour remplacer la batterie ou un fusible. Seul le personnel qualifié de YOKOGAWA est habilité à retirer le boîtier et démonter ou modifier l'instrument. N'essayez pas de réparer/modifier l'instrument vous-même, car cela est extrêmement dangereux.

Pour un contrôle interne ou un étalonnage de l'instrument, contacter YOKOGAWA ou le revendeur auprès duquel a été acheté l'instrument.



ATTENTION

Cet instrument est destiné à un usage domestique (classe B) et respecte les exigences en matière de compatibilité électromagnétique.

Contents

Introduction	i
Checking the Contents of the Package	ii
Regarding Safe Use of This Product	iii
Concernant l'usage en toute sécurité de ce produit	vi
1. Overview	1
2. Operating Environment	2
3. Specifications	4
3.1 General Specifications	4
3.2 Accuracy	7
4. Operation	10
4.1 Precautions before Measurement	10
4.2 Components	11
4.3 Measuring Instructions	18
4.3.1 AC Voltage Measurement ($\sim V$, $\sim mV$)	18
4.3.2 DC Voltage Measurement ($\equiv V$, $\equiv mV$)	18
4.3.3 Measuring Using Sensors (SENSOR)	19
4.3.4 Resistance Measurement (Ω)	20
4.3.5 Continuity Check ($\bullet $)	21
4.3.6 Diode Test (\blacktriangleleft)	21
4.3.7 DC Current Measurement (\overline{mA})	23
4.3.8 Loop Power Measurement	25
4.3.9 Frequency Measurement (Hz)	26
4.3.10 Auto Hold Function	27
4.3.11 Peak Hold Function	27
4.3.12 Relative Value Display (REL Δ / %)	29
4.3.13 MIN/MAX/AVG Function	30
4.4 Output Instructions	31
4.4.1 Constant Current Output (SOURCE mode)	32
4.4.2 Constant Current Output (SIMULATE mode)	34
4.4.3 Current Sweep Output	36
4.4.4 Current Span Setting	38
4.5 Auto Power-Off (Sleep) Function	38

4.6	Setup Function	39
4.6.1	Turning the Buzzer On and Off	40
4.6.2	SENSOR Mode Input, Display, and Unit Settings	41
4.6.3	Current Span Setting for the 100 mA Range for DCmA Measurement	42
4.6.4	Setting the Slow Step Time	43
4.6.5	Returning the Settings to Their Factory Default Values	43
4.7	Additional Power-on Functions	44
4.7.1	Making All the LCD Elements Appear	44
5.	User Calibration Function	45
5.1	Calibrating Measurements	46
5.1.1	Peak Hold Calibration	48
5.1.2	Loop Power Calibration	48
5.2	Calibrating Output	49
5.3	What to Check after Calibration	51
6.	Communication	52
6.1	Cable Connection and Interface Specifications	52
6.2	Communication Commands	53
6.3	Detailed Command Descriptions	55
6.4	List of Errors	73
6.5	Communication Command Validity Table	74
6.6	Status Byte Format	76
7.	Replacing the Batteries and Fuses	77
7.1	Replacing the Batteries	77
7.2	Replacing the Fuses	78
8.	Calibration and After-Sales Service	79
9.	Troubleshooting	81
10.	Sales in Each Country or Region	82
10.1	Disposing the Product	82
10.2	How to Replace and Dispose the Batteries	82
10.3	Authorized Representative in the EEA	82
10.4	For the Pollution Control of Electronic and Electrical Products of the People's Republic of China	83
	Appendix (External Dimensions)	84

1. Overview

- **Display**

Main display: 5-digit LCD, Subdisplay: 5-digit LCD
(Measured values other than current values are displayed with 4 digits.)

- **Various Functions**

Measurement Functions

DC voltage, AC voltage, DC current (24 V loop power supply possible), resistance, frequency, continuity check, and diode test

Output Functions

DC current (constant output, current sweep output, and SIMULATE (SINK) function)

Additional Functions

Data hold (D•H); auto hold (A•H); peak hold (P•H); auto range (Auto); range hold (Range Hold); maximum, minimum, and average value recording and measurement; zero adjustment (Ω); relative measured value display (REL Δ , REL%); and backlight

- **Communication (Optional PC communication set required)**

Measurement data can be transferred to a PC through the use of a USB communication adapter and a USB cable.

- **Safety**

Conforms to IEC 61010-1, Safety requirements for electrical equipment for measurement, control, and laboratory use.

“Safety requirements for electrical equipment for measurement, control, and laboratory use”

This instrument uses a current-input terminal shutter for preventing wrong input. This instrument uses high-performance UL-standard fuses.

2. Operating Environment

■ Measurement Category

Measurement Category	Description	Remarks
O (None, Other)	Other circuits that are not directly connect to MAINS.	Circuits not connected to a mains power source
CAT II	For measurements performed on circuits directly connected to the low-voltage installation	Appliances, portable equipment, etc.
CAT III	For measurements performed in the building installation.	Distribution board, circuit breaker, etc.
CAT IV	For measurements performed at the source of the low-voltage installation.	Overhead wire, cable systems, etc.



WARNING

■ Measurement Category of CA450

There are restrictions on the maximum voltage level at which the CA450 can be used. These restrictions are based on the measurement categories specified by the safety standards.

AC/DC 1000 V CAT III, AC/DC 600 V CAT IV

Current measurement and output:

Measurement category O (Other) 48 Vmax 100 mAmax

■ Category of Lead cables (98064)

Measurement category O (Other) DC 70V 100 mA

■ Category of Test leads (98073)

With Caps: 1000V 10A CAT III/600V 10A CAT IV

Without Caps: 1000V 10A CAT II

When you use the test leads, attach or remove the caps according to the measurement category.



CAUTION

The instrument is for domestic use (Class B) and meets the electromagnetic compatibility requirements.



Note

Radiation immunity affects electrical performance (accuracy) under the conditions in EN 61326-1 and EN 61326-2-2.

The use of this instrument is limited to domestic, commercial, and light industry applications.

The instrument may malfunction if it is exposed to strong electromagnetic interference from nearby devices.

Operating Environment and Conditions

This instrument complies with the EMC standard under specific operating environment and operating conditions.

If the installation, wiring, and so on are not appropriate, the compliance conditions of the EMC standard may not be met.

In such cases, the user will be required to take appropriate measures.

■ Operating Environment

Do not use the instrument in the following locations:

- Outdoors
- In direct sunlight or near heat sources
- Where the instrument is exposed to water or other liquids
- Where there is a lot of mechanical vibration
- Near noise sources such as high-voltage equipment or power lines
- Near strong magnetic field sources
- Where an excessive amount of greasy fumes, steam, dust, or corrosive gases are present
- In an unstable place
- Where, for example, fire and explosions caused by inflammable gases and the like are possible

3. Specifications

3.1 General Specifications

Measurement functions: DC voltage, AC voltage, DC current, resistance, frequency, continuity check, diode test

Additional functions: Data hold (D•H); auto hold (A•H); peak hold (P•H); auto range (Auto); range hold (Range Hold); maximum, minimum, and average value recording and measurement; zero adjustment (Ω); relative measured value display (REL \triangleleft , REL%); 24 V loop power supply; internal resistor on/off for HART communication

Output functions: 20 mA DC current for current output SOURCE and current output SIMULATE (SINK)

Additional functions: Current span switching and current sweep output

Operation methods: Measurement: \triangleleft Σ modulation
Output: Multiplicative DA

Display: 5-digit LCD (7 segment)
Numeric display

Measurement	Output
DC current: 33000	DC current: 25000
Frequency: 19999	---
Other: 6600	---

Subdisplay Displays supplemental information for various functions

Polarity indicator Automatic display. Only the minus sign “-” appears.

Over range indicator “OL”

Low-battery indicator  appears when the battery voltage is below the operating voltage.

Measurement cycle: 2.5 to 5 times a second
(however, frequency measurement takes place once a second)

Operating temperature and humidity:	-20°C to 55°C (80% RH or less) with no condensation Within the range of 40°C to 55°C, the humidity must be 70% RH or less.	
Storage temperature and humidity:	-40°C to 70°C (70% RH or less) with no condensation	
Temperature coefficient (typ.):	In the ranges of -20°C to 18°C and 28°C to 55°C, add the accuracy of $23^{\circ}\text{C} \pm 5^{\circ}\text{C} \times 0.1/^{\circ}\text{C}$.	
Power supply:	Four AA-size alkaline batteries (1.5 V LR6)	
Battery life:	When using alkaline batteries	
	DC voltage measurement:	Approx. 140 hours
	DC current output (SIMULATE):	Approx. 140 hours
	DC current output (SOURCE) 12 mA (500 Ω load):	Approx. 10 hours
Insulation resistance:	100 MΩ or greater at 1000 VDC	
Withstand voltage:	6.88 kVAC for five seconds (between the input terminals and the case)	
External dimensions:	Approx. 90 (W) × 192 (H) × 49 (D) mm (For external dimensions, see Appendix.)	
Weight:	Approx. 600 g (including the batteries)	
Standard accessories:	AA-size alkaline batteries	4 pieces
	Test leads (98073)	1 set
	Lead cables (98064)	1 set
	Fuses (99042)	2 pieces
	440 mA/1000 V (inside the CA450)	
	User's manual	1 copy
	Blank cover	1 piece
Optional accessories:	Carrying case (93029)	1 piece
	(for carrying the CA450, the test leads, and the lead cables)	
	Carrying case (93043-P1)	1 piece
	Test leads (98073)	1 set
	Lead cables (98064)	1 set
	Alligator test leads (99014)	1 set
	Fuse 440 mA/1000 V (99042)	2 pieces
	Communication Package (92015)	1 set
	(USB adapter, USB cable and software)	
	1 to 5V Adapter set (99031)	1 set
	(250 Ω resistor, terminal adapters and leads)	
	AC/DC clamp-on probe (96095)	1 piece
	Clamp-on probe for current (96001)	1 piece

Safety standards:	EN 61010-1, EN 61010-2-030, EN 61010-2-033, EN 61010-031
Measurement Categories:	1000 V CATIII, 600 V CATIV
	For current measurement and output: 48 V max, 100 mA max
	Measurement category O (Other)
	Lead cables (98064): 70 VDC, 100 mA
	Measurement category O (Other)
	Indoor use, altitude: 2000 m or less, pollution degree 2
Vibration:	Sweep vibration frequencies 10 Hz to 55 Hz to 10 Hz
	Amplitude 0.15 mm (peak value)
	Duration 30 minutes
Shock:	1 m drop test as defined by the safety standards
EMC standards:	EN 61326-1 Class B, EN6 1326-2-2
	EN 55011 Class B Group 1
	EMC Regulatory Arrangement in Australia and New Zealand
	EN 55011 Class B Group 1
	Korea Electromagnetic Conformity Standard
	(한국 전자파적합성기준)
Influence of radiated immunity:	In RF electromagnetic fields of 3 V/m
	EN 61326-1
	AC voltage measurement, 600 mV range: 1.5% of range
	DC voltage measurement, 600 mV range: 1% of range
	DC current measurement, all ranges: 1.5% of range
	DC current output: 1.5% of range
	EN 61326-2-2
	AC voltage measurement (6 V range or higher):
	Within 5 times the accuracy
	DC voltage measurement (6 V range or higher):
	Within 5 times the accuracy
Environmental standard	EN 50581
	Monitoring and control instruments including industrial monitoring and control instruments

3.2 Accuracy

Standard test conditions

- (1) Ambient temperature: $23^{\circ}\text{C} \pm 5^{\circ}\text{C}$
- (2) Relative humidity: 45% to 75% RH (no condensation)
- (3) Orientation: Horizontal or standing
- (4) External magnetic fields: Terrestrial magnetic field only

Accuracy: \pm (% of reading + digits)

* Each of the response times indicates the time it takes for the accuracy to fall within the specified range.

DC Voltage Measurement (---V , ---mV)

Range	Resolution	Accuracy	Input Resistance	Maximum Input Voltage
600 mV	0.1 mV	0.09% + 2	10 M Ω or more	1000 VDC
6 V	0.001 V	0.09% + 1	Approx. 11 M Ω	
60 V	0.01 V		Approx. 10 M Ω	1000 Vrms AC
600 V	0.1 V			
1000 V	1 V	0.1% + 1		

NMRR: 60 dB or more, 50/60 Hz \pm 0.1%

CMRR: 120 dB or more, 50/60 Hz ($R_s = 1 \text{ k}\Omega$)

Response time: Within 1 second

AC Voltage Measurement ($\sim\text{V}$, $\sim\text{mV}$)

AC coupling, rms value detection: sine wave

Range	Resolution	Accuracy			Input Impedance	Maximum Input Voltage
		50/60 Hz	40 Hz to 500 Hz	500 Hz to 1 kHz		
600 mV	0.1 mV	0.5% + 5	1% + 5	1.5% + 5	10 M Ω or more, <200 pF	1000 VDC
6 V	0.001 V				Approx. 11 M Ω , <50 pF	
60 V	0.01 V				Approx. 10 M Ω , <50 pF	
600 V	0.1 V			1000 V rms AC		
1000 V	1 V			—		

For a range of 5 to 100%, the accuracy for the 1000 V range is 200 V to 1000 V

CMRR: 60 dB or more, DC to 60 Hz ($R_s = 1 \text{ k}\Omega$)

For nonsinusoidal waveforms whose crest factor is less than 3, add \pm (2% of reading + 2% of range) to the accuracy.

For the 1000 V range, the peak voltage is 1500 V or less

Response time: Within 2 seconds

DC Current Measurement (\overline{mA})

Range	Resolution	Accuracy	Voltage Drop
30 mA	0.001 mA	0.05% + 2	< 0.3 V
100 mA *1	0.01 mA	0.05% + 2	< 0.8 V

*1 Only the 30 mA range can be used during LOOP POWER output.

Response time: Within 1 second

Resistance Measurement (Ω)

Range	Resolution	Accuracy	Maximum Measuring Current	Open-Loop Voltage	Input Protective Voltage
600 Ω	0.1 Ω	0.2% + 2	<1.2 mA	<3.5 V	1000 Vrms
6 k Ω	0.001 k Ω	0.2% + 1 *1	<110 μ A	<1.3 V	
60 k Ω	0.01 k Ω		<13 μ A		
600 k Ω	0.1 k Ω		<1.3 μ A		
6 M Ω	0.001 M Ω	0.35% + 3	<130 nA		
60 M Ω	0.01 M Ω	1% + 2 *2			

*1 The accuracy after ZERO CAL

*2 For 40 M Ω to 60 M Ω , the accuracy is 2% + 2.

Response time:

Within 2 seconds for 600 Ω to 600 k Ω , within 10 seconds for 6 M Ω to 60 M Ω

Continuity Check (\bullet)

Range	Resolution	Operating Range	Measuring Current	Open-Loop Voltage	Input Protective Voltage
600 Ω	0.1 Ω	The buzzer sounds at resistances lower than 50 \pm 30 Ω .	<1.2 mA	< 3.5 V	1000 Vrms

Diode Test (\rightarrow)

Range	Resolution	Accuracy	Measuring Current (Vf = 0.6 V)	Open-Loop Voltage	Input Protective Voltage
2 V	0.001 V	1% + 2	Approx. 0.5 mA	<3.5 V	1000 Vrms

Frequency Measurement (Hz)

AC Coupling

Range	Resolution	Accuracy	Input Voltage Range
10.00 Hz to 199.99 Hz	0.01 Hz	0.005% + 1	0.3 to 600 Vrms
90.0 Hz to 1999.9 Hz	0.1 Hz		
0.900 Hz to 19.999 kHz	0.001 kHz		0.4 to 600 Vrms

Peak Hold (P•H)

Measurement Function	Accuracy	Minimum Detection Width
DCV	±100 digits	>6 ms

DC Output ($\downarrow \overline{\overline{mA}}$)

Range	Resolution	Accuracy	Load Condition
20 mA	0.001 mA	0.05% of range	SOURCE 0 to 20 mA Compliance voltage 28 V SIMULATE (SINK) 0 to 20 mA External power supply 15 to 48 V overrange up to 25 mA < 10 mH

24 V Loop Power Supply (LOOP POWER)

Range	Load Condition
24 V	24 VDC (typ.), load current 20 mA

4. Operation

4.1 Precautions before Measurement

■ Operation and Storage Precautions



CAUTION

- When inserting the batteries into the instrument, refer to section 7.1, "Replacing the Batteries."
- There is a blank cover on the upper part of the back casing.
Only remove it when connecting the USB adapter of the communication package (sold separately).
- Do not use the instrument near devices that produce high levels of noise or in areas subject to sudden changes in temperature.
Doing so may result in unstable readings and errors.

Cleaning

- Do not wipe the instrument using benzene, paint thinner, or any other solvent (chemical).
Doing so may lead to discoloration and other problems.
Use a dry cloth to clean the instrument.

Storage

- Do not leave the instrument exposed to direct sunlight or in a hot and humid location, such as the inside of a vehicle, for a significant length of time.
 - If you do not intend to use the instrument for a significant period of time, remove its batteries.
-

■ Turning the Power On and Off



CAUTION

To verify the instrument's functionality, check that the measured value is updated after turning on the power. If the measured value is not updated, the reading will be incorrect and may lead to possible electrical shock or personal injury.

Turn the function switch from the OFF position to the measurement range position. The power turns on. After measuring, turn the function switch off.
(If test leads or lead cables are connected to the current measurement and output terminals, you cannot turn the function switch to the OFF position.)

4.2 Components

■ CA450

Front Panel

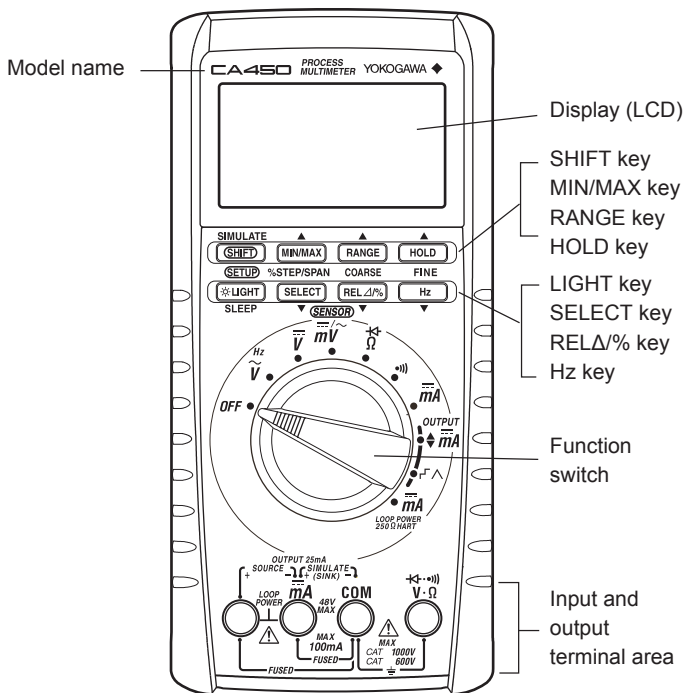

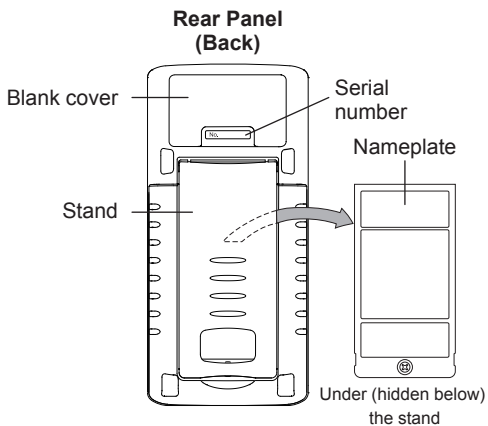

■ Test leads (98073)

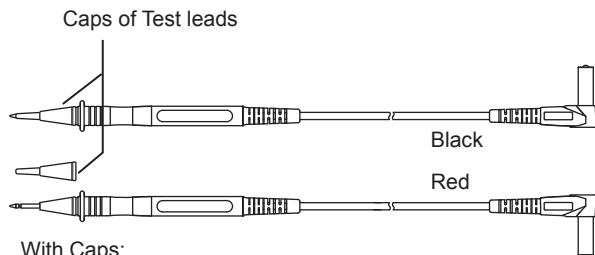

With Caps:
1000V 10A CAT III/600V 10A CAT IV





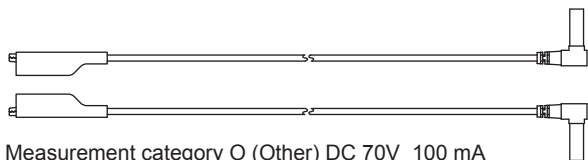





Without Caps:
1000V 10A CAT II

■ Lead cables (98064)



(1) Function switch

Use this switch to turn the power on and off and to select the measurement mode.

Function	Mode	Function	Mode
OFF	Turns the CA450 off.		Continuity check
 V / Hz	AC voltage measurement and frequency measurement		DC current measurement
 V	DC voltage measurement	OUT PUT	 DC current output Constant current output
 mV /  mV SENSOR	DC/AC voltage measurement in mV and various SENSOR modes		
Ω / 	Resistance measurement Diode test		DC current measurement Loop power supply

If test leads or lead cables are connected to the current measurement and output terminals, you cannot turn the function switch to the OFF position.

(2) SELECT key

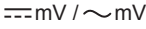

By pressing this key, you can select different measurement modes when the function switch is at the positions listed below.

You can switch out of the selected mode by pressing the key again.

 position: AC voltage mV measurement
(AC SENSOR measurement in SENSOR mode)

Ω /  position: Diode test

 LOOP POWER position: The SELECT key turns the internal series resistor for HART communication on and off.

 position: Operation mode switching
(, SLOW/FAST)

(3) RANGE key

Use this key to select the measurement range.

Fixed range: "Range Hold" appears on the display.
The range increases each time you press RANGE.

AUTO range: "AUTO" appears on the display.
To select AUTO range, hold down RANGE for 1 second or longer.

(4) HOLD key

Use this key to hold the measured values.

Press HOLD to switch between data hold, auto hold, peak hold, and no hold (release).

(Hold modes that are not supported for the selected measurement function are skipped.)

Data hold:	The currently displayed measured values are held. "D•H" appears on the display.
Auto hold:	The measured values are automatically held according to the operation of the test leads. "A•H" appears on the display.
Peak hold	The peak values are held. "P•H" appears on the display.

(5) LIGHT key

Use this key to turn the backlight on and off.

Press the key once to turn it on. Press it again to turn it off.

Use this key to control the sleep function.

During measurement or output, Hold down LIGHT for 2 seconds or longer to put the CA450 in sleep mode. (While the CA450 is in sleep mode, hold down the LIGHT key for 2 seconds or longer to clear sleep mode.)

(You cannot clear sleep mode immediately after the CA450 is put in sleep mode. Wait at least 2 seconds after the CA450 is put in sleep mode before you clear it.)

(6) REL Δ /% key

Use this key to display the measured values as relative values

(you can display the differences between values using numbers or percentages).

- 1: Difference display (REL Δ) " Δ " appears on the display.
- 2: Percentage difference (REL%) " Δ " and " % " appear on the display.
display

Use this key during the zero adjustment of the resistance measurement function. With the test leads shorted, press the REL key to execute zero adjustment.

(7) MIN/MAX key

Use this key to display the minimum (MIN), maximum (MAX), and average (AVG) values within the measurement period.

When you press the key, recording starts, and "MIN," "MAX," and "AVG" appear on the display.

(The AUTO OFF function is disabled.) When peak hold is enabled, press the REL key to reset the peak value.

(8) Hz key

When the function switch is turned to $\sim V$, use this key to switch between AC voltage measurement and frequency measurement.

Use this key in calibration mode to confirm the calibration value.

(9) SHIFT key

If you press SHIFT while a measurement mode is selected,

"Shift" appears on the display.

In this state, you can configure various settings by pressing the various keys.







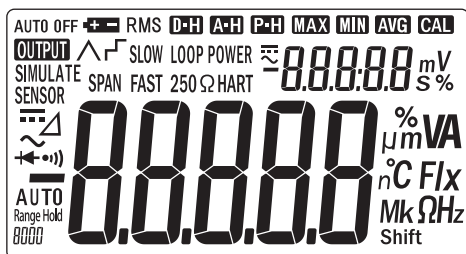

SHIFT +	LIGHT key	SETUP mode
	SELECT key	Switches from mV mode to SENSOR mode

While an output mode is selected, press SHIFT to switch between SOURCE and SIMULATE.

■ Display (LCD) Description



Symbol or Unit	Description
	Appears during DC measurement or output
	Appears during AC measurement
	Appears when the polarity is negative (minus)
	Appears during diode test mode
	Appears during continuity check mode
	Appears when relative values are being displayed
Range Hold	Indicates that the measurement range is set to fixed
AUTO	Indicates that the measurement range is set to auto
8888	Indicates the present range
D·H	Appears when data hold is enabled
A·H	Appears when auto hold is enabled
P·H	Appears when peak hold is enabled
MAX MIN AVG	Appears when the MIN, MAX, and AVG values are being measured
MAX	Appears when the MAX value is being displayed
MIN	Appears when the MIN value is being displayed
AVG	Appears when the AVG value is being displayed
CAL	Appears when user calibration is being performed
AUTO OFF	Appears when the auto power-off function is enabled
RMS	Appears during rms value detection
Shift	Appears when SHIFT has been pressed

Symbol or Unit	Description
	Shows the main value Shows the input or output value A converted value is shown in SENSOR mode
$\%VA$ μmVA $nC Flx$ $Mk\Omega Hz$	Indicates the main unit
mV $S\%$	Indicates the subunits Shows the MIN, MAX, and AVG recording time Shows the input voltage unit in SENSOR mode
	Shows the subvalue Shows the MIN, MAX, and AVG recording time Shows the reference value during relative calculation
	Appears when the range has been exceeded
	Appears when the battery voltage is low
OUTPUT	Appears during current output
	 SLOW Shows the current sweep output or step output status Appears during slow linear output
	 FAST Appears during fast linear output
	 SLOW Appears during slow step output
	 FAST Appears during fast step output
LOOP POWER	Appears in loop power supply mode
250 Ω HART	Appears when the internal resistor for HART communication is on
SPAN	Appears in SPAN check mode
SIMULATE	Appears when the SIMULATE operation is being performed
SENSOR	Appears in SENSOR mode

4.3 Measuring Instructions

WARNING

To avoid damaging the instrument and other equipment:

- Before you start measuring, make sure that the position of the function switch and position of the input terminals for connecting the test leads or lead cables are appropriate for the desired mode of measurement.
(Check that they are appropriate for the measurement category.)
 - Before you turn the function switch, remove the test leads or lead cables from the circuit under measurement.
 - Before you use this instrument or use its indications as a reference for further procedures, make sure that the instrument functions properly when used with a known power supply.
-

4.3.1 AC Voltage Measurement ($\sim V$, $\sim mV$)

- 1) Turn the function switch to the " $\sim V$ " or "mV" position.
- 2) If you turned the function switch to "mV," press SELECT. (" \sim " is displayed.)
- 3) Insert the test leads into the input terminals.
- 4) Connect the test leads to the circuit under measurement, and then read the value when it stabilizes.

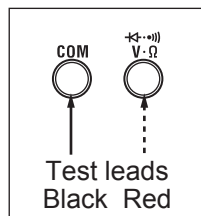

4.3.2 DC Voltage Measurement ($\approx V$, $\approx mV$)

- 1) Turn the function switch to the " $\approx V$ " or "mV" position.
- 2) Insert the test leads into the input terminals.
- 3) Connect the test leads to the circuit under measurement, and then read the value when it stabilizes.

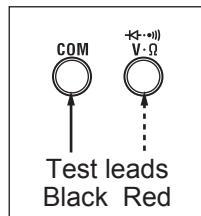

Note

If the $\approx mV$ or $\sim mV$ range setting is selected and the test leads are not connected to a circuit, the instrument will still display a value, but measurement will not be adversely affected.

4.3.3 Measuring Using Sensors (SENSOR)

You can use this function to measure the output of a current sensor or other type of sensor that converts its measured values into voltages, to convert the voltages into the original measured values, and to display the converted values.

Before you perform measurement, you need to configure unit, conversion, and other settings.

See section 4.6.2 “SENSOR Mode Input, Display, and Unit Settings.”

- 1) Turn the function switch to the “mV” position.
- 2) Press SHIFT+SELECT to switch to DC SENSOR mode.

To switch to AC SENSOR mode, press SELECT again.

The input voltage appears in the subdisplay.

In the main display, the value converted using the settings configured in section 4.6.2 “SENSOR Mode Input, Display, and Unit Settings.”

DC SENSOR range



AC SENSOR range

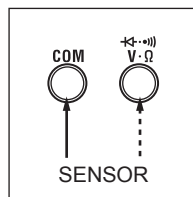
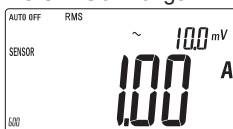

- 3) Connect the sensor that you will use to the input terminals.
- 4) Read the value when it stabilizes.

To return to normal mV measurement, press SHIFT+SELECT again.

Example of measurement when connecting a current clamp sensor with an input-to-output ratio of 10 mV/A

Use the setup function (see section 4.6) to configure the following settings.

Instrument input voltage:	10.0 (mV)
Converted value, decimal place:	01.00
Unit:	A

If you connect the sensor after configuring the above settings, the current clamp sensor's output voltage (in mV) appears in the subdisplay, and the current detected by the current clamp sensor appears in the main display. (You can read the values directly.)

4.3.4 Resistance Measurement (Ω)

CAUTION

To avoid damaging the instrument:

Before measurement, turn off the circuit under measurement so that no voltage is applied.

- 1) Turn the function switch to the " Ω " position.
- 2) Insert the test leads into the input terminals.
- 3) Connect the test leads to the circuit under measurement, and then read the value when it stabilizes.

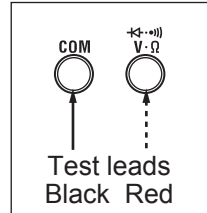

Note

Zero adjustment for resistance

We recommend that you perform zero adjustment to obtain accurate measurements.

After you perform steps 1) and 2) above, short the test leads, and press the REL key.

(When zero adjustment is performed, the instrument will show a reading of 0.0 Ω .)

The zero adjustment value is used until the power is turned off.

4.3.5 Continuity Check (•|))

CAUTION

To avoid damaging the instrument:

Before measurement, turn off the circuit under measurement so that no voltage is applied.

- 1) Turn the function switch to the “•|))” position.
- 2) Insert the test leads into the input terminals.
- 3) Connect the test leads to the circuit under measurement whose continuity you want to check.
If the circuit is continuous
(less than approximately 50Ω), the buzzer sounds.

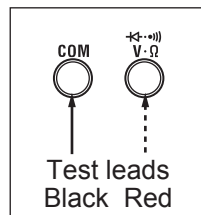

4.3.6 Diode Test (↵)

CAUTION

To avoid damaging the instrument:

Before measurement, turn off the circuit under measurement so that no voltage is applied.

- 1) Turn the function switch to the “Ω” position.
Press SELECT to switch to diode measurement.
(↵ is displayed.)
- 2) Insert the test leads into the input terminals.
- 3) Connect the test leads to the diode, and then read the value when it stabilizes.

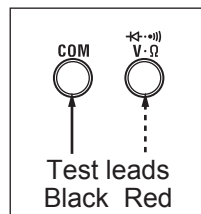

Forward-Bias Diode Test

Connect the black test lead to the cathode, and connect the red test lead to the anode.

For a silicon diode, the reading should be approximately 0.5 V.

For an LED, the reading should be approximately 1.5 V to 2.0 V.

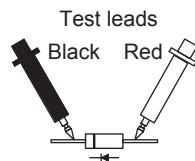

Figure 1
Forward-bias test

Reverse-Bias Diode Test

Connect the black test lead to the anode, and connect the red test lead to the cathode.

Normally, "OL" appears. If a voltage value appears, the diode is defective.

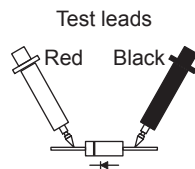

Figure 2
Reverse-bias test

4.3.7 DC Current Measurement (\overline{mA})

WARNING

To avoid damaging the instrument and other equipment:

- Before you start measuring, make sure that the position of the function switch and position of the input terminals for connecting the test leads are appropriate for the desired mode of measurement.

The maximum input current for mA measurement is 110 mA.

- 1) Turn the function switch to the " \overline{mA} " position.
- 2) Connect the black test lead to the COM input terminal, and connect the red test lead to the \overline{mA} input terminal.
- 3) Connect the test leads to the circuit under measurement, and then read the value when it stabilizes.
Press the RANGE key to select a range.

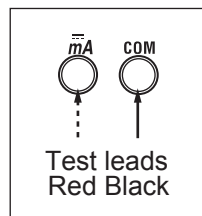

Subdisplay (percentage of span)
When the range is 4 to 20 mA



Main display (30 mA range)

Subdisplay (percentage of span)
When the range is 10 to 50 mA



Main display (100 mA range)

Subdisplay: Displaying and Configuring the Span

In addition to the DC current value in the main display, you can also display the span value as a percentage in the subdisplay.

Subdisplay for the 30 mA Range

Input Current Value (Main display)	Subdisplay for the 30 mA Range	
	4 to 20 mA	0 to 20 mA
-33.000 mA	-231.3%	-165.0%
0.000 mA	-25.0%	0.0%
4.000 mA	0.0%	20.0%
20.000 mA	100.0%	100.0%
30.000 mA	162.5%	200.0%
33.000 mA	181.3%	165.0%

The displayed value varies depending on the setting (4 to 20 mA or 0 to 20 mA) made in section 4.4.4, “Current Span Setting.”

Subdisplay for the 100 mA Range

Input Current Value (Main display)	Subdisplay for the 100 mA Range		
	0 to 100 mA	10 to 50 mA	0 to 50 mA
-110.00 mA	-110.0%	-300.0%	-220.0%
0.00 mA	0.0%	-25.0%	0.0%
10.00 mA	10.0%	0.0%	20.0%
50.00 mA	50.0%	100.0%	100.0%
100.00 mA	100.0%	225.0%	200.0%
110.00 mA	110.0%	250.0%	220.0%

The displayed value varies depending on the setting (0 to 100mA, 10 to 50mA, or 0 to 50mA) made in section 4.6.3, “Current Span Setting for the 100 mA Range for DCmA Measurement.”

4.3.8 Loop Power Measurement

You can use this function to measure the current that flows when a constant voltage of 24 VDC is applied.

24 V loop measurement can be used for transmitter loop testing.

(You can connect the CA450 to the transmitter instead of connecting a transmitter or signal conditioner.)

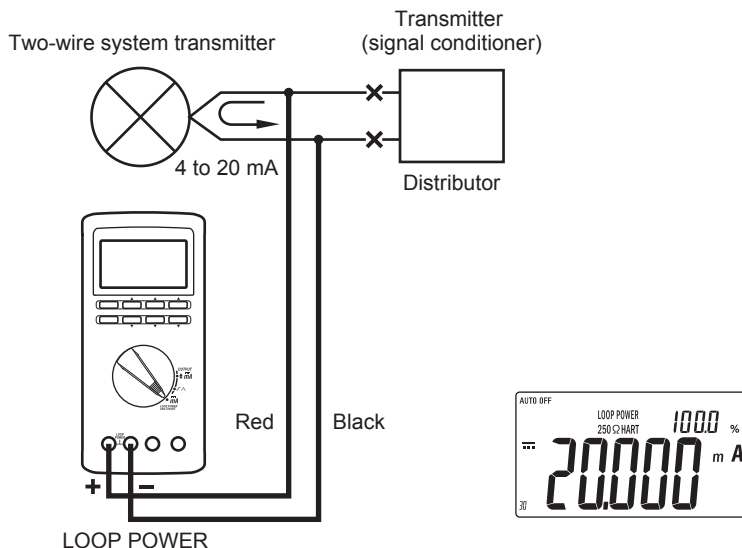

- 1) Turn the function switch to the “ $\overline{\text{mA}}$ LOOP POWER” position.
 (“LOOP POWER” appears on the display.)
 A constant voltage of 24 VDC is output between the “SOURCE (+)” and “SOURCE (-)” measurement terminals.
- 2) Connect the red test lead to “SOURCE (+)” and the black test lead to “SOURCE (-).”
- 3) Connect the test leads to the circuit under measurement, and then read the values when they stabilize.
 Just as in mA measurement, the main display shows the measured value, and the subdisplay shows the value of the measured value divided by the current span times 100 (%).
 (See section 4.3.7 “DC Current Measurement.”)

- 4) Press SELECT to turn the internal 250 Ω series resistor for HART communication on.
("250 Ω HART" appears on the display.)
Press SELECT again to turn the internal resistor off.

Tip

The loop power is supplied at the typical value of 24 VDC.
Depending on different conditions, such as the loop current value or whether there is a internal series resistor,
the voltage across the terminals may be greater than 24 V.

4.3.9 Frequency Measurement (Hz)

- 1) Turn the function switch to the " \sim V" position.
- 2) Press the Hz key to select frequency measurement.
(The measured frequency value and unit appear in the main display, and the measured voltage appears in the subdisplay.)
- 3) Insert the test leads into the input terminals.
- 4) Connect the test leads to the circuit under measurement, and then read the values when they stabilize.

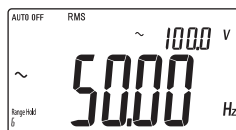
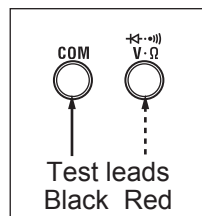

Tip

Note that range hold and selection operations performed using the Range key only apply to the subdisplay (measured voltages).

4.3.10 Auto Hold Function

The CA450 can automatically detect measured values and hold them according to the operation of the test leads.

- 1) During normal measurement, press the HOLD key twice to select "A•H."
("A•H" appears on the display.)
- 2) Connect the test leads to the circuit under measurement.
- 3) When the measured value stabilizes, the buzzer makes a beeping sound.
- 4) Remove the test leads from the circuit under measurement.
- 5) The measured value display is held down.
While "A•H" is displayed, you can repeat steps 2) through 4) as often as you want.



Note

-
- You cannot use this function during DCmV or ACmV measurement (this includes SENSOR mode), frequency measurement, or during a continuity check.
 - You cannot use this function at the same time as the relative value display function or when the MIN, MAX, and AVG values are being recorded.
 - Unstable input signals (measured values) cannot be held.
-

4.3.11 Peak Hold Function

The CA450 always detects and updates the instantaneous peak value during DC voltage measurement (DCV).

You can determine the peak value of a waveform.

- 1) Set the function switch to $\approx V$.
- 2) Connect the test leads to the circuit under measurement.
- 3) Press the HOLD key three times to select "P•H."
("P•H" appears on the display, and the voltage range is fixed.)
- 4) The peak value display is held.
- 5) You can reset the held peak value by pressing the MIN/MAX key.
You can hold a new peak value.



Note

- Even if the polarity of the input signal (DCV) is negative (minus), as long as the peak (change) direction is positive, the peak value can be measured.
 - While the peak value is being measured, you can display relative values based on a measured reference value.
- 1) Press the REL Δ /% key while the peak is held. (“ Δ ” is displayed.)
Main display value: The current peak value – the peak value when the REL key was pressed
 - 2) Press the REL Δ /% key again. (The unit changes to ‘%’.)
Main display value: (The current peak value – the peak value when the REL key was pressed) /the peak value when the REL key was pressed $\times 100$ (%)
 - 3) To no longer show relative values, press REL Δ /% again.
The “ Δ ” and “%” display disappear, and the CA450 returns to the normal peak hold mode.
- You can reset the peak value by pressing MIN/MAX.
You can hold a new peak value.
-

4.3.12 Relative Value Display (REL Δ / %)

The CA450 can calculate and display relative values that represent the difference or percentage from a reference value. (In this display, the range is fixed.)

Difference Display (REL Δ)

The CA450 shows the value of the measured value minus the reference value.

- 1) Measure (input) the reference value.
- 2) Press REL Δ /% to confirm the reference value.
(" Δ " is displayed, and the range is held.)
- 3) Measure (input) the measured values. The displayed values vary depending on the measurement function.

- For DCmA measurement (including loop power measurement):
Main display value: Measured value – reference value
Subdisplay value: (Measured value – reference value)/
current span setting \times 100 (%)
- For measurement types other than DCmA:
Main display value: Measured value – reference value
Subdisplay value: Reference value

Percentage Difference Display (REL%)

The CA450 computes the value of (Measured value – reference value)/reference value and displays the result as a percentage.

- 1) Measure (input) the reference value.
- 2) Press REL Δ /% to confirm the reference value.
(" Δ " is displayed, and the range is held.)
- 3) Press REL Δ /% again. ("% " appears.)
- 4) Measure (input) the measured values.
The displayed values vary depending on the measurement function.

- For DCmA measurement (including loop power measurement):
Main display value: (Measured value – reference value)/
current span setting \times 100 (%)
Subdisplay value: Reference value
- For measurement types other than DCmA:
Main display value: (Measured value – reference value)/
reference value \times 100 (%)
Subdisplay value: Reference value

4.3.13 MIN/MAX/AVG Function

You can use this function to display the minimum (MIN), maximum (MAX), and average (AVG) values within the current measurement period. (In this display, the range is fixed.)

The averaged value that is displayed is the total of the recorded data divided by the number of recorded values.

When you press the MIN/MAX key, recording starts, and "MIN," "MAX," and "AVG" appear on the display. (The AUTO OFF function is disabled.)

Recording Time

The timer starts, and the time from the start of recording is displayed as well as the MIN/ MAX record update time.

The recorded time display shows times in the range of 0 seconds to 99 minutes, 59 seconds in units of seconds.

It shows times greater than 100 minutes in units of minutes.

To stop recording, press the HOLD key. ("D•H" appears on the display.)

Checking the Recording Time

You can check the recorded data by pressing the MIN/MAX key to switch between the display of the current maximum (MAX), minimum (MIN), and average (AVG) values.

To restart recording, press the HOLD key again.

To disable the MIN/MAX/AVG function, hold down MIN/MAX for 1 second or longer. ("MAX," "MIN," and "AVG" disappear.)



Note

-
- While recording is stopped, removing the test leads does not affect the recorded data.
 - When an out-of-range input value is recorded, the minimum or maximum value is displayed as "OL," and the average value data becomes inaccurate.
 - When you are measuring a widely fluctuating signal, set the range to contain the maximum and minimum values so that these values are not displayed as "OL."
-

4.4 Output Instructions

The CA450 can output DC current.

There are two output modes.

SOURCE mode:	Current is supplied from the CA450.
SIMULATE mode (SINK):	The CA450 sinks current from an external voltage source.

There are two configuration modes.

Constant current output:	The specified current is output continuously.
Current sweep output:	The output current is increased and decreased within the specified span.



WARNING

Do not apply a voltage of 48 V or greater to the output terminals. Doing so may lead to electric shock. Also, keep the voltage between the circuit and the ground below 48 V. Always use the attached lead cables and lead cables. (Check that they are appropriate for the measurement category.)



CAUTION

In modes other than SIMULATE mode, do not apply voltages to the output terminals. Mistakenly applying voltage to the output terminals could damage the internal circuitry.

If the  mark appears while you are using the current output function, replace the batteries.

4.4.1 Constant Current Output (SOURCE mode)

- 1) Turn the function switch to the “ $\blacklozenge \overline{\text{mA}}$ ” position.
After you turn the function switch, “OUTPUT” appears on the screen, and the output is set to 0% of the current span setting.
(If you turn the function switch from the “ $\square \wedge$ ” (current sweep) position to the “ $\blacklozenge \overline{\text{mA}}$ ” position, the output value setting and SOURCE/SIMULATE setting are retained.)
- 2) If “SIMULATE” is displayed, press the SHIFT key.
 (“SIMULATE” disappears, the CA450 switches to SOURCE mode, and current output starts.)
- 3) Connect the lead cables to the positive (+) and negative (–) SOURCE terminals.
- 4) Use the output value setting keys to set the output value.
- 5) Connect the lead cables to the circuit under test.

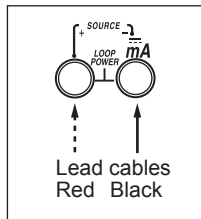
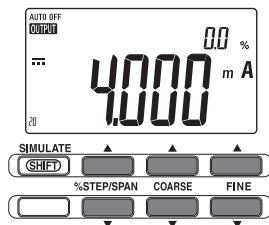

Output Value Setting Key		Output Setting (Increase and decrease)
%STEP *	▲	1-step (25%) increase
	▼	1-step (25%) decrease
COARSE	▲	0.1 mA increase
	▼	0.1 mA decrease
FINE	▲	0.001 mA increase
	▼	0.001 mA decrease

- * For details about using the %STEP key, see “Output Values for Each Step” and “Span Check Mode.”

Tip

- Because the CA45 0 outputs current in SOURCE mode, it consumes more current than in other modes.
You can keep the current consumption down in SIMULATE mode.
- Hold down the %STEP, COARSE, or FINE key to increase or decrease each digit consecutively.

Output Values for Each Step

You can press %STEP▲ or %STEP▼ to increase or decrease the output by one step (25%).

You can check the step value (as a percentage) in the subdisplay.

(The output current appears in the main display.)

Step (Subdisplay)	Output Value	
	4 to 20 mA	0 to 20 mA
-25%	0.000 mA	---
0%	4.000 mA	0.000 mA
25%	8.000 mA	5.000 mA
50%	12.000 mA	10.000 mA
75%	16.000 mA	15.000 mA
100%	20.000 mA	20.000 mA
125%	---	25.000 mA
131.2%	25.000 mA	---

For the method for setting the current span, see section 4.4.4, "Current Span Setting."

Span Check Mode

You can switch the output current between 20 mA and 4 mA (or 20 mA and 0 mA) using just the %STEP keys.

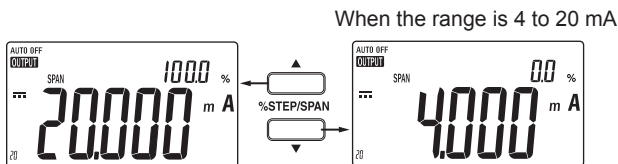

When you hold down %STEP▲ or %STEP▼ for 1 second or longer, “SPAN” appears, and the CA450 enters into span check mode.

In this mode, the output switches to 100% when you press %STEP▲ and to 0% when you press %STEP▼.

Setting Key		Output Setting	
%STEP	▲	20.000 mA (100%)	
	▼	4 to 20 mA 4.000 mA (0%)	0 to 20 mA 0.000 mA (0%)

The COARSE (0.1 mA increase and decrease) and FINE (0.001 mA increase and decrease) keys can also be used.

To exit span check mode, hold down %STEP▲ or %STEP▼ for 1 second or longer again. (“SPAN” disappears.)

Tip

If the set current is 0.1 mA or more and the terminals are open, “-----” appears in the main display, and “----” appears in the subdisplay.

4.4.2 Constant Current Output (SIMULATE mode)

When the SIMULATE (SINK) function is enabled, the CA450 can sink the specified amount of current from an external voltage source (such as a distributor) through the SIMULATE(+) terminal, and you can use the CA450 to simulate a two-wire system transmitter in a loop test.

(You can connect the CA450 instead of a transmitter to test a transmitter or signal conditioner.)



CAUTION

-
- When sinking 20 mA from an external power source, keep the voltage within the range of 15 to 48 V.
 - Set the polarity of the applied voltage as shown in the following figure, and be careful not to apply voltage in the opposite direction.
-

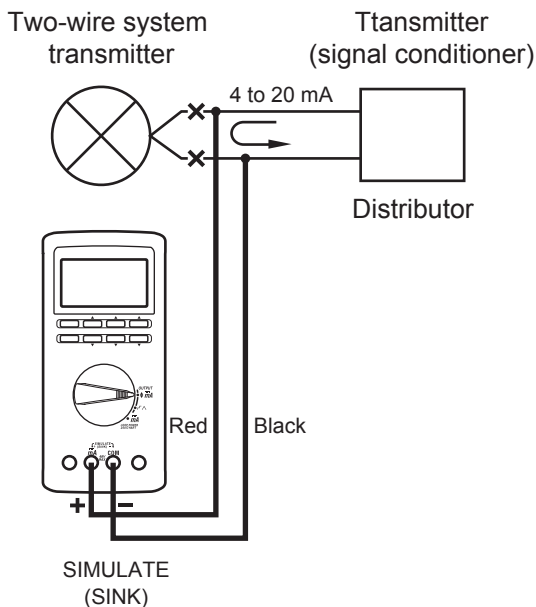

- 1) Turn the function switch to the “ $\blacklozenge \overline{mA}$ ” position.
After you turn the function switch, “OUTPUT” appears on the screen, and the output is set to 0% of the current span setting.
(If you turn the function switch from the “ $\ulcorner \wedge$ ” position to the “ $\blacklozenge \overline{mA}$ ” position, the output value setting and SOURCE/SIMULATE setting are retained.)
- 2) Press the SHIFT key. “SIMULATE” appears. (Current sinking starts.)
- 3) Connect the lead cables to the positive (+) and negative (-) SIMULATE terminals.
(Connect the positive SIMULATE terminal to the positive terminal of the external DCV power source. Make sure that the power source voltage is within 15 to 48 V.)
- 4) Just as in SOURCE mode, use the output setting keys to set the sink current value.
(To enter span check mode, hold down %STEP▲ or %STEP▼ for one second or longer.)
- 5) Connect the lead cables to the circuit under test.

Press the SHIFT key again. “SIMULATE” disappears, and the CA450 returns to constant current output (SOURCE) mode.

Tip

If the set current is 0.1 mA or more and the terminals are open, “-----” appears in the main display, and “-----” appears in the subdisplay.

4.4.3 Current Sweep Output

You can make the output current (in SOURCE or SIMULATE mode) automatically fluctuate between 0% and 100% of the current span setting.

- 1) Turn the function switch to the “ $\square\wedge$ ” position.
After you turn the function switch, “OUTPUT” appears on the screen, and the output starts rising from 0% of the current span setting.
(If you turn the function switch from the “ $\blacklozenge\overline{mA}$ ” position to the “ $\square\wedge$ ” position, the output value setting and SOURCE/SIMULATE setting are retained.)
- 2) Press the SHIFT key to select the current output mode (SOURCE or SIMULATE).
- 3) Press the SELECT key to select an output mode.
(When you change the output mode, the current starts rising from the value currently being output according to the new mode.)
- 4) After you connect the lead cables to the appropriate terminals for the output mode (SOURCE or SIMULATE), connect them to the circuit under test.

Tip

If you want to stop a current sweep that is being output, turn the function switch to “ $\blacklozenge\overline{mA}$.”
(The constant current output value is set to the value of the current being output when the switch is turned.)

Operation Mode	Operation
\wedge Slow	0% to 100% to 0% in 40 seconds
\wedge Fast	0% to 100% to 0% in 15 seconds
$\square\wedge$ Slow	0% to 100% to 0% in 25% steps Each step is 15 to 60 seconds long. *
$\square\wedge$ Fast	0% to 100% to 0% in 25% steps Each step is 5 seconds long.

^ Linear Mode Current Output

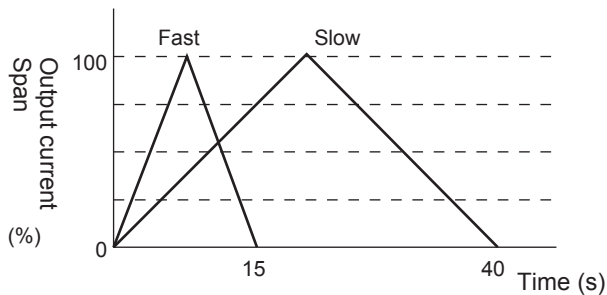

⌞ Step Mode Current Output

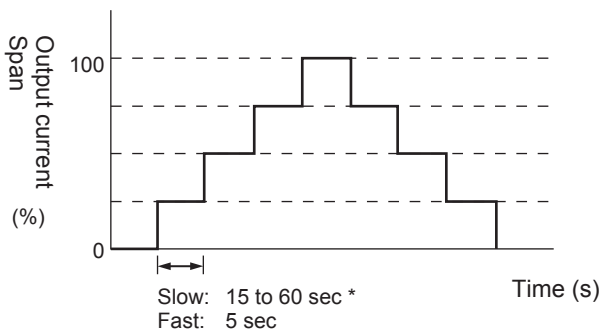

Tip

* In slow step mode, you can select 15, 30, 45, or 60 seconds.
See section 4.6.4, "Setting the Slow Step Time."

4.4.4 Current Span Setting

You can select one of the following two current spans.

The following two percentage displays vary depending on the selected range: the output current value and the measured current value for mA measurement mode in the 30 mA range.

Current Span Setting	Output Current and Measured Current (30 mA range)		Notes
	When the display is 0%	When the display is 100%	
4 to 20 mA	4.000 mA	20.000 mA	Factory default
0 to 20 mA	0.000 mA	20.000 mA	---

You can use the following method to set (change) the current span.

- 1) Turn the function switch to the "OFF" position, or put the CA450 into sleep mode.
- 2) While holding down the RANGE key, turn the function switch to any position.
If the CA450 is in sleep mode, hold down the RANGE and LIGHT keys for 2 seconds or longer.
- 3) After all the LCD elements appear and then disappear, release the key.
- 4) After setting the current span, turn the function switch to the "OFF" position, or put the CA450 into sleep mode.
If the current span was set to 4 to 20 mA, this operation changes it to 0 to 20 mA.
If the current span was set to 0 to 20 mA, this operation sets it to 4 to 20 mA.
The setting you make remains valid until you change it.

4.5 Auto Power-Off (Sleep) Function

When the Auto Power-Off Function Is Enabled

"AUTO OFF" appears.

- The CA450 has an auto power-off function that automatically switches itself to sleep mode 20 minutes after the last key operation.
The buzzer makes a beeping sound approximately 30 seconds before the CA450 enters sleep mode. (This period is referred to as the warning period.)
- If you press a key or switch during the warning period, the time before auto power-off is extended.
- You can clear sleep mode by turning the function switch to the OFF position, waiting 1 second or longer, and then turning the switch to any position other than OFF. (You can also hold down the LIGHT key for 2 seconds or longer to clear sleep mode.)

When the Auto Power-Off Function Is Disabled

- 1) Turn the function switch to the "OFF" position, or put the CA450 into sleep mode.
- 2) While holding down HOLD, turn the function switch to any position.
If the CA450 is in sleep mode, hold down the HOLD and LIGHT keys for 2 seconds or longer.

The auto power-off function is disabled, and "AUTO OFF" disappears.

Restoring the Auto Power-Off Function

When the function switch is set to OFF or when the CA450 enters sleep mode, the auto power-off function is restored.

(When the power is turned on or when sleep mode is cleared, "AUTO OFF" appears.)

4.6 Setup Function

You can use the setup function to:

1. Turn the buzzer on and off.
 2. Configure SENSOR mode input, display, and unit settings.
 3. Set the current range of the 100 mA range for DCmA measurement.
 4. Set the slow step time.
 5. Return the settings to their factory default values.
- 1) Press the SHIFT key. "Shift" appears on the display.
 - 2) While "Shift" is displayed, press the LIGHT key to switch to setup mode.
After "SETUP" appears, the screen for turning the buzzer on and off appears.

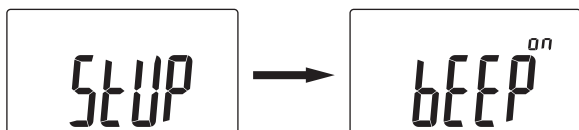

- 3) The setting to configure changes each time you press the LIGHT or SHIFT key.
- 4) To change a setting, use the ▲ (RANGE) and ▼ (REL) keys.
- 5) To save (confirm) a setting, press the HOLD key. ("SEt" appears, the setting is saved, and the setting item is redisplayed.)
- 6) To return to normal measurement from setup mode, hold down the LIGHT key for 1 second or longer.



Note

- To cancel a setting, press the LIGHT key for 1 second or longer without pressing the HOLD key, or use the function switch to turn the power off.
- You cannot enter setup mode from one of the current output modes (constant current output or current sweep output mode).

4.6.1 Turning the Buzzer On and Off

You can turn the buzzer (beeping) sound on and off.

Even if you turn the buzzer off, it will sound when it is performing important functions such as those listed below.

- Continuity check buzzer
- Excess input alarm buzzer
- Auto power-off warning buzzer

- 1) Press the LIGHT or SHIFT key to display "bEEP."
(Turn the buzzer on and off in the subdisplay. The initial setting is on.)

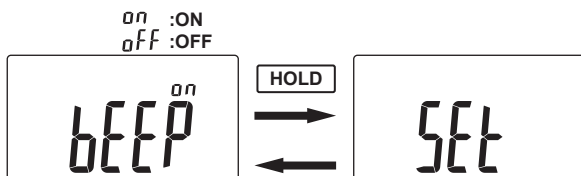

- 2) Use the ▲ (RANGE) and ▼ (REL) keys to select ON or OFF.
- 3) Press the HOLD key to save the setting.
(After "SEt" appears, "bEEP" will appear again.)
- 4) To return to normal measurement from setup mode, hold down the LIGHT key for 1 second or longer.

4.6.2 SENSOR Mode Input, Display, and Unit Settings

For SENSOR mode (mV position on the function switch), you can set the input voltage and the corresponding main display and unit for that input voltage.

- 1) Press the LIGHT or SHIFT key to display the screen shown below.
The parameter that can be changed blinks.

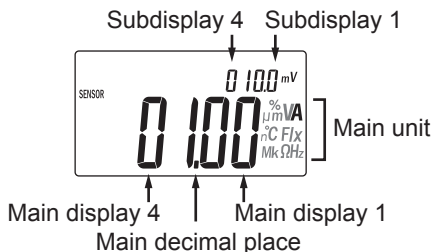

Keep pressing the LIGHT key to switch between the following parameters. Subdisplay 4, subdisplay 3, subdisplay 2, subdisplay 1, main display 4, main display 3, main display 2, main display 1, main decimal place, and main unit (You can press the SHIFT key to switch parameters in the opposite direction.)

- 2) Use the ▲ (RANGE) and ▼ (REL) keys to set the various values, the decimal place, and the unit.
- 3) Press the HOLD key to save the settings.
(After "SET" appears, the setting screen will appear again.)
- 4) To return to normal measurement from setup mode, hold down the LIGHT key for 1 second or longer.

<Settings>

Subdisplay value: 000.0 to 999.9

Main display value: 0000 to 9999

Main display decimal place: XXXX, X.XXX, XX.XX, or XXX.X

Main display unit: A, mA, μ A, $^{\circ}$ C, M Ω , k Ω , Ω , kHz, Hz, μ F, nF, %, lx, no unit, V, or mV

<Example>

For a current clamp sensor with an input-to-output ratio of 10 mV/A, set the subdisplay to 10.0 mV, and set the main display (value, decimal place, and unit) to 01.00 A.

With these settings, a maximum input of 660.0 mV will be displayed as 66.00 A.

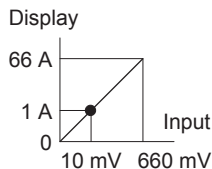

4.6.3 Current Span Setting for the 100 mA Range for DCmA Measurement

When you select the 100 mA range in DCmA measurement mode (\overline{mA}), you can change the current span (0 to 100 mA, 10 to 50 mA, or 0 to 50 mA).

Input Current Value (Main display)	Subdisplay for the 100 mA Range		
	0 to 100 mA	10 to 50 mA	0 to 50 mA
-110.00 mA	-110.0%	-300.0%	-220.0%
0.00 mA	0.0%	-25.0%	0.0%
10.00 mA	10.0%	0.0%	20.0%
50.00 mA	50.0%	100.0%	100.0%
100.00 mA	100.0%	225.0%	200.0%
110.00 mA	110.0%	250.0%	220.0%

- 1) Press the LIGHT or SHIFT key to display "SPAn."

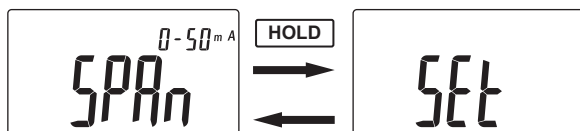

(The selected current span appears in the subdisplay.
The default span is 0 to 100 mA.)

- 2) Use ▲ (RANGE) and ▼ (REL) to select 0 to 100 mA, 10 to 50 mA, or 0 to 50 mA.
- 3) Press the HOLD key to save the setting.
(After "SEt" appears, "SPAn" will appear again.)
- 4) To return to normal measurement from setup mode, hold down the LIGHT key for 1 second or longer.

4.6.4 Setting the Slow Step Time

If you select slow step mode for current sweep output, you can select the hold time (in seconds) of each step.

- 1) Press the LIGHT or SHIFT key to display "t.Int."

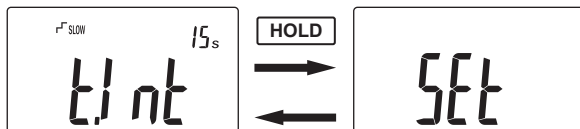

- 2) Use ▲ (RANGE) and ▼ (REL) to select 15s, 30s, 45s, or 60s.
- 3) Press the HOLD key to save the setting.
(After "SET" appears, "t.Int" will appear again.)
- 4) To return to normal measurement from setup mode, hold down the LIGHT key for 1 second or longer.

4.6.5 Returning the Settings to Their Factory Default Values

You can reset all the items that you have changed (set) in setup mode to their factory default values.

- 1) Press the LIGHT or SHIFT key to display the screen for initialization, which shows "dEF."

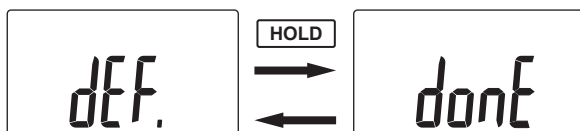

- 2) The settings return to their default values when you press the HOLD key.
(After "donE" appears, "dEF" will appear again.)
- 3) To return to normal measurement from setup mode, hold down the LIGHT key for 1 second or longer.

Initial Settings (Default Values) for the Setting Items

Setting Item		Initial Setting	
1.	Buzzer sound	ON	
2.	SENSOR mode	Subdisplay	10.0
		Main display	01.00
		Unit	A
3.	The current span of the 100 mA range for DCmA measurement	0 to 100 mA	
4.	Slow step time setting	15 sec	

4.7 Additional Power-on Functions

Hold one of the keys below, and turn the function switch from OFF to any position to configure various functions.

(If the CA450 is in sleep mode, hold down one of the keys below and the LIGHT key for 2 seconds or longer to configure various functions.)

Key	Configured Function	Details
RANGE	Current output and measurement (30 mA range) span (0 to 20 mA, 4 to 20 mA)	Section 4.4.4
SELECT	All the LCD elements appear (only while the SELECT key is pressed).	Section 4.7.1
HOLD	The auto power-off function is disabled.	Section 4.5
HOLD + REL Δ /%	The calibration data is returned to its factory default.	---
SELECT + RANGE	Calibration function	Chapter 5

4.7.1 Making All the LCD Elements Appear

If you hold down the SELECT key and turn the function switch from OFF to any position, all the LCD segments and marks are displayed.

The LCD segments and marks are only displayed while the SELECT key is held.

(If the CA450 is in sleep mode, hold down the SELECT and LIGHT keys for 2 seconds or longer to turn the entire LCD on.)

5. User Calibration Function

We recommend that you calibrate the instrument once a year to maintain its accuracy (high accuracy).

You can use the user calibration function to perform calibration.



CAUTION

To avoid electrical shock:

- Make sure that specialized technicians calibrate the instrument using the proper equipment.
 - To connect the CA450 to a signal generator (reference device), use the test leads and lead cables that come with the reference device.
 - Be sure to read the reference device's instruction manual before you calibrate the CA450.
 - When you switch measurement modes during calibration, be sure to remove the test leads and lead cables first, and then change the mode and terminal locations.
-
-

Calibration Conditions

Reference device: Use a reference device that fully satisfies the accuracy of the CA450.
DC voltage and current generator or digital multimeter (DMM)

Environment: Temperature: $23 \pm 5^{\circ}\text{C}$,
Humidity: 45 to 75% RH (no condensation)
Before you perform calibration, leave the CA450 in the environment described above for 30 minutes or more.

5.1 Calibrating Measurements

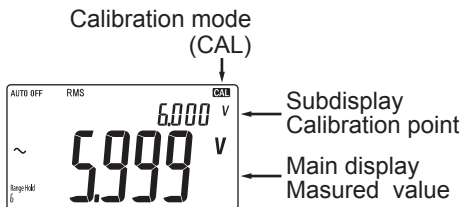

Perform calibration according to **Table 1**.

- 1) While holding down the SELECT and RANGE keys, turn the function switch from the OFF position to the ACV position.
The CA450 will start in “calibration mode.” (The “CAL” segment will be visible.)
If the CA450 is in sleep mode, hold down the SELECT, RANGE, and LIGHT keys for 2 seconds or longer to start the CA450 in calibration mode.
- 2) Use the test leads to connect the CA450 to the reference device.
- 3) From the reference device, apply the values in **Table 1**.
The calibration point appears in the subdisplay.
- 4) Press the Hz key to confirm the value.
Press the calibration confirmation key after the reference device’s value stabilizes.
- 5) To calibrate other ranges, press the RANGE key to switch the range, check the function switch and the input terminals, refer to **Table 1**, and perform steps 3) and 4) again.
To perform peak hold and loop power calibration, see section 5.1.1, “Peak Hold Calibration,” and section 5.1.2, “LOOP POWER calibration.”
- 6) To end calibration, turn the function switch off.



Note

You cannot calibrate the continuity check. Even in calibration mode, normal measurement is performed.
(Keys other than RANGE and SELECT cannot be used.)

Table 1 Calibration Table (Measurements)

Function	Range	Calibration Point (Input value)
AC voltage measurement \tilde{V}	6.000 V	6.000 V [50.00/60.00 Hz]
	60.00 V	60.00 V [50.00/60.00 Hz]
	600.0 V	600.0 V [50.00/60.00 Hz]
	1000 V	1000 V [50.00/60.00 Hz *1]
DC voltage measurement \bar{V}	6.000 V	6.000 V
	60.00 V	60.00 V
	600.0 V	600.0 V
	1000 V	1000 V
DC voltage measurement \bar{mV}	600 mV	600.0 mV
AC voltage measurement $\bar{mV}\tilde{V}$	600 mV	600.0 mV
Diode test $\rightarrow\leftarrow$	2 V	2.000 V
Resistance measurement Ω	600.0 Ω	600.0 Ω
	6.000 k Ω	6.000 k Ω
	60.00 k Ω	60.00 k Ω
	600.0 k Ω	600.0 k Ω
	6.000 M Ω	6.000 M Ω
	60.00 M Ω	40.00 M Ω
DC voltage measurement \bar{mA}	30.000 mADC	30.000 mA
	100.00 mADC	100.00 mA

*1 If the power supply frequency is 50 Hz, calibrate using 60.00 Hz.

If the power supply frequency is 60 Hz, calibrate using 50.00 Hz.

5.1.1 Peak Hold Calibration

- 1) In calibration mode (when the "CAL" segment is displayed), turn the function switch to the $\approx \nabla$ position.
- 2) Press the HOLD key to enable peak hold mode.
- 3) Use the test leads to connect the CA450 to the reference device.
- 4) From the reference device, apply the value under ZERO in **Table 2**.
The calibration point appears in the subdisplay.
You can clear the peak value by pressing the MIN/MAX key.
- 5) Press the Hz key to confirm the value.
- 6) From the reference device, apply the value under Full Scale in **Table 2**.
The calibration point appears in the subdisplay.
You can clear the peak value by pressing the MIN/MAX key.
- 7) Press the Hz key to confirm the value.
- 8) To end calibration, turn the function switch off.

Table 2 Calibration Table (Peak Hold)

Function	Range	Calibration Point (Input value)		Condition
		ZERO	+Full Scale	
DCV peak hold	6.000 V	0 V	6.000 V	---

5.1.2 Loop Power Calibration

- 1) In calibration mode (when the "CAL" segment is displayed), turn the function switch to the LOOP POWER position.
- 2) Connect the CA450 to the reference device as shown in the diagram.
- 3) Set the reference device (the sink) to -30.000 mA.
The calibration point appears in the subdisplay.
- 4) Adjust the reference device, which was set to -30.000 mA in the previous step, so that the DMM display value (measured value) is 3.0000 V.
- 5) Press the Hz key to confirm the value.
- 6) To end calibration, turn the function switch off.

Table 3 Calibration Table (Loop Power)

Function	Range	Calibration Point	DMM Display (Measured) Value
LOOP POWER	30.000 mA DC	30.000 mA	3.0000 V

Connection Diagram (Loop power)

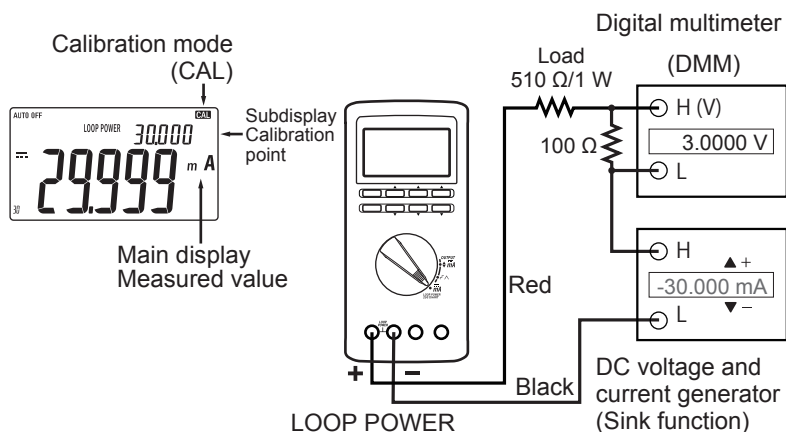

5.2 Calibrating Output

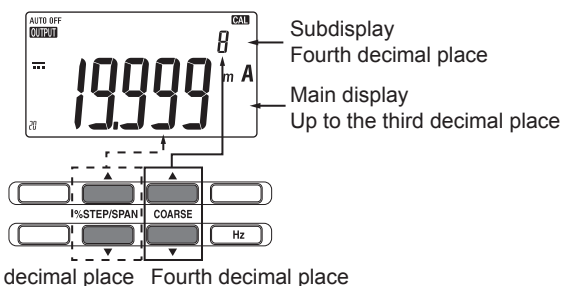

Perform calibration according to **Table 4**.

- 1) While holding down the SELECT and RANGE keys, turn the function switch from the OFF position to the \blacklozenge mA position. (The "CAL" segment will be visible.)
- 2) Connect the CA450 to the reference device as shown in the diagram.
- 3) Start +5% calibration:
In the main display and the subdisplay, 0.0000 mA appears.
(The display in the subdisplay shows the value up to the fourth decimal place.)

- 4) Use %STEP▲, %STEP▼, COARSE▲, and COARSE▼ to adjust the value that appears in the main display and the subdisplay so that it is the same as the value read by the multimeter connected to the CA450.
You can use %STEP▲ and %STEP▼ to adjust the second decimal place (values above the second decimal place are also affected), and you can use COARSE▲ and COARSE▼ to adjust the fourth decimal place (the third decimal place is also affected).
- 5) After you have finished adjusting the value, press the Hz key to confirm it.
- 6) Start full scale calibration:
In the main display and the subdisplay, 20.0000 mA appears.
(The display in the subdisplay shows the value up to the fourth decimal place.)
- 7) Use %STEP▲, %STEP▼, COARSE▲, and COARSE▼ to adjust the value that appears in the main display and the subdisplay so that it is the same as the value read by the multimeter connected to the CA450.
You can use %STEP▲ and %STEP▼ to adjust the second decimal place, and you can use COARSE▲ and COARSE▼ to adjust the fourth decimal place.
- 8) After you have finished adjusting the value, press the Hz key to confirm it.
The calibrated range value is computed and saved in the internal memory.
(The previous calibration data is overwritten.)
- 9) To stop calibration, turn the function switch off.
- 10) Perform steps 2) through 7) for the SOURCE and SIMULATE output modes.



Note

You cannot calibrate current sweep output. Even in calibration mode, normal output is performed.
(Keys other than SHIFT and SELECT cannot be used.)

Table 4 Calibration Table (Output)

Function	Output Direction	Calibration Point		Condition
		±5% *	±Full Scale	
Constant current output	SOURCE	1.0000 mA	20.0000 mA	---
	SIMULATE	1.0000 mA	20.0000 mA	28 V external voltage

* Adjust at 5% of the range.

Connection Diagram (SOURCE, SIMULATE)

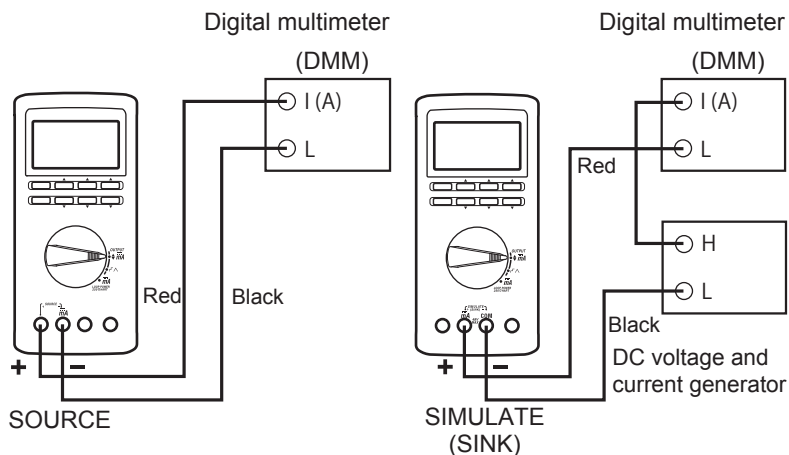

5.3 What to Check after Calibration

After you have finished calibrating the CA450, make sure (through inspection) that the calibration has been performed correctly and that the calibration values have been saved to the memory.

Inspection Method

After calibration has finished, turn off the CA450.

Then, turn on the CA450, and check the calibration in the normal output and measurement modes (not calibration mode).

Use the reference device that you used for calibration to check the calibration.

(Refer to the calibration points.)

6. Communication

You can configure the CA450 and check its settings, measured values, and other information from a PC.



Note

Through the use of a communication adapter, the CA450 can communicate with a PC through USB.

6.1 Cable Connection and Interface Specifications

Cable Connection

Model 92015: Communication Package (sold separately)
 (USB adapter, USB cable and software)

Remove the blank cover on the back of the CA450, and connect a USB adapter.

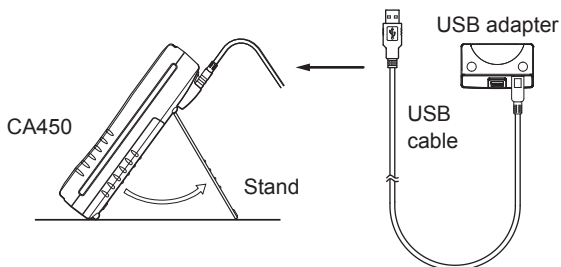

Configuring the RS232 Interface

Baudrate:	9600 bps
Parity:	None
Stop bits:	2 bits
Data length:	8 bits
Flow control:	None
Terminator:	CrLf only

6.2 Communication Commands

Item	Command	Description	Normal	Cal.
Data acquisition	OD	Outputs measured values	O	O
Measurement settings	MF	Queries the measurement function	O	X
	MR	Sets or queries the measurement range	O	O
	HD	Sets or queries the measured-value-display hold function	O	O
	SM	Sets or queries SENSOR mode	O	X
	DI	Switches or queries diode test mode	O	O
	IO	Sets or queries whether the internal resistor for HART communication is on or off	O	X
	MH	Sets or queries frequency measurement	O	X
	RP	Sets or queries the RELΔ/% display	O	X
	MI	Sets or queries the MIN/MAX/AVG function	O	X
	MC	Switches or queries the MIN/MAX/AVG function	O	X
	CC	Sets or queries whether the measurement mode is DCmV or ACmV (DC sensor or AC sensor in SENSOR mode)	O	O
RG	Sets or queries the auto range and range hold settings	O	X	
Output settings	SF	Queries the output function	O	X
	SR	Sets or queries the output range (span)	O	O
	SD	Sets or queries the output value	O	X
	AS	Sets or queries whether the current output function is set to SOURCE or SIMULATE mode	O	X
	UP	Increases the m th digit of the output value by 1	O	X
	DW	Decreases the m th digit of the output value by 1	O	X
	SP	Sets or queries SPAN check mode	O	X
	UQ	Increases the output value by one step or sets the output value to 100%	O	X
	DQ	Decreases the output value by one step or sets the output value to 0%	O	X
	RA	Sets or queries the current sweep output	O	O
SS	Sets or queries the slow step time	O	X	

Item	Command	Description	Normal	Cal.
Calibration	SY	Sets or queries whether the mode is normal mode or calibration mode	O	O
	CL	Queries the calibration item	X	O
	CP	Sets the calibration point	X	O
	CMF	Queries the measurement mode being calibrated	X	O
	CS	Confirms the measurement calibration value	X	O
	CSF	Queries the output mode being calibrated	X	O
	CR	Sets the output calibration value	X	O
	CD	Confirms the output calibration value	X	O
	CW	Saves the calibration value	X	O
Other commands	OE	Outputs error data	O	O
	OS	Outputs setup data	O	X
	ESC C/ RC	Initializes setup data	O	X
	ESC S	Outputs the status byte	O	O
	H	Sets or queries whether a header is attached to the output data (OD)	O	O
	IM	Sets or queries whether the bits in the status byte are detected or masked	O	O
	BL	Sets or queries whether the backlight is on or off	O	X
	HC	Resets the peak hold value	O	X
	BZ	Sets or queries whether the buzzer is on or off	O	X
	MP	Sets or queries the span setting for the 100 mA range for DCmA measurement	O	X
	SI	Sets or queries the input voltage value for SENSOR mode	O	X
	ST	Sets or queries the converted value for SENSOR mode	O	X
	SL	Sets or queries the decimal place for SENSOR mode	O	X
SU	Sets or queries the unit for SENSOR mode	O	X	

6.3 Detailed Command Descriptions

Configuration and Control

Command: The format for sending the command.

Answer: The format of replies to commands, such as configuration and control commands, that are not queries for information.
(Some commands do not receive any reply.)

When an error occurs, the same error message that appears on the LCD (“ERRm,” where m is the error number) is returned.

Queries

Command: The format for sending the command.

Return: The format of replies to commands that are queries for information.

Mode Conditions

Normal: The command can be used during normal measurement and output.

Cal.: The command can be used during user calibration (see chapter 5).

The other conditions for each command are listed in section 6.5, “Communication Command Validity Table.”

AS	Sets or queries whether the current output function is set to SOURCE or SIMULATE mode	Normal	Cal.
	Command = ASm<CRLF> -> Answer = ASm<CRLF> Command = AS?<CRLF> -> Return = ASm<CRLF> Parameters m = 0: SOURCE (default) 1: SIMULATE (SINK) This command returns ERR13 when the CA450 is in constant current output mode or current sweep output mode.	O	X

BL	Sets or queries whether the backlight is on or off	Normal	Cal.
	Command = BLm<CRLF> -> Answer = BLm<CRLF> Command = BL?<CRLF> -> Return = BLm<CRLF> Parameters m = 0: Off (default) 1: On	O	X

BZ	Sets or queries whether the buzzer is on or off	Normal	Cal.
	<p>Command = BZm<CRLF> -> Answer = BZm<CRLF> Command = BZ?<CRLF> -> Return = BZm<CRLF></p> <p>Parameters m = 0: OFF 1: On (default)</p>	O	X
CC	Sets or queries whether the measurement mode is DCmV or ACmV	Normal	Cal.
	<p>Command = CCm<CRLF> -> Answer = CCm<CRLF> Command = CC?<CRLF> -> Return = CCm<CRLF></p> <p>Parameters m = 0: DCmV measurement (default) 1: ACmV measurement</p> <p>In SENSOR mode m = 0: DC sensor measurement (default) 1: AC sensor measurement</p> <p>If the measurement mode is neither DCmV nor ACmV, ERR13 is returned.</p>	O	O
CD	Confirms the output calibration value	Normal	Cal.
	<p>Command = CD<CRLF> -> Answer = CD<CRLF></p> <p>In output calibration mode, the current output settings are used as the output calibration values for the currently selected function, range, and calibration point (+FS, +5%, -FS, or -5%). If the CA450 is in a measurement mode, ERR13 is returned.</p>	X	O
CL	Queries the calibration item	Normal	Cal.
	<p>Command = CL?<CRLF> -> Return = CLm<CRLF></p> <p>Parameters m = 3: Output calibration 4: Measurement calibration</p>	X	O

CMF	Queries the measurement mode being calibrated	Normal	Cal.
	<p>Command = CMF?<CRLF> -> Return = CMFm<CRLF></p> <p>Parameters</p> <ul style="list-style-type: none"> m = 0: DCV 2: Ω 5: Hz 7: ACV 8: DCmV 9: ACmV 10: Diode test 11: Continuity check 12: DCmA 13: LOOP POWER <p>If the CA450 is in constant current output, current sweep output, or continuity check function, ERR13 is returned.</p>	X	O

CP	Sets the calibration point	Normal	Cal.
	<p>Command = CPm<CRLF> -> Answer = CPm<CRLF></p> <p>Parameters</p> <ul style="list-style-type: none"> m = 0: +FS calibration 1: Peak hold zero calibration or +5% output calibration 2: -FS calibration 3: -5% calibration <p>-FS calibration and -5% calibration are used to calibrate the SIMULATE output mode.</p> <p>If -FS calibration or -5% calibration is specified in measurement mode, ERR13 is returned.</p>	X	O

CR	Sets the output calibration value	Normal	Cal.
	Command = CRm<CRLF> -> Answer = CRm<CRLF> Command = CR?<CRLF> -> Return = CRm<CRLF> Parameters m = 18.0000 to 22.0000 for \pm FS calibration m = 0.9600 to 1.0400 for \pm 5% calibration	X	O
CS	Confirms the measurement calibration value	Normal	Cal.
	Command = CS<CRLF> -> Answer = CS<CRLF> In measurement calibration mode, the current measured values are used as the measurement calibration values for the currently selected function, range, and calibration point (+FS or +0). If the CA450 is in an output mode, ERR13 is returned.	X	O
CSF	Queries the output mode being calibrated	Normal	Cal.
	Command = CSF?<CRLF> -> Return = CSFm<CRLF> Parameters m = 14: Constant current output m = 15: Current sweep output If the CA450 is in a measurement mode, ERR13 is returned.	X	O
CW	Saves the calibration value	Normal	Cal.
	Command = CW<CRLF> -> Answer = CW,OK<CRLF> (normal completion) Saves the data after a mode or range is calibrated. If you turn off the CA450 without executing this command, the calibrations made immediately before are discarded.	X	O

DI	Switches or queries diode test mode	Normal	Cal.
	<p>Command = DIM<CRLF> -> Answer = DIM<CRLF> Command = DI?<CRLF> -> Return = DIM<CRLF></p> <p>Parameters m = 0: Resistance measurement (default) 1: Diode test</p> <p>If the mode is neither Ω nor diode test, ERR13 is returned.</p>	O	O
DQ	Decreases the output value by one step or sets the output value to 0%	Normal	Cal.
	<p>Command = DQ<CRLF> -> Answer = DQ,OK<CRLF></p> <p>Decreases the output value by one step (25%). Sets the output value to 0% of the span in span check mode. If the CA450 is in any mode other than constant current output mode, ERR13 is returned.</p>	O	X
DW	Decreases the m th digit of the output value by 1	Normal	Cal.
	<p>Command = DWm<CRLF> -> Answer = DW,OK<CRLF></p> <p>Parameters m = 1 to 5 (1 is the least significant digit while 5 is the most significant digit)</p> <p>If the CA450 is in any function other than constant current output function, ERR13 is returned. If the CA450 is in span check mode, ERR13 is returned.</p>	O	X

ESC C/ RC	Initializes setup data ("ESC" = ASCII 0x1B)	Normal	Cal.
	Command = ESC C<CRLF> or Command = RC<CRLF> However, when this command is used to initialize the settings: The output current span setting (0 to 20 mA or 4 to 20 mA) is not initialized.	O	X
ESC S	Outputs the status byte ("ESC" = ASCII 0x1B)	Normal	Cal.
	Command = ESC S<CRLF> -> Answer = m<CRLF> Outputs the status byte (as a decimal number). See section 6.6, "Status Byte Format."	O	O
H	Sets or queries whether a header is attached to the output data (OD)	Normal	Cal.
	Command = Hm<CRLF> -> Answer = Hm<CRLF> Command = H?<CRLF> -> Return = Hm<CRLF> Parameters m = 0: Header is not attached. (default) 1: Header is attached. The changed setting is valid until the power is turned off.	O	O
HC	Resets the peak hold value	Normal	Cal.
	Command = HC<CRLF> -> Answer = HC,OK<CRLF> When peak hold is not enabled, ERR13 is returned.	O	X

HD	Sets or queries the measured-value-display hold function	Normal	Cal.
	<p>Command = HDm<CRLF> -> Answer = HDm<CRLF> Command = HD?<CRLF> -> Return = HDm<CRLF></p> <p>Parameters</p> <p>m = 0: Display update enabled (default) 1: Data hold 2: Auto hold 3: Peak hold</p> <ul style="list-style-type: none"> • If the CA450 is in an output mode, ERR13 is returned. • During MIN/MAX measurement, if HD1 is sent, recording and the updating of the display of the elapsed time are stopped. If HD0 is sent, recording and the updating of the display of the elapsed time are resumed. • If HD1 is sent while peak hold is enabled, ERR13 is returned. • To clear peak hold, use the HC command. 	0	0*

* During calibration, only the HD3 command, which switches the mode so that peak hold calibration can be performed, is valid.

IM	<p>Sets or queries whether the bits in the status byte are detected or masked</p> <p>Command = IMm<CRLF> -> Answer = IMm<CRLF> Command = IM?<CRLF> -> Return = IMm<CRLF></p> <p>Sets whether each of the bits in the status byte is detected or masked. (Querying is performed using the ESC S command. See section 6.6.) If you specify IM0, all the bits are masked. If you specify IM63, all the data bits reflect the current status.</p> <p>Parameter m = 0 to 63</p> <ul style="list-style-type: none"> 1: bit0 (measurement completion) is detected 2: bit1 (output adjustment completion) is detected 4: bit2 (syntax error) is detected 8: bit3 (overrange) is detected 16: bit4 (24 V loop output error) is detected 32: bit5 (output error) is detected <p>(Bits 6 and 7 of the status byte are fixed bits.)</p> <p>The default is m = 63 (no masking)</p>	Normal	Cal.
IO	<p>Sets or queries whether the internal resistor for HART communication is on or off</p> <p>Command = IOm<CRLF> -> Answer = IOm<CRLF> Command = IO?<CRLF> -> Return = IOm<CRLF></p> <p>Parameters m = 0: 250 Ω resistor off (default) 1: 250 Ω resistor on</p> <p>If the CA450 is in any mode other than loop power measurement mode, ERR13 is returned.</p>	Normal	Cal.

MC	Switches or queries the MIN/MAX/AVG function	Normal	Cal.
	Command = MCm<CRLF> -> Answer = MCm<CRLF> Command = MC?<CRLF> -> Return = MCm<CRLF> Parameters m = 0: Measured value display (default) 1: MAX value display 2: MIN value display 3: AVG value display If MIN/MAX/AVG recording is disabled, ERR13 is returned.	O	X

MF	Queries the measurement function	Normal	Cal.
	Command = MF?<CRLF> -> Return = MFm<CRLF> Parameters m = 0: DCV 2: Ω 5: Hz 7: ACV 8: DCmV 9: ACmV 10: Diode test 11: Continuity check 12: DCmA 13: LOOP POWER	O	X

MH	Switches or queries frequency measurement	Normal	Cal.
	Command = MHm<CRLF> -> Answer = MHm<CRLF> Command = MH?<CRLF> -> Return = MHm<CRLF> Parameters m = 0: ACV measurement (default) 1: Frequency measurement If the CA450 is in any mode other than ACV mode, ERR13 is returned.	O	X

MI	<p>Sets or queries the MIN/MAX/AVG function</p> <p>Command = MIm<CRLF> -> Answer = MIm<CRLF> Command = MI?<CRLF> -> Return = MIm<CRLF></p> <p>Parameters</p> <p>m = 0: MIN/MAX/AVG recording is disabled (default) 1: MIN/MAX/AVG recording starts</p> <p>If the CA450 is in an output mode, ERR13 is returned.</p>	Normal	Cal.
MP	<p>Sets or queries the span setting for the 100 mA range for DCmA measurement</p> <p>Command = MPm<CRLF> -> Answer = MPm<CRLF> Command = MP?<CRLF> -> Return = MPm<CRLF></p> <p>Parameters</p> <p>m = 0: 0 to 100 mA (default) 1: 10 to 50 mA 2: 0 to 50 mA</p> <p>If the CA450 is in an output mode, ERR13 is returned. The changed setting is valid until it is changed again.</p>	Normal	Cal.

MR	Sets or queries the measurement range	Normal	Cal.
	Command = MRm<CRLF> -> Answer = MRm<CRLF>	O	O
	Command = MR?<CRLF> -> Return = MRm<CRLF>		
	Parameters		
	[DCV] m = 1: 6 V 3: 60 V 4: 600 V 5: 1000 V		
	[DCA] m = 0: 30 mA 1: 100 mA		
	[ACV] m = 0: 6 V 1: 60 V 2: 600 V 3: 1000 V		
	[Ω] m = 0: 600 Ω 1: 6 kΩ 2: 60 kΩ 3: 600 kΩ 4: 6 MΩ 5: 60 MΩ		
	[DCmV] m = 0: 600 mV		
	[ACmV] m = 0: 600 mV		
	[Diode test] m = 0: 2 V		
	[Continuity check] m = 0: 600 Ω		
	[LOOP POWER] m = 0: 30 mA		

OD	Outputs measured values	Normal	Cal.
	<p>Command = OD<CRLF> -> Return = abbcstddddddeee<CRLF></p> <p>Parameters</p> <p>Header (4 bytes)*</p> <p>a = V: voltage, A: current, O: resistance, T: temperature, F: frequency, S: SENSOR mode</p> <p>bb = DC: direct current, AC: alternating current, R3: resistance measurement</p> <p>c = N: normal, O: overrange, E: no data, B: burnout</p> <p>* The header will not appear if you specify 0 (no header) in the H command.</p> <p>Data Area (10 bytes)</p> <p>s (sign) = _: plus or -: minus (_ represents a space)</p> <p>dddddd = measured value (6 digits)</p> <p>eee = E+0, E+3, E-3, E+6, E-6</p> <p>(For overrange, no data, and burnout, dddddeee = _99999.E+6)</p>	O	O
OE	Outputs error data	Normal	Cal.
	<p>Command = OE<CRLF> -> Return = ERRm<CRLF></p> <p>Outputs the most recent output error.</p> <p>After a value is returned, the saved error number is overwritten with 'ERR00<CRLF>'.</p> <p>Even if there is no error, 'ERR00<CRLF>' is returned.</p> <p>Parameters</p> <p>m = Error code</p> <p>See section 6.4, "List of Errors."</p>	O	O

OS	Outputs setup data	Normal	Cal.
	<p>Command = OS<CRLF> -> Return = Measure a<CRLF> Function b<CRLF> Range c<CRLF> Source d<CRLF> Function e<CRLF> Range f<CRLF> Data g<CRLF> 24V Output h<CRLF> Light i<CRLF> Charge j<CRLF></p> <p>Parameters</p> <p>a (measurement) = ON or OFF</p> <p>b (measurement function) = DCV, OHM, FREQ, ACV, DCmV, ACmV, DIODE, CONTINUITY, DCmA, LOOP POWER</p> <p>c (measurement range) = 1000V, 600V, 60V, 6V for DCV/FREQ 600 mV for DCmV 600 mV for ACmV 60 MOHM, 6MOHM, 600kOHM, 60kOHM, 6kOHM, 600OHM for OHM 2 V for diode test 600OHM for continuity check 100 mA or 30 mA for DCmA 30 mA for loop power</p> <p>d (output) = ON or OFF</p> <p>e (output function) = DCmA</p> <p>f (output range) = 20 mA for DCmA</p> <p>g (output value)</p> <p>h (output for 24 V loop measurement) = ON or OFF</p> <p>i (backlight) = ON or OFF</p> <p>j (charging) = OFF (always OFF)</p>	O	X

RA	<p>Sets or queries the current sweep output</p> <p>Command = RAm<CRLF> -> Answer = RAm<CRLF> Command = RA?<CRLF> -> Return = RAm<CRLF></p> <p>Parameters</p> <p>m = 0: Slow Linear (default) 1: Fast Linear 2: Slow Step 3: Fast Step</p> <p>When the CA450 is in a measurement mode or constant current output mode, ERR13 is returned.</p>	Normal O	Cal. O
RG	<p>Sets or queries the auto range and range hold settings</p> <p>Command = RGm<CRLF> -> Answer = RGm<CRLF> Command = RG?<CRLF> -> Return = RGm<CRLF></p> <p>Parameters</p> <p>m = 0: Auto range (default) 1: Range hold</p> <p>When the CA450 is in an output mode or DCmV, ACmV, diode test, or continuity check mode, ERR13 is returned.</p>	Normal O	Cal. X
RP	<p>Sets or queries the RELΔ/% display</p> <p>Command = RPm<CRLF> -> Answer = RPm<CRLF> Command = RP?<CRLF> -> Return = RPm<CRLF></p> <p>Parameters</p> <p>m = 0: Normal measurement (default) 1: RELΔ display 2: REL% display</p> <p>If the CA450 is in an output mode, ERR13 is returned.</p>	Normal O	Cal. X

SD	Sets or queries the output value	Normal	Cal.
	<p>Command = SDm<CRLF> -> Answer = SDm<CRLF> Command = SD?<CRLF> -> Return = SDm<CRLF></p> <p>Parameters m (output value) = 0.000 to 25.000</p> <p>If the CA450 is in a measurement mode, ERR13 is returned.</p>	O	X
SF	Queries the output function	Normal	Cal.
	<p>Command = SF?<CRLF> -> Return = SFm<CRLF></p> <p>Parameters m = 14: Constant current output 15: Current sweep output</p> <p>If the CA450 is in a measurement mode, ERR13 is returned.</p>	O	X
SI	Sets or queries the input voltage value for SENSOR mode	Normal	Cal.
	<p>Command = SIm<CRLF> -> Answer = SIm<CRLF> Command = SI?<CRLF> -> Return = SIm<CRLF></p> <p>Parameters m (input voltage value) = 0000 to 9999 (4 digits)</p> <p>If the CA450 is in an output mode, ERR13 is returned. Because the decimal place of the input voltage value is fixed, only the number is entered.</p>	O	X
SL	Sets or queries the decimal place for SENSOR mode	Normal	Cal.
	<p>Command = SLm<CRLF> -> Answer = SLm<CRLF> Command = SL?<CRLF> -> Return = SLm<CRLF></p> <p>Parameters m (decimal place) = 0: X.XXX, 1: XX.XX, 2: XXX.X, 3: XXXX</p> <p>If the CA450 is in an output mode, ERR13 is returned.</p>	O	X

SM	Sets or queries SENSOR mode	Normal	Cal.
	<p>Command = SMm<CRLF> -> Answer = SMm<CRLF> Command = SM?<CRLF> -> Return = SMm<CRLF></p> <p>Parameters m = 0: SENSOR mode is disabled (default) 1: SENSOR mode is enabled</p> <p>If the CA450 is in a mode other than DCmV or DCmA mode, ERR13 is returned.</p>	O	X
SP	Sets or queries SPAN check mode	Normal	Cal.
	<p>Command = SPm<CRLF> -> Answer = SPm<CRLF> Command = SP?<CRLF> -> Return = SPm<CRLF></p> <p>Parameters m = 0: SPAN check mode is disabled (default) 1: SPAN check mode is enabled</p> <p>When you switch to span check mode, the previously output values are retained. Change the output values using commands such as the UQ and DQ commands. If the CA450 is in any mode other than constant current output mode, ERR13 is returned.</p>	O	X
SR	Sets or queries the output range (span)	Normal	Cal.
	<p>Command = SRm<CRLF> -> Answer = SRm<CRLF> Command = SR?<CRLF> -> Return = SRm<CRLF></p> <p>Parameters m = 0: 4 to 20 mA span (factory default setting) 1: 0 to 20 mA span</p> <p>The changed setting is valid until it is changed again.</p>	O	O

SS	Sets or queries the slow step time	Normal	Cal.
	<p>Command = SSm<CRLF> -> Answer = SSm<CRLF> Command = SS?<CRLF> -> Return = SSm<CRLF></p> <p>Parameters m = 0: 15 seconds (default) 1: 30 seconds 2: 45 seconds 3: 60 seconds</p> <p>If you select slow step mode for current sweep output, this command sets or queries the hold time of each step. If the CA450 is in an output mode, ERR13 is returned.</p>	O	X
ST	Sets or queries the converted value for SENSOR mode	Normal	Cal.
	<p>Command = STm<CRLF> -> Answer = STm<CRLF> Command = ST?<CRLF> -> Return = STm<CRLF></p> <p>Parameters m (converted value) = 0000 to 9999 (4 digits)</p> <p>If the CA450 is in an output mode, ERR13 is returned.</p>	O	X
SU	Sets or queries the unit for SENSOR mode	Normal	Cal.
	<p>Command = SUm<CRLF> -> Answer = SUm<CRLF> Command = SU?<CRLF> -> Return = SUm<CRLF></p> <p>Parameters m (unit) = 0: A, 1: mA, 2: uA, 3: °C, 5: MΩ, 6: kΩ, 7: Ω, 8: kHz, 9: Hz, 10: uF, 11: nF, 12: % 13: lx, 14: none, 15: V, 16: mV</p> <p>If the CA450 is in an output mode, ERR13 is returned.</p>	O	X

SY	Sets or queries whether the mode is normal mode or calibration mode	Normal	Cal.
	Command = SYm<CRLF> -> Answer = SYm<CRLF> Command = SY?<CRLF> -> Return = SYm<CRLF> Parameters m = 0: Normal mode (default) 1: Calibration mode	O	O

UP	Increases the m th digit of the output value by 1	Normal	Cal.
	Command = UPm<CRLF> -> Answer = UP,OK<CRLF> Parameters m = 1 to 5 (1 is the least significant digit while 5 is the most significant digit) If the CA450 is in any mode other than constant current output mode, ERR13 is returned. If the CA450 is in span check mode, ERR13 is returned.	O	X

UQ	Increases the output value by one step or sets the output value to 100%	Normal	Cal.
	Command = UQ<CRLF> -> Answer = UQ,OK<CRLF> Increases the output value by one step (25%). Sets the output value to 100% of the span in span check mode. If the CA450 is in any mode other than constant current output mode, ERR13 is returned.	O	X

6.4 List of Errors

Number	Description
ERR00	No errors
ERR11	An undefined command has been received.
ERR12	The parameter specification for the command is incorrect.
ERR13	A command has been received that cannot be executed because of the status of the CA450.
ERR16	An error was detected during calibration.
ERR20	Error in the power supply for LOOP POWER measurement
ERR23	The output current or voltage has exceeded its limit.
ERR60	The saved setting data in the internal flash memory is not correct.
ERR61	The saved measurement calibration value data in the internal flash memory is not correct.
ERR62	The saved output calibration value data in the internal flash memory is not correct.

If error number 11, 12, or 13 occurs during communication, the error number appears in the LCD main display.

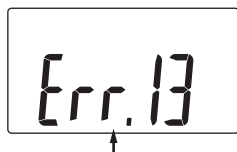

When ERR13 appears in the main display

6.5 Communication Command Validity Table

Command	Measurement					Output			
	Normal	RELA/%	MIN/ MAX	Cal.	SETUP	Constant		Current Sweep	
						Current	Output	Output	Output
						Normal	Cal.	Normal	Cal.
AS	X	X	X	X	X	O	X	O	O
BL	O	O	O	X	O	O	X	O	X
BZ	O	O	O	X	X	O	X	O	X
CC	O	O	X	O	X	X	X	X	X
CD	X	X	X	X	X	X	O	X	X
CL	X	X	X	O	X	X	O	X	X
CMF	X	X	X	O	X	X	X	X	X
CP	X	X	X	O	X	X	O	X	X
CS	X	X	X	O	X	X	X	X	X
CSF	X	X	X	X	X	X	O	X	X
CR	X	X	X	X	X	X	O	X	X
CW	X	X	X	O	X	X	O	X	X
DQ	X	X	X	X	X	O	X	X	X
DI	O	O	X	O	X	X	X	X	X
DW	X	X	X	X	X	O	X	X	X
ESC C/ RS	O	O	O	X	X	O	X	O	X
ESC S	O	O	O	O	O	O	O	O	O
H	O	O	O	O	O	O	O	O	O
HC	O	O	X	X	X	X	X	X	X
HD	O	O	O	O	X	X	X	X	X
IM	O	O	O	O	O	O	O	O	O
IO	O	X	X	O	X	X	X	X	X
MC	X	X	O	X	X	X	X	X	X
MF	O	O	O	X	X	X	X	X	X
MH	O	O	X	X	X	X	X	X	X
MI	O	X	O	X	X	X	X	X	X
MP	O	O	O	X	X	X	X	X	X
MR	O	X	X	O	X	X	X	X	X

Command	Measurement					Output			
	Normal	RELA/%	MIN/ MAX	Cal.	SETUP	Constant Current Output		Current Sweep Output	
						Normal	Cal.	Normal	Cal.
OD	O	O	O	O	O	X	X	X	X
OE	O	O	O	O	O	O	O	O	O
OS	O	O	O	X	O	O	X	O	X
RA	X	X	X	X	X	X	X	O	O
RG	O	X	X	X	X	X	X	X	X
RP	O	O	X	X	X	X	X	X	X
SD	X	X	X	X	X	O	X	X	X
SF	X	X	X	X	X	O	X	O	X
SI	O	O	O	X	X	X	X	X	X
SL	O	O	O	X	X	X	X	X	X
SM	O	X	X	X	X	X	X	X	X
SP	X	X	X	X	X	O	X	X	X
SR	O	O	O	O	X	O	O	O	O
SS	O	O	O	X	X	X	X	X	X
ST	O	O	O	X	X	X	X	X	X
SU	O	O	O	X	X	X	X	X	X
SY	O	X	X	O	X	O	O	O	O
UP	X	X	X	X	X	O	X	X	X
UQ	X	X	X	X	X	O	X	X	X

There are communication commands that may not be executable depending on the selected mode and the status of the CA450.

6.6 Status Byte Format

Status byte format (see the explanation of the ESC S command)

bit 7	bit 6	bit 5	bit 4	bit 3	bit 2	bit 1	bit 0
0 (fixed)	1 (fixed)	Output error	LOOP POWER supply error	Overrange	Syntax error	Output adjustment completion	Measurement end

bit 7	Fixed at 0
bit 6	Fixed at 1
bit 5	Becomes 1 if an error occurs during output. The data is held until the status byte is read.
bit 4	Becomes 1 if an error occurs in the power supply for LOOP POWER measurement. The data is held until the status byte is read.
bit 3	Becomes 1 if a measured value is outside of its limits (overrange). Becomes 1 if the CA450 switches to a higher range when auto range is enabled. The data is held until the status byte is read.
bit 2	Becomes 1 when a forbidden operation or command is processed, when the CA450 cannot parse a command, or when a parameter is outside of its range. The data is held until the status byte is read.
bit 1	Becomes 1 when output is on after the output value has changed and the output has stabilized. The data is held until the status byte is read.
bit 0	Becomes 1 when measured data is confirmed during measurement. The data is held until the status byte is read.

7. Replacing the Batteries and Fuses

7.1 Replacing the Batteries

When the battery voltage falls below the operating voltage,  appears on the display. Follow the procedure below to replace the batteries.

WARNING

-
-
- To avoid electrical shock, be sure to disconnect the CA450 from the circuit under measurement. (Remove the test leads and lead cables as well.)
 - Turn the CA450 off.
 - Do not measure while the case is open. Doing so may lead to electric shock.
-
-

CAUTION

-
-
- Do not mix different types of batteries or mix old batteries with new batteries.
 - Insert the batteries with their polarities in the directions indicated by the holder.
-
-

Replacement Procedure

- 1) Remove the fastening screw on the back of the CA450's case.
- 2) Open the case.
- 3) Replace each of the four batteries with a new battery.
- 4) Return the case to its original position, and tighten the fastening screw.

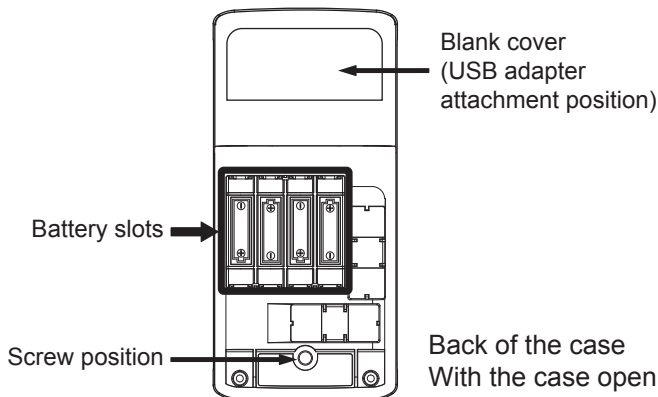

7.2 Replacing the Fuses

During current range measurement, the fuses may melt (blow out) because of excessive current. If this happens, replace the fuses.

WARNING

- To avoid electrical shock, be sure to disconnect the CA450 from the circuit under measurement. (Remove the test leads and lead cables as well.)
- Turn the CA450 off.
- Do not measure while the case is open. Doing so may lead to electric shock.
- To avoid damaging the CA450, be sure to use the specified fuses.

Fuse specifications (rating, maker, and model number):

F1 and F2

(440 mA/1000 V, Littlefuse, FLU .440)

Model number: 99042

Replacement Procedure

- 1) Remove the fastening screw on the back of the CA450's case.
- 2) Open the case.
- 3) Remove the fuses from their holders.
- 4) Insert the new fuses into the holders. (Check the ratings of the fuses.)
- 5) Return the case to its original position, and tighten the fastening screw.

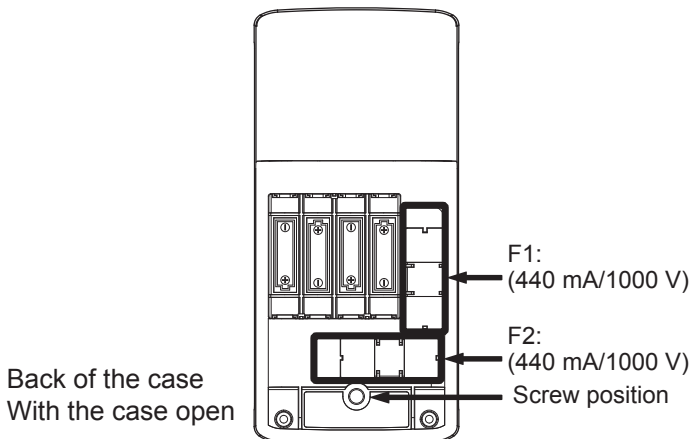

8. Calibration and After-Sales Service

Please direct questions about this product to the contact your nearest YOKOGAWA dealer.

Calibration

We recommend that you calibrate the instrument once a year to maintain its accuracy (high accuracy).

Recommended calibration period: 1 year

(Refer to the information about the user calibration function.)

For a service of calibration, contact your nearest YOKOGAWA dealer.

Serial Number

Serial number can be found on back-side of this product.

Serial number details

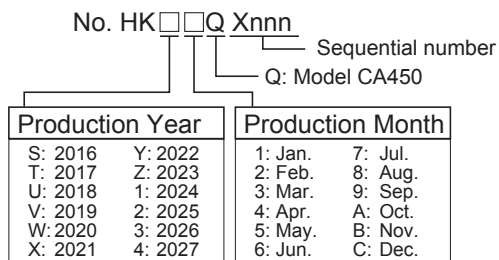

Rear (Back)

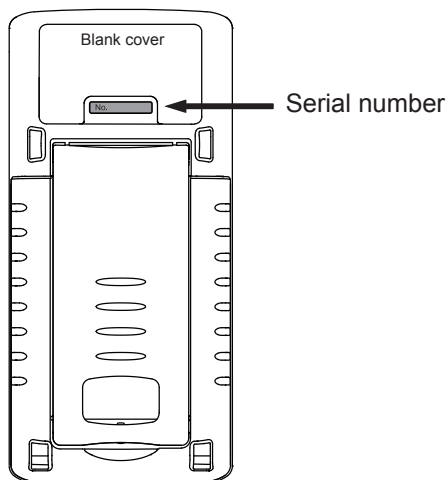

9. Troubleshooting

What to Check When There Is a Problem

If the CA450 does not work properly even after you check the items below or you have a problem that is not listed below, contact your nearest YOKOGAWA dealer.

Symptom	Items to Check
Even when the power is on, nothing appears on the LCD.	<ul style="list-style-type: none">• Are the batteries inserted properly?• Have the batteries worn out?
Current output is not working.	<ul style="list-style-type: none">• Have the fuses melted (blow out)? <p>SOURCE mode:</p> <ul style="list-style-type: none">• When the current is output, is the load resistance too high? (Open output terminals or leads) <p>SIMULATE mode:</p> <ul style="list-style-type: none">• Is the input voltage too low? (Check the external DCV power supply.)
The output or measured values are strange.	<ul style="list-style-type: none">• Is it possible that the values are being affected by noise?
Control through the USB interface is not working.	<ul style="list-style-type: none">• Are the communication settings correct?
"Err60" appears when the power is turned on.	<ul style="list-style-type: none">• The settings that were specified with the setup function are incorrect. Refer to section 4.6, "Setup Function," to return the CA450 to its factory default settings.
"Err61" or "Err62" appears when the power is turned on.	<ul style="list-style-type: none">• The calibration data is incorrect. Refer to section 4.7, "Additional Power-on Functions," to return the calibration data to its factory defaults. <p>If after you perform the above operations, errors still appear every time you turn on the power, repairs are necessary.</p>

10. Sales in Each Country or Region

10.1 Disposing the Product

Waste Electrical and Electronic Equipment (WEEE), Directive

(This directive is valid only in the EU.)



This product complies with the WEEE directive marking requirement. This marking indicates that you must not discard this electrical/electronic product in domestic household waste.

Product Category

With reference to the equipment types in the WEEE directive, this product is classified as a "Monitoring and control instruments" product.

When disposing products in the EU, contact your local Yokogawa Europe B.V. office.

Do not dispose in domestic household waste.

10.2 How to Replace and Dispose the Batteries

EU Battery Directive

(This directive is valid only in the EU.)

Batteries are included in this product.

When you remove batteries from this product and dispose them, discard them in accordance with domestic law concerning disposal.

Take a right action on waste batteries, because the collection system in the EU on waste batteries are regulated.



Battery type: Alkaline dry cell

Notice:

This marking indicates they shall be sorted out and collected as ordained in the EU battery directive.

How to remove batteries safely:

For further details, see section 7.1 "Replacing the Batteries."

10.3 Authorized Representative in the EEA

Yokogawa Europe B.V. is the authorized representative of Yokogawa Test & Measurement Corporation for this product in the EEA. (EEA: European Economic Area)

To contact Yokogawa Europe B.V., see the separate list of worldwide contacts, PIM 113-01Z2.

10.4 For the Pollution Control of Electronic and Electrical Products of the People's Republic of China

They are applicable only in China.

产品中有害物质的名称及含量

部件名称	有害物质					
	铅 (Pb)	汞 (Hg)	镉 (Cd)	六价铬 (Cr(VI))	多溴联苯 (PBB)	多溴二苯醚 (PBDE)
框架(塑料)	×	○	○	○	○	○
线路板 ASSY	×	○	○	○	○	○
导线 98073 98064	×	○	○	○	○	○
电池	×	○	○	○	○	○
< 选购 >						
导线 98073 98064	×	○	○	○	○	○

○：表示该有害物质在该部件所有均质材料中的含量均在 GB/T 26572 规定的限量要求以下。

×：表示该有害物质至少在该部件的某一均质材料中的含量超出 GB/T 26572 规定的限量要求。

环保使用期限：该标识适用于 SJ/T 11364 中所述，在中华人民共和国销售的电子电气产品的环保使用期限。

只要您遵守该产品相关的安全及使用注意事项，在自制造日起算的年限内，则不会因产品中有有害物质泄漏或突发变异，而造成对环境的污染或对人体及财产产生恶劣影响。



注)

该年数为“环保使用期限”，并非产品的质量保质期。零件更换的推荐周期，请参照使用说明书。

Appendix (External Dimensions)

