

PD9000 ConsoliDator+ Multivariable Controller

Instruction Manual



 **ConsoliDator+**



UL & C-UL Listed for Div 2
Hazardous (nonincendive) and
Ordinary Location Installations.
Select models; see Ordering
Information for complete details.

- NEMA 4X Panel Mount Multivariable Controller
- Convenient Display, Control, & Alarm of Multiple 4-20 mA, Temperature, Pulse, & Modbus Inputs
- Numeric & Bargraph Color Display (320 x 240 pixels) 5.7" (145 mm)
- Sunlight Readable Display, White Backlight; UL/C-UL Listed Sun Hood Option Available
- Isolated 24 VDC Transmitter Supplies 200 mA / Analog Input: 1,600 mA Max
- 99 Channels, 32 Totalizers, 30 Timers, & 199 Modbus Inputs
- 64 High & Low Alarms, Combine Multiple Alarms Into Logic AND & OR Alarms
- Simulation & Manual Control Modes for Testing and Setup
- Modular Design for Inputs & Outputs Flexibility
- Up to (28) Inputs; Isolated 4-20 mA, Pulse, or Temperature (Thermocouple or RTD)
- Up to (25) 10 Amp Form C Relays (With Eight Analog or Pulse Inputs)
- Up to (25) Isolated 4-20 mA Outputs (With Eight Analog or Pulse Inputs)
- Operating Temperature Range: -25°C to 55°C (-13 to 131°F)
- Print Critical Data from ConsoliDator+ with Printer Card
- Pulse, Analog, & Modbus Input Flow Rate / Total / Grand Total Capability
- 50-Point Linearization, Square Root, and Exponent for Open Channel Flow
- Round Horizontal Tank Volume Calculation; Just Enter Diameter & Length
- Open Channel Flow Math Formulas for Weirs & Flumes
- Multi-Pump Alternation with On-Off Multi-Setpoint Control and Lead-Lag Control
- HOA Switch Controls Pump Relays for Auto, Manual, or On/Off Modes
- Advanced Batch Control Features with Ticket Printing Capabilities
- Programmable Displays, Function Keys & Digital Inputs (Five Standard) and Optional 15-Digital Inputs Card Available
- Math Functions: Sum, Diff, Average, Multiply, Divide, % Efficiency, & More
- Modbus Client (Master) & Snooper / Server with 99 Programmable Outputs
- Direct Modbus PV Inputs – Snooper / Server Mode
- RS-485 Serial Communication with Modbus RTU / ASCII & Ethernet TCP/IP
- USB Data Logger Feature: Up to 8 Log Files with up to 12 Parameters Each
- Input Power Options: 90-264 VAC or 24 VDC
- (20) Screens with up to Eight PVs Each
- ConsoliDator+ Configuration Software
- Type 4X, IP66 Front – Field Enclosures Available
- Auto-Tune PID Control for Multiple Control Loops with Analog, Digital, or Relay Outputs
- 3-Year Warranty

PRECISION DIGITAL CORPORATION

233 South Street • Hopkinton MA 01748 USA
Tel (800) 343-1001 • (508) 655-7300

www.predig.com



Disclaimer

The information contained in this document is subject to change without notice. Precision Digital makes no representations or warranties with respect to the contents hereof and specifically disclaims any implied warranties of merchantability or fitness for a particular purpose. See Warranty Information and Terms & Conditions on www.prediq.com for complete details.

CAUTION

- Read complete instructions prior to installation and operation of the controller.

WARNINGS

- Risk of electric shock or personal injury.
- This product is not recommended for life support applications or applications where malfunctioning could result in personal injury or property loss. Anyone using this product for such applications does so at his/her own risk. Precision Digital Corporation shall not be held liable for damages resulting from such improper use.

WARNING
 Cancer and Reproductive Harm - www.P65Warnings.ca.gov

Limited Warranty

Precision Digital Corporation warrants this product against defects in material or workmanship for the specified period under “Specifications” from the date of shipment from the factory. Precision Digital’s liability under this limited warranty shall not exceed the purchase value, repair, or replacement of the defective unit. See Warranty Information and Terms & Conditions on www.prediq.com for complete details.

Registered Trademarks

All trademarks mentioned in this document are the property of their respective owners.

© 2025 Precision Digital Corporation.
 All rights reserved.

FREE ConsoliDator+ Configuration Software



The easiest and quickest way to program your ConsoliDator+ multivariable controller is to use the FREE ConsoliDator+ configuration software.

The ConsoliDator+ configuration software is intuitive, and most customers can get their controller programmed as they like without even looking in the manual.

Once your controller is programmed the way you want it, you can wire it up for your application per the instructions in this manual and install it. If you find that you need to adjust the programming after the controller is installed, you can use the front panel soft keys and the instructions in this manual to do so.

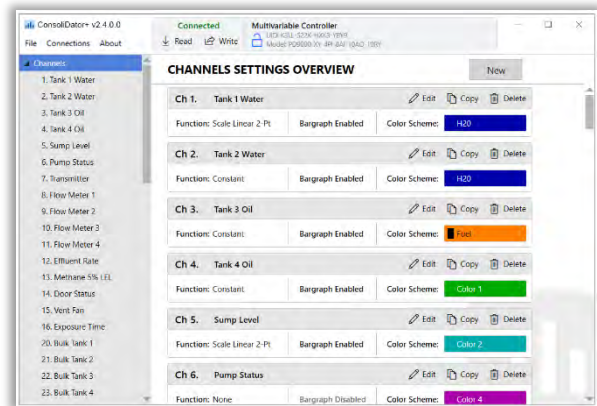

ConsoliDator+ configuration software is available for download at <https://www.prediq.com>.

Table of Contents

FREE ConsoliDator+ Configuration Software	2
Introduction.....	9
Ordering Information.....	10
Add-On Features.....	11
Input / Output Cards	11
Setup & Calibration Services.....	11
Ticket Printer & Accessories	11
Enclosures	12
ConsoliDator+ Enclosure Assembly Services	12
Accessories.....	13
Specifications	16
General	16
Totalizer	18
Batch Controller.....	18
Real Time Clock	18
Channel & Math Functions.....	19
List of Engineering Units	21
Pump Controller.....	21
4-20 mA Analog Inputs	22
Pulse Inputs	22
Modbus Inputs - Server	23
Digital Inputs	23
Temperature Input	23
Digital Outputs	23
Relays	24
4-20 mA Transmitter Outputs	24
Timers.....	24
Modbus Outputs - Server.....	25
Printer Card	25
Modbus Serial Communications	25
Modbus Client, Snooper & Spoofer.....	25
Client & Snooper Settings.....	26
Spoofer Settings	26
Data Logger – USB Drive	26
How to Enable Add-On Features.....	27
Sample Data Log File.....	27
Ethernet Communications	27
ConsoliDator+ Software	27
Compliance Information.....	28
Hazardous Area Location*	28
Ordinary Location*.....	28
Safety Information	29
Installation.....	29
Unpacking	29
Panel Mounting	29
Replacement Battery for Real Time Clock.....	29
Mounting Dimensions	30
ConsoliDator+ Configuration Software Installation	31
Connect to ConsoliDator+ Configuration Software	33
Connections.....	34
Power Connections	35
Isolated Input Signal Connections	35
4-20 mA Analog Input Connections	35
Temperature Input Connections	36
Flow Meter Pulse Input Connections	37
Digital Input Connections.....	37

- Analog Output Connections..... 37
- Digital Output Connections..... 37
- Connections to Power Gas Detector 38
- PDA9000-CP Printer Card Connection 38
- Relay Connections 39
- Switching Inductive Loads..... 39
- Serial Communication Connections 39
- External Keypad Connections 39
- Navigating and Editing..... 40**
- Soft-Keys and Buttons 40**
- Function Keys..... 40
- PID Function Keys..... 41
- Batch Control & Printer Keys..... 41
- Setup and Programming..... 42**
- Overview..... 42**
- Setup Menu 43**
- Channel Parameters 44**
- Data Entry Keypad..... 45**
- Setup Channels..... 46**
- Create New Channel 47
- Bargraph, Background & Text Colors..... 49
- Live Calibration..... 50
- Edit Channel..... 50
- Delete Channel..... 50
- Scale Functions..... 51
- 2-Point Linear Scaling 51
- Square Root Scaling 52
- Scale Exponent 53
- Round Horizontal Tank..... 53
- Open Channel Flow Application 54
- Setup Math Functions 56
- PID Control Setup 59**
- Setup Channel 1: PV 60
- Channel 2: Set Point 60
- Channel 3: Power..... 61
- Channel 4: PWM Control..... 61
- PID Control Using Digital Output 62
- PID Control Using Analog Output..... 62
- PID Control Using Mechanical Relays..... 62
- PID Control Screen 63
- Start / Stop PID with Digital Input 63
- Channel 3: PID Control - Power 64
- Channel 4: PWM Heating Control 64
- PID Control Heating Using Digital Output..... 65
- Channel 5: PWM Cooling Control..... 65
- PID Control Cooling Using Digital Output..... 65
- PID Control: Heating Using Analog Output..... 66
- PID Control: Cooling Using Analog Output..... 66
- PID Control Configuration Using ConsoliDator+ Software 67**
- Average Function Setup..... 67
- Configure PID Control Power Channel..... 68
- Configure PWM Control Heating Channel..... 69
- Configure PWM Control Cooling Channel 69
- Configure Set Point Channels 70
- Configure the Switches Function..... 71
- Configure the Digital Outputs 72
- Configure the PID Control Screens 73
- PID Control Screens..... 75

- Open Channel Flow 77**
- Setup Totalizers 78**
 - Setup Total with Pulse Input Source 78
 - Setup Accumulated Total (Triggered)..... 79
 - Setup Previous Total 79
 - Setup Daily Total 79
 - Setup Grand Total 80
- Setup Timers 81**
- Setup Alarms..... 82**
 - Logic OR Alarm 83
 - Logic AND Alarm..... 83
 - Logic NOR & NAND Alarms 83
 - Day & Time Alarms 84
- Setup the Switches Function 85**
 - Setup 2, 3, or 4-Way Switch 85
 - Setup a 4-Way Switch 85
- Setup HOA Switch 86**
 - Block Diagram for HOA Switch..... 86
 - Configuration for HOA Switch Application Using the Software 87
 - Setup HOA Switch..... 89
 - Setup HOA Relay 89
 - Setup HOA Screen 90
 - HOA Screen View 90
- Batch Controller..... 91**
 - Setup Batches 91
 - Setup Batch..... 92
 - Setup Batch Relays 93
 - Setup Batch Count 93
 - Setup Batch Grand Total..... 93
 - Setup Batch Screen 94
 - Batch Function Keys 95
 - Batch Screen Examples 95
 - Batch Control Examples 96
 - Manual Batch Control 100
 - Automatic Batch Control..... 103
- Printer Card Option..... 106**
 - Setup for Ticket Printing 107
 - Setup Print Ticket 107
 - Printer Settings Using ConsoliDator+ Software 108
 - Setup Print Tickets Menu 108
 - Batch Ticket Printing: Automatic..... 108
 - Batch Ticket Printing: Manual..... 109
 - Printer Setting Defaults..... 109
- Pump Controller Setup..... 110**
 - Channel Setup for Pump Control..... 110
 - Pump Alternation Channel..... 111
 - Pump Alternation Relays 112
 - Pump Control Annunciator Panel 113
 - Multi-Set Channel..... 114
 - Lead-Lag Control Channel 114
- Setup Inputs 116**
 - Setup 4-20 mA Inputs..... 116
 - Setup Pulse Inputs 118
 - Setup Temperature Inputs..... 119
 - Setup Digital Inputs 120
 - Digital Inputs & Data Logger..... 122
 - Modbus Functionality 123
 - Setup Modbus Inputs (Server)..... 123

- Setup Modbus Inputs (Client) 124
- Setup Modbus Inputs (Snooper)..... 124
- Setup All Outputs..... 125**
 - Setup 4-20 mA Outputs 125
 - Setup Relay Output 126
 - Setup Digital Output 127
 - Setup Modbus Output (Server)..... 127
 - Setup Modbus Output (Client) 128
 - Setup Modbus Output (Spoofers)..... 129
- Setup Screens 130**
 - Screens Settings 130
- Setup Data Logs 133**
 - Setup New Data Log 133
 - Setup Log Start / Stop 134
 - Setup Log Enable Switch 134
 - Setup Log Trigger..... 135
 - Setup Log Interval & Log Units..... 136
 - Setup USB Drive 136
- View Data Logs 137**
- Setup System 138**
 - Setup Display 138
 - Setup Colors..... 138
 - Display Settings..... 138
 - General Settings..... 139
 - How to Enable Add-On Features..... 139
 - Set Password 140
 - Password Protected Controller..... 140
 - Remove Password Protection 140
 - System Date & Time 141
 - System Build 141
 - Modbus Server Settings 142
 - Modbus Client Settings..... 142
 - Modbus Snooper Settings 142
 - Modbus Monitor..... 143
 - Ethernet Settings..... 144
 - Manually Assigned IP Address 144
 - Custom Units..... 145
 - Delete Custom Units 145
- Ethernet Port Setup - Full 146**
- Test Ethernet Communication 148**
- View Menu 149**
 - View Channel Details..... 149**
 - View Associated Parameters..... 150
 - View Alarm Details..... 150**
 - View Batches..... 151**
 - View Totals 151**
 - Totals Generated by Non-Rate Inputs 152
 - View Timers..... 154**
 - View Alarms 155**
 - Simulate Alarm Condition 155
 - View Inputs..... 156**
 - Simulate mA Input 156
 - View Outputs 157**
 - View mA Outputs..... 157
 - View Relays..... 158
 - View Alert Messages 158
 - View Digital Outputs 159**
 - View Modbus Outputs 159**

View Screens..... 160

Operation..... 161

Viewing Screens 161

 Individual Channel View 161

 Low & High Alarm Indication 161

 Multicolor Bargraph Indication 162

Modbus RTU & ASCII Serial Communication..... 163

Modbus Register Tables 163

PVs Register Numbers & Addresses 165

Modbus Write Protection 166

Modbus Applications 171

Snooper Mode..... 171

Relay Control Using Modbus 172

 Setup Example #1 172

 Setup Example #2 172

Troubleshooting Tips..... 173

Table of Figures

Figure 1. Front Panel Mount Dimensions	29
Figure 2. Panel Cutout Dimensions	29
Figure 3. Panel Mount Installation	30
Figure 4. Panel Mount Overall Dimension	30
Figure 5. Connection Terminals for a PD9000-6N-4PI-4AI-4TI-5AO-5RY-15DI-E-P .	34
Figure 6. AC Power Connections	35
Figure 7. DC Power Connections	35
Figure 8. Transmitters Powered by ConsoliDator+ Isolated 24 VDC Power Supply	35
Figure 9. Transmitter Powered by External Supply or Self-Powered.....	35
Figure 10. 3-Wire Transmitters Powered Externally	35
Figure 11. Thermocouple Input Connections.....	36
Figure 12. Two-Wire RTD Input Connections.....	36
Figure 13. Three-Wire RTD Input Connections	36
Figure 14. Four-Wire RTD Input Connections.....	36
Figure 15. Flow Meter Pulse Input Connections	37
Figure 16. Digital Input from Switch Closure and Live Signal	37
Figure 17. Active 4-20 mA Output Powered by Controller	37
Figure 18. Passive 4-20 mA Output Powered by External Supply.....	37
Figure 19. Digital Outputs Driving 5 V Solid State Relay	37
Figure 20. Two Supplies in Parallel Powering 3-Wire Transmitter	38
Figure 21. Powering 4-Wire Gas Detector & Isolated 4-20 mA Output.....	38
Figure 22. Printer Connections	38
Figure 23. Relay Connections	39
Figure 24. AC and DC Internal Inductive Loads Protection	39
Figure 25. Low Voltage DC Loads Protection	39
Figure 26. Serial Connections	39
Figure 27. External Keypad Connections.....	39
Figure 28. Linear Response Graph	51
Figure 29. Square Root Response Graph.....	52
Figure 30. Exponent Response Graph.....	53
Figure 31. Round Horizontal Tank Volume Graph	53
Figure 32. Total Relay Sampling Operation	54

Introduction

The ConsoliDator+ is a multivariable controller that is both easy to use and satisfies a wide variety of process display, alarm, and control applications. It accepts 4-20 mA inputs, flow meter pulse inputs, temperature inputs, digital inputs, and Modbus inputs and displays them in both numeric and bargraph format on a large, 5.7" color display.

It can be equipped with multiple relays with user-definable actions, 4-20 mA outputs, digital outputs, Modbus RTU & ASCII, Modbus Enron, and Ethernet Modbus TCP/IP protocol communication.

Additionally, the controller is equipped with up to 30 timers that can be used to control many processes or events.

New features that have been recently added to the ConsoliDator+ include:

- (4) Temperature Inputs Card
- (15) Digital Inputs Card
- Auto-Tune PID Control
- Digital Switches (HOA)
- Advanced Batch Control Features
- Print batch tickets, process variables, and other critical data
- Pump Alternation with On-Off Multi-Setpoint and Lead-Lag Control

The ConsoliDator+ takes full advantage of its color display by allowing the user to customize screen colors for bargraphs, alarm conditions, and input channels.

All this functionality is easily programmed using the free software or via the front panel pushbuttons. Choose the model that best suits your application, from monitoring only to fully loaded controllers with an extensive combination of inputs, outputs, and communication protocols.

The standard product offering is listed in the ordering guide and other models are available for special order. The Add-On features expand the functionality of the ConsoliDator+, see the next page for details.

Most ConsoliDator+ models have been Certified by Underwriters Laboratory (UL & C-UL) for use in ordinary locations (electrical safety) and in Div 2 hazardous area locations (nonincendive). See *Ordering Information* for complete details.

Ordering Information

Required Optional. If none ordered, leave the field blank. Example model entered in gray numbers and letters.

PD9000- **6** **G** - **4** **AI** - **4** **PI** - **5** **AO** - **10** **RY** - **E** - **P**

Enter Number of Analog Inputs

# Inputs	# Cards ²
4	1
8	2
12	3
16	4
20	5
24	6
28	7

Input Type
AI Analog Inputs

Enter Number of Digital Inputs³

# Inputs	# Cards ²
15	1
30	2
45	3
60	4
75	5
90	6
105	7

Input Type
DI Digital Inputs

Enter Number of Pulse Inputs

# Inputs	# Cards ²
4	1
8	2
12	3
16	4
20	5
24	6
28	7

Input Type
PI Pulse Inputs

Enter Number of Temperature Inputs

# Inputs	# Cards ²
4	1
8	2
12	3
16	4
20	5
24	6
28	7

Input Type
TI Temperature Inputs

Enter Number of Analog Outputs

# Outputs	# Cards ²
5	1
10	2
15	3
20	4
25	5
30	6
35	7

Output Type
AO Analog Outputs

Enter Number of Relays

# Relays	# Cards ²
5	1
10	2
15	3
20	4
25	5
30	6
35	7

Relays
RY Relays

Printer Device
P Printer Card²

Ethernet
E Ethernet

Example Model Numbers:

PD9000-6G-4AI-4PI-5AO-10RY-E
90-264 VAC, UL Listed for Ordinary Location.
Includes: 4 Analog Inputs, 4 Pulse Inputs, 5 Analog Outputs, 10 Relays, and Ethernet

PD9000-7H-4AI-4PI-5AO-10RY-E
24 VDC, UL & C-UL for Hazardous Areas.
Includes: 4 Analog Inputs, 4 Pulse Inputs, 5 Analog Outputs, 10 Relays, and Ethernet

PD9000-6N-4AI-15DI-4TI-5AO-5RY-P
90-264 VAC, No Approvals.
Includes: 4 Analog Inputs, 15 Digital Inputs, 4 Temperature Inputs, 5 Analog Outputs, 5 Relays, and Printer Card

Approvals

G	General Purpose: Electrical Safety Certification UL & C-UL (E160849)
H	Hazardous Area Certification Nonincendive Division 2 UL & C-UL (E516990)
N	No Approvals ¹

Power Options

6	90-264 VAC
7	24 VDC

(1) "N" No Approvals is a requirement when the ConsoliDator+ includes any temperature input cards, digital input cards, or the printer card. All other builds without these options must be either G or H models.

(2) The ConsoliDator+ may have up to 7 I/O cards. Up to 6 relays cards, or any other 7-card combination. The printer card occupies one I/O slot.

(3) 5 digital inputs are standard on all models. Additional digital inputs available using I/O cards.

[Go To www.predig.com/PD9000ModelGen](http://www.predig.com/PD9000ModelGen)
 To Create Your ConsoliDator+ Model Number

Add-On Features

Model	Description
PDK9000-M1	Add-On Feature: ConsoliDator+ Modbus Client/Snooper/Spoofers (Ver. 2.1 & Up)
PDK9000-D1	Add-On Feature: ConsoliDator+ USB Data Logger (Ver. 2.2 & Up)
PDK9000-B1	Add-On Feature: ConsoliDator+ Batch Control (Ver. 2.4 & Up)

Note: Add-On features that are ordered with the ConsoliDator+ will be activated at the factory. Add-On features can be ordered for existing ConsoliDator+ provided the firmware version meets or exceeds those listed above. The user will receive a key they can enter into the ConsoliDator+ to unlock the Add-On feature. See page 139 for instructions on *How to Enable Add-On Features*.

CAUTION

- Do not write configuration files created with older versions of the firmware and software to controllers with Add-On features enabled (Ver. 2.1 & up). This can create undesirable results, especially with the function keys F1-F4 and the digital inputs.

IMPORTANT

- The Auto-Tune PID Control and the Digital Switch functions are standard on versions 2.3 & up.

Input / Output Cards

Model	Description
PDA9000-C4AI	(4) Isolated 4-20 mA Inputs Card for ConsoliDator+
PDA9000-C4PI	(4) Pulse Inputs Card for ConsoliDator+
PDA9000-C4TI	(4) Temperature Inputs Card for ConsoliDator+*
PDA9000-C15DI	(15) Digital Inputs Card for ConsoliDator+*
PDA9000-C5AO	(5) Isolated 4-20 mA Outputs Card for ConsoliDator+
PDA9000-C5RY	(5) Relays Card for ConsoliDator+
PDA9000-CP	ConsoliDator+ Printer Card*

*ConsoliDator+ models equipped with temperature input cards, digital input cards, or printer card are not UL Listed. The printer card occupies one I/O slot.

Setup & Calibration Services

Part Number	Description
PDN-CALCON+12	ConsoliDator+ Calibration and Certificate for up to 12 Inputs and Outputs
PDN-CALCON+24	ConsoliDator+ Calibration and Certificate for up to 24 Inputs and Outputs
PDN-CALCON+36	ConsoliDator+ Calibration and Certificate for up to 36 Inputs and Outputs
PDN-CALCON+12-DATA	ConsoliDator+ Calibration and Certificate with data for up to 12 Inputs and Outputs
PDN-CALCON+24-DATA	ConsoliDator+ Calibration and Certificate with data for up to 24 Inputs and Outputs
PDN-CALCON+36-DATA	ConsoliDator+ Calibration and Certificate with data for up to 36 Inputs and Outputs
PDN-CSETCON+	Custom Setup for ConsoliDator+, Up to 4 Hours
PDN-CSETCON+HOUR	Additional Hour Setup for ConsoliDator+

Ticket Printer & Accessories

Model	Description
PD920-DP	Desktop Impact Printer, Plug-in Power Supply, and 10 ft DB9F to DB25M Null Modem Cable
PDA920-DP-WMK	Desktop Printer Wall Mount Kit
PDA9000-CP	ConsoliDator+ Printer Card*

*ConsoliDator+ models equipped with a printer card are not UL Listed, and the printer card occupies one I/O slot.

Enclosures

Model	Description
PDA1909	NEMA 4X Plastic Enclosure for One ConsoliDator+ ⁽¹⁾ Dimensions: 11.8" x 11.8" x 5.9" (300 mm x 300 mm x 150 mm) (W x H x D)
PDA1939	NEMA 4X Plastic Enclosure for One ConsoliDator+ Dimensions: 13.8" x 17.7" x 7.9" (350 mm x 450 mm x 200 mm) (W x H x D)
PDA2909	NEMA 4 Steel Enclosure for One ConsoliDator+ ⁽¹⁾ Dimensions: 12.0" x 12.0" x 6.0" (305 mm x 305 mm x 152 mm) (W x H x D)
PDA2919	NEMA 4 Steel Enclosure for One ConsoliDator+ Dimensions: 12.0" x 14.0" x 8.0" (305 mm x 356 mm x 203 mm) (W x H x D)
PDA2929	NEMA 4 Steel Enclosure for One ConsoliDator+ Dimensions: 14.0" x 16.0" x 10.0" (355 mm x 406 mm x 254 mm) (W x H x D)
PDA3939	NEMA 4X Plastic Enclosure with Clear Cover for One ConsoliDator+ Dimensions: 13.8" x 17.7" x 7.9" (350 mm x 450 mm x 200 mm) (W x H x D)

1. Due to the limited amount of internal space available for these enclosures they are recommended for PD9000s with only a minimal amount of option cards installed.

ConsoliDator+ Enclosure Assembly Services

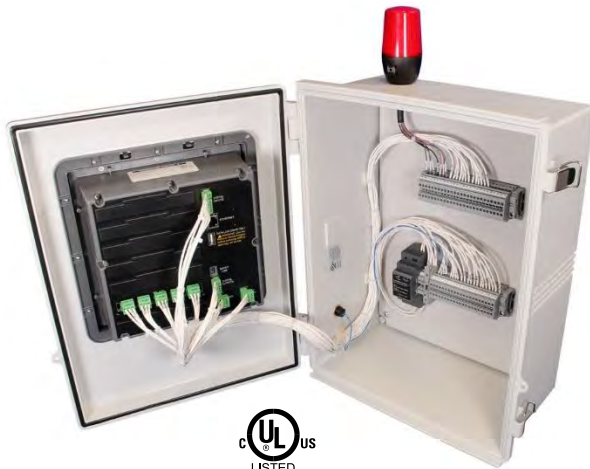

Enclosed Industrial Control Panel

Key Features

- Complete Assembly Services with Instruments, Enclosure, Accessories, and Other Components
- Fully Assembled and Wired, Ready for Use
- Includes Backplane and Din Rail Terminal Strips for Connections
- Meticulously Labeled and Professionally Managed Wiring
- Ready for Straightforward On-Site Installation
- Certified as UL/C-UL Enclosed Industrial Control Panels*

*Panels installed with temperature input cards, digital input cards, or printer card are not UL/C-UL panel rated.

Precision Digital offers comprehensive enclosure wiring and assembly services for its PD9000 ConsoliDator+ to provide customers with a fully assembled and wired enclosure that is ready to connect to field devices. All enclosure assemblies are certified as UL/C-UL Enclosed Industrial Control Panels.

In addition to installing and wiring the PD9000, other components such as light and horn towers, buttons, power supplies and other devices a customer may want can be installed and wired.

All field wiring is made to DIN rail terminal strips at the base of the enclosure.

Enclosure Assembly Services are available only on the following enclosures: PDA1939, PDA2919, PDA2929, and PDA3939.

See [PD9000-ENC Data Sheet](#) for More Details and Ordering Information.

Accessories

Note: The products described on the following pages are not intended to be used in hazardous locations.

Light / Horn Accessories



Model	Description
MOD-LHRB1	Red Light / Horn and Button with Holes Drilled in Enclosure ⁽¹⁾
MOD-LHGB1	Green Light / Horn and Button with Holes Drilled in Enclosure ⁽¹⁾
MOD-LHYB1	Yellow Light / Horn and Button with Holes Drilled in Enclosure ⁽¹⁾
MOD-LHBB1	Blue Light / Horn and Button with Holes Drilled in Enclosure ⁽¹⁾
MOD-LHWB1	White Light / Horn and Button with Holes Drilled in Enclosure ⁽¹⁾
MOD-LH5CB1	Light / Horn with User Choice of Red, Green, Yellow, Blue or White Light, Button, and Holes Drilled in Enclosure ⁽¹⁾
MOD-LH3LCB1-RYG	Light / Horn with Red, Yellow, Green Light Layers, Button, and Holes Drilled in Enclosure ⁽¹⁾
PDA-LHR	Red Light / Horn
PDA-LHG	Green Light / Horn
PDA-LHY	Yellow Light / Horn
PDA-LHB	Blue Light / Horn
PDA-LHW	White Light / Horn
PDA-LH5C	Light / Horn with User Choice of Red, Green, Yellow, Blue or White Light
PDA-LH3LC-RYG	Light / Horn with Red, Yellow, Green Light Layers

Note:

- This MOD supplies the Light / Horn and Button. The enclosure comes pre-drilled with holes for Light / Horn and Button and the user performs the installation and wiring. ConsoliDator+ and enclosure are sold separately. The Light / Horn hole is located on the top left corner of the enclosure and the Button is located on the bottom left side of the enclosure.

PDA-BUTTON Momentary Pushbutton



Model	Description
PDA-BUTTON1B	NEMA 4X Black Button
PDA-BUTTON1G	NEMA 4X Green Button
PDA-BUTTON1R	NEMA 4X Red Button

PDA9000SH Sun Hood



Model	Description
PDA9000SH	ConsoliDator+ Stainless Steel Sun Hood

UL Requirements: For use on a flat surface of a UL Type 4X Enclosure. The 4X sun hood must remain in place in order to maintain the 4X Rating. Installed to 7 lb-in (0.8 Nm).

PDA2360 Control Stations



Model	Description
PDA2360-E	Emergency Stop Button
PDA2361-A	1 Black Ack Button
PDA2361-Q	1 Black Silence Button

PD9501 Multi-Function Calibrator



Model	Description
PD9501	Multi-Function Calibrator

Signal Splitter & Conditioner Accessories



Model	Description
PD659-1MA-1MA	Signal Isolator with One 4-20 mA Input and One 4-20 mA Output
PD659-1MA-2MA	Signal Splitter with One 4-20 mA Input and Two 4-20 mA Outputs
PD659-1V-1MA	Signal Conditioner with One 0-10 VDC Input and One 4-20 mA Output
PD659-1MA-1V	Signal Conditioner with One 4-20 mA Input and One 0-10 VDC Output

PDA1024-01 Power Supply



Model	Description
PDA1024-01	24 VDC Power Supply for DIN Rail

Split Core AC Current Transducer



Model	Description
PDA6420	Split Core AC Current Transducer. Input: 30/60/120 AAC; Output 4-20 mA

Panel Mount Buzzer and Light



Model	Description
PDA1000	Panel Mount Buzzer and Light

Snubber 0.01µF/470Ω Flexible Leads



Model	Description
PDX6901	Snubber 0.01µF/470Ω Flexible Leads

Low-Cost Signal Generator



Model	Description
PD9502	4-20 mA or 0-10 VDC, Low-Cost Signal Generator

Printer & Accessories



Model	Description
PD920-DP	Desktop Impact Printer, Plug-in Power Supply, and 10 ft DB9F to DB25M Null Modem Cable
PDA920-DP-WMK	Desktop Printer Wall Mount Kit
PDA9000-CP	ConsoliDator+ Printer Card*

*ConsoliDator+ models equipped with a printer card are not UL Listed, and the printer card occupies one I/O slot.

PD9000-ENC ConsoliDator+ NEMA 4X Plastic and NEMA 4 Steel Enclosures

The PD9000-ENC enclosures provide a convenient way to mount the PD9000 ConsoliDator+ to walls and other vertical structures. The enclosures are available in painted steel and plastic and come pre-cut with one cutout to mount the PD9000. The enclosures are available in various sizes, with the larger enclosures capable of housing other pieces of equipment, such as the PDA1024-01 power supply.

Note: The enclosure and ConsoliDator+ are ordered and packaged separately.

Features

- House One ConsoliDator+ PD9000
- Cutout for One ConsoliDator+ Provided
- ConsoliDator+ Mounts in Cover
- ConsoliDator+ Mounts Inside PDA3939 Clear Cover
- Sub-Panels Available
- PDA6909 Pipe Mounting Kit Available
- Light / Horn & Reset Button Available
- UL Listed Plastic Enclosures
- UL Listed, CSA Certified Steel Enclosures

UL Type 4X / NEMA 4X Plastic Enclosures



PDA1909⁽¹⁾
 Dimensions: 11.8" x 11.8" x 5.9"
 (300 mm x 300 mm x 150 mm)
 (W x H x D)



PDA1939
 Dimensions: 13.8" x 17.7" x 7.9"
 (350 mm x 450 mm x 200 mm)
 (W x H x D)



PDA3939
 Dimensions: 13.8" x 17.7" x 7.9"
 (350 mm x 450 mm x 200 mm)
 (W x H x D)

UL Type 4 / NEMA 4 Steel Enclosures



PDA2909⁽¹⁾
 Dimensions: 12.0" x 12.0" x 6.0"
 (305 mm x 305 mm x 152 mm)
 (W x H x D)



PDA2919
 Dimensions: 12.0" x 14.0" x 8.0"
 (305 mm x 356 mm x 203 mm)
 (W x H x D)



PDA2929
 Dimensions: 14.0" x 16.0" x 10.0"
 (355 mm x 406 mm x 254 mm)
 (W x H x D)

Note:

1. Due to the limited amount of internal space available for these enclosures they are recommended for PD9000s with only a minimal amount of option cards installed.

For More Details Download the PD9000-ENC Data Sheet

Download free 3-D CAD files of these enclosures to simplify your drawings!

predig.com/documentation-cad

Specifications

Except where noted all specifications apply to operation at 25°C (77°F)

General

Display	Color; QVGA (320 x 240 pixels), 5.7" (145 mm) diagonally, white backlight Bargraph: Twenty divisions Numerical: Up to 15 digits (±999,999,999,999,999) Feet & Inches Format: 99,999' 11.9"
Screen Bargraph	Enable/disable: Channels, totals, timers Bargraph scale: 0 – 100%, independent of channel scale. Twenty divisions: 5% each. Screen: Select to show bargraph or not.
Color Selection	65 colors selection Customize bargraph, panel background, and text for normal and alarm conditions.
Decimal Point	0 to 15 decimal places, user selectable
Engineering Units	User selectable units or custom units Time, Distance, Volume, Pressure, Weight, Temperature, Current, Voltage, Percent, Amps, Volts, Counts, Logic, and Custom, Any unit/unit of time or other units. See page 21 for list of units.
Feet & Inches Units	Data entry format: Decimal (e.g. 50.58 feet) Display format: 50' 6.96"
Units Conversion	Units' conversion is supported for channels, totals, timers, and any function using those parameters. Channel scaling must be in the intended base units (e.g. Gallons/min)
Boot-Up Time	Less than 10 seconds All inputs and outputs
Display Update Rate	User selectable: 0.1 to 0.5 sec (10 updates/sec to 2 updates/sec)
Programming Method	Front panel buttons, external buttons, or ConsoliDator+ Software
Number of Alarms	Up to 64 high or low, Logic AND & OR Automatic (non-latching) or latching On & Off time delays Can be assigned to one or more relays. Note: Alarms are independent from relays.
Alarm Types	Single Source: One input Multi-Source: Two or more inputs Interval: Enter time interval and On Time Day & Time: Select day of the week & time Alarm OR: Any active input alarm triggers the OR alarm Alarm AND: All alarms must be active to trigger the AND alarm
Alarm Ack & Reset	Automatic only (Non-latching) Automatic and manual Manual only (Latching) Manual with Ack only after alarm is cleared (Latching with Clear)
Alarm Indication	1. Bargraph, panel, and text can be set up to change color on alarm 2. Enable internal buzzer 3. Assign external relay to drive a horn
Internal Buzzer	60 dBA @ 24 inches (61 cm) Enable/disable in System – General menu Associated with alarm Horn setting

External Horn (Sold Separately)	Assign any relay to the Horn function to activate an external horn when alarm condition is detected.
Live Channel Calibration	Live calibration of channels is independent of the input calibration used for scaling.
Input & Output Cards	Max Number of I/O Cards: 7 Analog Inputs: 4/card Pulse Inputs: 4/card Temperature Inputs: 4/card ⁽¹⁾ Digital Inputs: 15/card ⁽¹⁾ Analog Outputs: 5/card Relays: 5/card ⁽³⁾ Printer: 1/card. ^{(1) (2)} 1. Models equipped with these cards are not UL Listed. 2. Printer card occupies one I/O slot. 3. Max number of relay cards is 6.
Number of Screens	Up to 20 screens with 1 to 8 PVs or items per screen Enable or disable screen title, channel #, and bargraph Automatic or manual scanning Scan time: 1 to >1000 sec, independent for each screen F1-F4 keys are assigned per screen
Function Keys	User programmable (See defaults below) F1 = Previous ← F2 = Next → F3 = Scan/Stop F4 = Ack
Number of Channels	Up to 99 channels Input Source: 4-20 mA, Pulse, Digital, Modbus, another Channel, Total, Timer, Alarm, Date & Time, mA Output, Relay Output, Digital Output, or Modbus Output
Channel Functions	There is an extensive number of functions that can be applied to the inputs, see <i>Channel & Math Functions</i> on page 19.
Number of PID Control Channels	Up to (8) PID control loops can be set up with (8) analog inputs and (8) analog outputs. Note: (2) analog input cards and (2) analog output cards are used. The (3) remaining slots can be used for relays. Contact Tech Support if more than (8) PID loops are needed.
Programmable Switches	Up to (32) programmable digital switches can be used to route any input, output, or process variable.
Password	Programmable password restricts modification of programmed settings. View and Setup menus are password protected, function keys and digital inputs are not protected.
Simulation Mode	Inputs, channels, totals, timers, and alarms can be simulated from the View menu or from a function key. Simulation mode is not saved on power down. Alert! message is provided for simulated items.

Manual Control	Analog outputs and relays can be controlled manually from the View menu or from a function key. Manual control mode is not saved on power down. Alert! message is provided for outputs in manual control. Note: If it is necessary to turn relays off and maintain the condition through power cycle, configure the relays to Always Off.
Non-Volatile Memory	Settings stored for a minimum of 10 years.
AC Powered Models (-6)	Three-terminal connector (L, N, GND) 90-264 VAC, 47 to 63 Hz, 60 W max
DC Powered Models (-7)	Two-terminal connector (G, 24V) 24 VDC ±10%, 60 W max Means of Protection: Class 2 (Reinforced) Overvoltage Category: Class II
Fuse	Units are protected internally with auto-resettable fuse AC: 1.25 A max DC: 3.7 A max
External Fuse	Recommended external fuse slow-blow 120 VAC: 2.0 A 240 VAC: 1.0 A 24 VDC: 4 A
Isolation & Grounding	1500 V Analog inputs/outputs-to-power line 500 V Analog input-to-input, input-to-output, analog output-to-output All analog inputs and analog outputs are isolated from each other.
Environmental	Operating temperature range: -25 to 55°C (-13 to 131°F)* Storage temperature range: -40 to 60°C (-40 to 140°F) Relative humidity: 0 to 90% non-condensing
Front Sealing	Type 4X, IP66
Pollution Degree 2	
Maximum Altitude	2000 m (6,562 feet)
Internal Fan	Automatic temperature-controlled fan turns on if the inside temperature reaches 50°C and increases the speed as the temperature rises to 60°C.
Internal Heater	Automatic temperature-controlled heater located behind the LCD turns on at 0°C, delivering the minimum power. If the temperature drops below -10°C, the heater delivers its maximum power.
Connections	Removable screw terminal blocks Inputs/Outputs: 12 to 24 AWG wire Digital I/O: 16 to 30 AWG RS-485: 12 to 24 AWG wire RJ45 Ethernet connection USB ports: Micro-USB used for programming; cable included. Data Log Drive: Type A, used with Data Logger Add-On feature.
Tightening Torque	Screw terminal connectors: Analog I/O & Relays: 0.5 Nm (4.5 lb-in) Digital I/O terminals: 0.23 Nm (2 lb-in)

Enclosure	Enclosure Body: Thermoplastic Polyester Color: Gray Display Window: Clear Polycarbonate, GE LEXAN HP12W Front Panel Keys: Silicone rubber
Mounting	Panel-mounting frame and twelve screws (provided) Cutout: 10.0" x 10.0" ±0.05" (254 mm x 254 mm ±1.3 mm) (H x W) Panel thickness: 0.07" – 0.35" (1.8 mm – 8.9 mm) Clearance behind panel: 6" (152 mm)
Overall Dimensions	10.85" x 10.85" x 4.87" (276 mm x 276 mm x 124 mm) (H x W x D)
Weight	Ex: PD9000-XY-4PI-8AI-10AO-10RY 7.4 lb (3.4 kg) approx.
Field Enclosure	This device is an open-type controller and is required to be installed in a suitable enclosure that can only be accessed with the use of a tool or key. Panel mounting fasteners shall be tightened to a torque value of 0.8 Nm (7 lb-in).
Warranty	3 years parts and labor. See Warranty Information and Terms & Conditions on www.prediq.com for complete details.

Totalizer

Number of Totalizers	Up to 32 totalizers 15 digits with comma separator
Totalizer Inputs	Calculates total based on selected rate channel, pulse input, digital input, or triggered event for non-rate channels. Total is stored in non-volatile memory if power is lost.
Maximum Total	18 digits 999,999,999,999,999,999
Rate Channel Input	4-20 mA input, Pulse input, Modbus input
Rate & Total Decimal Point	Independent and user selectable from 0 to 15 places
Totalizer Reset	Via front panel keys or digital inputs
Non-Resettable Total	Total can be set up to be non-resettable to prevent unintentional reset. This can be changed in the Setup Totals menu.
Total Units Conversion	Input: Rate channel Total units can be different than rate units. Use the custom units to convert to any unit (e.g. Gallons to Billion gallons BGAL: Factor = 0.000000001)
Pulse Input K-Factor	K-Factor = pulses/units of measure Calculates total directly from pulse input, Modbus input, channel, total, or Modbus output. Create rate channel by entering K-Factor, units and time base in sec, min, hr, or day. Decimals: 0 to 15
Count Down	Total can set up to count down from a predetermined value entered by the user.
Preset Value	Enter the preset value to count up or down. Reset total sets total to the preset value; to reset to zero uncheck the Preset box.
Roll-Over	Enter the value for total to roll-over to 0 Example: Roll-Over = 1,000,000 Total goes to 0 after 1 million
Negative Total	Allow total value to count below 0 for bi-directional flow based on rate channel
Total Bargraph	Bargraph can be scaled to represent the expected maximum total
Function Keys	Screen Setup: Assign F1-F4 to Reset Total, Enter Total, Add To, or Remove From Total
Previous Total	This is the total prior to the last reset. Multiple previous totals can be set up by selecting a previous total as the input to a new total. The date & time is captured with the previous total.
Daily Total	This is the total for the day, starting at midnight. Daily total can be the input for previous totals to keep a record of a few days. The date is captured with the previous total.
Grand Total	Uses another total as the input and it is set up as non-resettable
Non-Rate Total	This total takes the input from a non-rate channel, a trigger causes the total to increment, or decrement based on the settings selected (e.g. Input from weight scale added when digital input is triggered).

Batch Controller

Availability	Order Add-On Feature model PDK9000-B1 at any time. (Cons+ firmware version 2.4 or greater) See <i>How to Enable Add-On Features</i> on page 139.
Methods	Automatic or Manual, count up or count down
Auto Correct	Select auto correct to automatically correct minor deviations of the delivered batch from the preset value. Test batches must be run until the correct batch is obtained.
Manual Batch Start	Assign a function key to start the batch
Manual Batch Pause/Stop	Assign a function key to pause or stop the batch. A paused batch can be resumed or stopped.
Batch Start Delay	The start delay applies to manual or automatic batch modes.
Automatic Batching	The batch can be run automatically, where the batches run continuously without operator input, after started.
Automatic Batch Restart Delay	The batch will automatically restart after completion of the last batch and the automatic delay. This time is in addition to the start delay, if selected.
Batching Relay Operation	Single or dual-relay batching with optional preclose for dual-stage operation.
Batch Preset	Assign a function key to change the preset quickly without navigating the menu.
Batch Preclose	For two-stage batch application, a preclose value can be set to close the main flow line before the preset is reached.
Pre-Start Action	Select what happens before the batch starts running (e.g. Turn on a horn/light to alert the operator).
Start Action	Select action when batch starts.
Pre-Close Action	Select action when pre-close is reached.
Finish Action	Select action when the batch is completed.
Batch View Screen	The batch view screen provides information about the batch setup (inputs & outputs) and the batch control functions (e.g. Start/Stop, Print, Partial, Force On).
Batch Control	The control functions can be accessed from the View menu or a function key.
Partial Batch	A partial batch can be entered to test the system before running a full batch.
Force On/Off	Batch relay(s) can be forced on or off from the View menu or a function key.

Real Time Clock

Date Format	Month, day, year (e.g. July 16, 2024)
Time Format	24 hour; 00: Midnight hh:mm:ss
Battery	3V, P/N: CR2032 included Battery replacement only with a Panasonic CR2032 Lithium Metal 3V coin cell battery.
Display Date & Time	Displayed on the top line of Setup and View menus, including day of the week.
Screens	Date & Time can be added to any screen.
Channels	Date & Time can be the input to a channel. Display Format: yyyy/mm/dd hh:mm:ss

Channel & Math Functions

Scale Functions	
K-Factor	Converts number of pulses to volume or other units
Scale Factor	Apply multiplier to a channel
Scale Linear 2-Pt	Scale a channel
Scale Multi-Point*	Multi-point scaling of a channel
Scale Square Root	Apply square root to a channel – Differential Pressure from two channels
Scale Exponent	Apply exponent for weirs and flumes open channel flow calculation
Round Horizontal Tank	Calculate volume in round horizontal tank with flat ends
Units Conversion	Convert base units to any units
Percent (Bargraph)	% bargraph of any: 4-20 mA input, channel, total, timer, or mA output
Text (Percent)	Text displayed based on the % input value
Math Functions	
Constant	Assign fixed value
Summation	Add two or more channels
Difference	Subtract any two channels
Abs Difference	Difference always positive
Absolute Value	Convert channel value to positive
Average	Find the average of channels
Weighted Average	Assign % weight to two or more channels
Multiply	Multiply two channels
Divide	Divide two channels
Exponent	Set the base and the exponent; both can be constants or variables
Logarithm	Set the base and the value; both can be constants or variables
Polynomial	Calculate single variable 5th degree polynomial
Modulo	Set constants or variables for A mod B
Trigonometry	Sine, cosine, tangent, arc sine, arc cosine, arc tangent. Select the input and angle
% Efficiency	Calculate input to output efficiency ((A-B)/A)*100%

Open Channel Flow Functions	
Parshall Flumes	$Q = K H^n$ Enter constant, head variable, exponent, and units
V-Notch Weirs	$Q = K H^{2.5}$ Enter constant, head variable, and units
Cipolletti Weirs	$Q = K L H^{1.5}$ Enter constant, crest length, head variable, and units
Rectangular Weirs w/o Contractions	$Q = K L H^{1.5}$ Enter constant, crest length, head variable, and units
Rectangular Weirs with Contractions	$Q = K (L - 0.2H) H^{1.5}$ Enter constant, crest length, head variable, and units

Note: Enter K value for $Q = \text{cuFt/sec}$; select any flow rate units to be displayed or used as input to a totalizer.

IMPORTANT
***Scale Multi-Point:** There is no minimum input span requirement; it is up to the user to make sure the input values are correct.

Additional Functions	Compare	
	Greatest	Greatest value in a group of channels
Least	Smallest value in a group of channels	
Middle of 3	Outputs the middle value of three inputs	
Less Than	Calculate True/False if A is less than B	
Measure		
Tare	Calculate net value when Tare function is applied via function key	
Maximum	Maximum value reached by the process	
Minimum	Minimum value reached by the process	
Duration	Keep track of time a condition has been present (e.g. high alarm active)	
Rate of Change	Calculates how fast a process is changing /sec, /min, /hr, /day	
Filter		
Window Average	Enter time to calculate the average	
IIR (First Order)	Infinite Impulse Response (slow)	
Cutoff	PV = 0 below cutoff Flip Side: 0 above (-)	
Limits	Sets PV upper & lower limits.	
Round	Round (to nearest) Floor (always down) Ceiling (always up) Less (toward zero) More (away from zero)	
Hysteresis	Resists a directional change using a time delay, filters change in the trending direction	
Delay	Enter the number of seconds to delay the output	
Pulse Filter	Use to filter discrete inputs, set minimum and maximum on/off time in seconds	

Control	
Sampler	Trigger relay sample and select sampling time (e.g. Turn relay on for 30 sec every time total increases by 1,000 Gallons)
On-Off Control	Set on & off control based on PV
On-Off Control with Random Varying On/Off Points	Select Randomizer, enter on/off points +/- random variation
On-Off Multi-Set	Calculate On/Off for multiple positions based on a single input and multiple set-points
Lead-Lag Control	Calculate On/Off for multiple positions based on multiple logic inputs. Inputs are True if not zero, otherwise false.
Pump Alternation	Calculate On/Off for multiple positions based on multiple logic inputs. Inputs are True if not zero, otherwise false.
Logic OR, AND, NOT	Calculate logic combinations of multiple inputs. Inputs are True if not zero, otherwise false.
Select A or B	Switch between 2 inputs
Select 1,2,3...	Select 1 from 3 or more inputs, it works as a selector switch
Schedule	Daily or weekly event The available actions depend on the configuration of the inputs and outputs.
Capture	Set a trigger event to capture a value in real time
PID Control	Set up channel for PID control
PWM Control	Set up channel for pulse width modulation control to be used with PID control loop
Switch Position	Set up channel to read the digital switch position (0, 1, 2, 3)
Relays	
Cycle Count	Number of relay cycles since reset
Runtime	Relay runtime (ON) hh:mm:ss
Modbus	
Time Since Read	Time since a Modbus client device read a register
Time Since Write	Time since a Modbus client wrote to a register

Additional Functions	Bitwise
Bitwise Constant	Configure numeric constant in Hexadecimal format.
Bitwise Hex	Convert input to Hexadecimal format.
Bit Test	Calculate True/False if a specific bit of the input is set to 1.
Bitwise OR, AND, NOT	Calculate bitwise logical combinations of multiple inputs. Resulting output is a 32-bit Hexadecimal format.
Bitwise RSH, LSH	Convert input to Hexadecimal format, then perform bit shift operation.
Bitwise Map	Convert input to Hexadecimal format, then perform a bit rearrangement based on bit to bit mapping.
Bitwise Count	Convert input to Hexadecimal format, then count the number of bits that are set to 1.
Bitwise First, Last	Convert input to Hexadecimal format. The result is with only the First (Last) bit set, clearing all other bits to zero. Optionally, the result is the position of the First (Last) bit set.

List of Engineering Units

Time	seconds, minutes, hours, days & /sec, /min, /hr, /day
Distance (Height)	cm, m, Inch, Feet, Ft-In, Yard, km, miles, custom
Volume	Gallons, GAL, L, IGAL, M3, BBL, BUSH, cuYD, cuFt, cuIn, LiBBL, BBBL, HECTl, quarts, pints, fl oz, mL, DT, M/T, MGAL, custom
Pressure	psi, Pa, bar, hPa, kPa, MPa, GPa, inH2O, cmH2O, inHg, mmHg, atm, kg/cm2, kg/m2, mbar, Mbar, Torr, mTorr, custom
Weight	grams, Oz, Lb, lb, g, kg, ounces, tons, tonnes, custom
Temperature	C, F, K, Ra
Percent	%, PCT, Percent, custom
Amps	mA, Amps, custom
Volts	V, mV, Volts, custom
Counts	Pulses, Cycles, Counts, custom
Logic	ON, OFF, OPEN, CLOSED, YES, NO, START, RUNNING, STOP, STOPPED, PUMP ON, PUMP OFF, OK, OKAY, ERROR, WARNING, custom
Custom	Enter unit's name, type, base unit, and factor.

Pump Controller

Control Modes	Channels > Control 1. On-Off control 2. Multi-Setpoint control 3. Alternation control 4. Lead-Lag control
Inputs	1. On-Off control channels 2. Digital inputs 3. Modbus inputs
Relays	Any relay can be set up for pump control. It is critical to select the corresponding position for the relay to operate correctly.
Number of Alternation Pumps	Limited only by the number of available relays
On & Off Delays	Delays can be added either in the control channels or the individual relays. The delays help to prevent turning on/off multiple pumps at the same time.
Pump Controller Panel	Use channels to monitor the state of the relays and use the screens to create a pump controller annunciator panel.
Refer to <i>Pump Controller Setup</i> on page 110 for setup of the pump controller functions.	

4-20 mA Analog Inputs

Number of Inputs	(4) Analog inputs/card (28) Analog inputs max, no other I/O
Typical Input	4-20 mA
Input Range	0-24 mA
Accuracy	±0.03% of full scale ±1 count
4-20 mA Display Value	Up to six recommended ±999,999 More digits can be used, but the stability will be affected. Increase the filter value and lower the display update rate or use rounding to get a more stable reading.
Number of PID Control Loops	(8) PID control loops can be set up with (8) analog outputs connected to SCRs. Note: (4) digital outputs can be used to control SSR (Solid State Relays). Mechanical relays can be used for slow-process PID control. Contact Tech Support if more than (8) PID loops are needed.
Transmitter Power Supply	Isolated 24 VDC @ 200 mA/input Max current: 1,600 mA (All inputs) (8) Analog Input @ 200 mA max (28) Analog Input @ 20 mA max Available on AC or DC powered units
Temperature Drift	Better than 20 ppm/°C from -40 to 60°C ambient
Filter	Window average: None, 0.5, 1, 2, 4, 8 sec IIR (Infinite Impulse Response): 16, 32 sec Glitch Filter: Discards a single sample caused by high frequency noise
Filter Bypass	0 to 100 % of full scale Filter is ignored, if the signal change is greater than bypass value
Channel Input Scale Function	Scale Linear 2-Point, Scale Multi-Point (2 to 50 points)* Scale Square Root Scale Exponent (Open Channel Flow) Scale Factor Round Horizontal Tank (Volume) Units Conversion (mA Input Reading) Percent Bargraph Text (Percent)
Channel Input Live Calibration	Each channel can be calibrated using a live calibration signal from a sensor or a calibrator.
Input Protection	Each 4-20 mA input is protected by an auto-resettable fuse, 30 VDC max. The fuse resets automatically after the fault condition is removed.
Input Impedance	125 Ω typical, including auto-resettable fuse
Hart Transparency	The controller does not interfere with existing HART communications; it displays the 4-20 mA primary variable, and it allows the HART communications to pass through without interruption. The controller is not affected if a HART communicator is connected to the loop. The controller does not display secondary HART variables.
Isolation	1500 V: Input-to-power line 500 V: Input-to-input, input-to-output All analog inputs and analog outputs are isolated from each other.
Normal Mode Rejection	100 dB at 50/60 Hz
Common Mode Rejection	90 dB at 50/60 Hz

Pulse Inputs

Number Of Inputs	(4) Pulse inputs/card (28) Pulse inputs max, no other I/O
Input Type	Active Square Wave, NPN, PNP, Reed Switch, Coil (Magnetic Pickup) Normal threshold: 1.2 V (0.8 to 3.0 V) High threshold: 2.5 V (2.0 V to 6.0 V) Coil threshold: 20 mV (Low) or 100 mV (High)
Signal Level	Active Square Wave: 0 to 30 V max Typical: 0 to 5 V Coil: 20 mVp-p to 30 Vp-p (Magnetic Pickup)
Input Impedance	Active, NPN, Reed: 10 kΩ pull-up to 5 V PNP: 10 kΩ pull-down to (S-) Coil: >2 kΩ (20 mV sensitivity), >10 kΩ (100 mV sensitivity)
Isolation	Pulse inputs are not isolated, (S-) terminal is connected to system GND
Input Protection	±36 V, non-isolated
Frequency Response & Signal Level	Active Square Wave 5 V: 0 to 100 kHz Coil (Magnetic Pickup): 0 to 50 kHz <u>Frequency – Signal level (Coil: 20 mV)</u> 20 mVp-p – 100 Hz 100 mVp-p – 10 kHz <u>Frequency – Signal level (Coil: 100 mV)</u> 100 mVp-p – 90 Hz 500 mVp-p – 5 kHz 20 Vp-p – 50 kHz
Minimum Frequency	250 μHz with High Gate = 4,000 sec
Low Gate	1 to 99 sec
High Gate	2 to 4,000 sec (Must be higher than low gate)
Low Speed	100 Hz maximum Used for contact debouncing
Pulse Counter	8,388,607 maximum, used for troubleshooting purposes only
Accuracy	±1 count for K-Factor > 1 or 30 ppm
K-Factor	Programmable pulses/unit of measure with up to 14 decimal resolution
Scale Pulse Input	Scale Linear 2-Point Scale Multi-Point Scaling*: 2 to 50 points Scale Factor Units Conversion
Live Calibration	Pulse input channel can be calibrated using live calibration signal from a sensor.

IMPORTANT

***Scale Multi-Point:** There is no minimum input span requirement; it is up to the user to make sure the input values are correct.

Modbus Inputs - Server

Availability	Standard feature
Number of Inputs	199 Modbus RTU or ASCII
Scale Modbus Input	Modbus input can be used as the input for creating channels and totals, the same way the 4-20 mA inputs are used.
Data Type	Bit-Logic Signed/Unsigned: 16 (Short), 32 (Long), 64 (Long-Long) Float 32, Float 64 (Double)
Decimal Point	User selectable
Comm Break & Timeout	Specify what value to hold when a communication break occurs and how long to wait for new data before reporting a break condition.
Input Action	Specify what should happen when new data is written to the input register (e.g. Add to Total 1, Log Entry – All Logs).

Digital Inputs

Digital Inputs	5 Inputs, non-isolated, 30 VDC max Standard feature on all ConsoliDator+ models 15-Digital Inputs Card (Optional) Low: 0 to 1.2 V High: 2.8 to 30.0 V Internal pull-up: 5 kΩ to 5 V Max pulse frequency: 1 kHz @ 5 Vp-p +5 V terminal: Internal pull-up 100 Ω Note: Pulse inputs can be used as digital inputs
Digital Input Types	Normally open switch: External excitation not required (Current: 1 mA) Open collector: 4.1 V open circuit voltage Logic level: 0 to 30 V
Assignment & Operation	Active Low or Active High Functions: Remote front panel button, total functions, timer control, alarm functions, screen navigation, horn functions, reset relay information. Digital inputs can be used as input source for channels, totals, and alarms.
Input Protection	±36 V, non-isolated

Temperature Inputs

Inputs	Thermocouple: J, K, T, E, R, S, B, N, C RTD: 100 Ω platinum (0.00385 & 0.00392 coefficients), 10 Ω copper, 120 Ω nickel, 1000 Ω platinum (0.00385 & 0.00392 coefficients)
Cold Junction Reference	Automatic, fixed, no user calibration needed
Temperature Drift	±2°C maximum from 0 to 55°C ambient temperature ±4°C maximum from -25 to 0°C ambient temperature
Input Impedance	Greater than 100 kΩ
Sensor Break Detection	Open TC or RTD sensor indicated by display break, relays can be programmed to go "On", "Off", or to "Ignore" (<i>Note: Ignore is detected as an upscale condition</i>). Analog output goes to the programmed sensor break value.

Accuracy & Ranges

Type	Range (°F)	Accuracy	Range (°C)	Accuracy
J	-200 to 2000	±1.8°F	-129 to 1093	±1°C
K	-200 to 2400	±1.8°F	-129 to 1316	±1°C
T	-200 to 752	±1.8°F	-129 to 400	±1°C
E	-200 to 1800	±1.8°F	-129 to 982	±1°C
R	-50 to 3000	±3.6°F	-46 to 1649	±2°C
S	-50 to 3000	±3.6°F	-46 to 1649	±2°C
B	752 to 3300	±3.6°F	400 to 1816	±2°C
N	-100 to 2300	±3.6°F	-73 to 1260	±2°C
C	32 to 4100	±3.6°F	0 to 2260	±2°C
10Ω	-328 to 500	±0.2°F	-200 to 260	±0.1°C
100Ω	-328 to 1562	±0.7°F	-200 to 850	±0.4°C
120Ω	-110 to 500	±0.2°F	-79 to 260	±0.1°C
1000Ω	-328 to 900	±0.7°F	-200 to 482	±0.4°C

Digital Outputs

Digital Outputs	4 Outputs Standard feature on all ConsoliDator+ models Low: 0 V (no load), 1.5 V max @ 10 mA sink (External pull-up) High: 5.0 V (no load), 3.5 V @ 10 mA load Maximum current: 30 mA Output impedance: 100 Ω Output protection: 150 mA auto-resettable fuse Max frequency: 5 Hz
Digital Output Assignment	Digital outputs require logic units as the input. Input sources: Digital input, Modbus input, channel, alarm, horn, always on, or always off
Output Protection	±36 V, non-isolated

Relays

Number of Relays	(5) Relays/card (30) Relays max with (4) analog or (4) pulse inputs, no other I/O
Rating	SPDT (Form C) Resistive load: Rated 10A @ 120/240 VAC or 8A @ 30 VDC Inductive load: NO contacts: 5A, 1/3 HP, 120 VAC; 30,000 cycles NC contacts: 1/8 HP, 120 VAC; 50,000 cycles Minimum load: 100 mA @ 5 VDC
Maximum Current per Relay & Number of Relays	11 relays or more: 5A @ 120/240 VAC or 30 VDC. Limited due to heat dissipation inside the enclosure.
Isolation	1500 VAC, 50/60 Hz for 1 min between coil and contacts
Deadband	0-100% of full scale, user selectable
Electrical Noise Suppression	TVS diodes & snubbers on all contacts. Recommended additional external snubber: 0.01 μ F/470 Ω , 250 VAC (Order: PDX6901)
Assignment & Operation	Any relay can be assigned to any alarm, channel, total, timer, digital input, Modbus input, pump control, batch control, horn, always on, or always off. Multiple relays can be assigned to the same alarm or channel. All relays are programmed independently. High & Low Alarm: Defined by set and reset points in the Alarm menu High or Low Alarm: Assign relay to any alarm or channel for on/off relay control Note: Automatic reset only for channel Multi-Source High or Low Alarm: Assign relay to multi-source alarm to indicate common high or low condition. Pulse Action: Set any relay for pulsing on/off timed relay control. Programmable pulse width (on/off time) and on/off delay. Sampling: Relay must be assigned to channel setup for Sampler function with user-defined total increment and sampling time. Pump Alternation: Any relay can set up to alternate with any relay in the group. Multiple alternation groups can set up.
Acknowledge	Front panel Ack key or digital input acknowledges individual or all alarms; relays associated with acknowledged alarm are turned off.
Alarm Relay	Assign any relay to be driven by any alarm; acknowledging the alarm turns off the relay (non-fail-safe mode).
Time Delay	Programmable on/off delays, 0.0 to 999.9 sec Independent for each relay.
Auto Initialization	When power is applied to the controller, relays will reflect the state of the input to the controller.
Fail-Safe Operation	The relay coil is energized when the process variable is within safe limits and the relay coil is de-energized when the alarm condition exists.

4-20 mA Transmitter Outputs

Number of Analog Outputs	(5) Analog outputs/card (35) Analog outputs max with no other I/O cards (Seven I/O slots)
Output Range	4.00 to 20.00 mA, nominal
Calibration	Factory calibrated for 4-20 mA
Scaling Range	Any process range Reverse scaling allowed
Assignment & Operation	Assign to any analog or pulse input, digital input, Modbus input, channel, total, timer, alarm, or fixed value (none). Note: Multiple 4-20 mA outputs can be assigned to the same input.
Accuracy	\pm 0.03% F.S. \pm 0.005 mA
Temperature Drift	20 ppm/ $^{\circ}$ C from -40 to 60 $^{\circ}$ C ambient. (Output & Input drifts are separate)
Output Loop Power	Powered by controller: 24 VDC @ 24 mA max or powered externally by 12 to 32 VDC
Output Loop Resistance	Powered by controller: 10 to 600 Ω External 12 VDC: 10 to 200 Ω External 24 VDC: 10 to 600 Ω External 32 VDC: 10 to 1000 Ω
Isolation	1500 V: Output-to-power line 500 V: Output-to-output, output-to-input All analog inputs and analog outputs are isolated from each other.

Timers

Number of Timers	Up to 30
Time Format	hh:mm:ss with 0 decimals selected Seconds with 1 or more decimals
Automatic Actions	Power Up: Timer action on power up Error: Action when an error is detected Reset: Event causes the timer to reset Start: Event triggers the timer to start Stop: Event causes the timer to stop
Start / Stop Reset	The function keys and digital inputs can be used to start, stop, and reset the timers, regardless of the automatic actions selected.
Assignment & Operation	Timers can be triggered, stop, and reset, by rising or falling signals from 4-20 mA input, pulse, digital, Modbus input, channel, total, other timers, alarm, mA output, relay, or Modbus output.
Count Down Timer	Select count down and enter starting time
Timer Alarm	Timer can be used to trigger alarms
Bargraph	Select bargraph during setup and scale the bargraph for 0 – 100% target time
Timer Control	Access timer control via the <i>View Timer</i> menu or assign a function key to timer control in the <i>Screens</i> menu
Timer & Relay	Timer can be assigned to drive relays based on selected set and reset points.

Modbus Outputs - Server

Availability	Standard feature
Data Type	Bit-Logic Signed/Unsigned: 16 (Short), 32 (Long), 64 (Long-Long) Float 32, Float 64 (Double)
Register Numbers	The register numbers are automatically generated based on the Modbus output number and the output's data type. Bit – Logic: 04101 – 04199 Signed/Unsigned 16: 44101 – 44199 Signed/Unsigned 32: 44201 – 44398 Signed/Unsigned 64: 45001 – 45396 Float 32: 44401 - 44598 Float 64: 44601 - 44996
Engineering Units	Select the engineering units for the process variable assigned to the output
Decimal Point	User selectable. For short and long integers this is a multiplier applied to the input value, but it is not displayed on the server's screen. The Modbus client uses this setting to read the correct value from the server. Example: Ch 1 value = 4,379.26 MB Output Data Type: Signed 32 Decimals = 0 → Output = 4,379 Decimals = 3 → Output = 4,379,260
Output Action	Specify what should happen when the output register is read by the client (e.g. Start timer 1, Log Entry – All Logs).

Printer Card

Part Number	PDA9000-CP
Cable Connection	DB9M - 10 ft DB9F to DB25M Null Modem Cable (Included with printer card)
Screw Terminal Connection	5.0 mm pitch (Rx, Tx, /CTS, GND) Note: Use only one of the connection methods.
Test Printing	Prints system information, including details on installed I/O cards and firmware versions.
Data Printing	Includes batch ticket printing, event logs (such as alarms and time), and other critical data.
Text Formatting	Allows up to 24 text entries with four tab settings for aligning different items on the same line.
Printer Functions	Allows for printing of a custom ticket using data pulled from various sources (such as channels, inputs, outputs, etc). Tickets can be printed manually using function keys or digital inputs, as well as automatically via programmed trigger events.

Notes:

1. Printer card output uses an RS-232 serial connection.
2. ConsoliDator+ models equipped with a printer card are not UL Listed.
3. Printer card occupies one I/O slot.

Modbus Serial Communications

Compatibility	RS-485 (EIA-485)
Protocols	Modbus RTU or Modbus ASCII Modbus Enron is supported by the Client and the Spoofer modes.
Device Address	1 to 247 (Server)
Transmit Delay	0 to 999 ms
Receive Timeout	1 to 9 seconds
Baud Rate	1,200 to 115,200 bps
Data	8 bit (1 start bit, 1 stop bit)
Parity	Even, Odd, None with 1 stop bit, or None with 2 stop bits
Modbus Inputs	199 for all modes
Modbus Outputs	99 for all modes. The outputs can be grouped together to be sent as blocks of registers. These Modbus outputs are in addition to the outputs listed in the <i>Modbus Register Tables</i> , see page 163.
Communication Break	Reports a break condition after the response timeout has elapsed. The break condition can be: Zero, a default value, or the text Break. The Client goes into break condition after the server device fails to respond and the timeout has elapsed. The Snooper and Server modes go into break condition after no new data is received within the response timeout window. Alarms can be programmed to go on, off, or stay as is when a break condition is detected. The analog outputs can set up to generate a fixed mA current when a break condition is detected.

Modbus Client, Snooper & Spoofer

Add-On Feature PDK9000-M1	The Modbus Client, Snooper & Spoofer Add-On Feature is an option in the ConsoliDator+. It can be purchased at the time the order is placed, or it can be purchased and enabled at any time. (Cons+ firmware version 2.1 or greater) See <i>How to Enable Add-On Features</i> on page 139.
Modes	Client: Requests data from servers and writes data to servers. Snooper: Listens to the RS-485 network communications and reads the selected registers. Spooper: A channel is configured to pretend being a device that has been removed from the network. The device ID and register number is used.

Client & Snooper Settings

Availability	Order Add-On Feature model PDK9000-M1 at any time. (Cons+ firmware version 2.1 or greater) See <i>How to Enable Add-On Features</i> on page 139.
Number of Output PVs	99 process variables can be written by the Client mode to Modbus servers. Modbus server inputs and outputs are available over the Ethernet port, in Client mode also.
Server ID	Enter the server ID or address containing the process variables to be read or written by the Client or read by the Snooper.
Function Code	Select which Modbus function code to use for reading the server device or for writing to a server by the ConsoliDator+ Client.
Register Address	0-65,533 (Base 0) Reg. No. 30001-39999, 40001-49999 Reg. No. 300001-365534 or 400001-465534 Specifies which register(s) to read from the server device.
Data Type	Select the data format used by the server device. Bit – Logic (Coil) Signed/Unsigned: 16 (Short, 2 byte) 32 (Long, 4 byte) 64 (Long Long, 8 byte) Float 32 (4 byte), Float 64 (Double, 8 byte)
Byte Order	ABCD, CDAB, BADC, or DCBA (big-endian, swapped, or little-endian)
Client Poll Time	1.0 to 999.9 sec. Time between read commands.
Server Response Timeout	99:59:59 hrs.: Time allowed for the server to respond before the Modbus client generates a communication break condition. The timeout should be greater than the poll time. Server/Snooper mode: Time the Modbus input will wait for new data before going into a break condition. If the timeout is disabled, the last value will remain until a new value is received.

Spoofers Settings

Availability	Order Add-On Feature model PDK9000-M1 at any time. (Cons+ firmware version 2.1 or greater) See <i>How to Enable Add-On Features</i> on page 139.
Number of Output PVs	99 process variables can be replaced by the ConsoliDator+ Spoofer feature.
Number of Input PVs	199 process variables can be written by a client to the Spoofer inputs replacing other Modbus servers.
Server ID	Enter the server ID or address being replaced by the ConsoliDator+ Spoofer.
Function Code	Select the Modbus function code used by the server device.
Register Address	Enter the address 0-65,533 (Base 0) for the process variable of the replaced server.
Data Type	Select the data format used by the server.
Byte Order	Select the byte order ABCD, CDAB, BADC, or DCBA (big-endian, swapped, or little-endian)
Engineering Units	Select the engineering units for the process variable.
Decimals	Enter the number of decimals required.
Output Action	Select an action to be performed by the controller, when the Spoofer output is read by a Modbus client or leave as None.

Data Logger – USB Drive

USB Data Logger Add-On Feature PDK9000-D1	The Data Logger Add-On Feature is an option in the ConsoliDator+. It can be purchased at the time the order is placed, or it can be purchased and enabled at any time. (Cons+ firmware version 2.2 or greater) See <i>How to Enable Add-On Features</i> on page 139.
Storage Device	External USB flash drive Format: FAT32 (32 GB maximum) Recommended drive: SanDisk 32GB maximum.
Number of Data Logs	8, maximum
Number of Variables / Log	12, maximum
Number of Log Variables	96 variables, maximum (8 logs x 12 variables / log)
Number of Log Records	The number of records depends on the flash drive size. Examples for 32 GB: 1) 4 logs with 8 variables each 1 min rate: ~160,000,000 records Log time: 60 years 2) 8 logs with 12 variables each 1 min rate: ~70,000,000 records Log time: 16 years
Log File Type	csv (comma separated value)
Maximum Log File Size	100 MB A new file is automatically created when the log file exceeds 100 MB.
Stop when Full	This should be selected if the oldest logged data is more important than logging new data. If <i>Stop when Full</i> is not selected, the oldest block of data will be deleted to make room for new data.
Remove Device	Use the <i>Remove Device</i> button, in the <i>System – USB Drive</i> , to safely remove the USB drive and prevent data corruption.
Alert! Message	An Alert! message is displayed in place of the Menu key if the USB drive is removed.
Start / Stop	Selecting this feature enables the <i>Start / Stop</i> function key in the <i>View – Data Logs</i> menu. The <i>Start / Stop</i> function can be activated using the digital inputs, F1-F4 function keys in the <i>Setup – Screens</i> menu, Channel control schedule, Modbus inputs, and Modbus outputs.
Log Enable Switch	The <i>Enable Switch</i> setting can be used to control the log process using digital inputs, Modbus inputs, Channel control, alarms, or relay outputs. Logs are recorded only if the <i>Enable Switch</i> input is in the active (on) condition.
Log Trigger	The <i>Log Trigger</i> setting is used to log data on a specific event; a log can be triggered using digital inputs, Modbus inputs, Channel control, alarms, relays.
Manual Log	The user can record a log entry at any time by using the F4 key in the <i>View – Logs</i> menu or by assigning a function key in the <i>Setup – Screens</i> menu.
Log Interval	00:00:01 to 23:59:59 hrs:min:sec

How to Enable Add-On Features

To enable the Data Logger features, see *How to Enable Add-On Features* on page 139.

IMPORTANT

- The USB Data Logger functions are available only if the Add-On feature has been enabled in the System – General Settings, see *How to Enable Add-On Features* on page 139.

Sample Data Log File

Device Tag: Multivariable Controller									
Log Name: Tank Farm Log									
Date	Time	T1. Tank 1	T1. Units	T2. Tank 2	T2. Units	T3. Tank 3	T3. Units	T4. Tank 4	T4. Units
4/8/2021	7:41:07	109690	Gallons	99690	Gallons	89690	Gallons	79690	Gallons
4/8/2021	7:41:10	109691	Gallons	99691	Gallons	89691	Gallons	79691	Gallons
4/8/2021	7:41:11	109692	Gallons	99692	Gallons	89692	Gallons	79692	Gallons
4/8/2021	7:41:12	109693	Gallons	99693	Gallons	89693	Gallons	79693	Gallons
4/8/2021	7:41:13	109694	Gallons	99694	Gallons	89694	Gallons	79694	Gallons
4/8/2021	7:41:14	109695	Gallons	99695	Gallons	89695	Gallons	79695	Gallons
4/8/2021	7:41:15	109696	Gallons	99696	Gallons	89696	Gallons	79696	Gallons
4/8/2021	7:41:16	109697	Gallons	99697	Gallons	89697	Gallons	79697	Gallons
4/8/2021	7:41:17	109698	Gallons	99698	Gallons	89698	Gallons	79698	Gallons
4/8/2021	7:41:18	109699	Gallons	99699	Gallons	89699	Gallons	79699	Gallons
4/8/2021	7:41:19	109700	Gallons	99700	Gallons	89700	Gallons	79700	Gallons
4/8/2021	7:41:20	109701	Gallons	99701	Gallons	89701	Gallons	79701	Gallons
4/8/2021	7:41:21	109702	Gallons	99702	Gallons	89702	Gallons	79702	Gallons
4/8/2021	7:41:22	109703	Gallons	99703	Gallons	89703	Gallons	79703	Gallons
4/8/2021	7:41:23	109704	Gallons	99704	Gallons	89704	Gallons	79704	Gallons
4/8/2021	7:41:24	109705	Gallons	99705	Gallons	89705	Gallons	79705	Gallons
4/8/2021	7:41:25	109706	Gallons	99706	Gallons	89706	Gallons	79706	Gallons
4/8/2021	7:41:26	109707	Gallons	99707	Gallons	89707	Gallons	79707	Gallons
4/8/2021	7:41:27	109708	Gallons	99708	Gallons	89708	Gallons	79708	Gallons
4/8/2021	7:41:28	109709	Gallons	99709	Gallons	89709	Gallons	79709	Gallons
4/8/2021	7:41:29	109710	Gallons	99710	Gallons	89710	Gallons	79710	Gallons
4/8/2021	7:41:30	109711	Gallons	99711	Gallons	89711	Gallons	79711	Gallons
4/8/2021	7:41:31	109712	Gallons	99712	Gallons	89712	Gallons	79712	Gallons
4/8/2021	7:41:32	109713	Gallons	99713	Gallons	89713	Gallons	79713	Gallons
4/8/2021	7:41:33	109714	Gallons	99714	Gallons	89714	Gallons	79714	Gallons

Ethernet Communications

Device	Lantronix Xport-05
Protocol	Modbus TCP/IP (Default) Modbus UDP/IP Modbus RTU Over TCP/IP Modbus RTU Over UDP/IP
Port Settings (Do Not Change)	Protocol: RS-232 Baud Rate: 9600 Data Bits: 8 Flow Control: None Parity: None, Stop Bits: 1
Network Stack	IPv4
Ethernet Mac/Phy	10/100 Mbps
Additional Specifications	Refer to the Lantronix webpage at https://www.lantronix.com/products/xport .
Ethernet Port Configuration	Use the <i>System</i> menu for basic Ethernet configuration or download the Lantronix Device Installer software to fully configure the Ethernet port at https://www.lantronix.com/products/xport . See page 146 <i>Ethernet Port Setup</i> for instructions.

ConsoliDator+ Software

System Requirements Windows® 7, 10

Compatibility The software and firmware versions must be matched.

CAUTION

- Do not write configuration files created using older versions of the firmware and software to controllers with Add-On features enabled (Ver. 2.1 & up). This can create undesirable results, especially with the function keys F1-F4.

Connection Standard USB A to Micro-USB type B (cable included).

Configuration Configure inputs and outputs, channels, totals, timers, alarms, etc.
Configure bargraph and panel colors for normal operation, and colors for alarm indication. Save controller settings file on PC for programming other controllers or to restore settings.

Note: The ConsoliDator+ software version must be used with the corresponding firmware version (e.g. Software v2.2 & Firmware v2.2)

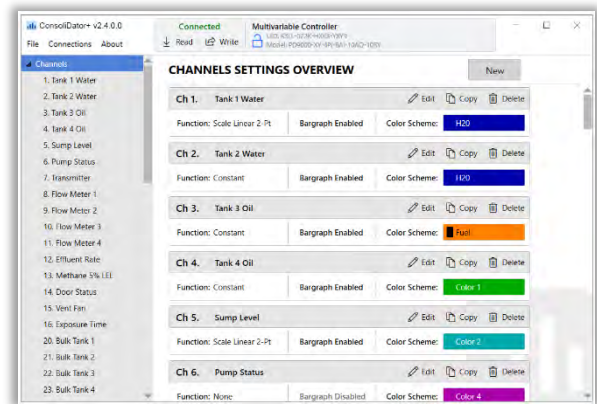

Compliance Information

Hazardous Area Location*

UL & C-UL Listed	For Hazardous Location Installations (US and Canada) Class I Division 2 Groups A, B, C, and D Class II Division 2 Groups F and G Class III Temperature Code: T4A
UL File Number	E516990
Front Panel	UL Type 4X, NEMA 4X, IP66; Panel gasket provided
Low Voltage Directive	CSA-C22.2 No. 61010-1 and CSA-C22.2 No. 61010-2-201 UL 61010-1 and UL 61010-2-201 Safety Requirements for Electrical Equipment for Measurement, Control, and Laboratory Use

WARNINGS

- Explosion Hazard - Batteries must only be changed in an area known to be non-hazardous.
- Explosion Hazard - Do NOT Connect or Disconnect Equipment unless power has been switched off or the area is known to be non-hazardous.

*Hazardous Area Location approvals apply to all PD9000 (H) models. See ordering information.

Note: Models with -TI (Temperature Inputs Card), -DI (Digital Inputs Card), and -P (Printer Card) installed are not UL & C-UL Listed.

Ordinary Location*

UL & C-UL Listed	USA and Canada UL 508 Industrial Control Equipment
UL File Number	E160849
Front Panel	UL Type 4X, NEMA 4X, IP66; Panel gasket provided
Low Voltage Directive	CSA-C22.2 No. 61010-1 and CSA-C22.2 No. 61010-2-201 UL 61010-1 and UL 61010-2-201 Safety Requirements for Electrical Equipment for Measurement, Control, and Laboratory Use

*Ordinary Location approvals apply to all PD9000 (G) models. See ordering information.

Note: Models with -TI (Temperature Inputs Card), -DI (Digital Inputs Card), and -P (Printer Card) installed are not UL & C-UL Listed.

Safety Information

CAUTION

- Read complete instructions prior to installation and operation of the controller.

WARNINGS

- Risk of electric shock.
- Hazardous voltages exist within enclosure.
- Installation and service should be performed only by trained service personnel.

Installation

Unpacking

Remove the instrument from its box. Inspect the packaging and contents for damage. Report any damages to the carrier. If any part is missing or the controller malfunctions, please contact your supplier or the factory for assistance.

Panel Mounting

- Prepare panel cutout per the dimensions provided
- Locate the panel mounting bracket and screws
- Inspect the controller to assure the gasket is securely in place
- Insert controller in the panel cutout, the latches on the top and bottom should hold it in place
- Insert the panel mounting bracket from the back of the panel, observe the orientation of the piece marked TOP
- Install the 12 screws provided to a torque value of 0.8 Nm (7 lb-in)

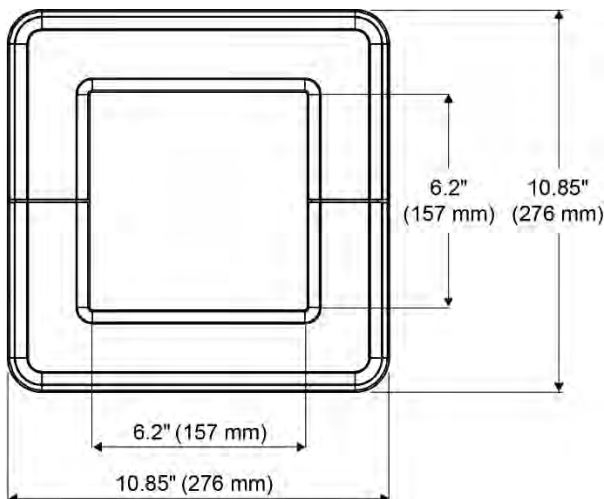

Figure 1. Front Panel Mount Dimensions

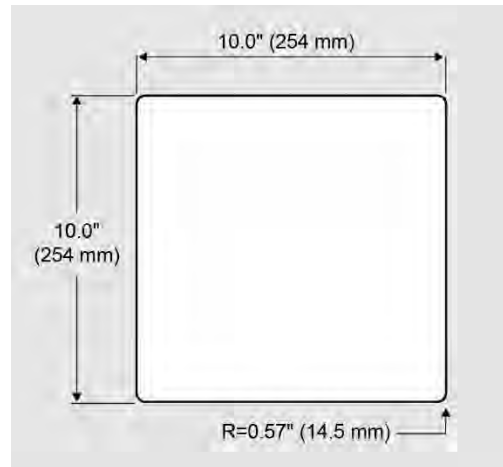

Figure 2. Panel Cutout Dimensions

Replacement Battery for Real Time Clock



Main MCU Board Showing Battery Location

WARNINGS

- Explosion Hazard - Batteries must only be changed in an area known to be non-hazardous.

- Step 1:** Remove power to the ConsoliDator+, as well as all terminal plugs that are installed.
- Step 2:** Remove 8 screws from the back of the ConsoliDator+ housing using a Phillips head screwdriver. Remove the backplate and set aside.
- Step 3:** Grabbing both ends of the board, remove Main MCU board by pulling upwards.
- Step 4:** Remove CR2032 battery and replace only with a Panasonic CR2032 Lithium Metal 3V coin cell battery.
- Step 5:** Re-insert Main MCU board, making sure to note the orientation of the three pin headers. The board should fit snugly in place and be the same height as the other installed boards.
- Step 6:** Place the backplate back onto the rear of the ConsoliDator+ and replace the 8 screws, taking care not to overtighten.
- Step 7:** Replace terminal plugs and power on unit.

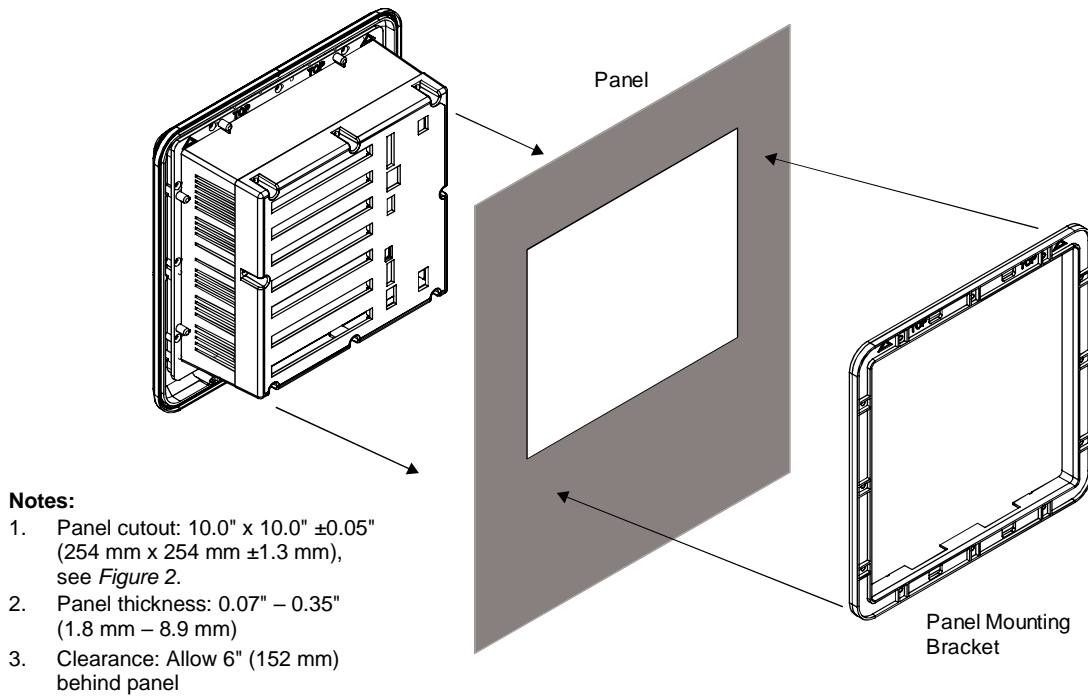

Figure 3. Panel Mount Installation

Mounting Dimensions

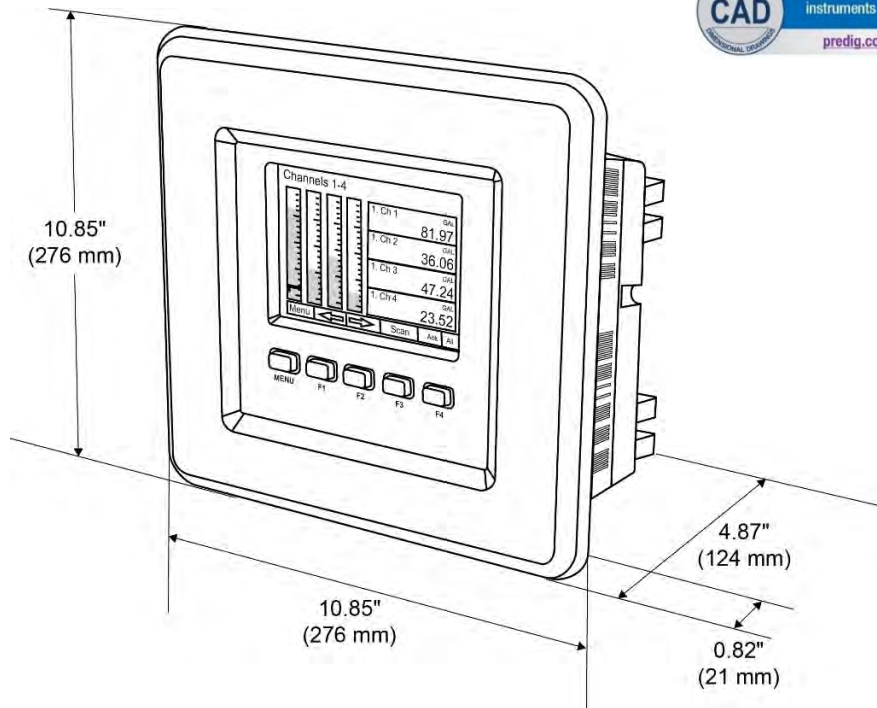
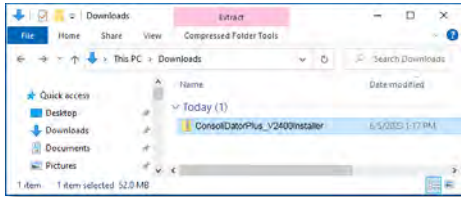

Figure 4. Panel Mount Overall Dimension

ConsoliDator+ Configuration Software Installation

We recommend the following sequence for getting the controller into service:

1. Download the latest version of the ConsoliDator+ configuration software from our website predig.com/software.
2. Extract the contents of the *ConsoliDatorPlus2XXX_Installer.zip* file into a folder on your computer.



3. Double-click on the executable file *ConsoliDatorPlus2XXX_Installer.exe* and follow the on-screen instructions.

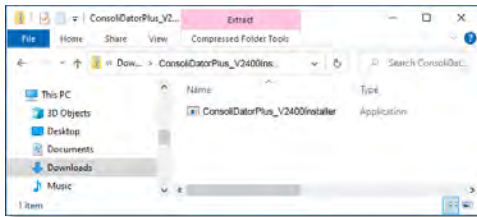

4. This message is displayed. Click on *Next* to start the setup process.

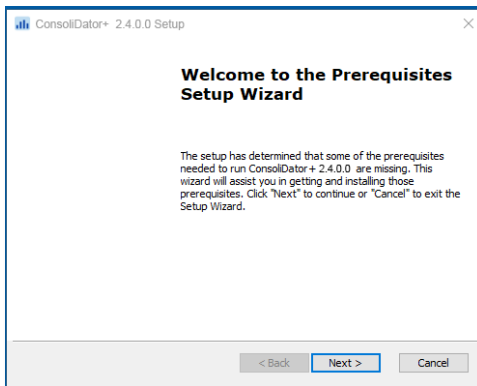

5. Follow the onscreen instructions to install the required .NET Runtime version, if not installed in your computer.

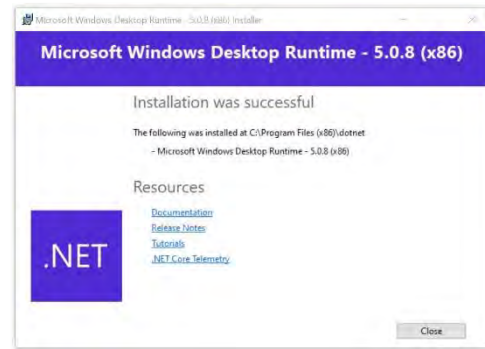
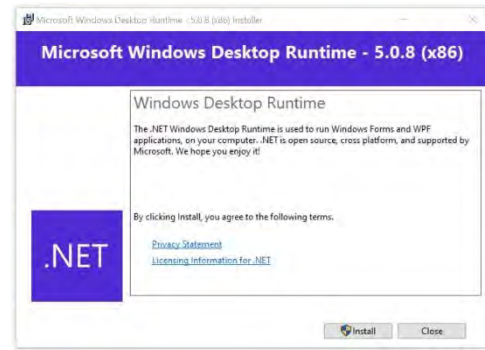
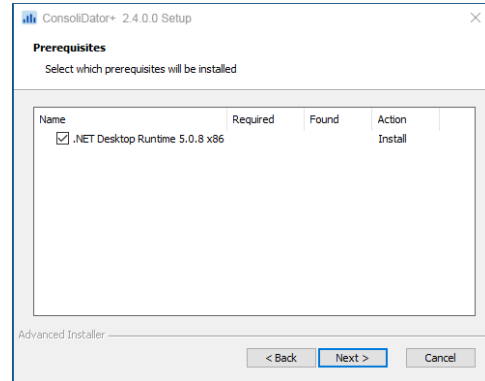

6. This message is displayed, click *Next* to continue.

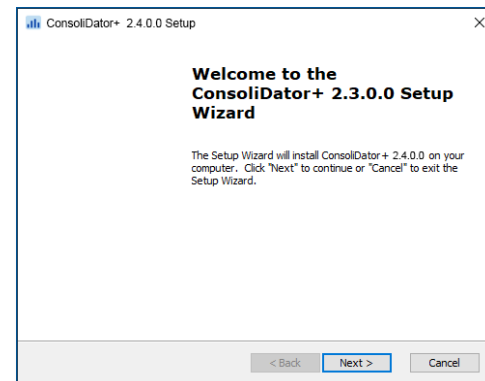

7. Read and accept the End-User License Agreement and click *Next* to proceed.

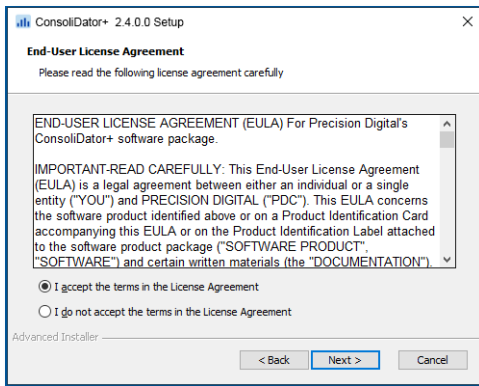

8. Select the folder where you want to install the ConsoliDator+ software and click *Next*.

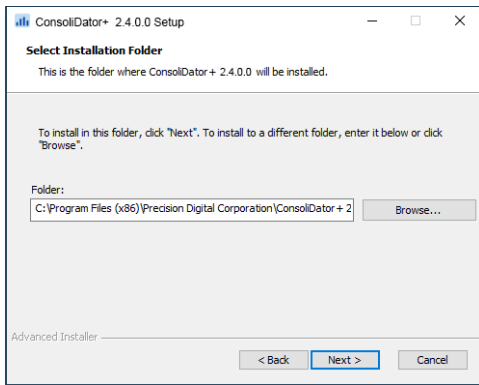

9. After selecting the installation folder, click *Install* to continue.

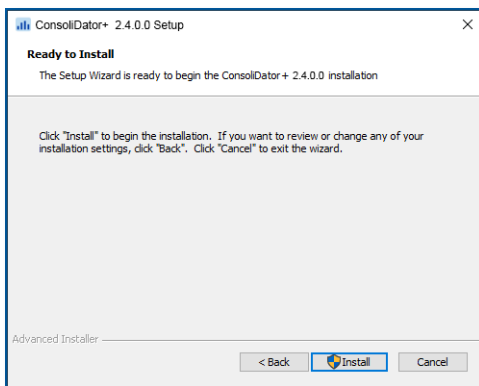

10. The User Account Control message is displayed. Click **Yes** to proceed with the installation of the ConsoliDator+ software. Follow the onscreen instructions.



11. After the software installation is complete, click the *Finish* button.

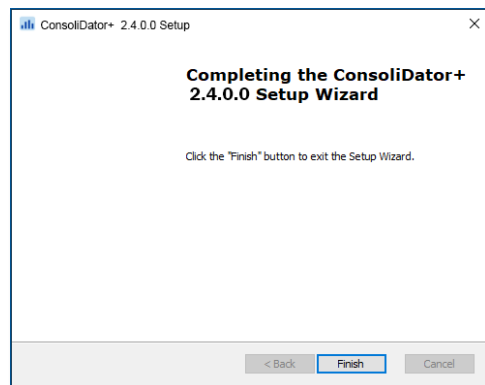

12. A ConsoliDator+ icon is placed on your desktop.

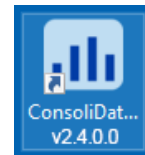

You are now ready to start using the software to configure your ConsoliDator+ controller.

The easiest and quickest way to program your ConsoliDator+ is to use the FREE ConsoliDator+ configuration software available for download at predig.com/software.

The ConsoliDator+ configuration software is intuitive, and most customers can get their controller programmed as they like without even looking in the manual.

⚠ WARNINGS

- Only one controller can be connected at a time. Attaching multiple controllers will cause a conflict with the controller software.

Connect to ConsoliDator+ Configuration Software

1. Connect one end of the provided USB cable to the controller and the other end to the computer.
2. Double-click on the ConsoliDator icon

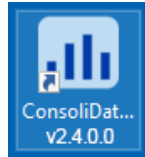

3. The application will start displaying the System menu and the connection status.

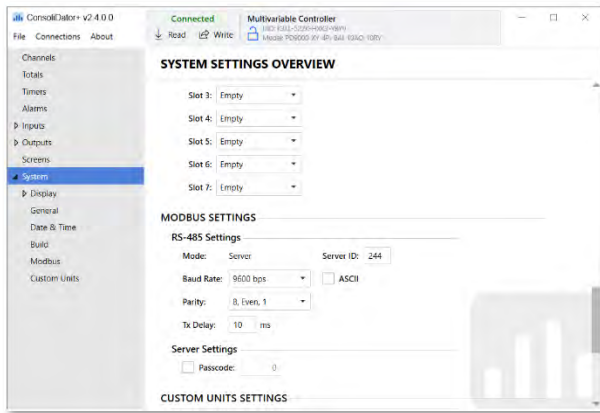

4. Click on *Read*, at the top of the screen, to read the configuration of the connected controller. After a read, the channels settings overview is displayed.

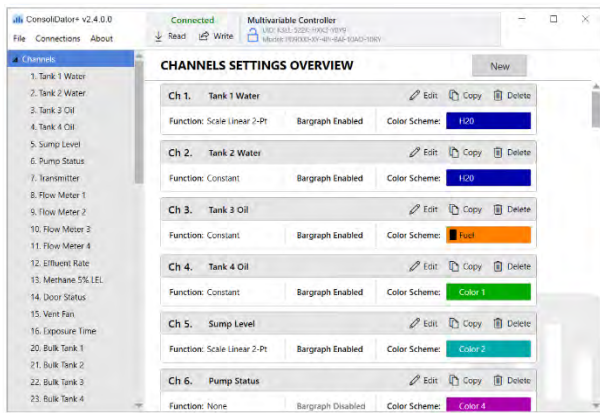

5. You can now begin to configure the ConsoliDator+ for your application, either by editing the existing settings or by starting fresh creating a new configuration.

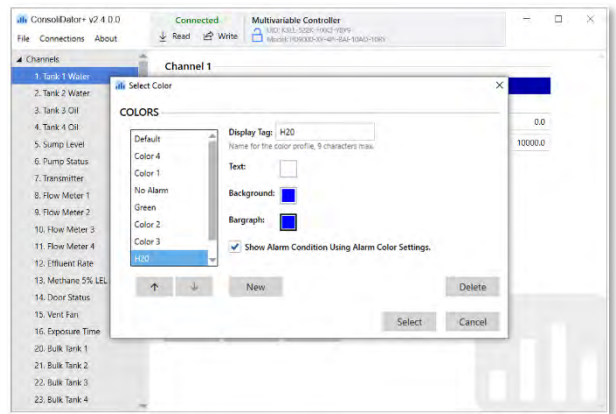
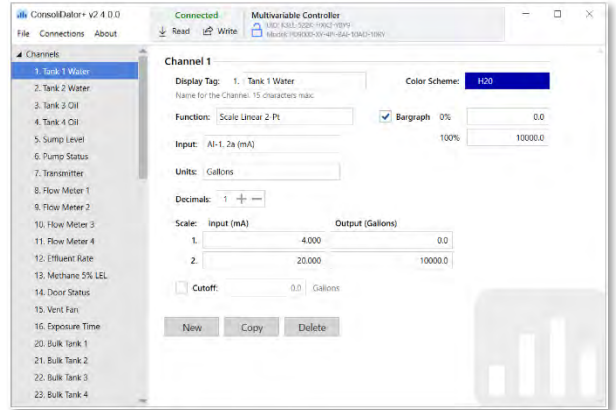

6. Click on *Write* to send the new configuration to the connected controller.
7. Click on *File* to save files, open existing files, or to create a new configuration even without a controller connected.
8. The Advanced Settings menu allows changing the target firmware version and add-on features. These settings are set automatically to match your ConsoliDator when the controller is read.

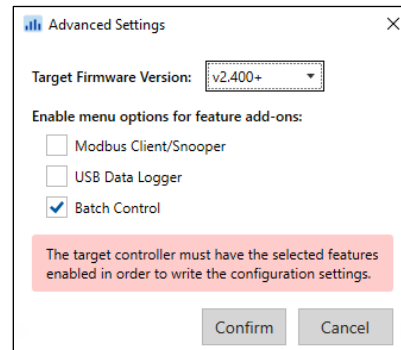

Connections

The back panel is labeled with the I/O boards that were installed at the factory. The removable connectors are labeled with the connection signal for each terminal. The following diagram shows what the back of the model PD9000-6N-4PI-4AI-4TI-5AO-5RY-15DI-E-P looks like. This model is powered from 90-264 VAC, accepts (4) pulse, (4) analog and (4) temperature inputs and has (5) 4-20 mA outputs (5) relays and (15) additional digital inputs. (5) digital inputs, (4) digital outputs, RS-485 serial capability and USB connections are standard on all ConsoliDator+ models. Ethernet is an option.

If all Input/Output slots are used exclusively for one function, the ConsoliDator+ can accept up to (28) isolated 4-20 mA inputs, (28) pulse (28) temperature inputs, (25) isolated 4-20 mA outputs, (25) relays or (105) digital inputs.

If used as a Modbus Client, Snooper, or Server only: It can have up to (35) 4-20 mA outputs or (30) relays (the top slot cannot be used for relays.)

Units are powered from AC or DC according to the power option ordered (AC: -6 or DC: -7).

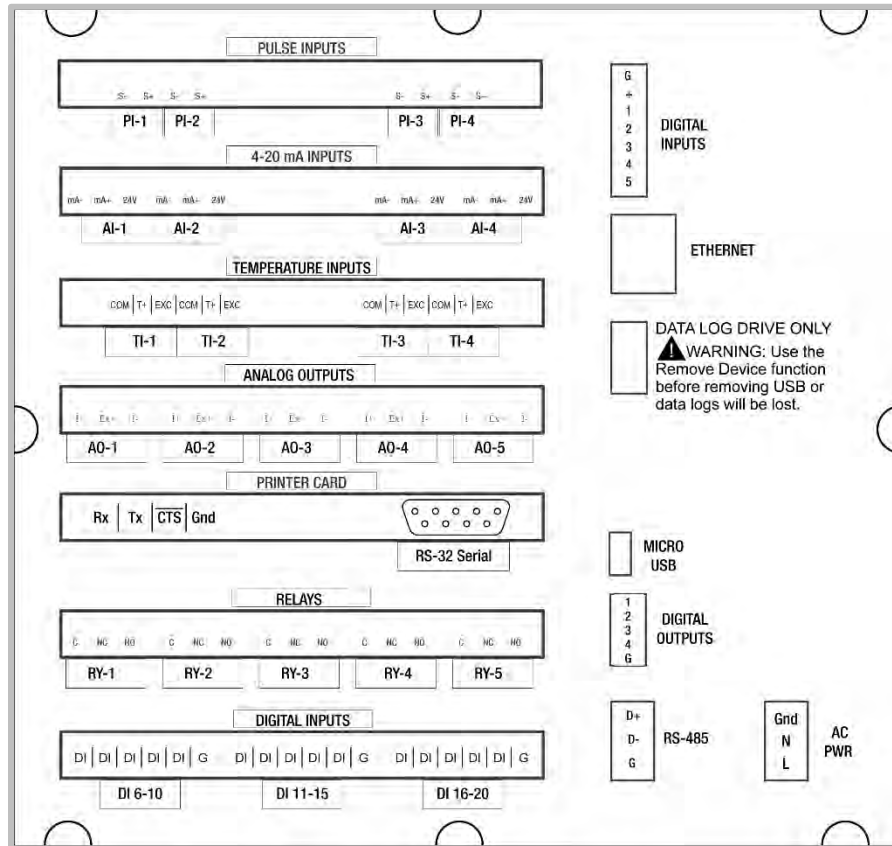

Figure 5. Connection Terminals for a PD9000-6N-4PI-4AI-4TI-5AO-5RY-15DI-E-P

Notes:

1. Each 4-20 mA input has its own isolated 24 VDC power supply to power the transmitter.
2. Each 4-20 mA output has its own isolated 24 VDC power supply to power the output loop.
3. Each relay is Form C and rated at 10 A.
4. Input / output connections are made to removable screw connectors.
5. Every ConsoliDator+ has five digital inputs standard (additional digital inputs can be obtained by using the 15-Digital Inputs card).
6. Temperature Inputs card has (4) thermocouple/RTD inputs.
7. Every ConsoliDator+ has four digital outputs.
8. Every ConsoliDator+ has RS-485 with Modbus.
9. Powered from AC or DC, depending on the ordered power option.
10. The Data Log Drive is used for the Data Logger Add-On feature.
11. Ethernet with Modbus TCP is an option.
12. Micro USB is used for programming the ConsoliDator+ with Free Software.

CAUTION

- Use copper wire with 60°C or 60/75°C insulation for all line voltage connections. Observe all safety regulations. Electrical wiring should be performed in accordance with all applicable national, state, and local codes to prevent damage to the controller and ensure personnel safety.

Power Connections

Power connections are made to a three-terminal connector for AC (-6) models and to a two-terminal connector for DC (-7) models.

90-264 VAC Power

- Use three-terminal power connector as shown in Figure 7.
- Unit is protected internally with 1.25 A auto-resettable fuse. 2 A max, slow blow, 250 V min, UL Recognized external fuse recommended.

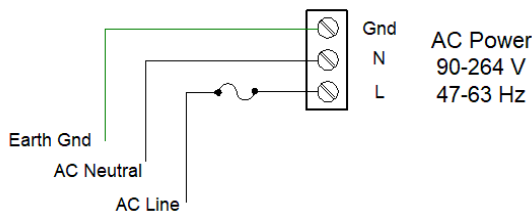

Figure 6. AC Power Connections

24 VDC Power ± 10%

- Use two-terminal power connector as shown in Figure 7.
- Unit is protected internally with 3.7 A auto-resettable fuse. 4 A max, slow blow, 50 V min, UL Recognized external fuse recommended.

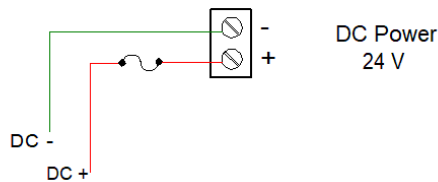

Figure 7. DC Power Connections

Isolated Input Signal Connections

Isolated input signal connections are made to removable screw terminal connectors, which are labeled individually on the back panel of the controller. The back panel shows the type of input card installed in each slot (The top slot is #1 and the bottom is #7). Individual inputs are referenced as PI-1 to PI-4 for pulse inputs and AI-1 to AI-4, AI-5 to AI-8, etc for analog inputs.

4-20 mA Analog Input Connections

Analog 4-20 Input connections are made to screw terminal connectors (two inputs per connector). The following figures show examples for typical applications. Each of the 4-20 mA inputs can be connected in any of the modes shown below.

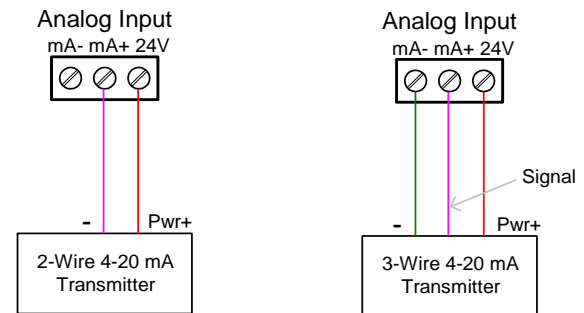

Figure 8. Transmitters Powered by ConsoliDator+ Isolated 24 VDC Power Supply

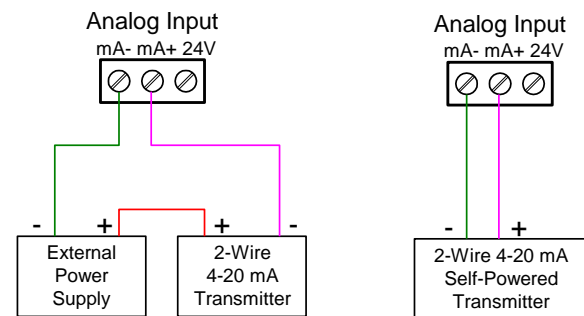

Figure 9. Transmitter Powered by External Supply or Self-Powered

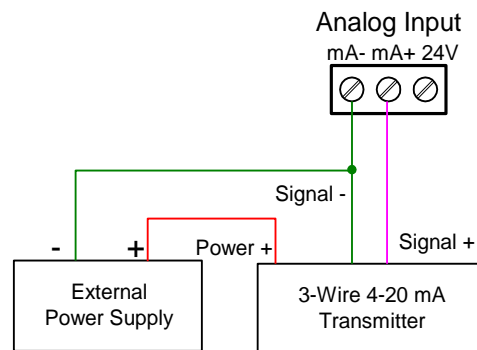

Figure 10. 3-Wire Transmitters Powered Externally

Temperature Input Connections

Temperature Input connections are made to screw terminal connectors (two inputs per connector). The following figures show examples for thermocouple and RTD connections.

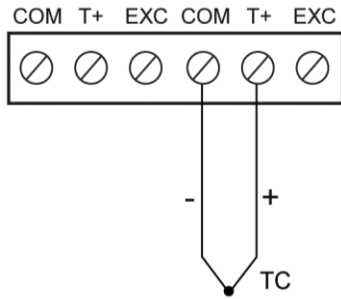

Figure 11. Thermocouple Input Connections

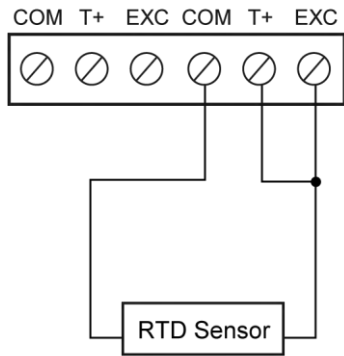

Figure 12. Two-Wire RTD Input Connections

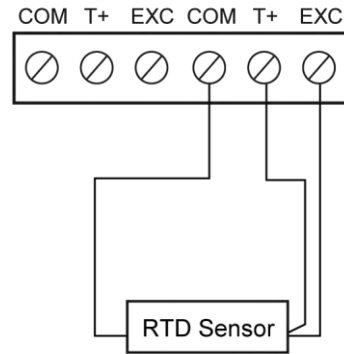

Figure 13. Three-Wire RTD Input Connections

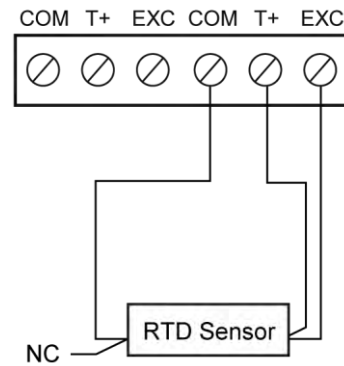

Figure 14. Four-Wire RTD Input Connections

Flow Meter Pulse Input Connections

Flow Meter Pulse Inputs are wired to four-terminal connectors (two inputs per connector). A square waveform is used in the illustration, but the pulse input can read many types of signals within the specified voltage and frequency ranges.

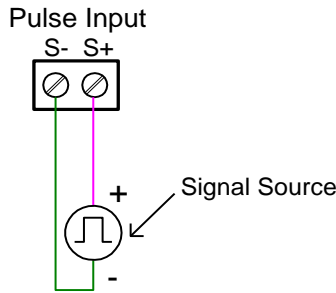

Figure 15. Flow Meter Pulse Input Connections

Digital Input Connections

Five digital inputs are available as a standard feature on the PD9000 and up to seven 15-input digital input cards may be ordered for additional inputs. The five standard digital inputs are wired between terminals 1-5 of the digital input connector and the G terminal of the 2-position connector above the digital inputs. Normally open switch contacts can be used as shown in Figure 16. The diagram also shows a Digital Input using an NPN open collector transistor output from a live signal. Logic LO or switch closure appearing across the terminals is interpreted as ON. When using an open collector transistor, a logic HI at the base (marked "B" in Figure 16) will be interpreted as ON. The 2-position connector has a +5 V terminal that can be used to provide excitation to some sensors requiring more than the pull-up provided on each digital input terminal.

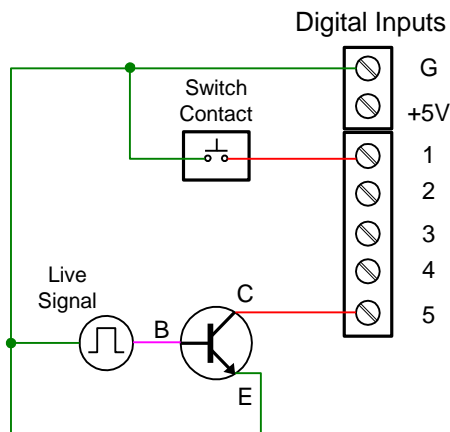

Figure 16. Digital Input from Switch Closure and Live Signal

Analog Output Connections

The following figures show examples for isolated 4-20 mA transmitter output connections. Terminal connectors are labeled individually. The analog outputs are isolated from each other and from the inputs. They are powered internally to provide an active 4-20 mA output loop. The outputs can be powered externally by connecting the positive voltage to the Ex+ terminal.

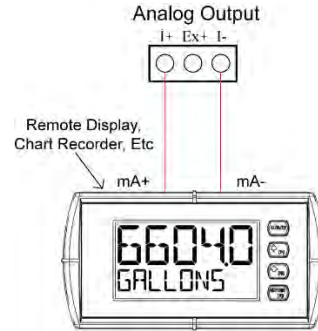

Figure 17. Active 4-20 mA Output Powered by Controller

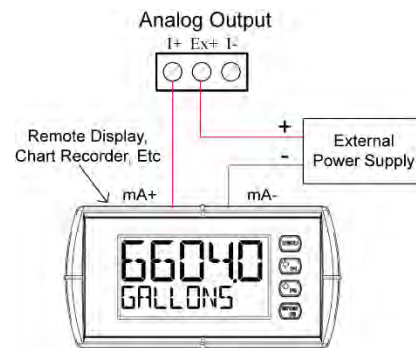

Figure 18. Passive 4-20 mA Output Powered by External Supply

Note: Analog inputs and outputs are isolated from each other.

Digital Output Connections

The digital outputs can be used to drive digital inputs, alarm annunciators, or other devices such as solid-state relays that can be driven with low voltage signals.

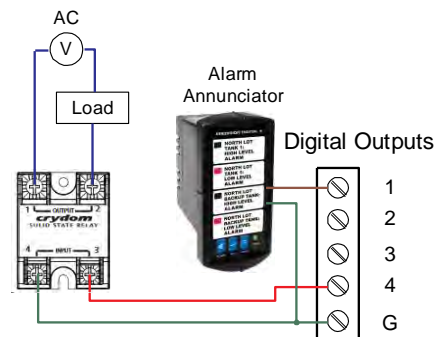

Figure 19. Digital Outputs Driving 5 V Solid State Relay

Connections to Power Gas Detector

Some sensors requiring more than 200 mA of excitation current can be powered by the ConsoliDator+ by connecting two or more power supplies in parallel as shown in the following diagrams.

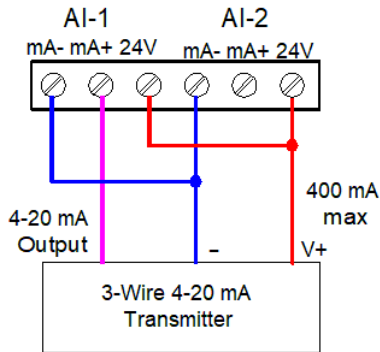

Figure 20. Two Supplies in Parallel Powering 3-Wire Transmitter

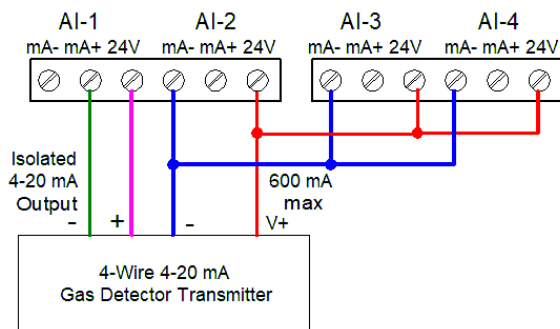

Figure 21. Powering 4-Wire Gas Detector & Isolated 4-20 mA Output

PDA9000-CP Printer Card Connection

The ConsoliDator+ can be equipped with the PDA9000-CP printer card, which installs into any available slot. With a printer card installed, the number of additional I/O cards that can be added is reduced to six. The printer easily connects to the PD9000 with the included DB9M cable.

Note: ConsoliDator+ models equipped with a printer card are not UL Listed, and the printer card occupies one I/O slot.

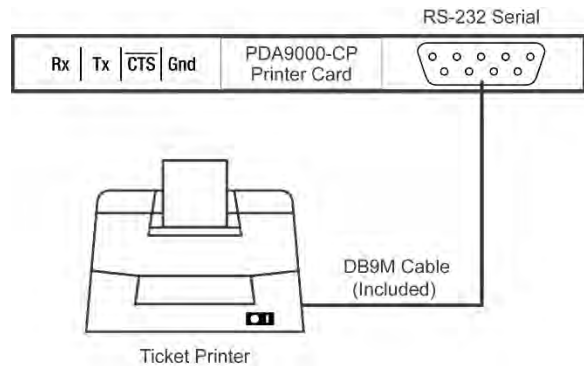

Figure 22. Printer Connections

Relay Connections

Relay connections are made to three-terminal connectors labeled individually. There are five relays per card.

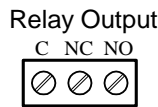

Figure 23. Relay Connections

Switching Inductive Loads

The ConsoliDator+ has an internal circuitry to protect the relays from inductive loads, however, the use of external suppressors (snubbers) is strongly recommended when switching inductive loads to prevent disrupting the microprocessor's operation. The suppressors also prolong the life of relay contacts. Suppression can be obtained with resistor-capacitor (RC) networks assembled by the user or purchased as complete assemblies. Refer to the following circuits for RC network assembly and installation.

Note: Because of the built-in RC network, there is the potential for leakage current when driving low power devices such as LEDs or piezoelectric alarms. It is recommended to use external relays to drive the low power devices or request a modification to the relay card from the factory.

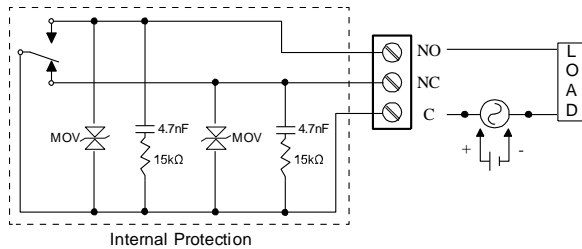

Figure 24. AC and DC Internal Inductive Loads Protection

For additional external protection choose R and C as follows:

- R: 0.5 to 1 Ω for each volt across the contacts
- C: 0.5 to 1 μF for each amp through closed contacts

Notes:

1. Use capacitors rated for 250 VAC.
2. RC networks may affect load release time of solenoid loads. Check to confirm proper operation.
3. Install the RC network at the instrument's relay screw terminals. An RC network may also be installed across the load. Experiment for best results.

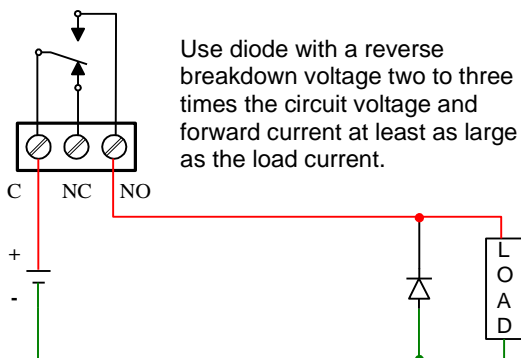

Figure 25. Low Voltage DC Loads Protection

RC Networks Available from Precision Digital

RC networks are available from Precision Digital and should be applied to each relay contact switching an inductive load. Part number: PDX6901.

Serial Communication Connections

The RS-485 port for serial communication (using Modbus protocol) has three terminals labeled D+, D-, and G. It is strongly recommended to use a three-wire shielded cable and to always connect the ground terminal to the other equipment's ground to avoid differential voltage between the systems. Distances up to 4000 feet can be reached with RS-485. Up to 32 Modbus devices can be connected to a single RS-485 bus.

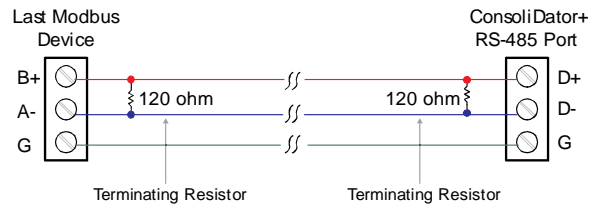

Figure 26. Serial Connections

Ethernet Option

The Ethernet port is available on the RJ45 connector. This allows the ConsoliDator+ to connect to a local area network.

The Ethernet port option is configured using the System menu. See page 27 for specifications, page 144 for setup using the ConsoliDator+ software, and page 146 for complete *Ethernet Port Setup*.

External Keypad Connections

Normally open pushbuttons can be wired to the digital inputs connector for use when the front panel of the controller is not accessible. The external keys can be assigned to replicate the Menu and F1-F4 function keys.

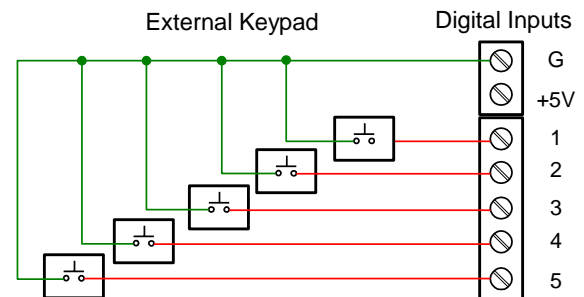

Figure 27. External Keypad Connections

Navigating and Editing

The device displays various screens throughout programming and operation. Functions are programmed within their respective menu screens and in many cases are accompanied by user prompts.

Soft-Keys and Buttons

The unit is equipped with five buttons located below the display. The function of each button corresponds to its soft-key, which appears at the bottom of the screen. Buttons assume different functions, which change according to the screen in view.

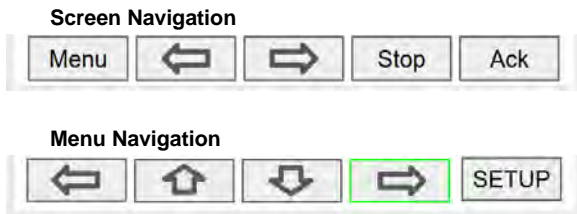

Selections are highlighted with green background for illustration purposes. The following keys are used to navigate through menus and edit settings. Other special keys appear throughout the programming process.

Note: This is not a touch-screen display; the five black rubber pushbuttons located below the display must be used to activate the soft-keys.

Function Keys

Key	Action
Menu	Enter menu
Right-key →	Step into menu/setting
Left-key ←	Exit/go back
Down-key ↓	Next screen/channel/setting
Up-key ↑	Previous screen/channel/setting
Stop	Stop automatic scan
Scan	Scan screens automatically
Ack	Acknowledge alarms/relays
Reset	Reset total/max/min
Setup	Enter the Setup menu
Edit	Modify selection
Enter	Execute keypad entry
Ok	Accept setting change
Save	Save all settings in view
Cancel	Discard changes
Delete	Delete channel/item
New	Create new channel/alarm
←	Move cursor left
→	Move cursor right
X→	Delete to the right
←X	Delete to the left
≡	Access additional settings or actions
Alert!	Flashing red: View new alarm alerts Steady red: Alarm alerts, already viewed
Alert!	Amber: View manually controlled outputs, simulated parameters, and warning about USB Drive not installed
Timer Ctrl	View menu: Allows controlling the timer
Start Log #	View menu: Press to start the log
Stop Log #	View menu: Press to stop the log
Log # Entry	View menu: Press to capture a log record
Remove USB	The Screens F4 key is assigned to the Remove USB function, by default, on units with data logger feature enabled. Press to safely remove the USB drive.

PID Function Keys

Key	Action
PID Tuner #	View and edit PID tuning parameters
Auto Tune #	Start auto tuning process
Start	Start (turn on) PID process
Stop	Stop (turn off) PID process
Abort	Abort auto tuning process

Batch Control & Printer Keys

Key	Action
Start	Start Batch
Stop	Stop Batch
Start/Stop	Start/Stop Batch
Pause/Stop	Pause/Stop Batch
Preset	Adjust Preset
Batch Ctrl	Access Batch Control screen
Start Size	Enter a new batch size & start batch
Start Partial	Enter partial batch & start batch
Force On	Turn on the batch relay while pressing
Force Off	Turn off the batch relay while pressing
Reset	Reset Batch
Print	Print Ticket
Print Screen	Print items displayed on the screen
On/Off	Turn printer On or Off
Clear	Clear printer error

Setup and Programming

There is **no need to recalibrate** the instrument when first received from the factory. Use the *Scale* function to set up the input channels to display your process in engineering units.
 The device is **factory calibrated** prior to shipment, for all input types and 4-20 mA outputs. The calibration equipment is certified to NIST standards.

Overview

Setup and programming are done through the front panel buttons or with the ConsoliDator+ software. After power and signal connections have been completed and verified, apply power to the instrument.

Inputs, outputs, channels, and relays are configured individually. It is recommended that all inputs be configured before channels, outputs, and relays are programmed.

Shown below are typical screens for tank level applications. Actual screens will vary according to the selected configuration. Screens can be edited, deleted, or added to fit the application.

For information on soft-keys and button functions, see *Soft-Keys and Buttons* on page 40.

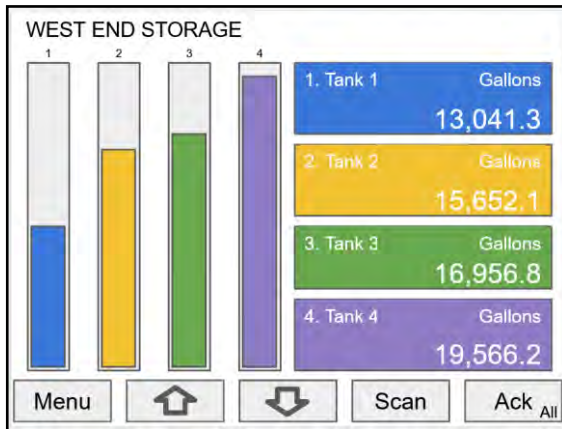

Typical screen view displaying 4 channels and 4 bargraphs representing the values of each channel.

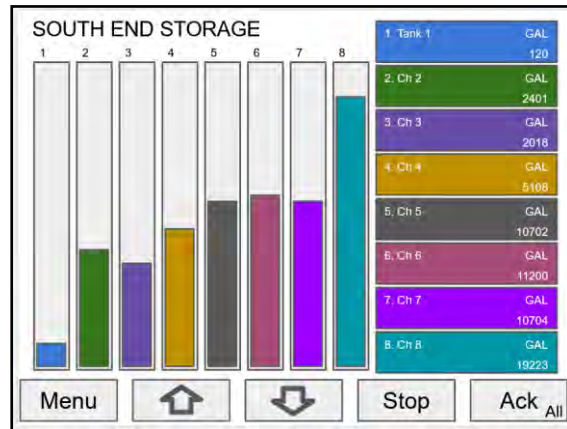

Typical screen view displaying 8 channels and 8 bargraphs representing the values of each channel.

Press the **Menu** key to begin setup and programming

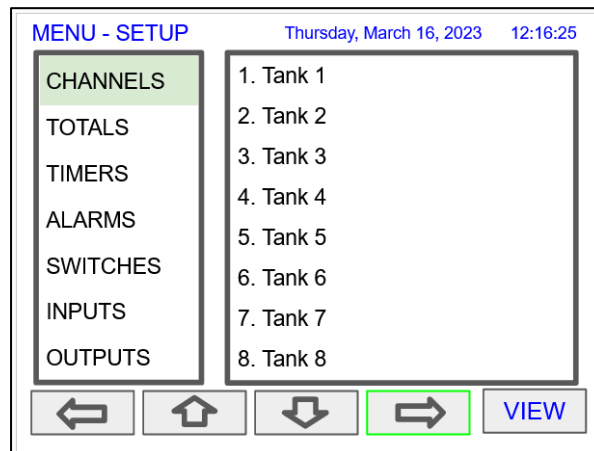

The View screen allows a user to view all the settings and values for Channels, Totals, Timers, etc. To program the instrument, press the **Setup** key.

Setup Menu

The *Setup* menu is the starting point during the programming process for setting up *Channels*, *Totals*, *Timers*, *Alarms*, *Inputs*, *Outputs*, *Screens*, and *System* settings. The number of channels shown on this screen is determined by the number of channels previously configured. More channels can be added to the list, by selecting *New* in the *Setup Channels* menu.

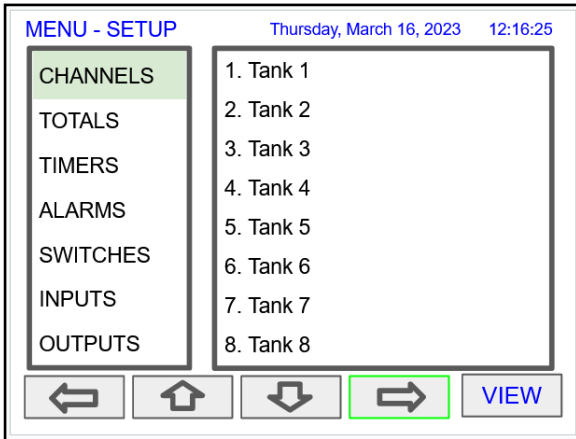

Press **Right Arrow** key to step into channels.

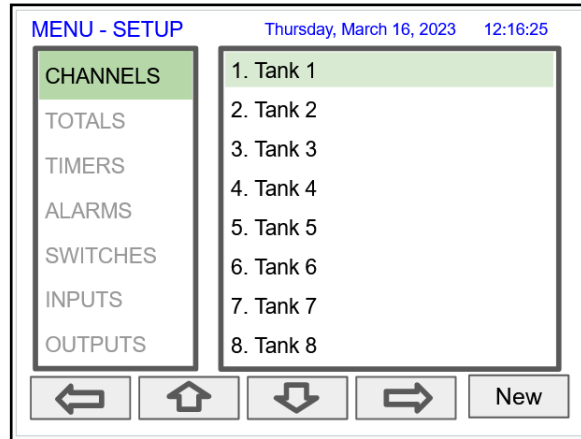

Press **New** key to create a new channel.
Go to page 47 for details.

Channel Parameters

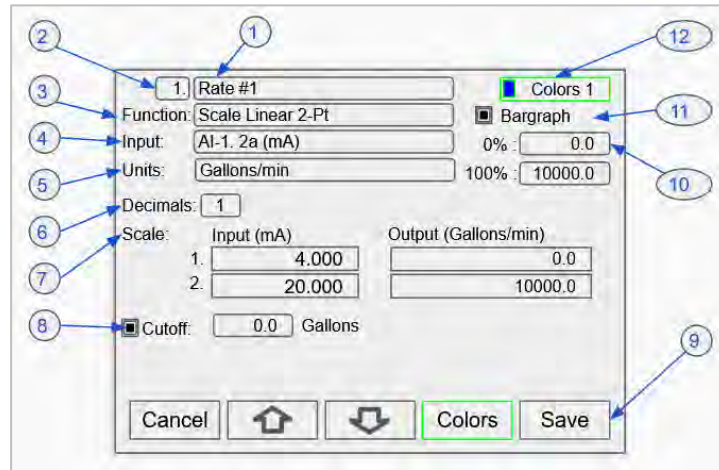

1. **Channel tag:** Editable
 2. **Auto-generated channel #:** Use to re-order channels
 3. **Function*:** This is the function applied to the input source
 - **Scale**
 - Scale Factor
 - Scale Linear 2-Pt
 - Scale Multi-Point
 - Scale Square Root
 - Scale Exponent
 - Round Horz Tank*
 - Units Conversion
 - Percent (Bargraph)
 - Text (Percent)
 - **Math**
 - Constant
 - Summation
 - Difference
 - Absolute
 - Difference
 - Absolute Value
 - Average
 - Weighted Average
 - Multiply
 - Divide
 - Exponent
 - Logarithm
 - Polynomial
 - Modulo
 - Trigonometry
 - % Efficiency
 4. **Input:** Source for the channel (PV)
 - mA Input (4-20 mA)
 - Pulse Input
 - Digital Input
 - Modbus Input
 - Temperature Input
 - Channel
 - Total
 - Timer
 - Alarm
 - mA Output
 - Relay Output
 - Digital Output
 - Modbus Output
 5. **Units:** Engineering units / time or none
 - None
 - Time
 - Distance (Height)
 - Volume
 - Pressure
 - Weight
 - Temperature
 - Percent
 - Amps
 - Volts
 - Counts
 - Logic
 - Custom
 6. **Decimals:** Number of decimals for the PV
 7. **Input scale:** Enter input and output values
 8. **Cutoff:** PV goes to zero below the cutoff value
 9. **Soft keys:** These change based on the screen in place
 10. **Bargraph scale:** Set the 0 and 100% values
 11. **Display bargraph:** Display on the screen
 12. **Colors:** Select the bargraph & panel colors
- See *Channel & Math Functions* on page 19 for details.

Data Entry Keypad

The system provides a soft keypad for entering values and tags; it contains numbers, alpha characters, and symbols.

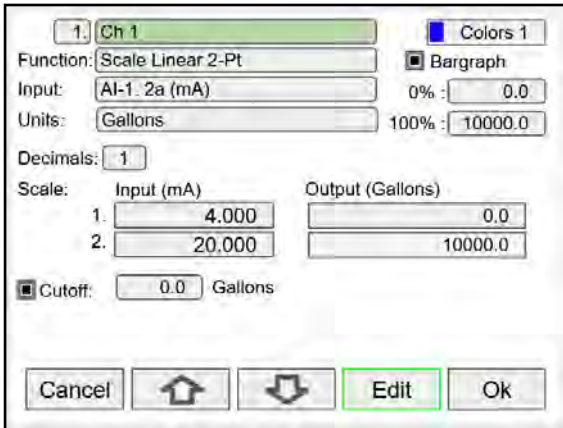

Press **Edit** key to start editing the channel configuration.

The green background indicates the field to be edited. Press **Edit** key again to change the channel's tag, this opens the data entry keypad.



Use the Down Arrow key to navigate to the keypad. Use the **|>** and **<|** keys to move the cursor and use the **X→** key to delete characters. To enter characters in the selected text field, use the **arrow** keys to navigate through the popup keypad.

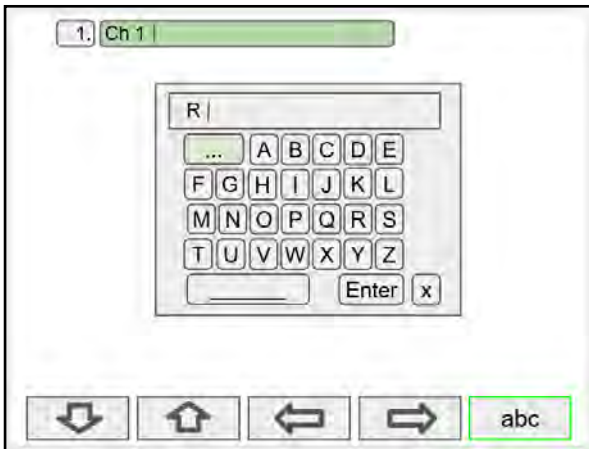

To change the character set, navigate to the **three dots** and press the key indicating the next set of characters.

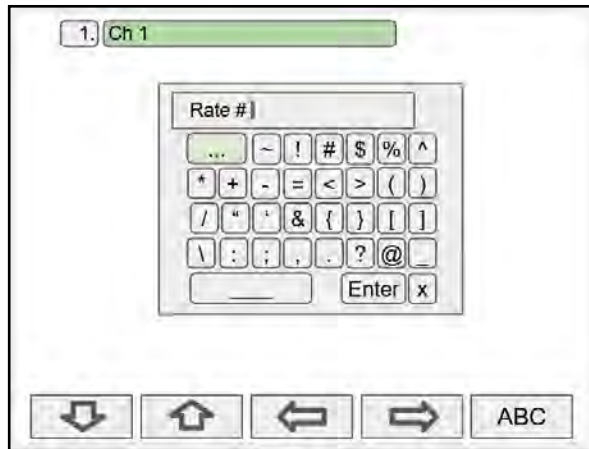

To enter symbols, press the **three dots** and select the desired symbol.

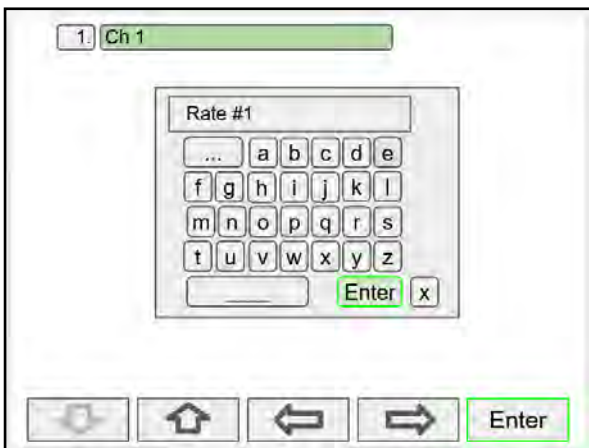

When done typing the characters in the selected field, press the **Enter** key.

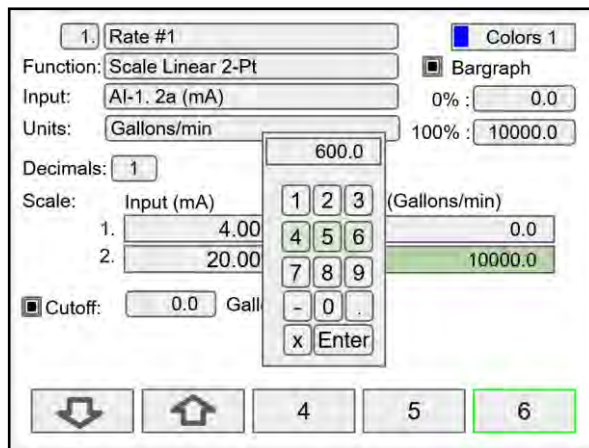

To enter numbers, select the numeric keypad, move the cursor to the insertion point and enter the number using the soft keys.

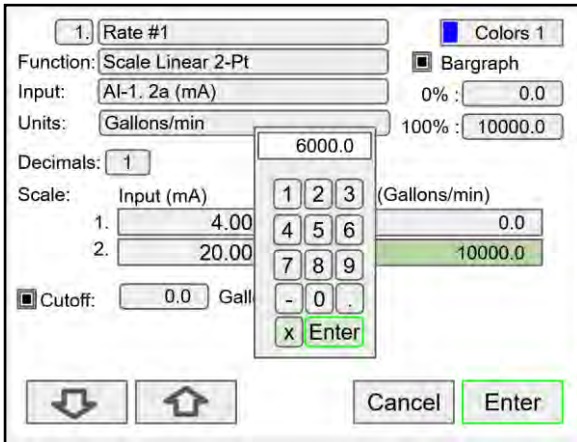

Press **Enter** to accept the changes.

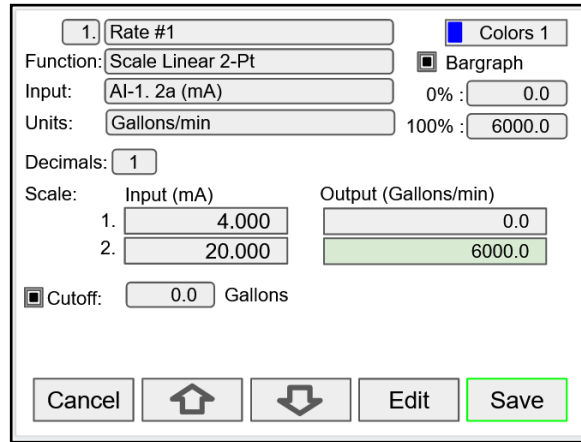

Press the **Save** key to save the changes. The bargraph is automatically adjusted to reflect the scale entered. The bargraph scaling can be changed without affecting the input scaling.

Setup Channels

The *Setup Channels* menu is used to configure each channel, enter a tag, select the input source, scale the input, and program other settings that will determine the channel's processing capabilities.

- Use the **Arrow** keys to navigate through the existing channels
- Press the **New** key to create a new channel
- Press the **Right Arrow** key to step into the channel setup
- Press the **Edit** key to make changes to a particular channel
- Press the **Delete** key to delete a channel

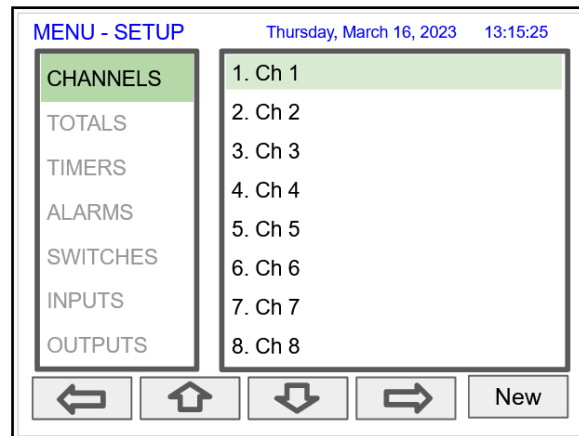

Create New Channel

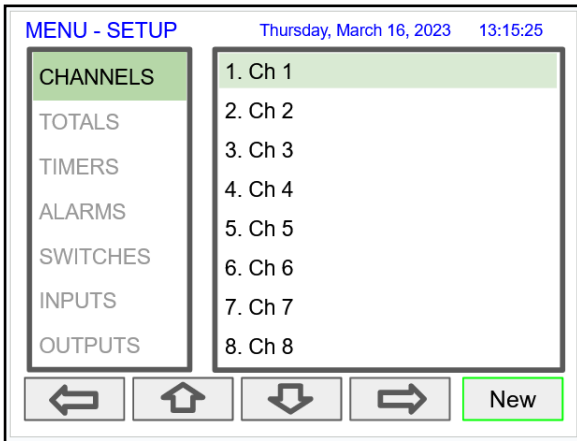

To create a new channel press the **New** key.

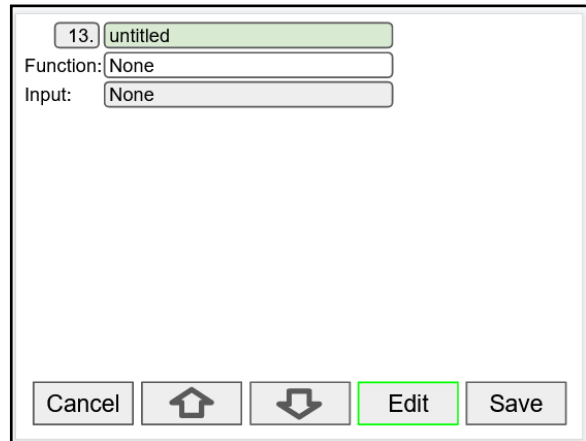

Press the **Edit** key to edit the channel tag and other settings. Press the **Up** and **Down** arrow keys to select setting to be edited.

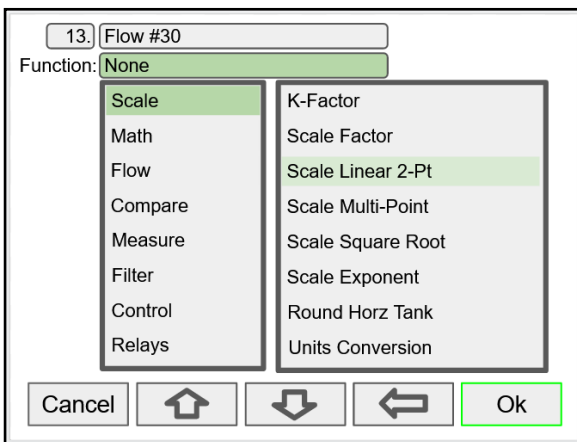

Select the function to be applied to the input and press the **Ok** key.

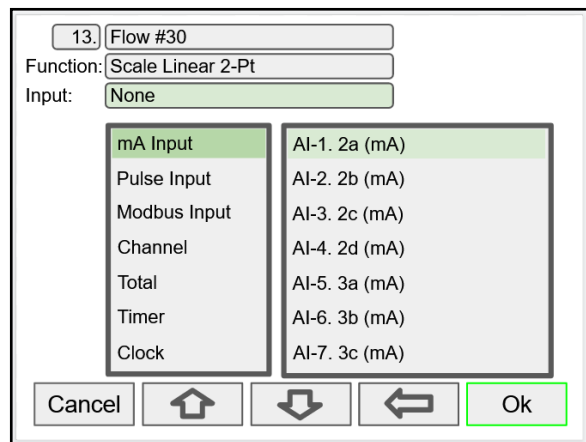

Select the input source for the channel.

Note: The inputs shown depend on the installed hardware and the configuration.

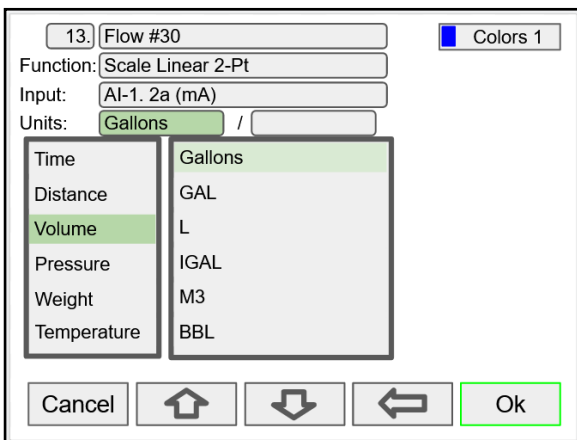

Select the engineering units, decimal point, enter scale points and press the **Ok** key.

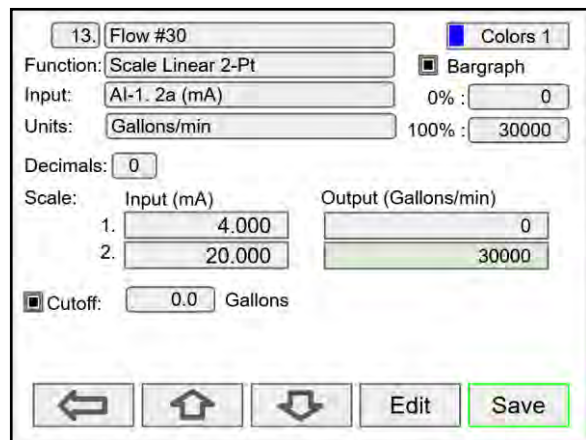

Select number of decimals, scale the input, enter the cutoff value, select colors for bargraph and text, confirm the bargraph's scale, and press **Save**.

Feet & Inches Engineering Units

The Feet & Inches (Ft-In) units are entered in feet, inches, and decimal of an inch. The number of decimals selected correspond to the inches portion of the value.

The View and Screens show the feet value followed by the feet symbol, followed by the inches with decimals followed by the inch symbol (e.g. 48' 0.0").

The mA output from a level sensor can be displayed as level in feet & inches using one channel and as volume using a second channel.

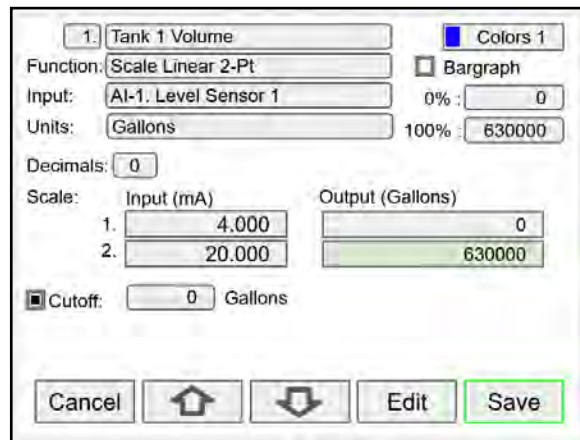
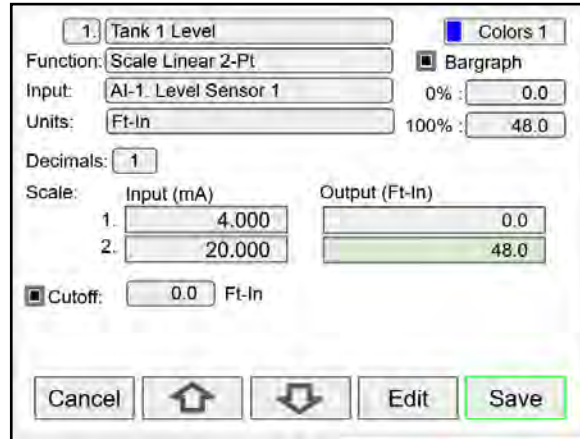

Screen with Feet & Inches Units

The screen to the right shows the level and volume of two tanks; the level is displayed in feet & inches and the volume in gallons.

According to the dimensions of the tank used in this example, the maximum height is 48 feet and the maximum volume is 630,000 gallons. The tank diameter is 48 feet.

Because of the large signal amplification, the volume can fluctuate significantly while filling or emptying the tank. You can use the *Rounding* function to obtain a more stable reading (e.g. Round to nearest 50).

To create a channel with rounding function:

Go to Setup > Channel > Function > Filter > Round, and enter the desired rounding value.

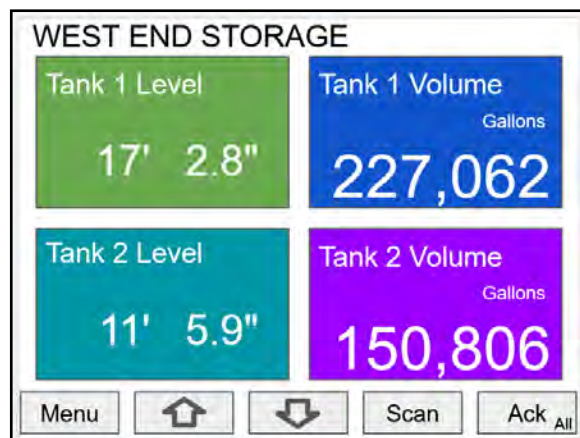

Bargraph, Background & Text Colors

13. Flow #30 Colors 1

Function: Scale Linear 2-Pt Bargraph

Input: AI-1. 2a (mA) 0% : 0

Units: Gallons/min 100% : 30000

Decimals: 0

Scale: Input (mA) Output (Gallons/min)

1. 4.000 0

2. 20.000 30000

Cutoff: 0.0 Gallons

Cancel [Home] [Down] Colors Ok

To select a channel color pattern, navigate to the Colors setting and press the **Colors** key.

Colors Colors 1

Default Text: █

Colors 1 Background: █

Colors 2 Bargraph: █

Colors 3

Colors 4 Show Alarm Condition

Colors 5 Using Alarm Color Settings.

Colors 6

Colors 7

Select [Home] [Down] Edit New

Select a color pattern or press the **Edit** key to make changes to the colors' tag, text, background, and bargraph.

Colors Colors 1

Default Text: █

Colors 1 Background: █

Colors 2 Bargraph: █

Colors 3

Colors 4 Show Alarm Condition

Colors 5 Using Alarm Color Settings.

Colors 6

Colors 7

Manage

Cancel [Home] [Down] Edit Ok

Use the arrow keys to navigate the settings and press **Edit** to make changes.

Colors Colors 1

Default Text: █

Colors 1 Background: █

Colors 2 Bargraph: █

Colors 3

Colors 4 Show Alarm Condition

Colors 5 Using Alarm Color Settings.

Colors 6

Colors 7

Manage

Cancel [Home] [Down] Edit Ok

Press **Edit** to change text color, this applies to the channel tag, units, and value.

Colors Colors 1

Default Text: █

Colors 1 Background: █

Colors 2 Bargraph: █

Colors 3

Colors 4

Colors 5

Colors 6

Colors 7

Cancel [Home] [Down] Edit Ok

Select the desired color and press **Ok**. Navigate to the other settings and make the necessary changes.

Colors Colors 1

Default Text: █

Colors 1 Background: █

Colors 2 Bargraph: █

Colors 3

Colors 4 Show Alarm Condition

Colors 5 Using Alarm Color Settings.

Colors 6

Colors 7

Manage

Cancel [Home] [Down] Edit Ok

Press **Save** to save the color changes. Press **Select** to apply the color pattern to the channel. The **Manage** button is used to move or delete colors.

Live Calibration

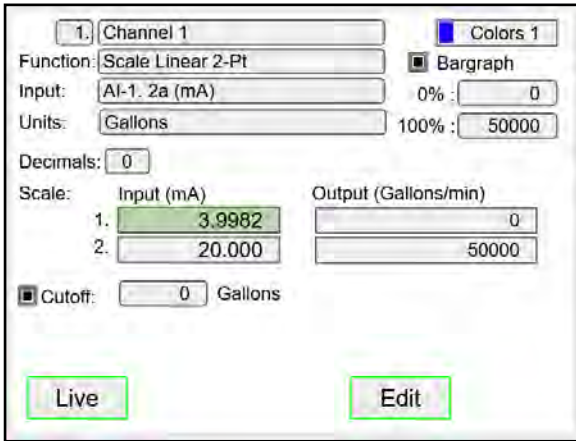

The *Live Calibration* feature is used to calibrate a channel by applying a live calibration signal.

1. From the Setup menu, navigate to the channel to be calibrated.
2. Go to Input 1 entry box
3. Apply Input 1 signal from sensor or calibrator
4. Press & hold the Edit key and press the Live key a few time until a stable reading is displayed.
5. Release the Edit key; the input 1 value has been captured.
6. Repeat the steps above for the additional inputs to be calibrated.
7. Adjust the output values according to the calibrated inputs.
8. Press Save.

Edit Channel

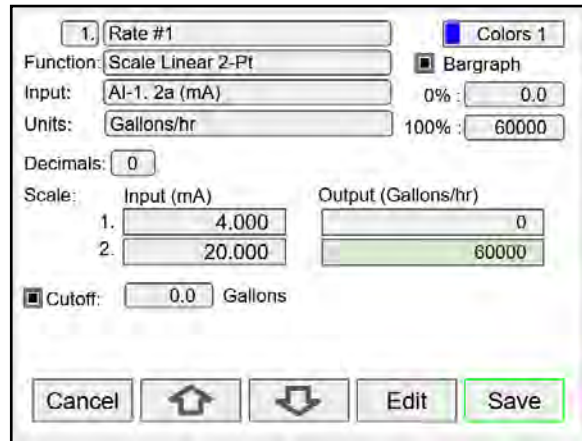
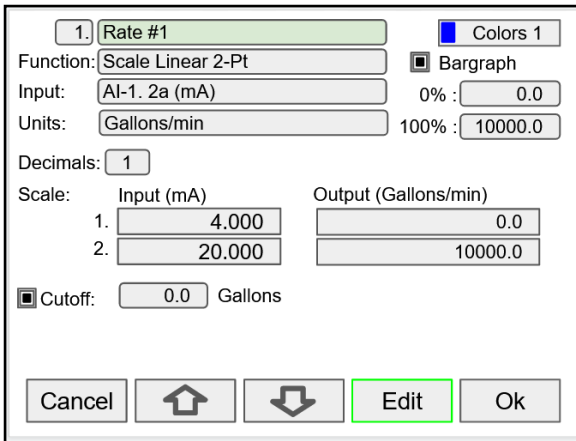

To edit a channel press the **Edit** key and navigate to the setting you want to change, press **Edit** again and make the changes required.

After making all the changes, press the **Save** key.

Delete Channel

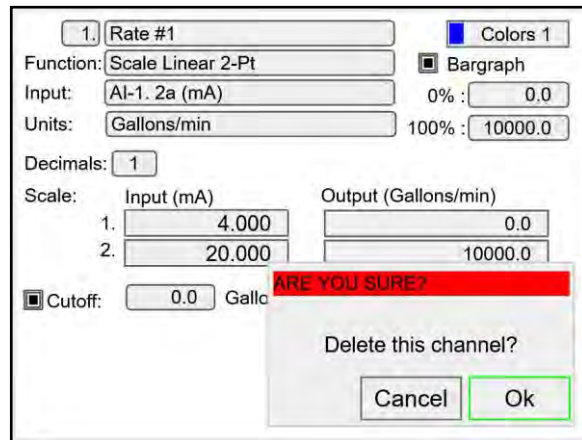
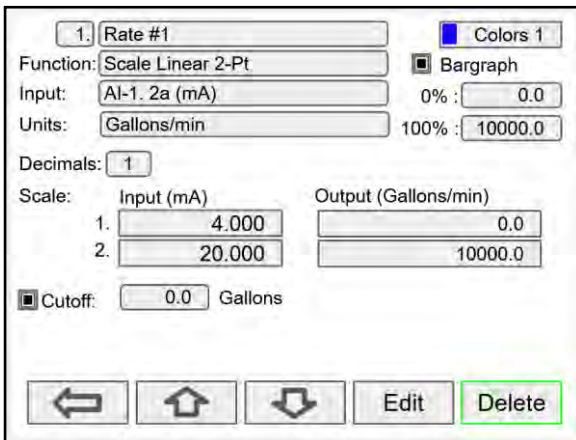

To delete a channel, press the **Delete** key and follow the instructions.

Press the **Ok** key to delete the channel or the **Cancel** key to cancel delete action.

Scale Functions

Channels can be configured using various functions to fit a particular application.

- K-Factor
- Scale Factor
- Scale Linear 2-Point
- Scale Multi-Point
- Scale Square Root
- Scale Exponent
- Round Horizontal Tank
- Units Conversion
- Percent (Bargraph)
- Text (Percent)

2-Point Linear Scaling

Linear mode refers to basic 2-point scaling of a 4-20 mA signal in engineering units. The graph in Figure 28 shows the display response based on example scaling parameters. For this mode select [Scale Linear 2-Pt] from *Function* options, then enter your scaling parameters.

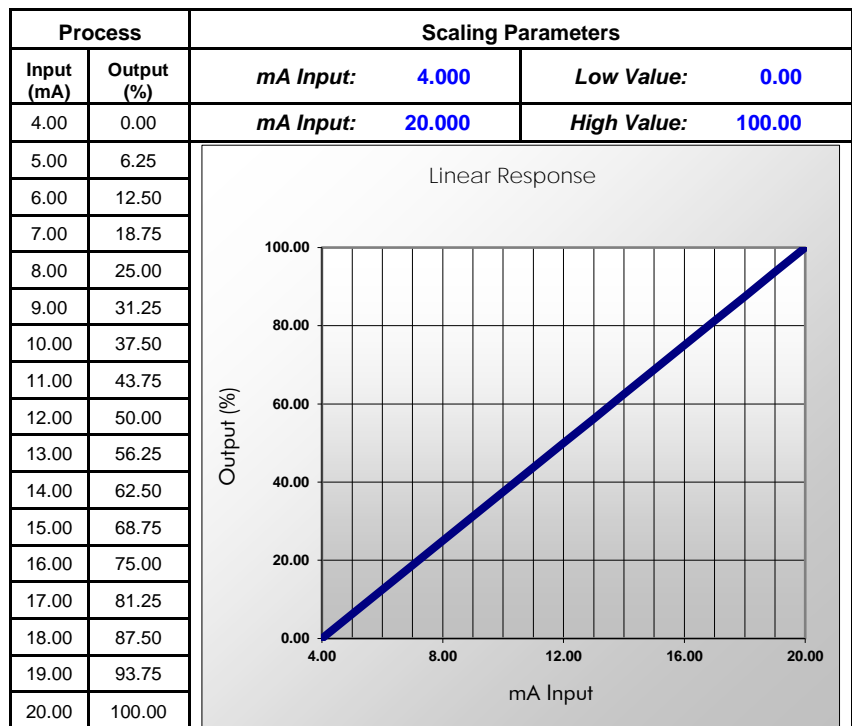

Figure 28. Linear Response Graph

Square Root Scaling

Square root mode refers to 2-point scaling with square root extraction typically used to linearize the signal from a differential pressure transmitter and display the flow rate in engineering units. The graph in Figure 29 shows the display response based on example scaling parameters. For this mode select [Scale Square Root] from Function options.

The square root mode supports low-flow cutoff which can be used to suppress readings below a programmed value. Below the cutoff value, the controller will display "0".

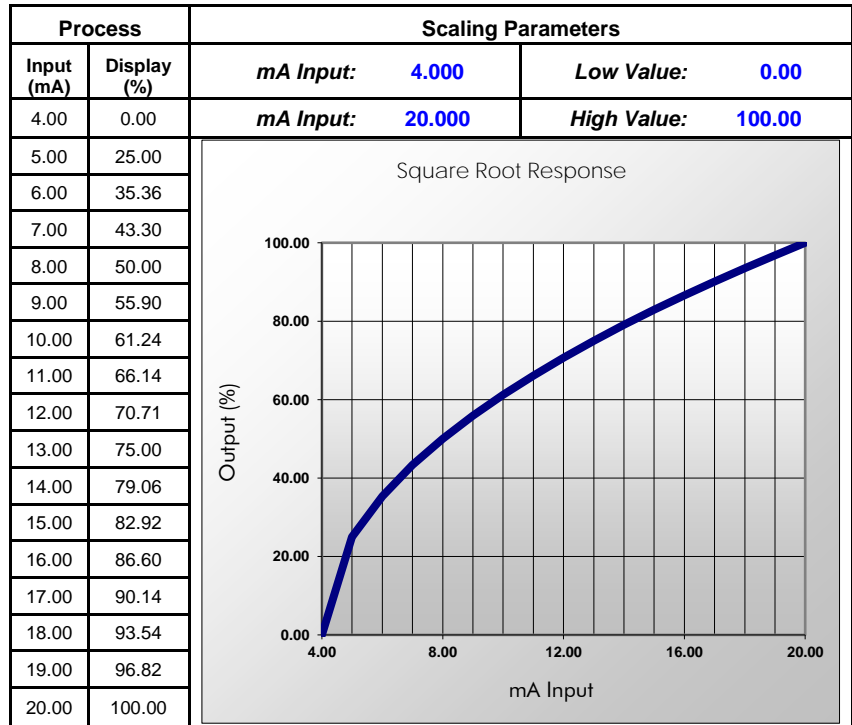

Figure 29. Square Root Response Graph

Scale Exponent

Exponent mode refers to 2-point scaling with programmable exponent, typically used in open-channel flow applications using weirs and flumes to linearize the signal from a level transmitter and display the flow rate in engineering units. The graph in Figure 30 shows the display response based on example parameters and exponent of "1.5". For this mode select [Scale Exponent] from *Function* options. The exponent mode supports low-flow cutoff which can be used to suppress readings below a programmed value. Below the cutoff value, the controller will display "0".

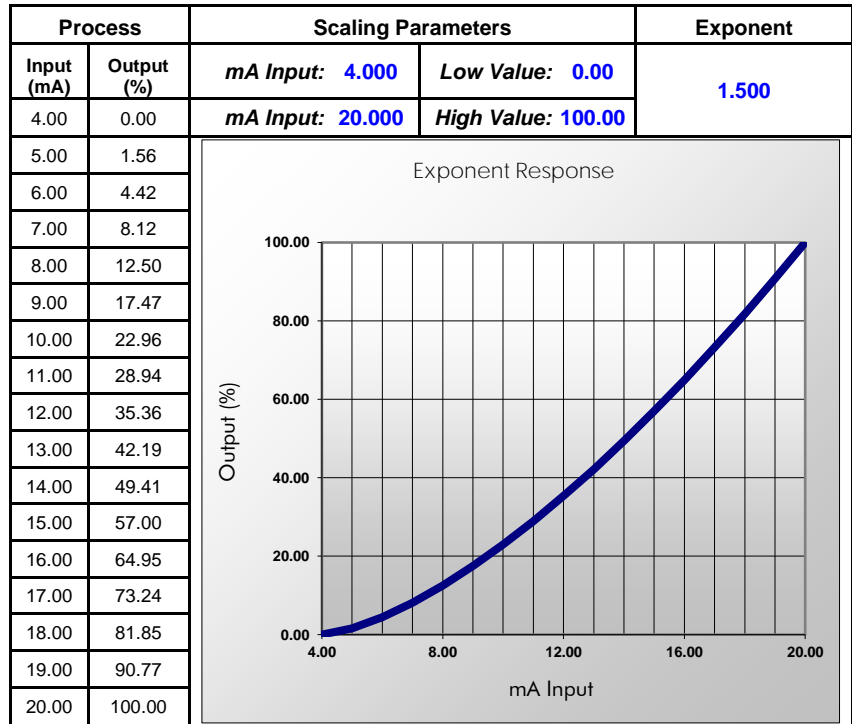

Figure 30. Exponent Response Graph

Round Horizontal Tank

The *Round Horizontal Tank* (RHT) function calculates the volume of round tank with flat ends, based on the diameter and length dimensions of the tank.

The input source for the channel calculating the volume must be a level channel with units of distance (height). The RHT function linearizes the signal from a level transmitter and displays the volume in engineering units. The graph in Figure 31 shows the display response based on tank example:

Diameter = 48.00 inches
 Length = 120.00 inches
 For this mode select [*Round Horz Tank*] from *Function* options.

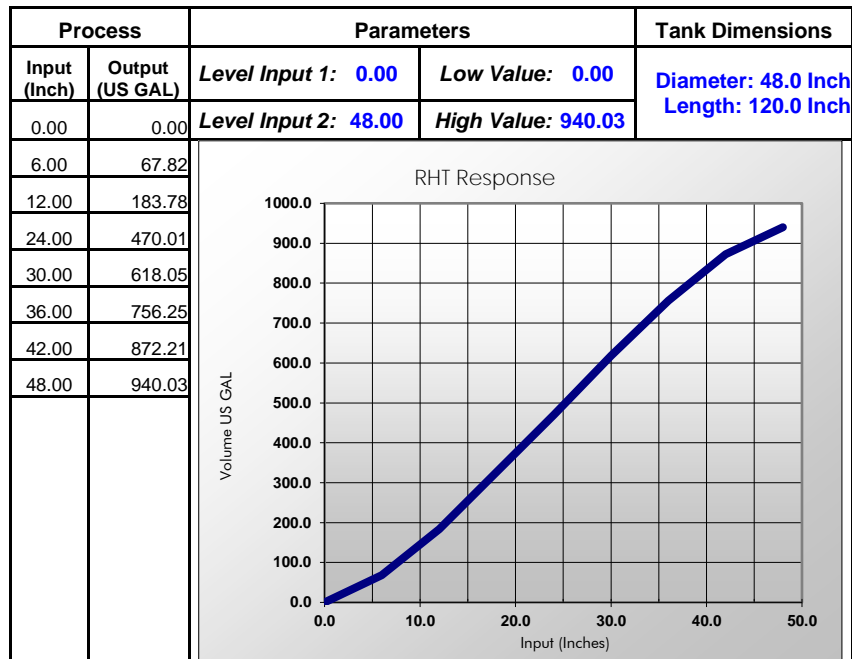

Figure 31. Round Horizontal Tank Volume Graph

Open Channel Flow Application

The ConsoliDator+, in combination with a level transmitter, makes for a practical way to measure and display open channel flow rate and total in most weirs and flumes and take periodic samples. There are two ways the user can program the ConsoliDator+ for open channel flow applications:

Programmable Exponent: In this method, all the user needs to do is enter the exponent for the weir or flume into the ConsoliDator+ and the controller automatically raises the input signal to that power. For instance, to display open channel flow rate and total from a 3-inch Parshall flume and take a one pint sample every 100,000 gallons, the user would program the ConsoliDator+ as shown in the upper table on the right.

Specific Weir or Flume Function: In this method, the user selects one of the following functions to be applied to the input from a menu in the ConsoliDator+: Parshall Flumes, V-Notch Weirs, Cipolletti Weirs, Rectangular Weirs with or without Contractions. The second table on the right shows the parameters the user then enters.

In addition, a total can be set as non-resettable, and a relay can be programmed to take a sample at user-defined intervals.

Programmable Exponent for Open Channel Flow

Function	Desire	Programming
Open Channel Flow	3" Parshall flume	Use Scale Exponent function Set Exponent to 1.547
Flow Rate 1	Millions of Gallons per Day (MGD)	Set 4 mA: 0 Set 20 mA: 3.508 Custom unit: MG; Time base: day Flow rate units: MG/day
Total 1	Millions of Gallons	Input: Flow Rate 1 Select unit = MG
Sampling Channel 2	Take a 1 pint sample every 100,000 gallons	Input: Total 1 Function: Sampler Sample Interval: 0.1 MG Sample Time: 10 sec
Sampling Relay 1	Turn valve on to take a sample	Input: Channel 2 (On / Off) Use a timer to count the time needed to take the sample
Total 2 Non-Resettable	Program controller so total 2 can never be reset	Input: Flow Rate 1 Set total 2 as non-resettable total
Screen	Display flow rate, totals, and relay status	Set a screen to display rate, total 1, total 2, and relay status.

Specific Weir or Flume Function for Open Channel Flow

Function	Desire	Programming
Open Channel Flow	3" Parshall flume	Create Channel 1 to measure head height 4 mA = 0 feet 20 mA = 3.000 feet
Flow Rate 1	Millions of Gallons per Day (MGD)	Create Channel 2 for flow rate Use Flow - Parshall Flumes function Constant K = 0.992 Head = Channel 1 head height Custom unit: MG; Time base: day
Total 1	Millions of Gallons	Input: Flow Rate 1 Select unit = MG
Sampling Channel 2	Take a 1 pint sample every 100,000 gallons	Input: Total 1 Function: Sampler Sample Interval: 0.1 MG Sample Time: 10 sec
Sampling Relay 1	Turn valve on to take a sample	Input: Channel 2 (On / Off) Use a timer to count the time needed to take the sample
Total 2 Non-Resettable	Program controller so total 2 can never be reset	Input: Flow Rate 1 Set total 2 as non-resettable total
Screen	Display flow rate, totals, and relay status	Set a screen to display rate, total 1, total 2, and relay status.

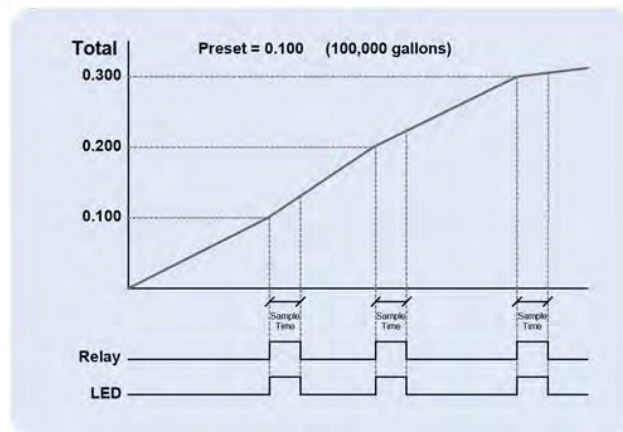

Figure 32. Total Relay Sampling Operation

Scale Multi-Point

The *Scale Multi-Point* function is used to linearize the signal from sensors with non-linear output or sensors used to measure volume in odd-shape vessels, where a 2-point scale cannot be used to get accurate readings. Another application for multi-point scaling is in open channel flow using weirs and flumes with flow equations not covered by the functions provided in the controller.

- Create a channel
- Function: Scale Multi-Point
- Input: Select the input sensor
- Units: Select engineering units
- Decimals: Number of decimals to display
- Scale: Insert the input and output values
- Cutoff: Select and enter the cutoff value

1: Tank 1 Volume Colors 1

Function: Scale Multi-Point Bargraph

Input: AI-1: Level Sensor 1 0%: 0

Units: Gallons 100%: 60000

Decimals: 0

Scale:	Input (mA)	Output (Gallons)
1.	4.000	0
2.	8.000	9000
3.	12.000	20000
4.	20.000	60000

Cutoff: 0 Gallons

Cancel Home Back Edit Save

The controller can be configured with up to 50 linearization points. The use of the ConsoliDator+ software is highly recommended for entering the linearization points.

Setup Math Functions

There are many math functions that can be applied to any channel, which allows the execution of simple or complex math functions. Math channels can be the source for other math channels, totalizers, alarms, and analog outputs.

List of Math Functions

1. Constant
2. Summation
3. Difference
4. Absolute Difference
5. Absolute Value
6. Average*
7. Weighted Average
8. Multiply
9. Divide
10. Exponent
11. Logarithm
12. Polynomial
13. Modulo
14. Trigonometry
15. % Efficiency

*Average can be used for applications requiring redundant sensors by selecting the *Exclude Fail Input* feature. The two 4-20 mA inputs must be set to break below a failed level value.

Application Example: % Efficiency

Description: Calculate the VOC Destruction Efficiency in a Thermal Oxidizer

Thermal Oxidizer Efficiency =

$$(\text{Inlet VOC} - \text{Outlet VOC}) / \text{Inlet VOC}$$

4-20mA output = 0-100% efficient

$$\text{Efficiency} = ((\text{Ch1} - \text{Ch2})/\text{Ch1}) * 100$$

Ch1 = Inlet VOC

Ch2 = Outlet VOC

AO-1 Source = Ch 20. VOC %Efficiency

AO-1 Scale: 4-20 mA = 0-100% efficiency

VOC: Volatile Organic Components

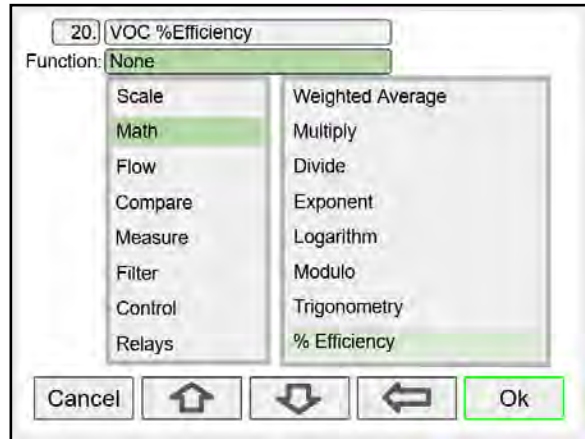

Select math function for % Efficiency and press **Ok**.

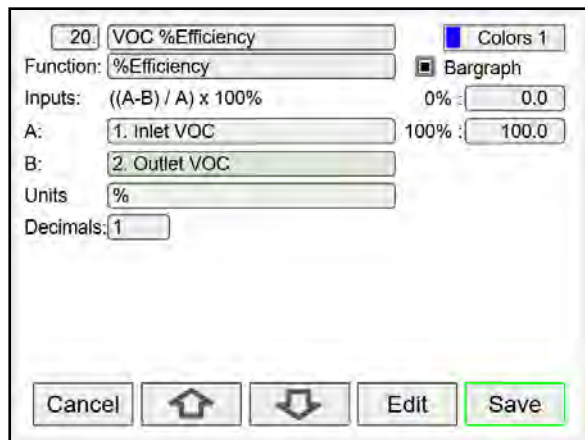

Enter the input sources for the math function, select the units and number of decimals, and press **Ok** and **Save**

Additional Functions

Scale

- K-Factor
- Scale Factor
- Scale Linear 2-Pt
- Scale Multi-Point*
- Scale Square Root
- Scale Exponent
- Round Horz Tank
- Units Conversion
- Percent (Bargraph)
- Text (Percent)

Open Channel Flow

- Parshall Flumes
- V-Notch Weirs
- Cipolletti Weirs
- Rectangular Weirs with End Contractions
- Rectangular Weirs w/o End Contractions

Compare

- Greatest
- Least
- Middle of 3
- Less Than

Measure

- Tare
- Maximum
- Minimum
- Duration
- Rate of Change

Filter

- Window Average
- IIR (First Order)
- Cutoff
- Limits
- Round
- Hysteresis
- Delay
- Pulse Filter

Control

- Sampler
- On-Off Control
- On-Off Multi-Set
- Lead-Lag Control
- Pump Alternation
- Logic OR, AND, NOT
- Select (A or B)
- Select 1,2,3...
- Schedule
- Capture
- PID Control
- PWM Control
- Switch Position

Relays

- Cycle Count
- Runtime

Modbus

- Time Since Read
- Time Since Write

Bitwise

- Bitwise Constant
- Bitwise Hex
- Bit Test
- Bitwise OR, AND, NOT
- Bitwise RSH, LSH
- Bitwise Map
- Bitwise Count
- Bitwise First, Last

▲ IMPORTANT

***Scale Multi-Point:** There is no minimum input span requirement; it is up to the user to make sure the input values are correct.

Random Varying On-Off Control

The *On-Off Control* with the *Randomizer* function is used to prevent grease buildup in tank level control applications.

The controller randomly varies the *On* and *Off* points within the user-selected range.

- Create a channel
- Function: On-Off Control
- Input: Level or volume channel
- Enter On / Off points
- Enter the allowed +/- deviations

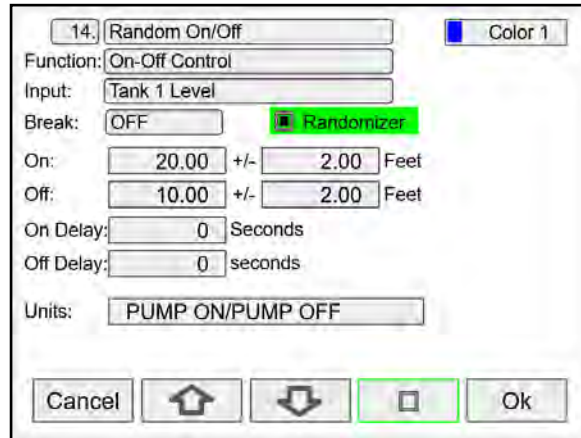

After creating the On-Of Control with Randomizer channel, assign this channel as the input for the relay controlling the pump.

Control – Select 1,2,3 ...

The *Select 1,2,3* control function is used as a selector switch to select from 3 or more sources to be the output for the channel.

The input for the *Select* function must be capable of providing the values corresponding to the selection indexes (*i.e.* 0, 1, 2, 3, etc.).

- First create a channel to generate the switching points values (0, 1, 2, 3, etc.)
- Create a channel to switch the inputs
- Function: Select 1,2,3...
- Input: Channel with multi-point scaling or Modbus input.
- Selection: Insert the parameters to selected for the channel output.

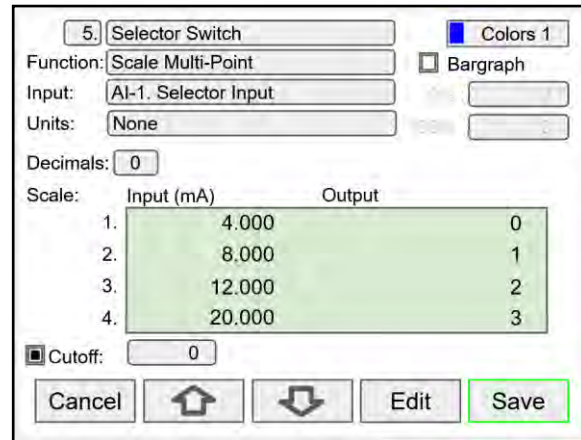

After creating the multi-point channel, assign this channel as the input for the channel with the *Select 1,2,3* function.

Select 1,2,3 Function Operation

1. Input AI-1 @ 4 mA
Selector Switch channel 5 = 0
Channel 6. Switched Output displays Tank 1
2. Input AI-1 @ 8 mA
Selector Switch channel 5 = 1
Channel 6. Switched Output displays Tank 2
3. Input AI-1 @ 12 mA
Selector Switch channel 5 = 2
Channel 6. Switched Output displays Tank 3
4. Input AI-1 @ 20 mA
Selector Switch channel 5 = 3
Channel 6. Switched Output displays Tank 4

The input for the *Select 1,2,3* function can be a Modbus input value received from a Modbus Client.

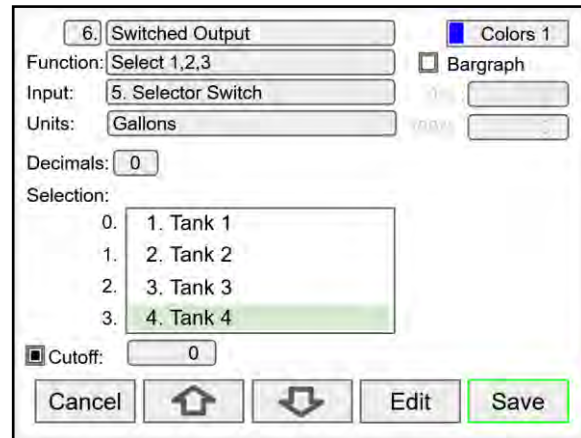

PID Control Setup

The ConsoliDator+ can be set up with up to 8 control loops*; the following steps show an example of the PID setup process.

1. Channel 1: PV
Configure a channel with the 100 ohm platinum RTD input.
2. Channel 2: Set Point
This is the target setpoint for the process, which can be adjusted using the function keys.
3. Channel 3: Power
Configure the initial PID Control parameters. These determine the power provided to Pulse Width Modulation (PWM) channel.
 - Bidirectional (Heating & Cooling)
 - Not Reverse (Heating)
 - Reverse (Cooling)
4. Channel 4: PWM Control
Configure the PWM Control channel to take the input from the Power channel and provide the control signal to the output controlling the load.
5. PID Control Output
Select the output from the ConsoliDator+ that is intended to control the device driving the load.
 - Digital Output: Connected to Solid State Relay
 - Analog Output: Connected to a power controller with 4-20 mA control signal.
 - Relay Output: Connected to a low power control relay.

6. PID Control Screen
Configure the PID Control screen to show:
 - PV
 - Set Point
 - Power (%)
 - Assign function keys
F1: PID Tuner (Manual)
F2: Auto Tune
F3: Set Point 1
F4: Next Screen

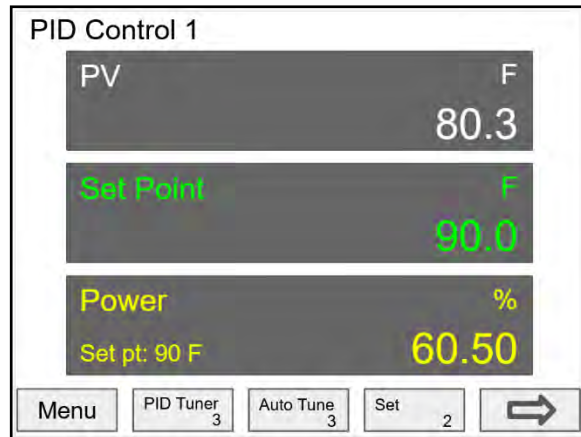

PID Controller: Block Diagram for Heating

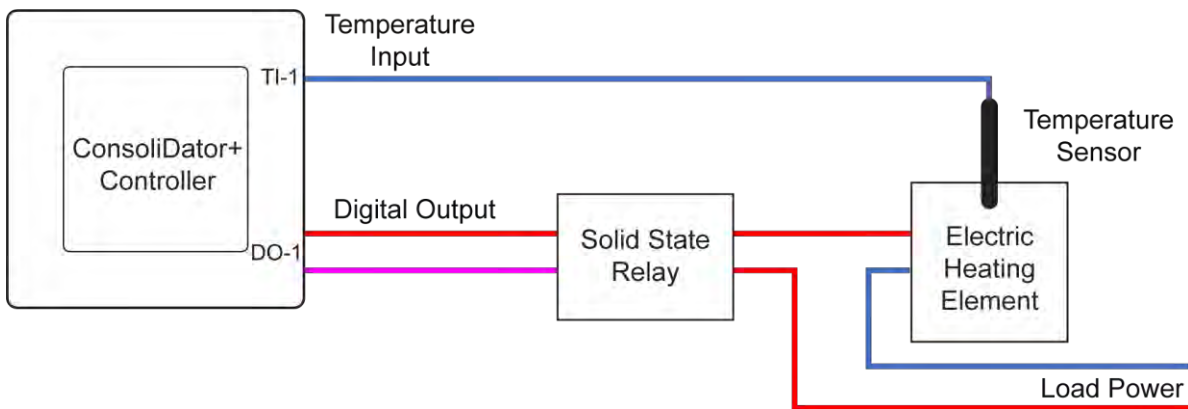

The following screens show the process for setting up a PID control application for heating. The values shown are for illustration only.

*It is possible to set up more than (8) PID control loops, contact Tech Support for details.

Setup Channel 1: PV

The first step is to set up the channel for the PV. In this example an RTD temperature sensor is used.

1. Ch 1 Default

Function: None Bargraph

Input: TI-1. 6a (Temp) 0%: 0.00

Units: F 100%: 100.00

Decimals: 2

← Home → Edit Delete

Channel 2: Set Point

Channel 2 is set up with a constant that will be used to change the set point using a function key and the target set point can be displayed in the PID Control screen.

2. Set Point Bargraph

Function: Constant 0%: 0.00

Units: F 100%: 100.00

Decimals: 1

Value: 90.0 F

Cancel Home → Edit Ok

Channel 3: Power

Channel 3 is set up with the PID Control function.

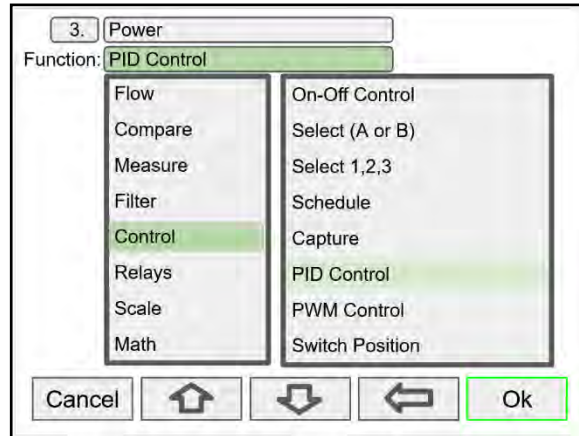

The input for the PID control is the value reported by the PV channel.

The Set point uses the constant set up in channel 2.

- Start/Stop: If selected, a function key or digital input can be used to start & stop the PID control.
- Bidirectional: This is used for heating & cooling.
- Reverse: Select for cooling only.
- Hysteresis: This is used for switching between heating & cooling outputs.
- Tuning Parameters: These values determine how fast the target set point is reached and how much overshoot occurs. It is best to run the Auto Tune function and then make any adjustments, if necessary.

Note: Auto Tune and Manual tune functions are assigned to function keys in the Screens menu.

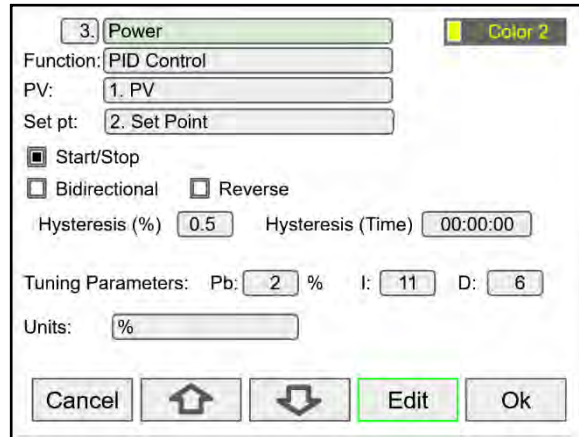

Channel 4: PWM Control

Channel 4 is set up as the Pulse Width Modulation (PWM) control channels. This channel provides the signal to the actual hardware outputs:

- 1) Digital output or
- 2) Relay

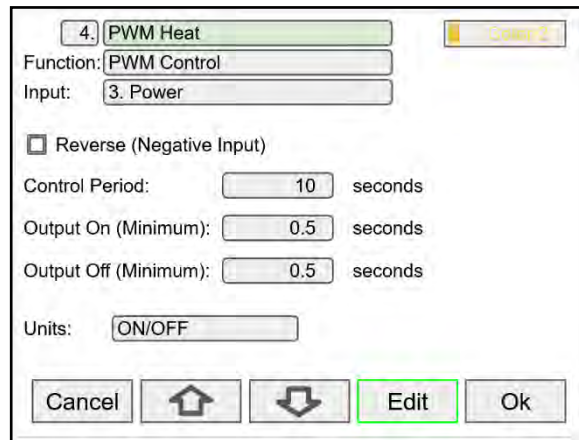

PID Control Using Digital Output

In this example, digital output 1 (DO-1) takes the input from the PWM channel (4. PWM Heat); DO-1 drives a low voltage Solid State Relay (SSR 1). The SSR 1 in turn drives the load or a larger relay.

PID Control Using Analog Output

In this example the signal from the PID Control channel (3. Power) is used to control a 4-20 mA analog output (AO-1). The analog output is connected to a power controller, which in turn drives the load.

PID Control Using Mechanical Relays

PID Control Using Mechanical Relays
Mechanical relays can be used to control slow PID processes, the internal relay can drive a high voltage SSR (Solid State Relay).

In this example, relay 1 (RY-1) takes the input from the PWM channel (4. PWM Heat); RY-1 drives a high voltage Solid State Relay (SSR). The SSR in turn drives the load.

Note: Mechanical relays are not recommended for PID control because of the large number of cycles needed to maintain the process at the target set point.

PID Control Screen

Finally set up the PID screen to display the PV, Set Point, and the % Power being delivered to the load. The function keys can be assigned the following functions:

- F1: Manual PID Tuner
- F2: Auto Tune PID
- F3: Set Point
- F4: Navigate to the next screen

Additional screens can be used to display other parameters:

- Analog inputs
- Set point channels
- PWM status
- PID Start/Stop function key
- Analog outputs

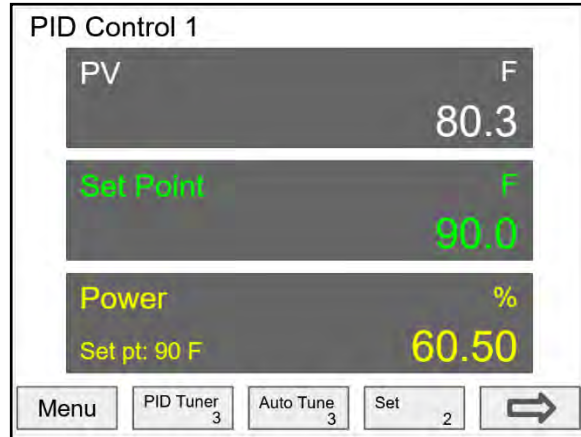

The Switches function can be used to change the target set point using a function key or a digital input.

Start / Stop PID with Digital Input

A digital input or a function key can be used to start/stop the PID control process.

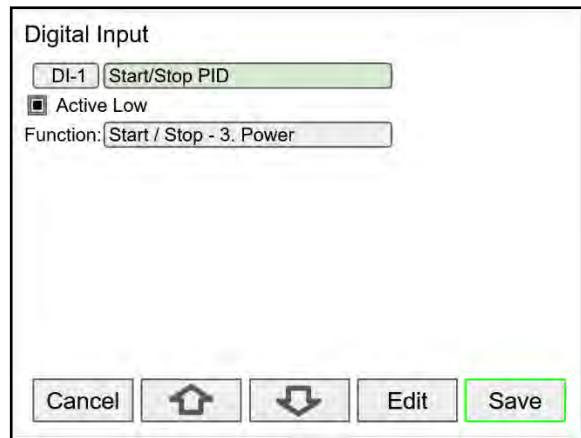

PID Control Adjustments

Issue	Try This
There is too much overshoot	1) Increase the Proportional band (Pb) 2) Increase the Derivative (D) setting
The process is too slow to reach the target	1) Decrease the Proportional band (Pb) 2) Increase the Integral (I) setting

Note: The PID controller response time is 1 second.

PID Controller: Block Diagram for Heating & Cooling Using SSR

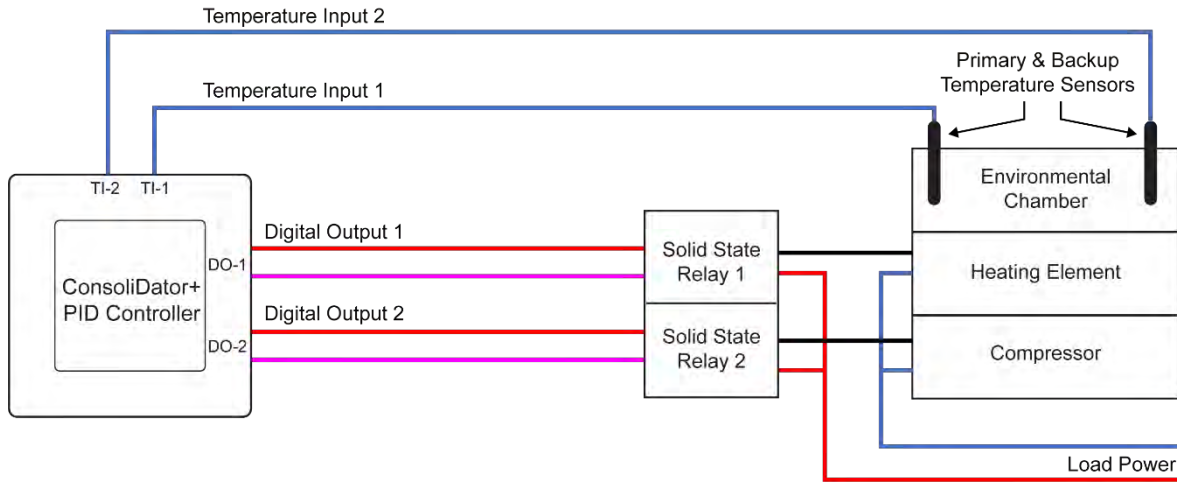

Channel 3: PID Control - Power

The input for the PID control is the value reported by the PV channel 1.

The Set point uses the constant set up in channel 2.

- Start/Stop: If selected, a function key can be used to start & stop the PID control.
- Bidirectional: Select this for heating & cooling.
- Reverse: Do not select (This is for cooling only).
- Hysteresis: This is used for switching between heating & cooling outputs.
- Tuning Parameters: These values determine how fast the target set point is reached and how much overshoot occurs. It is best to run the Auto Tune function and then make any adjustments, if necessary.

Note: Auto Tune and Manual tune functions are assigned to function keys in the Screens menu.

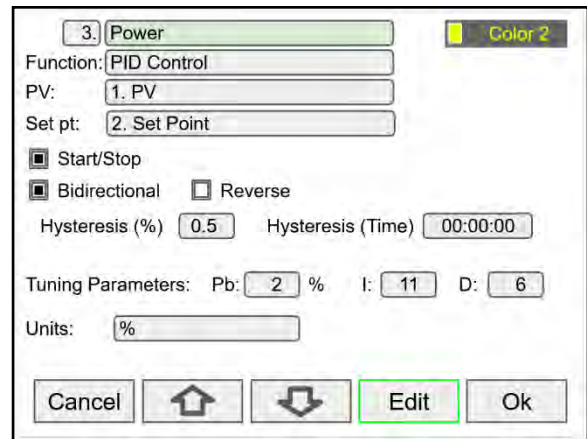

Channel 4: PWM Heating Control

Channel 4 is set up as the Pulse Width Modulation (4. PWM Heat) heating control channel. This channel provides the signal to the actual hardware outputs:

- 1) Digital output or
- 2) Relay

Notes:

- 1) Do not select Reverse (used for cooling only).
- 2) The units must be ON/OFF or other logic units. Custom units can be set up.

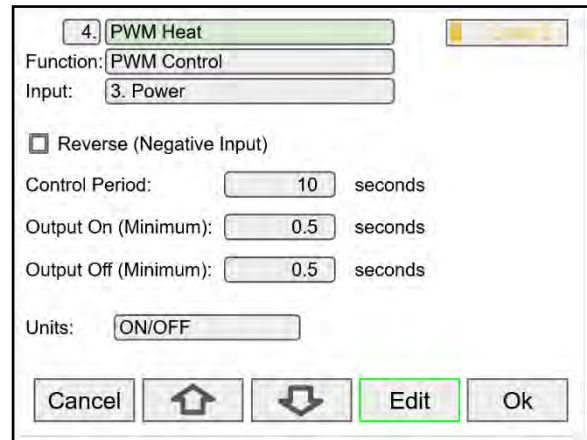

PID Control Heating Using Digital Output

In this example, digital output 1 (DO-1) takes the input from the PWM channel (4. PWM Heat); DO-1 drives a low voltage Solid State Relay (SSR 1). The SSR 1 in turn drives the heating element or a larger relay.

Digital Output

DO-1 SSR 1 Control

Input: 4. PWM Heat

Break: Digital Off

Invert Output

Cancel
⬆
⬇
Edit
Ok

Channel 5: PWM Cooling Control

Channel 5 is set up as the Pulse Width Modulation (PWM) cooling control channel. This channel provides the signal to the actual hardware outputs:

- 1) Digital output or
- 2) Relay

Notes:

- 1) Select Reverse for cooling.
- 2) The units must be ON/OFF or other logic units. Custom units can be set up.

5. PWM Cool Cooler 2

Function: PWM Control

Input: 3. Power

Reverse (Negative Input)

Control Period: 10 seconds

Output On (Minimum): 0.5 seconds

Output Off (Minimum): 0.5 seconds

Units: ON/OFF

Cancel
⬆
⬇
Edit
Ok

PID Control Cooling Using Digital Output

In this example, digital output 2 (DO-2) takes the input from the PWM channel (5. PWM Cool); DO-2 drives a low voltage Solid State Relay (SSR 2). The SSR 2 in turn drives the compressor or a larger relay.

Digital Output

DO-2 SSR 2 Control

Input: 5. PWM Cool

Break: Digital Off

Invert Output

Cancel
⬆
⬇
Edit
Ok

PID Controller: Block Diagram for Heating & Cooling Using Analog Outputs

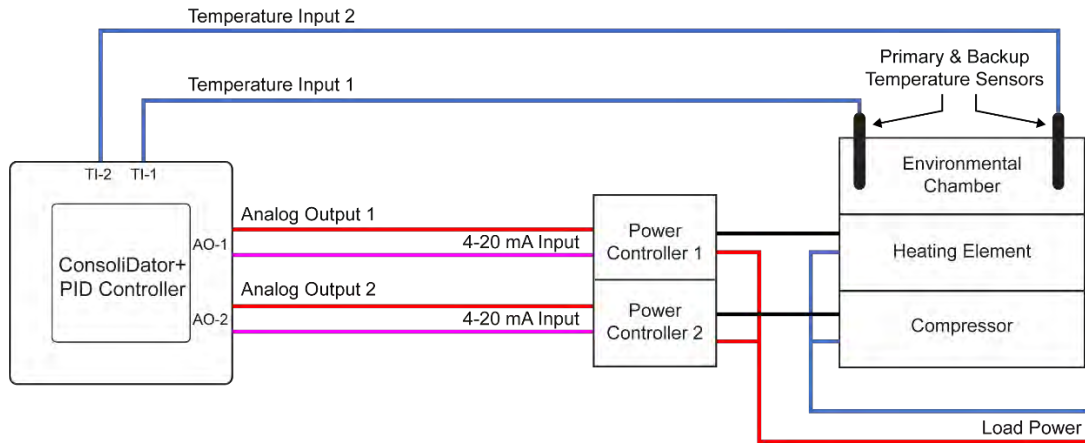

Notes:

- 1) The Switches function can be used to manually switch between primary and backup sensors, using a function key or digital input.
- 2) The Average function can be used to continuously average two sensors and to ignore a failed sensor, while continuing to use the good sensor.
- 3) If the primary sensor fails, the system can be configured to switch to the backup sensor automatically by setting an alarm to monitor the primary sensor and using the Switch function to get the PV from the backup sensor.

PID Control: Heating Using Analog Output

In this example the signal from the PID Control channel (3. Power) is used to control a 4-20 mA analog output (AO-1. Heating Control). The analog output is connected to a power controller, which in turn drives the heating element.

Note that channel (3. Power) is scaled to output 4-20 mA for 0 to 100% power.

4a: mA Output

AO-1:

Input:

Scale:	Input (%)	Output (mA)
1.	<input type="text" value="0.00"/>	<input type="text" value="4.000"/>
2.	<input type="text" value="100.00"/>	<input type="text" value="20.000"/>

Break: Slew Rate:

Minimum: Underrange:

Maximum: Overage:

PID Control: Cooling Using Analog Output

In this example the signal from the PID Control channel (3. Power) is used to control a 4-20 mA analog output (AO-2. Cooling Control). The analog output is connected to a power controller, which in turn drives the compressor.

Note that channel (3. Power) is scaled to output 4-20 mA for 0 to -100% power.

4b: mA Output

AO-2:

Input:

Scale:	Input (%)	Output (mA)
1.	<input type="text" value="0.00"/>	<input type="text" value="4.000"/>
2.	<input style="background-color: #d3d3d3;" type="text" value="-100.00"/>	<input type="text" value="20.000"/>

Break: Slew Rate:

Minimum: Underrange:

Maximum: Overage:

PID Control Configuration Using ConsoliDator+ Software

The easiest way to configure the ConsoliDator+ PID Controller is using the software. Most of the functions are set up using the Channels menu. The following images illustrate how to configure the controller using the following advanced user functions:

- Average function for two sensors
- Pulse Width Modulation (PWM) for SSR control
- Heating & Cooling PWM set up
- Switch function to quickly change target set point
- Switch function to select which RTD is used

Average Function Setup

The average function can be used to get a better process temperature or to provide the system with a backup sensor. By selecting "Exclude Failed Inputs" under the Average function setup, the good sensor is used to control the process. An alarm can be set up to alert the operator of a sensor failure.

- 1) Set up channel 1 to process the signal from RTD1.

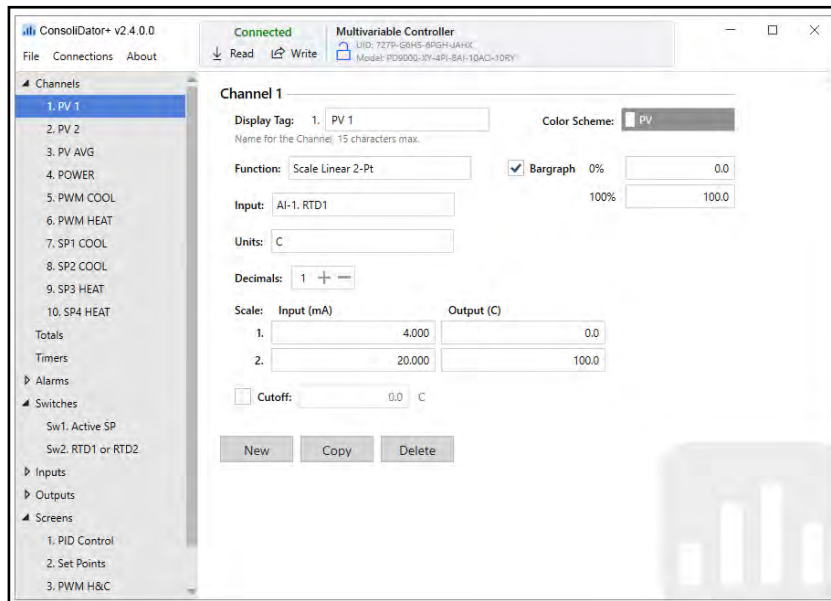

- 2) Set up channel 2 to process the signal from RTD2.

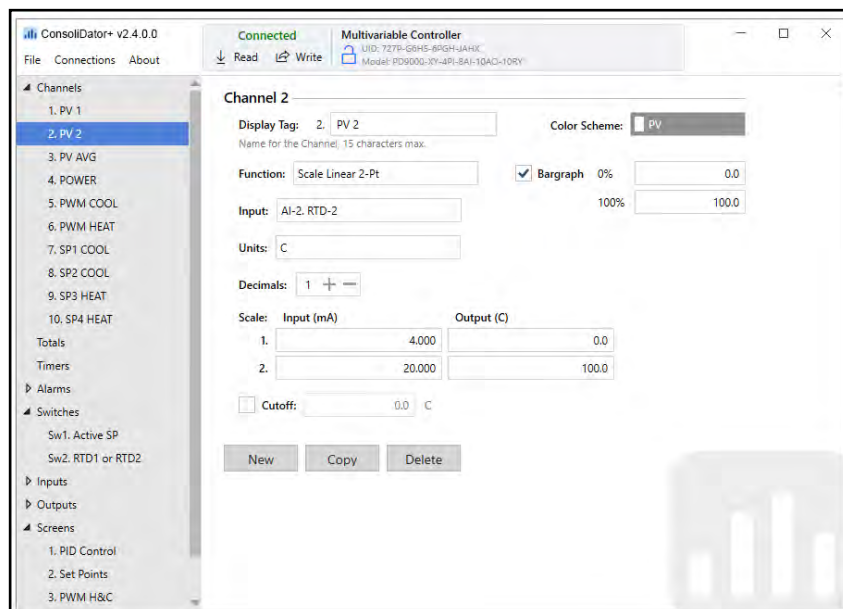

3) Set up channel 3 to average channels 1 and 2.

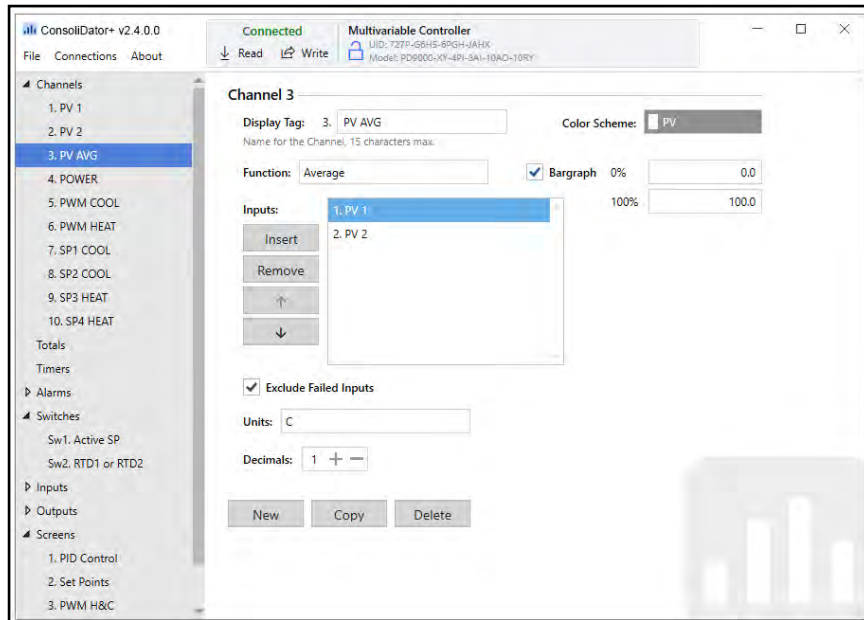

Configure PID Control Power Channel

The PID Control channel determines how the power is delivered to the output devices. The PID Control channel can be used as the input to the PWM channels for heating & cooling or as the input to the 4-20 mA analog outputs connected to power controllers.

The set point value is selected using the Switch function, the setup for the set points and how to switch them is shown below.

Note: The set points and Switch function must be set up before setting up this channel, otherwise use a constant as the set point to begin.

- Select Start / Stop to manually control the PID process.
- Select Bidirectional for heating & cooling applications.
- The tuning parameters are automatically updated after running the Auto Tune PID function using the function keys.
- Manual tuning can be done using the function keys.

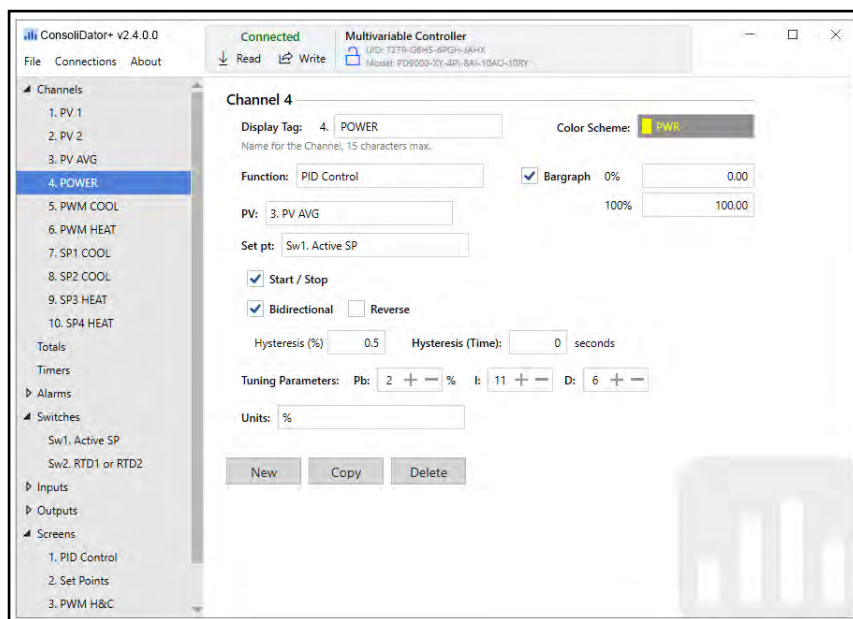

Configure PWM Control Heating Channel

The PID Control power channel is used as the input for the PWM heating channel. Do NOT select Reverse for heating applications. This channel is used as the input to the digital output (DO-1), which in turn drives a Solid State Relay (SSR1) providing power to the heating element.

IMPORTANT

- The units must be ON/OFF or other logic units.

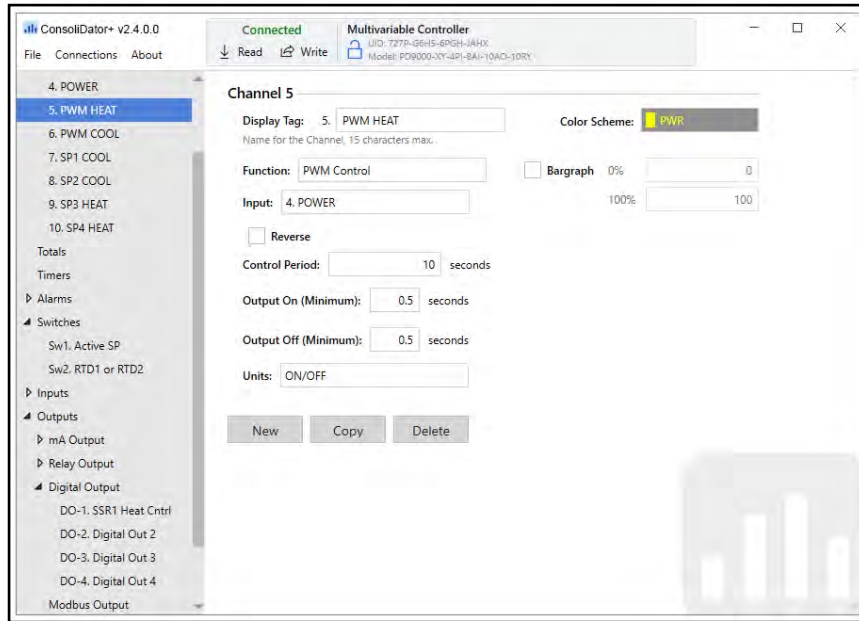

Configure PWM Control Cooling Channel

The PID Control power channel is used as the input for the PWM cooling channel. **Reverse** must be selected for cooling applications. This channel is used as the input to the digital output (DO-2), which in turn drives a Solid State Relay (SSR2) providing power to the compressor.

IMPORTANT

- The units must be ON/OFF or other logic units.

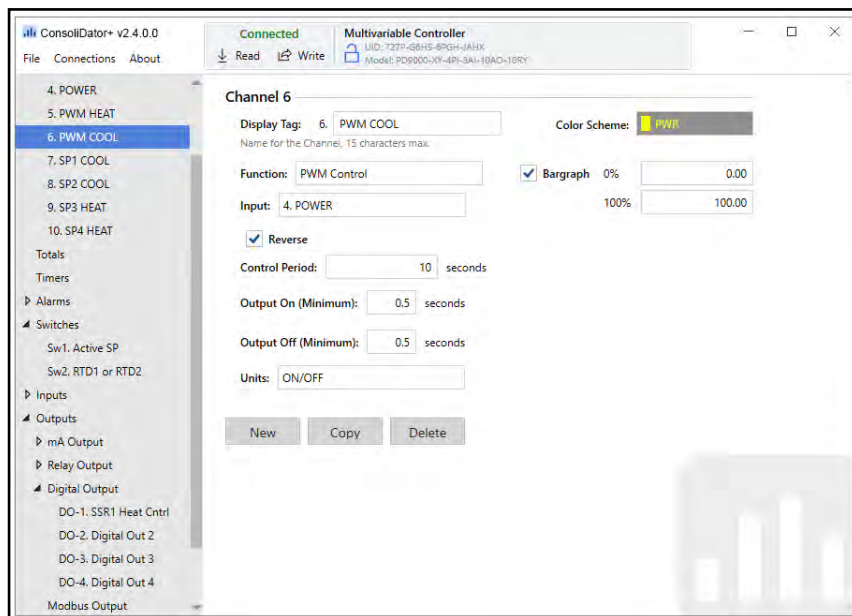

Configure Set Point Channels

Set points 1 – 4 are configured the same way.

- Display Tag: Description
- Function: Math > Constant
- Units: Select according to the PV being used
- Decimals: Select number of decimals
- Value: Enter initial value, this can be changed with function keys
- Color Scheme: Select colors to display set point

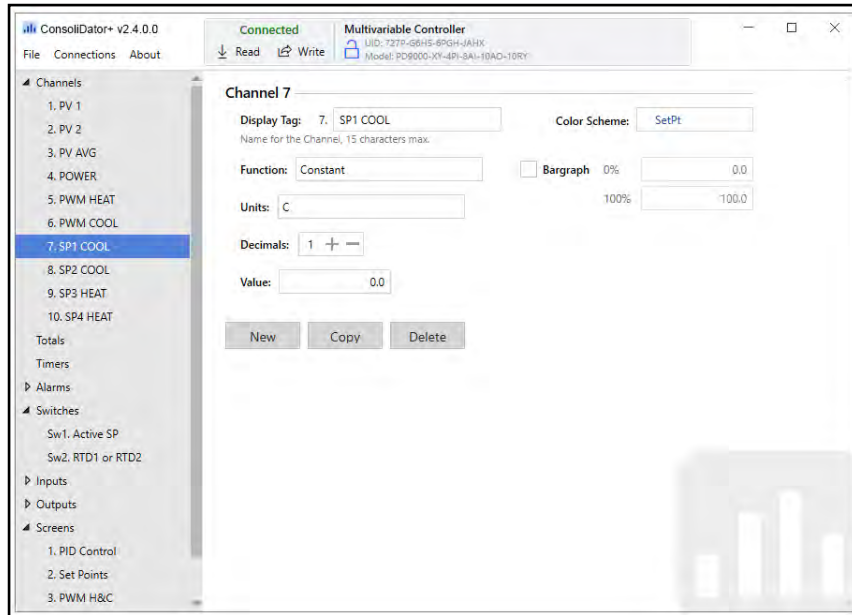

Configure the Switches Function

Switch 1 tag: Active SP

A four-way switch is used to select four set points, previously configured using constants and the input to channels.

A function key is set up in the Screen menu to select SP1 through S

P4. Additional actions can be selected when the switch moves through the various positions.

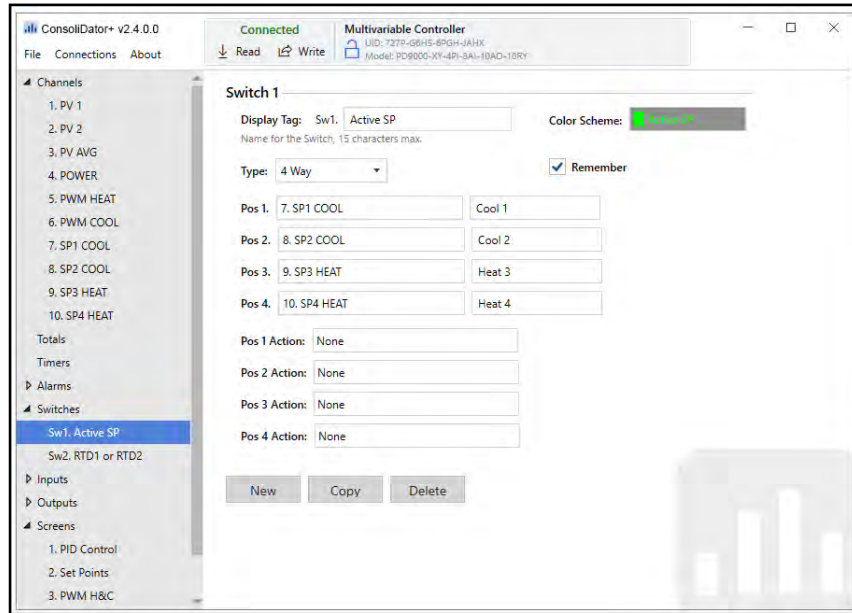

The Switches function can be used to manually switch the active sensor.

A function key can be assigned to control which sensor is used.

In this setup, the internal horn sounds every time the sensors are switched.

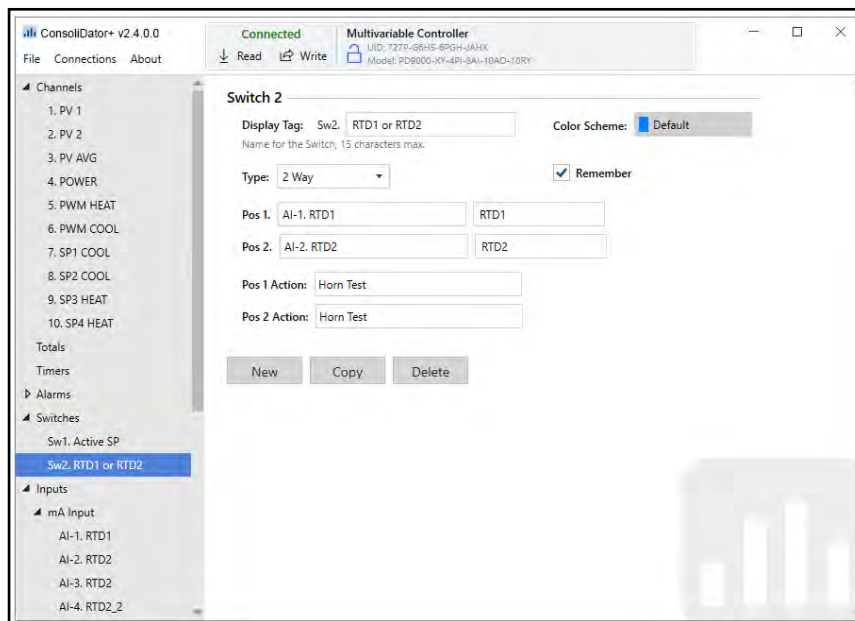

Configure the Digital Outputs

The digital outputs are controlled by the PWM channels and are connected to the SSRs.

DO-1 is used to drive SSR1, which provides power to the heating element.

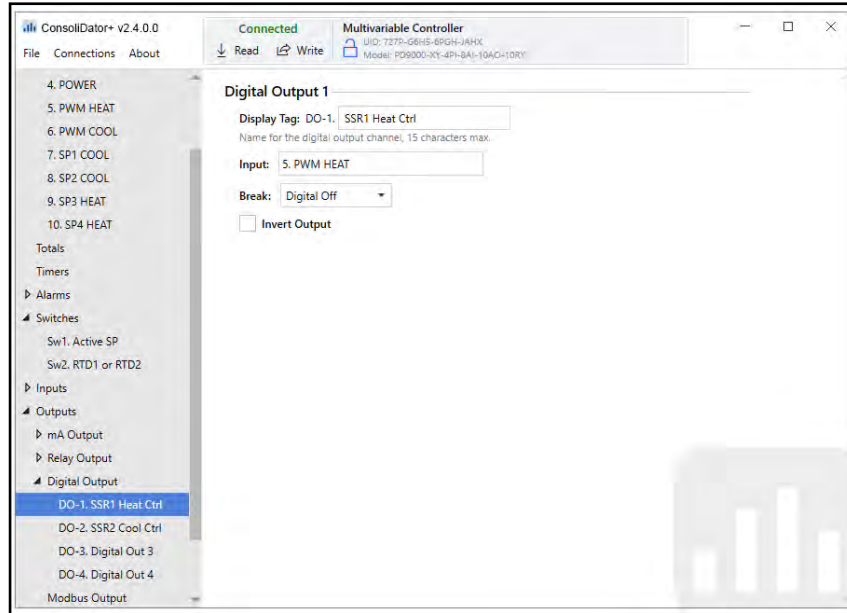

DO-2 is used to drive SSR2, which provides power to the compressor.

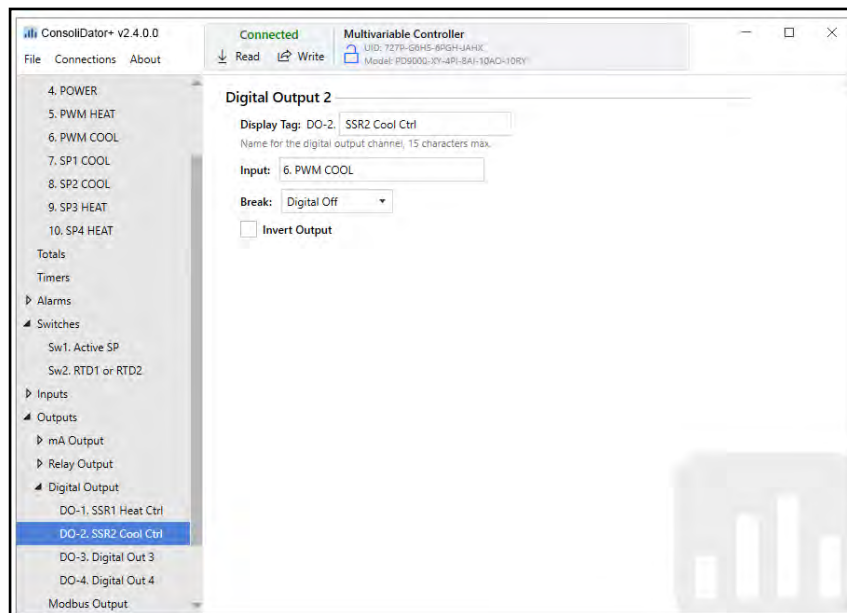

Configure the PID Control Screens

The screens are configured according to the application. There are three values needed for monitoring the PID control process.

- PV
- Set Point
- % Power

The function keys can be assigned as desired.

- F1: Manual Tune
- F2: Auto Tune
- F3: Active Set Point controlled with Sw1
- F4: Next Screen

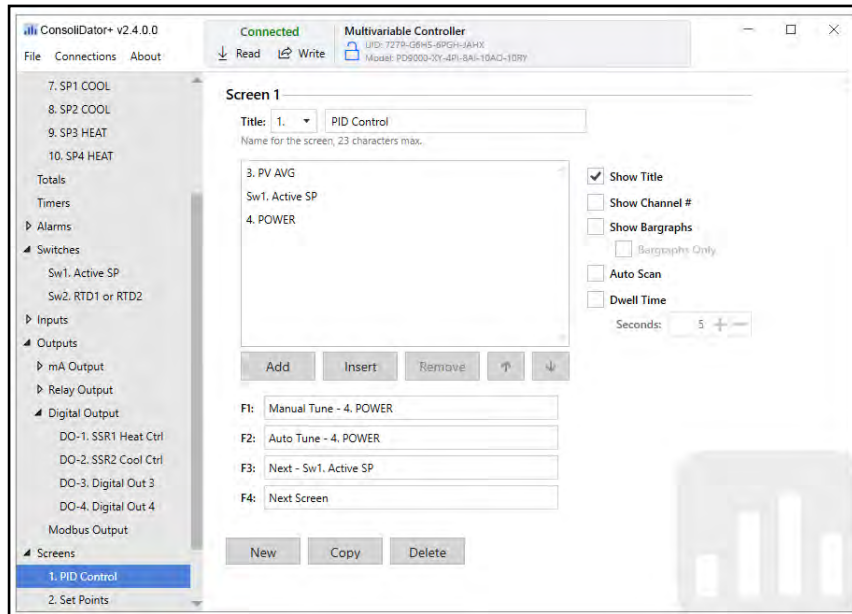

This screen is used to display the set point configured using channels 7 – 10.

The function keys are assigned as follows:

- F1: Start / Stop the PID control process
- F2: Quick access to changed SP1
- F3: Quick access to changed SP2
- F4: Next Screen

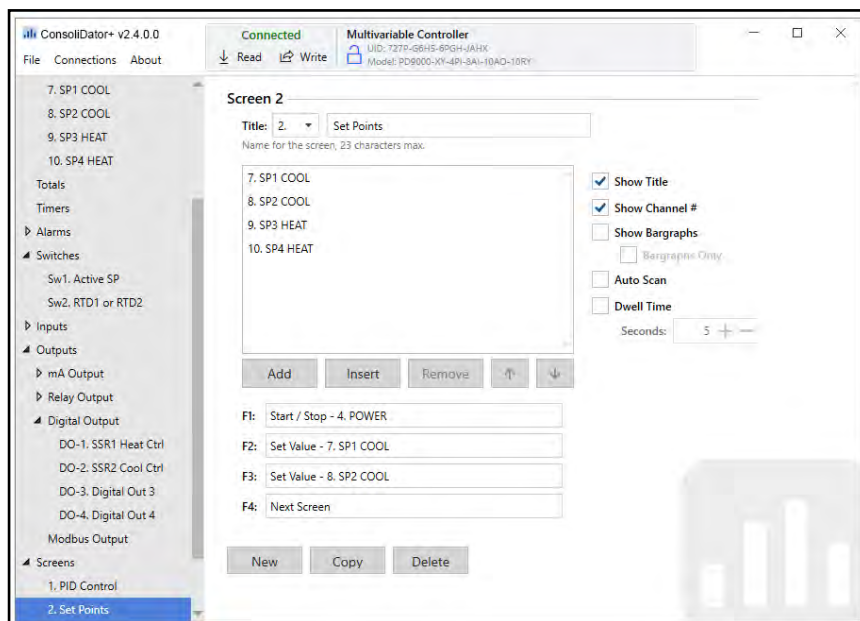

This screen is used to display the PV and the status of the PWM channels.

The function keys are assigned as follows:

- F1: Quick access to changed SP3
- F2: Quick access to changed SP4
- F3: Switch between RTD1 and RTD2 sensors
- F4: Next Screen

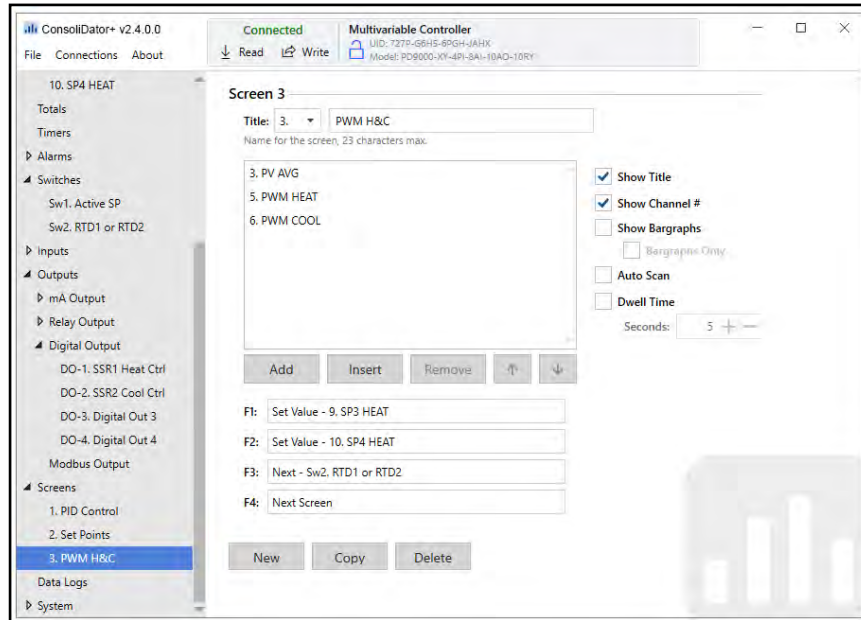

PID Control Screens

This is the main PID Control screen after power up. The Power channel displays the message STOPPED. The next screen has the function key to start the PID control.

- PV AVG: 23.3°C
- Active Set Point: 0.0°C
- % Power: STOPPED

Press the F4 key to go to the next screen and start the PID control process.

The function keys can be assigned as desired.

- F1: Manual Tune
- F2: Auto Tune
- F3: Next Set Point switched with Sw1
- F4: Next Screen

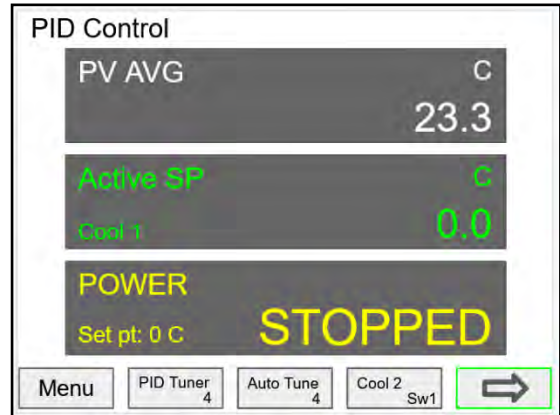

This is the Set Points screen.

- SP1: 0.0°C
- SP2: 10.0°C
- SP3: 65.0°C
- SP3: 85.0°C

Press the F4 key to go to the next screen and access the function keys for changing SP3 (Set 9) and (Set 10).

The function keys are assigned as follows:

- F1: Start – Press to start the PID control
- F2: Set 7 – Press to change SP1
- F3: Set 8 – Press to change SP2
- F4: Next Screen

Press the F4 key twice to go to the main PID Control screen.

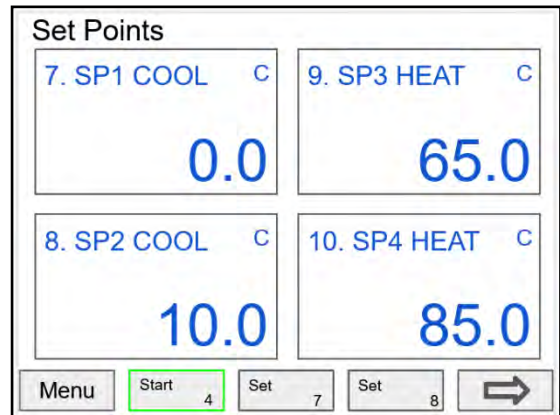

This is the main PID Control screen after pressing the Start key.

The Power channel outputs -100% indicating that is driving the compressor at full power.

- PV AVG: 23.3°C
- Active Set Point: 0.0°C
- % Power: -100.00%

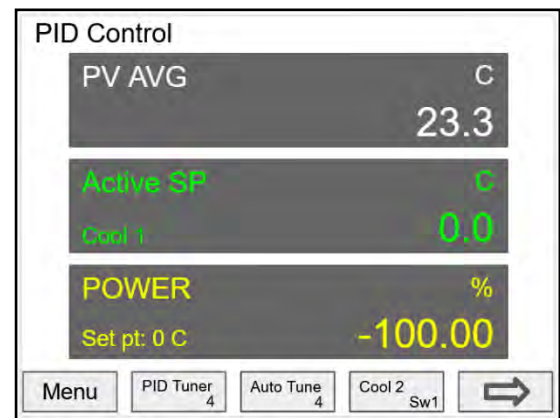

This is the PWM H&C screen, it shows the PV and the status of the heating and cooling channels.

- Power % negative: PWM Cooling
- Power % positive: PWM Heating
- Power % 0.00: Heating & Cooling are OFF

The Power channel outputs -100% indicating that is driving the compressor at full power.

- F1: Set 9 – Press to change SP3
- F2: Set 10 – Press to change SP4
- F3: RTD2 – Press to switch to RTD 2 sensor
- F4: Next Screen

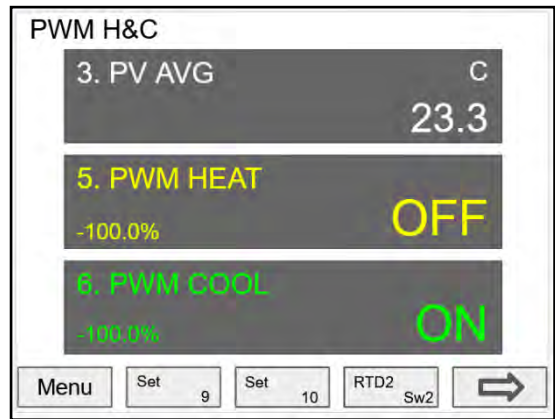

Open Channel Flow

The built-in math formulas in the ConsoliDator+ makes the setup of open channel flow applications an easy task. All you need to know is the type of device being used and the formula for calculating the flow rate using the head height.

The first thing to do is to create a channel for measuring the head height of the weir or flume. This example shows the setup for a 3" Parshall Flume with a maximum head height of 3 feet.

1. Head Height Colors 1
 Function: Scale Linear 2-Pt Bargraph
 Input: AI-1. Flume 1 Sensor 0% : 0
 Units: Feet 100% : 3.000
 Decimals: 3
 Scale: Input (mA) Output (Feet)
 1. 4.000 0.000
 2. 20.000 3.000
 Cutoff: 0.0 Feet

Buttons: Cancel, Home, Down, Colors, Ok

Scale the 4-20 mA input

2. Flow Rate
 Function: Parshall Flumes

Scale	Parshall Flumes
Math	V-Notch Weirs
Flow	Cipolletti Weirs
Compare	Rectangular Weirs
Measure	R-Weirs w/Contraction
Filter	
Control	
Relays	

Buttons: Cancel, Home, Down, Left, Ok

Select the type of weir or flume installed

2. Flow Rate Colors 1
 Function: Parshall Flumes Bargraph
0% : 0.000
100% : 5.428
 Formula: $Q = K H^n$
 Constant K: 0.9920 (Q = cuFt/sec)
 Head: 1. Height Feet
 Exponent: 1.547
 Units: cuFt / sec Decimals: 3

Buttons: Cancel, Home, Down, Edit, Ok

Enter the constant K (for Q = cuFt/sec), the channel used for measuring the head height and the specified exponent. Select the flow rate units. The Controller calculates the flow rate in the specified engineering units. The units can be changed at any time without making any other changes.

Setup Totalizer Based on Flow Rate

T1. Total Flow Colors 1
 Input: 1. Flow Rate Bargraph
 Units: CuFt 0% : 0
100% : 1000000
 Decimals: 0
 Count Down
 Allow Negative
 Preset Value: 0 GAL
 Roll-Over: 0 GAL
 Non-Resettable

Buttons: Cancel, Home, Down, Edit, Save

Setup Screen to Monitor Open Channel Flow

1. Open Channel Flow

- 1. Head Height
- 2. Flow Rate
- T1. Total Flow
- AI-1. Flume 1 Sensor
- Add ...

Show Title
 Show Channel #
 Show Bargraphs
 Bargraphs Only
 Auto Scan
 Dwell Time
 Seconds: 5

Buttons: F1, F2, F3, F4, Home, Down, Edit, Delete

Setup Totalizers

The totalizers are setup the same way as the channels. The rate from an analog or pulse input channel is integrated over the specified time unit to generate an accumulated total that can be configured to count up or count down. Each total can be configured as “non-resettable”, which means the total reset functions are not available for it.

The pulse inputs can be either integrated from a rate channel or they can be directly totalized based on the pulse count and K-Factor value; this is the most accurate method because every pulse is counted.

***Note:** The non-resettable function can be disabled by the user at any time, after unlocking a password-protected controller.

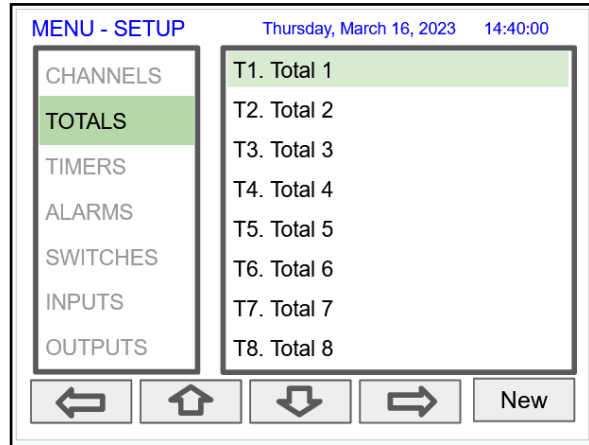

Setup Total with Rate Source

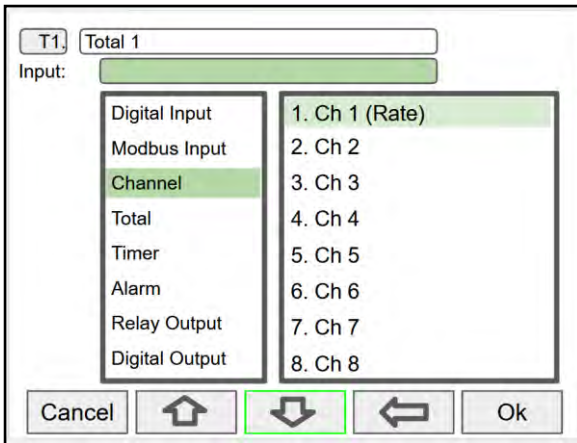

Select the rate input channel for the total and press **Ok**.

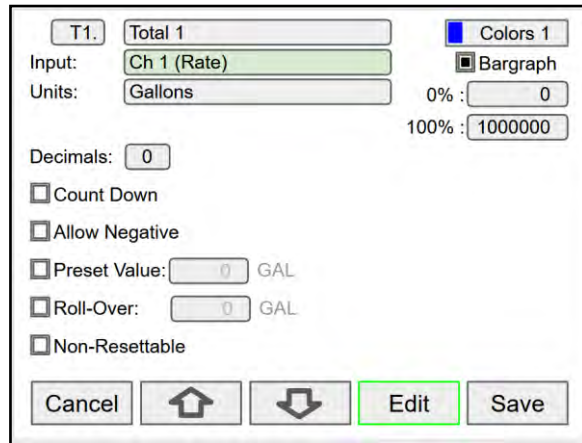

Select total units, count up or down, enter preset and roll-over values, and select non-resettable if required. After pressing **Save**, press **Yes** to reset the total to the preset value.

Setup Total with Pulse Input Source

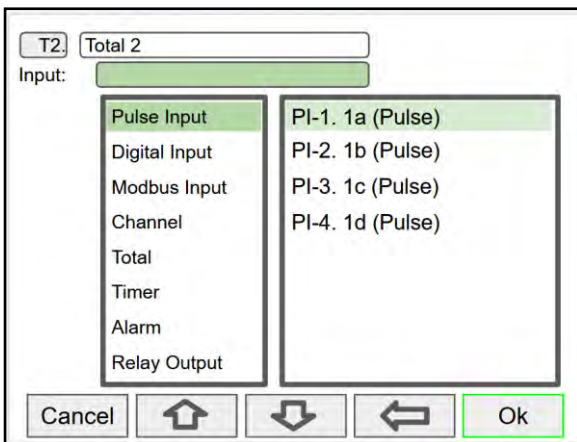

Pulse inputs can be totalized directly without the need to create a rate channel.

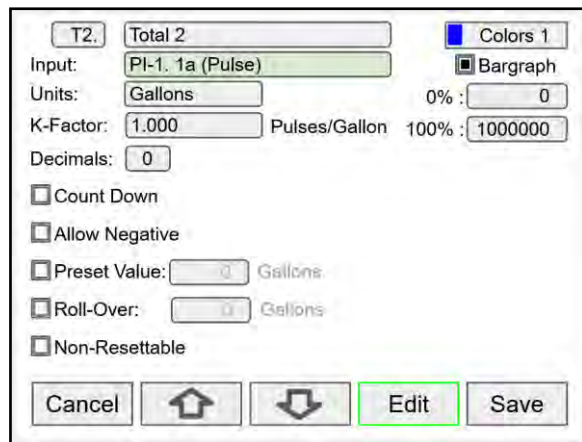

Select the units and enter the K-Factor provided by the flow meter manufacturer.

Setup Accumulated Total (Triggered)

Selecting a total as the input for a new total enables the *Mode* menu: Totalizer, Previous Total, Daily Total, and Grand Total selections.

The *Totalizer* mode can be used to add the input total to the new total, when a trigger is activated. The trigger can be a digital input, a Modbus input, or any event selected.

Setup Previous Total

The previous total is saved just before the input total is reset. The date & time when the total was reset is saved.

Multiple previous totals can be saved by using a previous total as the input for a new total. Link previous totals to maintain a history of total resets.

Setup Daily Total

The daily total is automatically reset every day at midnight.

The daily total can be the input to a previous total to save the previous day total. Link previous daily totals to maintain a history of daily totals.

Setup Grand Total

T6.	Grand Total 1	<input checked="" type="checkbox"/> Colors 1
Input:	T1. Total 1	<input checked="" type="checkbox"/> Bargraph
Mode:	Grand Total	0% : 0
Units:	Gallons	100% : 1000000
Decimals:	0	
<input type="checkbox"/> Count Down		
<input type="checkbox"/> Allow Negative		
<input type="checkbox"/> Preset Value:	0 Gallons	
<input type="checkbox"/> Roll-Over:	0 Gallons	
<input checked="" type="checkbox"/> Non-Resetable		
<input type="button" value="Cancel"/>	<input type="button" value="Home"/>	<input type="button" value="Down"/>
<input type="button" value="Edit"/>	<input type="button" value="Save"/>	

The grand total takes the input from another total and it is not affected by resets of the input total. It is normally set up as non-resettable.

Setup Timers

Up to 30 timers can be set up to control and monitor various processes. The timers can be triggered by any input or output, such as an analog input rising above a certain threshold or a digital input going from low to high.

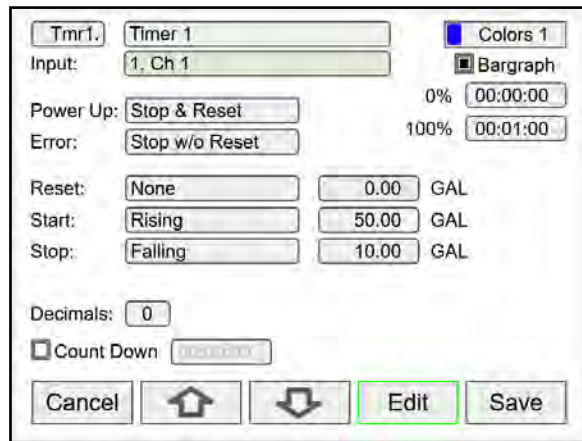
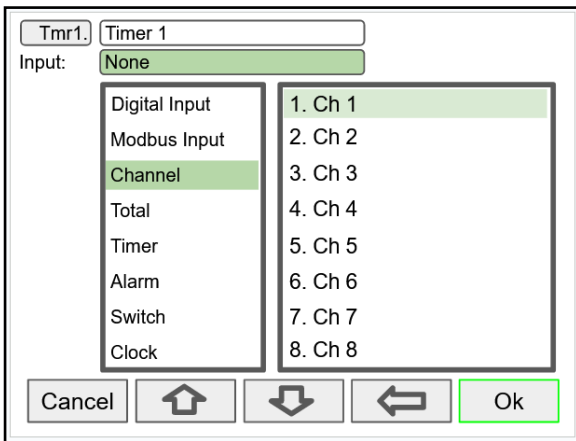
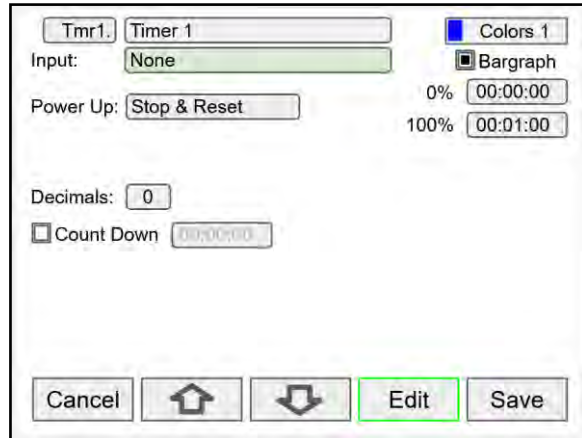
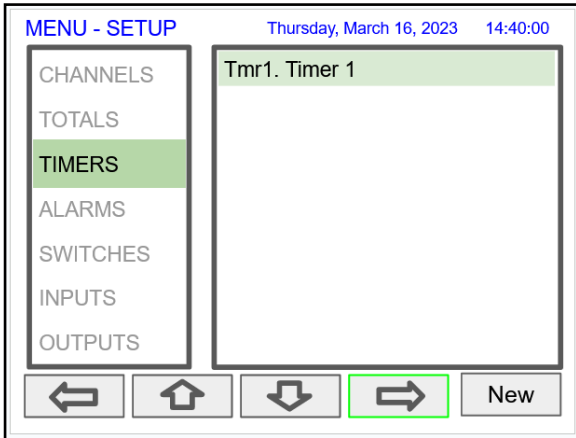

Additional Inputs to control the timer:

- mA Input
- Pulse Input
- Relay Output
- Digital Output
- Modbus Output

Timer Automatic Actions

The automatic timer actions are:

- Power Up: Timer action on power up
- Error: Timer action when an error is detected
- Reset: Event that causes the timer to reset
- Start: Event that triggers the timer to start
- Stop: Event that causes the timer to stop

Timer Function Keys & Digital Inputs

The function keys and digital inputs can be used to start, stop, and reset the timers, regardless of the automatic actions selected.

Time Format

The time format is hh:mm:ss with 0 decimals selected. If decimal is other than 0, the time is displayed in seconds with the number of decimals selected.

Count Down Timer

Select count down and enter the starting time count.

Timer Bargraph

The bargraph scaling follows the time format selected based on decimal point.

Timer Colors

Select the colors for normal and alarm conditions.

Timer Alarms

Alarms can be set up to trigger on timer values, counting up or down. Go to the *Alarms* menu and select a timer as the source for the alarm.

Setup Alarms

The system is capable of handling up to 64 alarms; they can be driven by a single channel, multiple channels, digital inputs, time interval, or a combination of other alarms into logic AND & logic OR alarms. Set and reset point values determine if it is a high or low alarm and the dead band. Alarms can set up as latching or non-latching (automatic) with on and off time delays.

1. Tag: 15-character user-defined
2. Type: Select alarm type
 - Single Source
 - Multi-Source
 - Time Interval
 - Alarms OR
 - Alarm AND
 - Day & Time
3. Input: This will depend on type selected
 - Type: Single or Multi-Source
 - Digital
 - Modbus
 - Channel
 - Total
 - Timer
 - Type: Alarms AND & OR
 - Inputs: Other alarms
4. Range Alarm: Enabling the Range Alarm changes 'Set Pt' and 'Reset' to 'Lower' and 'Upper'. The channel enters an alarm state when the process variable falls within this range.
5. Colors: Normal and alarm conditions
6. Sound Horn: Internal buzzer and relay
7. Alert!: Display alert message on Menu key
8. Automatic: Resets when PV crosses the reset point
9. Ack Anytime (Latching): Ack alarm anytime
10. Break: Alarm status when sensor/comm. break is detected (e.g. Input < 0.01 mA)
 - Alarm On
 - Alarm Off
 - Stay (Maintain the state before the break)
11. On/Off Delays

Multi-Source Alarm
 This alarm type behaves as a logic OR; if any of the sources crosses the set point, the alarm goes on. If the first source is digital (logic), only sources with digital value (on = 1, off = 0) are available for selection. If the first source is a PV channel or timer, digital inputs can be added as source.

Latching & Non-Latching Alarms		
Reset (Ack)	Ack Anytime	Automatic
Auto & Manual	X	X
Auto Only	0	X
Manual Only	X	0
Manual Only After Cleared	0	0

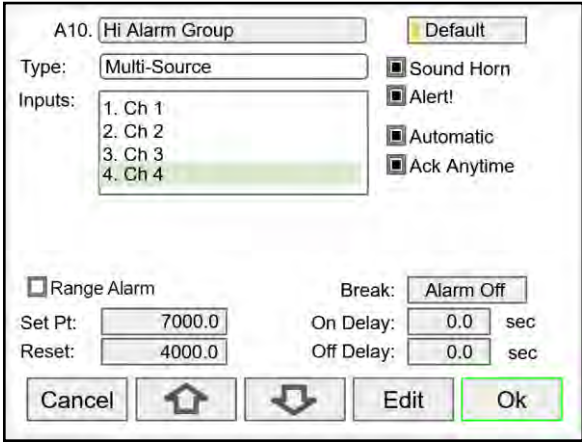

Automatic reset and Ack anytime
 Relay assigned to Horn activates on alarm condition

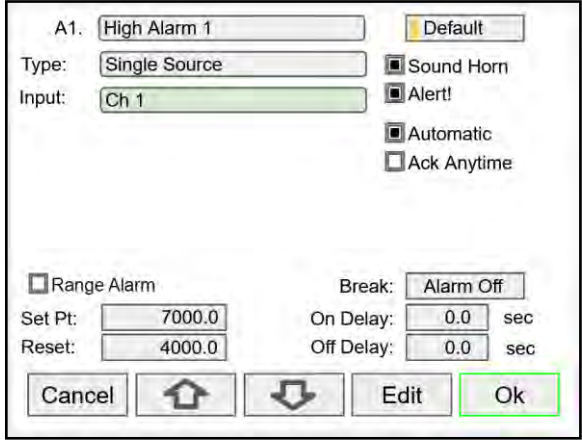

Automatic only: Alarm resets automatically at the reset point

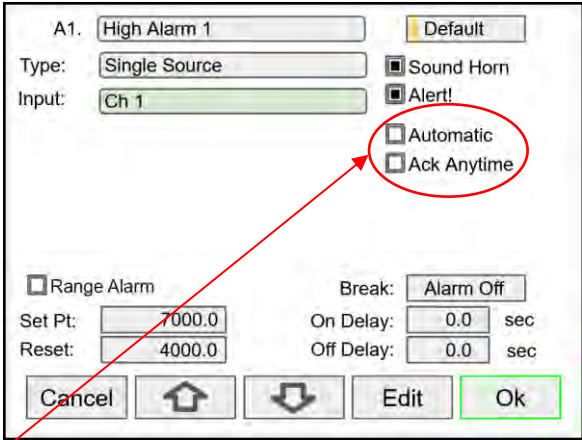

Latching: Acknowledge only after the alarm condition has cleared
 Manual Ack (Latching): Select Ack Anytime only

Logic OR Alarm

The inputs for the logic OR alarm are any existing alarms, regardless of the source or type.

Any active alarm in the group triggers the OR alarm. The OR alarm can be used as a summary alarm.

A13. Hi Alarm OR [Default]

Type: Alarm OR

Inputs: 1. High Alarm 1, 2. High Alarm 2, 3. High Alarm 3, 4. High Alarm 4

Break: Alarm Off

On Delay: 0.0 sec

Off Delay: 0.0 sec

Buttons: Insert, Home, Down Arrow, Edit, Ok

Logic AND Alarm

The inputs for the logic AND alarm are any existing alarm, regardless of the source or type.

All alarms in the group must be active to trigger the AND alarm.

A14. Hi Alarm AND [Default]

Type: Alarm AND

Inputs: 1. High Alarm 1, 2. High Alarm 2, 3. High Alarm 3, 4. High Alarm 4

Break: Alarm Off

On Delay: 0.0 sec

Off Delay: 0.0 sec

Buttons: Insert, Home, Down Arrow, Edit, Ok

Logic NOR & NAND Alarms

To create a NOR alarm, select an existing OR alarm and apply the **Not** function available during Setup – Edit.

The same applies to the NAND alarm. Any input alarm can be inverted (Not) to create a specialized alarm logic.

A15. Hi Alarm NOR [Default]

Type: Alarm OR

Inputs: 13. Hi Alarm OR Not

Break: Alarm Off

On Delay: 0.0 sec

Off Delay: 0.0 sec

Buttons: Insert, Home, Not, Edit, Ok

Day & Time Alarms

The Day & Time alarm uses the system clock. You can choose to alarm every day, weekdays, or any day of the week at a selected time.

Choose how long the alarm should stay on and if manual acknowledge is allowed.

A16:

Type: Sound Horn
 Alert!

Day: Time:

On Time: seconds

Ack Anytime

Setup the Switches Function

The *Setup Switches* screen is used to create and configure the digital switches.

Press on the *New* key to create a new switch.

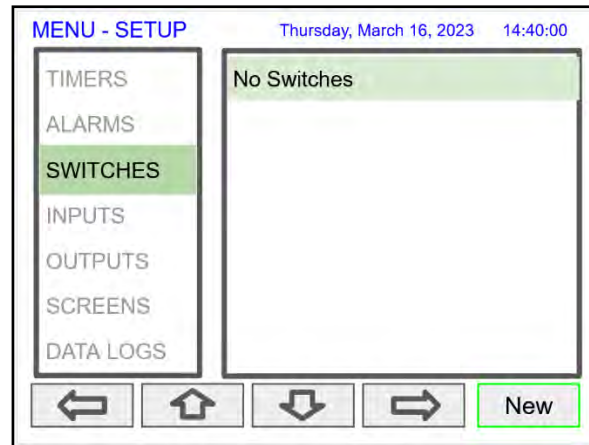

Setup 2, 3, or 4-Way Switch

The *Switches* function can be used to switch all types of inputs and outputs.

This screen shows the 4-20 mA outputs of two temperature sensors being switched with the digital switch Sw1.

- The output from Sw1 is used as the input for channel 1 to obtain the temperature reading from the RTD sensors.
- Assign a function key (F1-F4) or a digital input to control the digital switch Sw1 to route the signal into channel 1.
- The Position Action can be used to activate many user functions (e.g. Turn relays on/off, Horn Test, Modbus Input, etc).

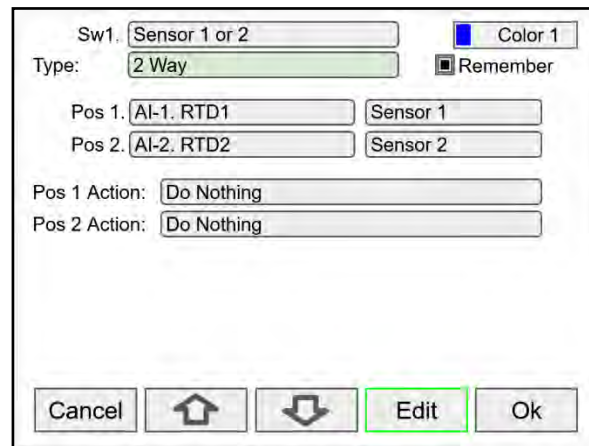

Setup a 4-Way Switch

This screen shows the setup of a 4-Way switch connecting the signal from four RTD transmitters.

- Every time the function key, controlling the switch, is pressed the switch advances to the next position.
- Relays have been assigned to turn on at different positions and to go to automatic mode at position number 4.

If no actions are needed, simply ignore these fields, and leave them as Do Nothing.

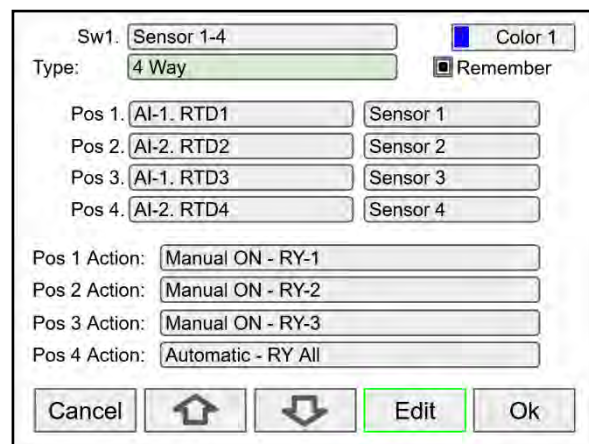

Setup HOA Switch

This screen shows the setup of an HOA switch to manage a wet well-filling pump based on well levels. A three way switch is configured to control each of the two pumps operating the system. To manage the pump alternation sequence, a pump alternation channel for wet well 1 was created and called "WW1 Pump Alt." The switch for pump 1 is titled HOA (HAND/OFF/AUTO) Pump 1. It will manage the first of the two alternating pumps.

The on-screen HOA switch is programmed with the following positions:

- Position 1: 1, or always on. This is labeled as "HAND" mode.
- Position 2: 0, or always off. This is labeled as "OFF" mode.
- Position 3: This position will direct the pumps to operate as called for by the pump alternation channel for wet-well 1.

The HOA switch will operate the pump based on the following positions:

- Position 1: Activated Relay 1 (HAND)
- Position 2: Deactivates Relays 1 (OFF)
- Position 3: Engages Automation Control Mode

A second switch can be configured for HOA control of pump 2.

HOA Pump Details Screen Example:

- Displays well level in Feet and Inches
- An Alert! message signaling that the pump has been manually turned off
- Indicates the HOA (Hand-Off-Auto) switch in the Off position
- Provides Pump 1 relay runtime and cycle count
- Prompts user to press the F3 key (AUTO) to switch to automatic control
- Bargraph for visual representation of the wet well level

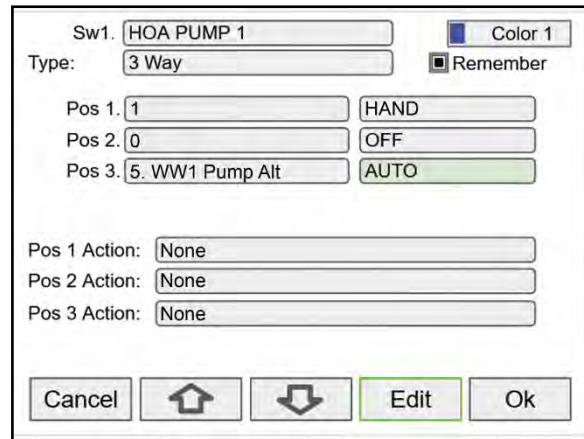

HOA Configuration Window

Remember

Select this feature to save the last setting on power down and start in the last position on power up.

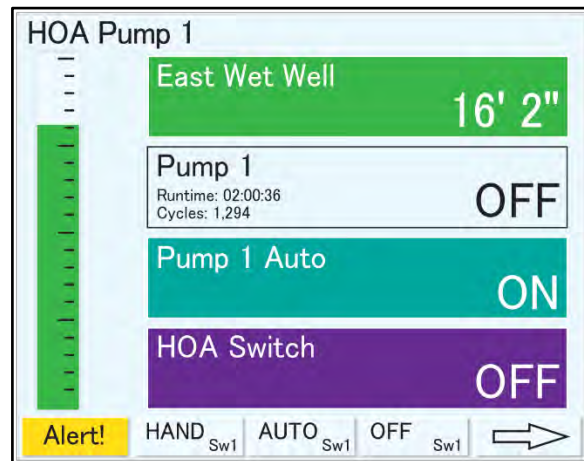

HOA Pump 1 Details Screen

Block Diagram for HOA Switch

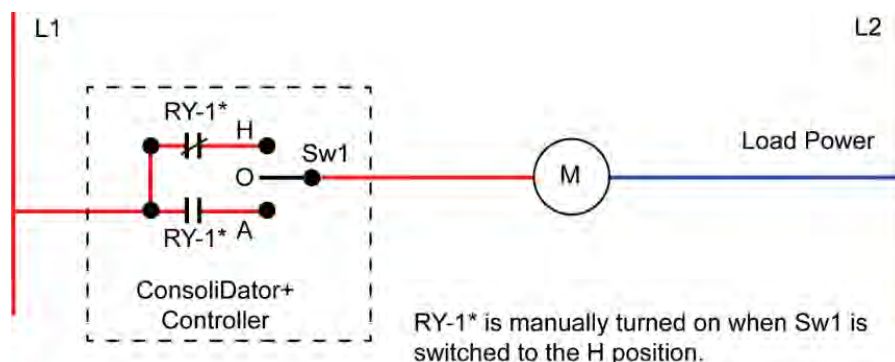

Configuration for HOA Switch Application Using the Software

Channel 1: Tank Level

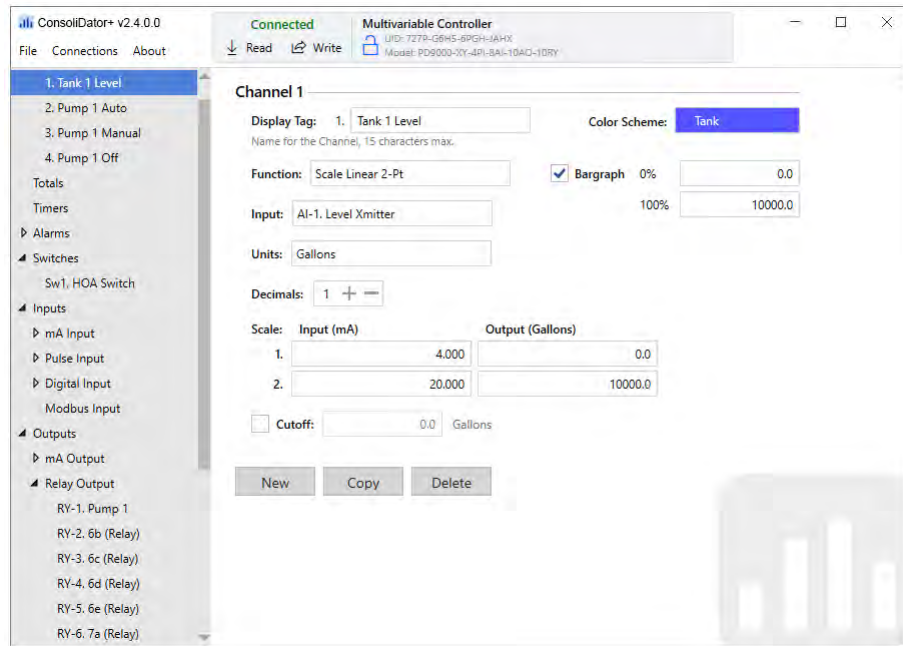

Channel 2: Automatic On / Off Control

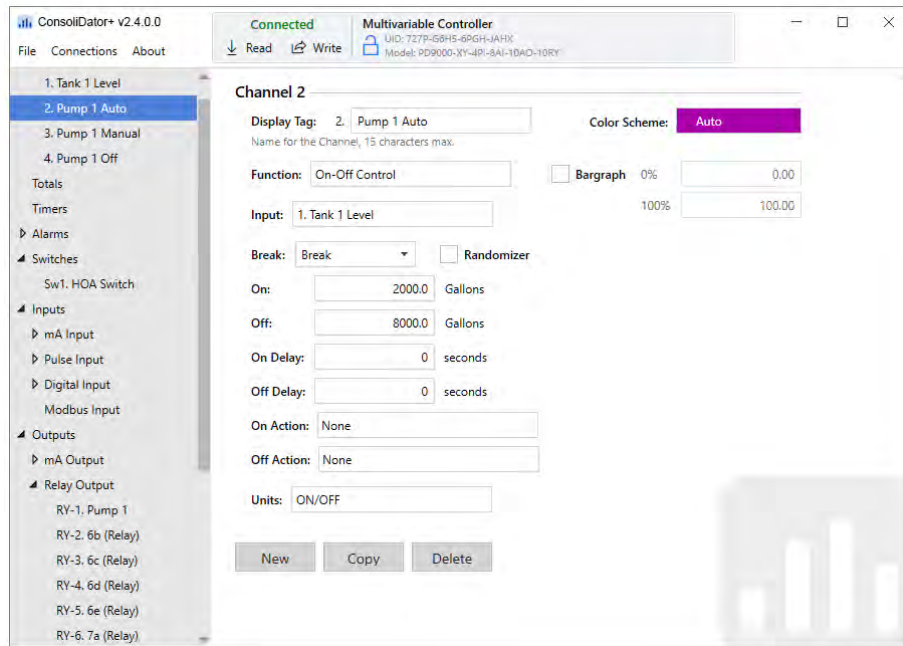

Channel 3: Manual Control

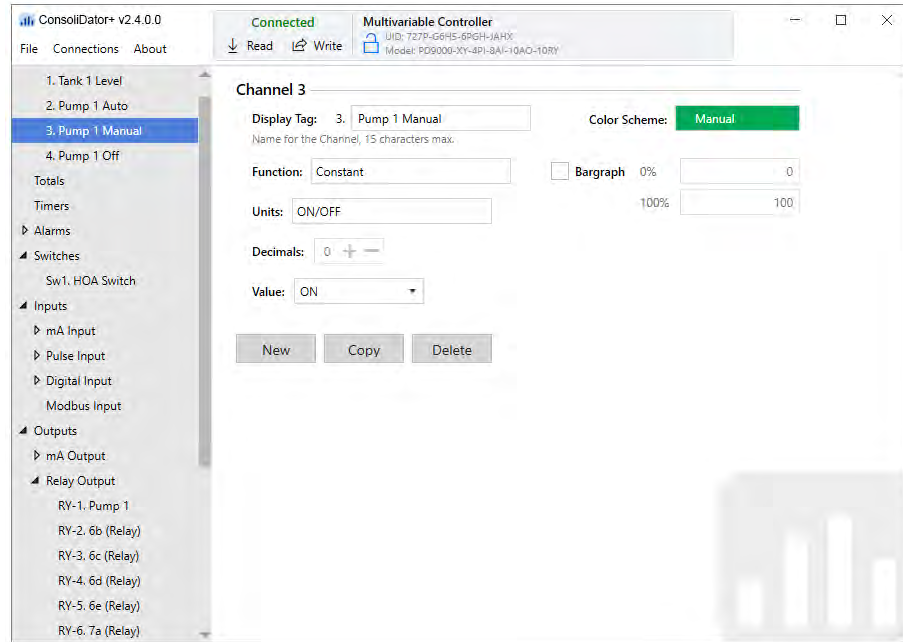

Channel 4: Off Control

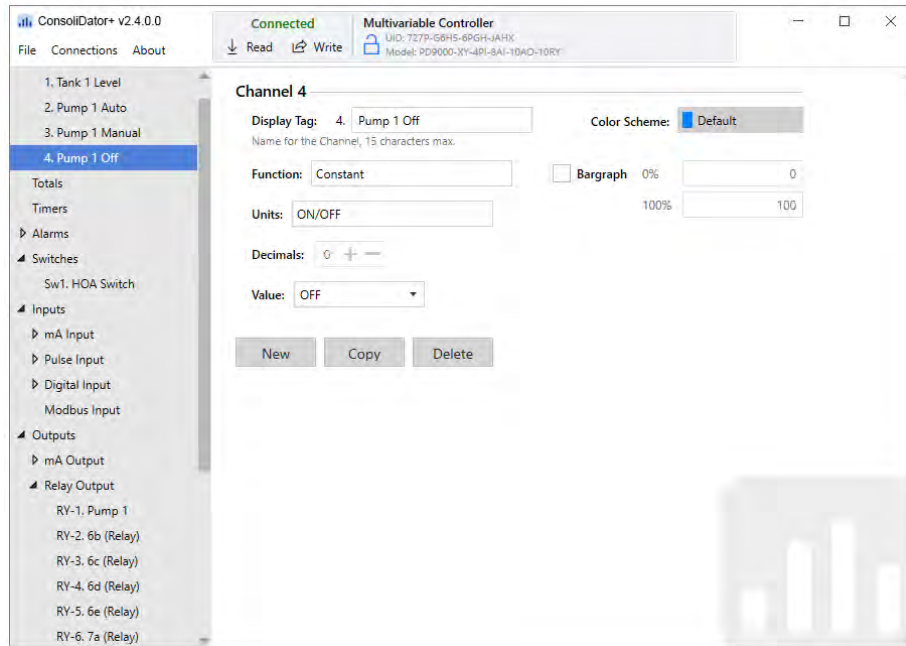

Setup HOA Switch

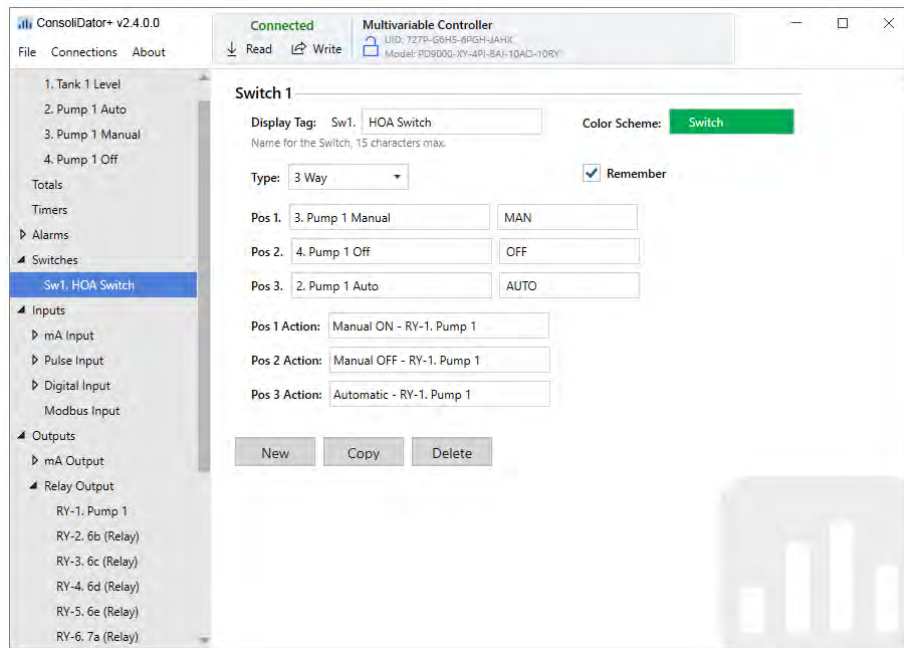

Setup HOA Relay

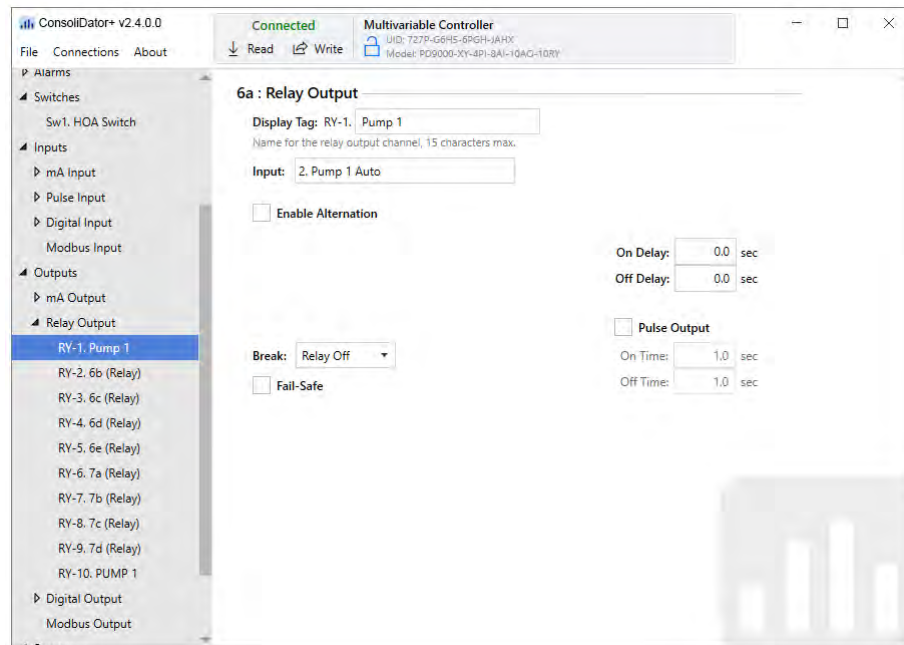

Setup HOA Screen

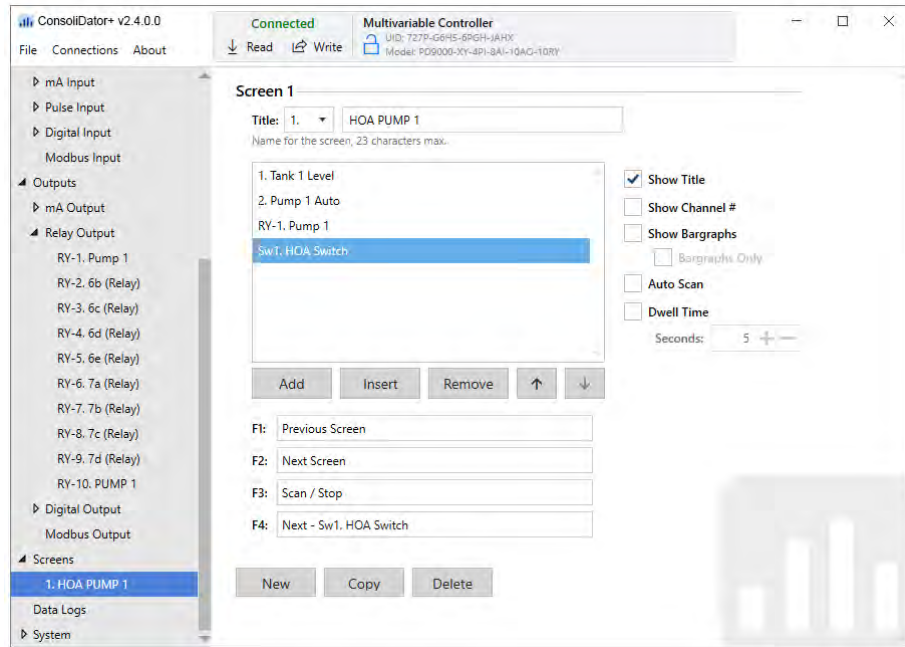

HOA Screen View

This screen shows the following:

- 1) Tank level in gallons
- 2) Alert! message indicating the pump has been turned off manually
- 3) HOA switch is the Off position
- 4) Pump 1 relay shows the runtime and number of cycles.
- 5) Press F3 key (AUTO) to switch to automatic control.

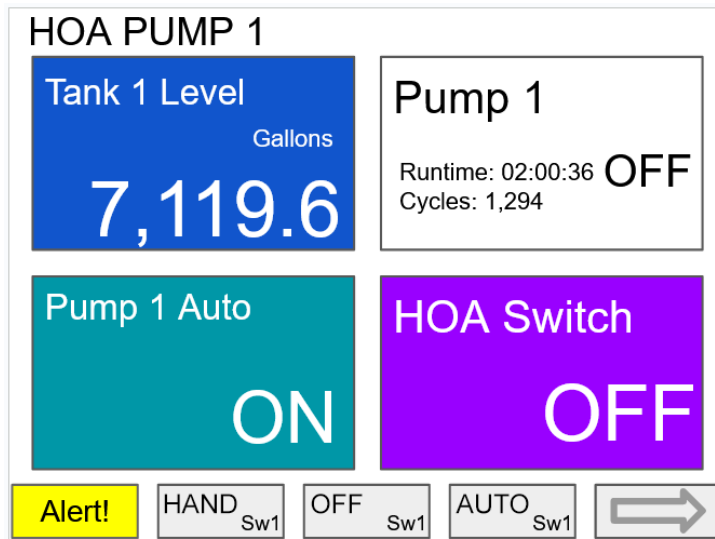

Batch Controller

The PDK9000-B1 Batch Controller Add-On feature, when ordered with the ConsoliDator+, will be activated at the factory. This Add-On feature can also be ordered for existing ConsoliDator+ units with firmware version 2.4 or greater at any time. The user will receive a key that can be entered into the ConsoliDator+ to unlock the Add-On feature. See page 139 for instructions on how to enable the *Add-On Features*.

The following screens show the menu items as seen with the batch controller feature enabled. This is a pay-for feature available in firmware version 2.4 & up, it can be purchased any time by contacting the sales department (sales@predig.com).

The batch process can be set up as single-stage or two-stage, manual or automatic.

Multiple batches can run at the same time or in sequence.

There are various actions that can be selected during the batch process; these actions can be used to control lights and horns, giving the operators valuable information about the process.

Up to 16 batches can be configured.

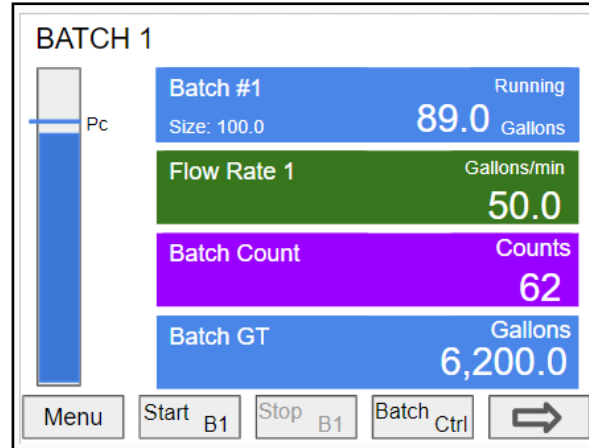

Setup Batches

The *Setup Batches* screen is used to configure the batch controller, assigning a user-defined tag, preset and pre-close values.

Batch Controller Features and Functions

- Enter a custom tag
- Select the color definition for text, background, and bargraph
- Select the Batch Input
- Enter the Preset value
- Select Pre-close, if required
- Select Automatic if required
- If Automatic batch is selected enter the time for the Start Delay of the next batch
- Select Auto Correct to make corrections for the next batch
- Select Count Down if required
- Select Actions to be performed during the batch operation:
 - Pre-Start Action
 - Start Action
 - Pre-Close Action
 - Finish Action

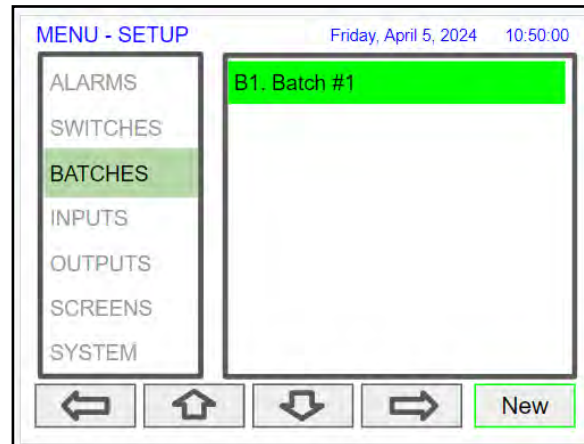

Setup Batch

The input for the batch is typically a total. Other process variables, such as channels setup for level, may be selected.

Enter the Preset and Pre-close values and other settings as shown on this page.

- **Preset:** Target batch size.
- **Auto Correct (default):** If the batch is not equal to the preset, the next batch automatically corrects the difference. It is important to maintain a stable flow rate at the end of the batch for the auto correct to work properly. Depending on the flow rate speed, the first batch might be slightly higher than the preset value.
- **Manual Correction:** Uncheck Auto Correction to require manual batch size corrections. To manually correct a batch, change the preset to adjust for the difference.
- **Pre-close:** Number of volume units prior to reaching the preset value.
- **Count Down:** The batch starts at the preset value and counts down to zero.
- **Automatic:** The next batch begins automatically after the programmed amount of time has elapsed.
- **Finish Action:** Another batch can be started when batch #1 is completed.

There are many actions that can be selected at the beginning, at the pre-close, and at the end of each batch.

The screenshot shows the 'Setup Batch' configuration window for 'Batch #1'. At the top, the batch name 'Batch #1' is highlighted in green, and 'Color 1' is selected with a blue square. The 'Input' field is set to 'T1. Total for Batch'. The 'Preset' is 1000.0 Gallons, and 'Pre-close' is 80.0 Gallons. The 'Automatic' setting is 00:02:00, and 'Start Delay' is 00:00:00. The 'Auto Correct' checkbox is checked, and 'Count Down' is unchecked. The 'Pre-Start Action' is 'Reset Total - T1. Total', 'Start Action' is 'Do Nothing', 'Pre-Close Act' is 'Do Nothing', and 'Finish Action' is 'Start - B2. Batch #2'. At the bottom, there are buttons for 'Cancel', 'Home', 'Back', 'Edit', and 'Save'.

Setup Batch Relays

The batch is controlled using one or two relays. The first relay is the main control relay which activates when the batch has been started, and de-activates when the preset amount is reached. The second relay is used as a pre-close if necessary for the application.

To setup a primary and pre-close relay for batch control, follow these steps:

1. Select the relay for the primary control action
2. Name the relay to identify it as a batch relay
3. Select the specific batch you want to assign this relay to (e.g. B1. Batch 1)
4. Enable the Position function and have the primary batch relay be Position 1
5. Hit Save when finished

You can then assign another relay as a pre-close by repeating the above steps and changing it to Position 2.

Setup Batch Count

The batch count can be set up using the batch as the input to a total. You can select to count the batch when it starts or when it finishes.

- Input: Batch #1
- Mode: Counts (Finish)
- Units: Count

Every time a batch is finished, the batch count increases by 1. This can be set up as non-resettable.

Setup Batch Grand Total

Set up the grand total using the batch as the input and select Grand Total as the Mode.

The Grand Total is automatically set as non-resettable.

Every time a batch is completed successfully, the batched amount is added to the grand total.

If the batch is stopped, the partial batch is not added to the grand total.

Note: The batch should be set up to count up for the grand total to work correctly.

For count down use the same total used for the batch as the input to the grand total and reset the total at the beginning of every batch.

Setup Batch Screen

The Screens menu allows the user to enter new batches and configure how the batches are displayed. Batches can be set up scroll automatically or manually. The function keys can be used to control the batch process and to navigate through the batch screens.

- Start Batch
- Stop Batch
- Pause Batch

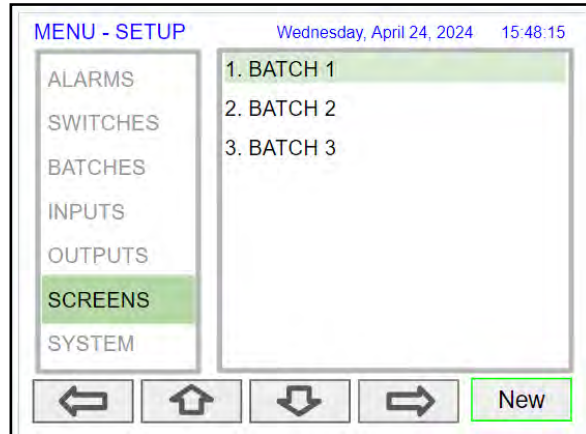

The batch screen can be set up to show the relevant information for the batch process.

- Running batch
- Flow rate
- Batch count
- Batch grand total

Show bargraph can be selected to see the batch progress and the pre-close point.

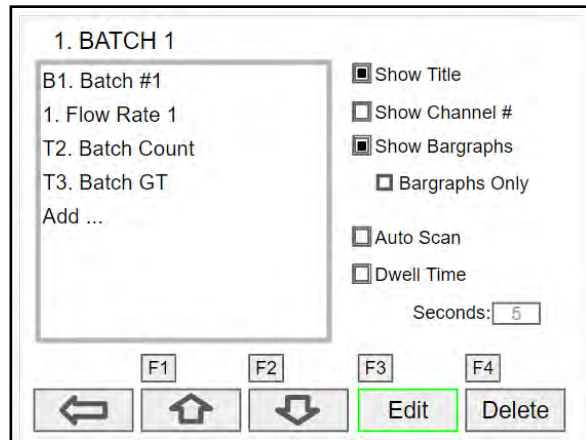

Batch Function Keys

The function keys can be assigned to any of the following batch functions:

- Batch Control
- Start
- Stop
- Start / Stop
- Start / Pause
- Pause / Stop
- Start Size
- Start Partial
- Set Preset
- Force On
- Force Off
- Force On / Off
- Force On / Auto
- Force Preclose
- Reset

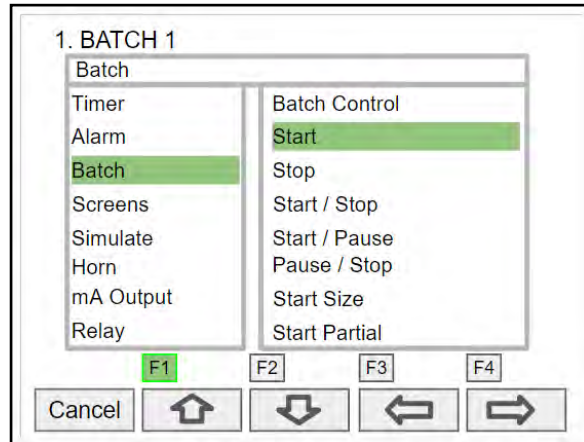

Batch Screen Examples

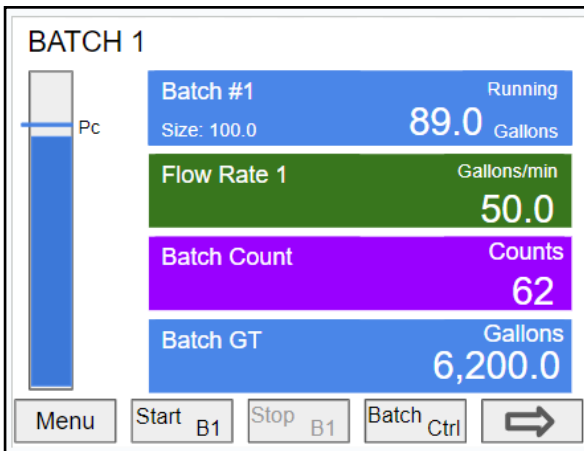

Batch screen showing the batch bargraph

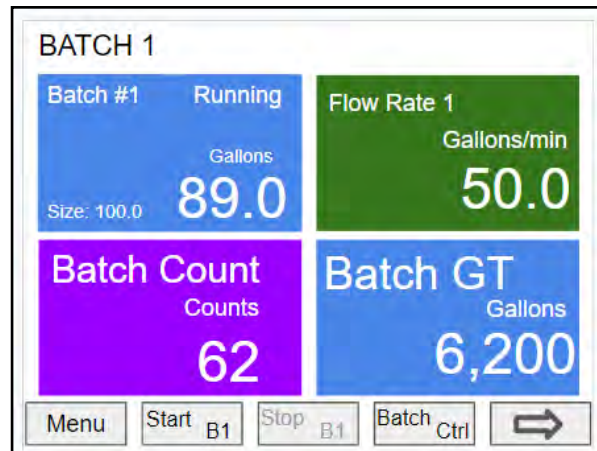

Batch screen without the batch bargraph

Batch Control Examples

Example #1: Simultaneous Batch Control of Two Ingredients and Ticket Printing

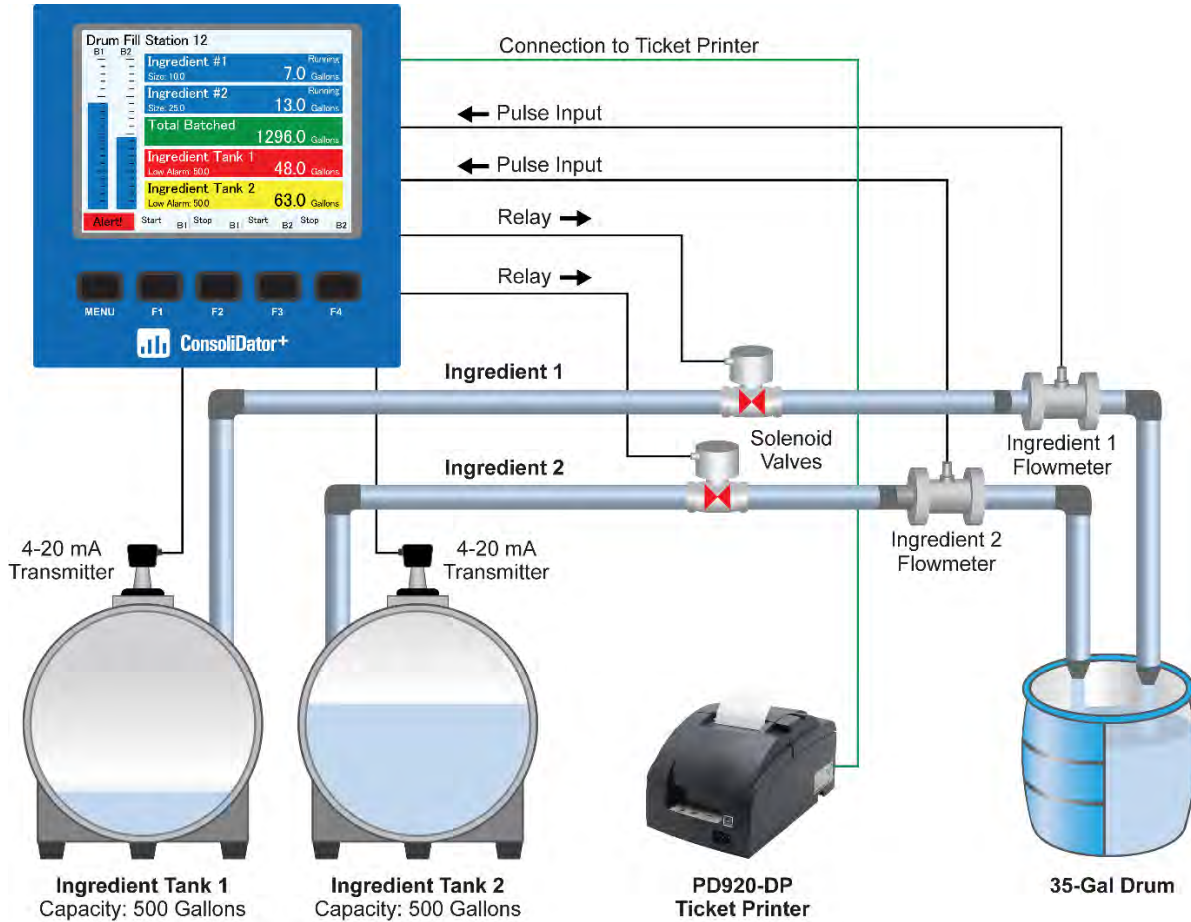

In this example, the ConsoliDator+ is performing two single-stage batches by reading the pulse inputs from the flowmeters and closing the solenoid valves when the batches are complete. The ConsoliDator+ is also displaying the level in the two source tanks from 4-20 mA level transmitters and indicating a low alarm situation for Tank 1. A ticket printer is connected to the ConsoliDator+ for printing critical information about the batch process. The batches can be started and stopped with the soft keys on the ConsoliDator+. The bargraphs provide a handy visual of how far along the batch is. Additional screens are available for displaying individual batches or other details

Example #2: Dual Stage Batch Control with Preclose & Preset

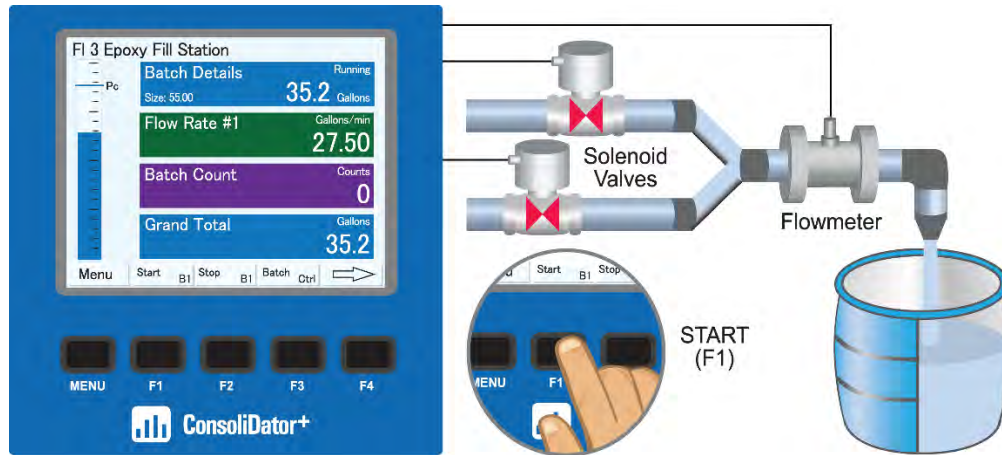

In this example, the ConsoliDator+ controls a full-flow valve and restricted-flow valve to provide more accurate batching of 55-gallon drums. A preset of 55.00 and preclose of 5.00 are set in the ConsoliDator+. The batch operation starts when the F1 (Start) button on the ConsoliDator+ is pressed. The full-flow valve closes at 50.00 when the preclose of 5.00 is reached. The restricted-flow valve remains open until the preset of 55.00 is reached, at which point the batch is completed. The bargraph provides a handy visual of how far along the batch is.

Example #3: Multiple (Different Size) Batches Run Simultaneously Displayed on Multiple Screens

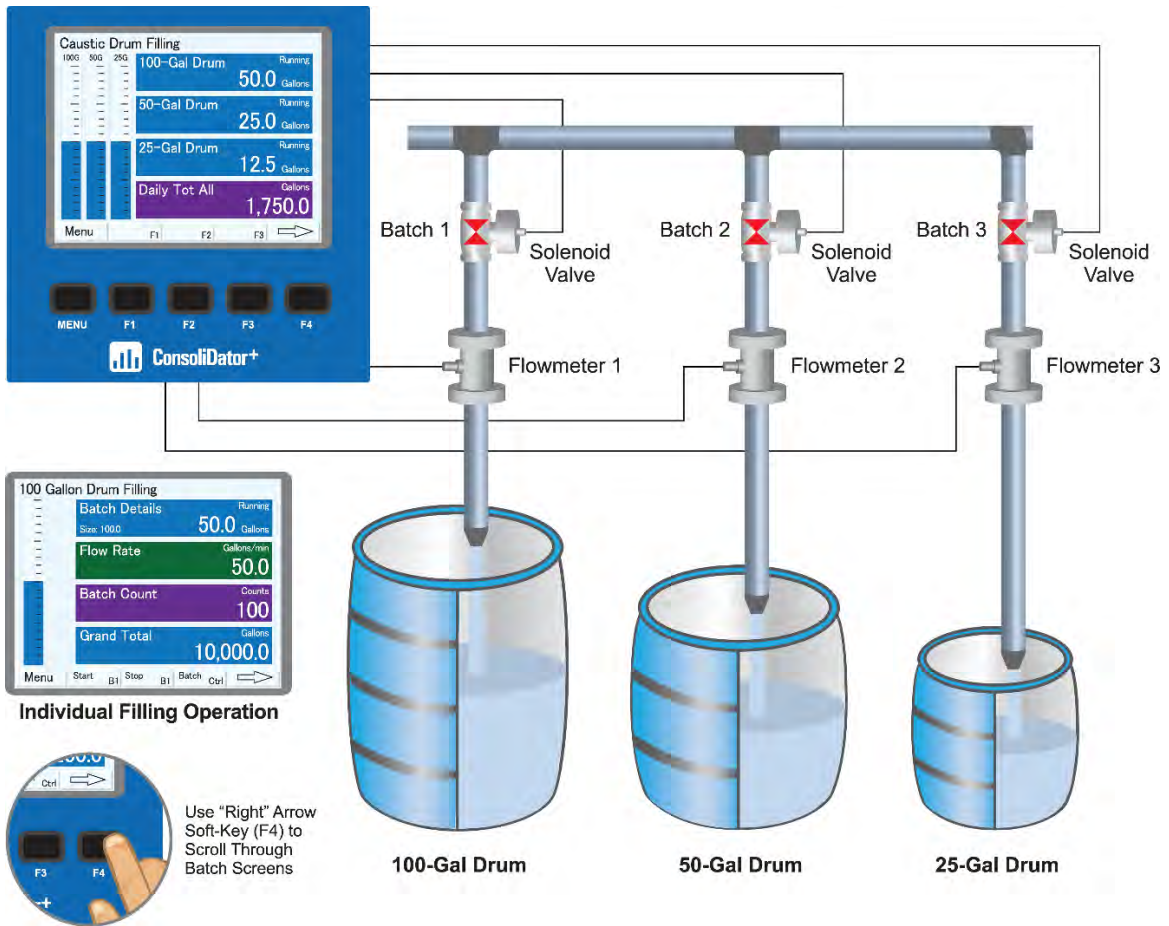

In this example, The ConsoliDator+ controls the simultaneous filling of multiple drums of different sizes using individual controls for each drum. The ConsoliDator+ can display information on multiple screens to help the operator follow along with the progress of the operation. The upper graphic depicts a screen of the overall drum filling operation, and the lower graphic depicts a screen of an individual drum filling operation. The operator scrolls through these screens with the F4 (right" arrow) button.

Example #4: Multiple Batches Run in Sequence

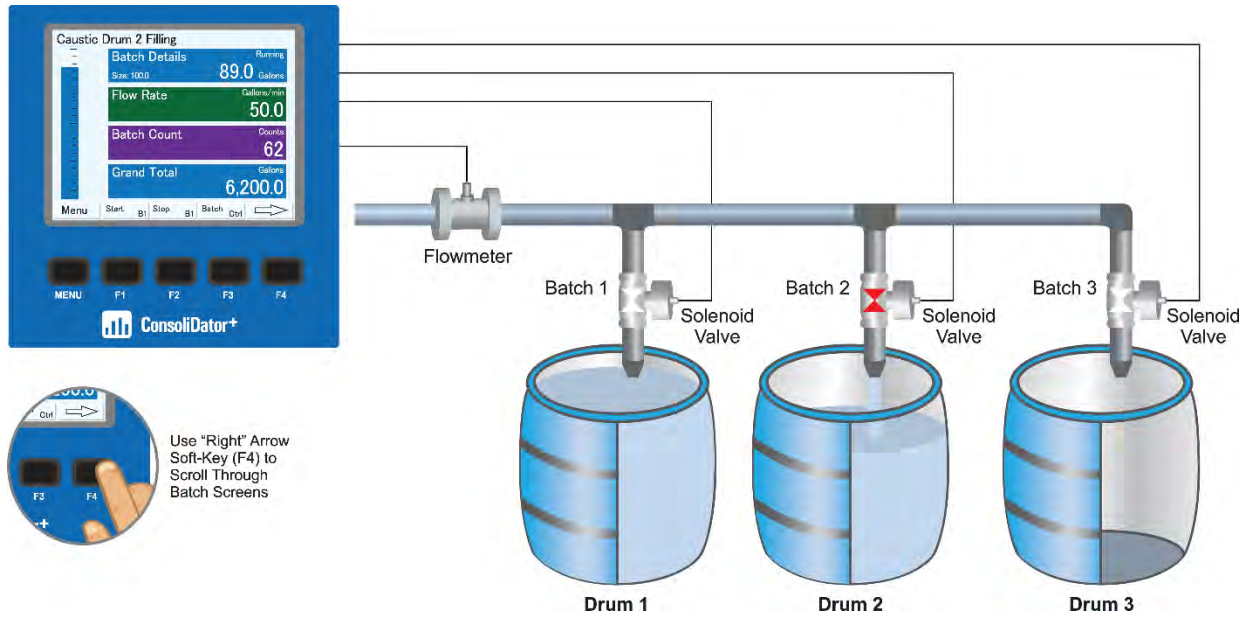

In this example, The ConsoliDator+ controls the filling of multiple drums sequentially using individual controls for each drum. The ConsoliDator+ is currently displaying the screen for the Caustic Drum 2 Filling operation. The operator can see the details for the other two filling operations and a view of the overall operation by pressing the F4 "right arrow" key.

Manual Batch Control

The manual batch control feature is used for batch processes that the operator wants to start manually. It can also be used when the batch size needs to be manually adjusted for each batch. The batch can be controlled by the button on the controller or a digital input.

Step 1: System Setup

Both valves are closed with an empty barrel in place. The batch screen is set up to display the batched total, rate, batch count, and grand total of completed batches.

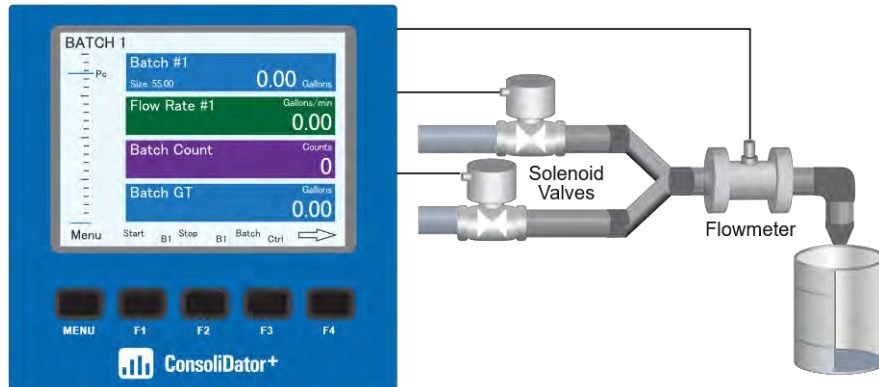

Step 2: Batch Start

The START button or (F1) is pressed. Both valves open. The barrel begins to fill.

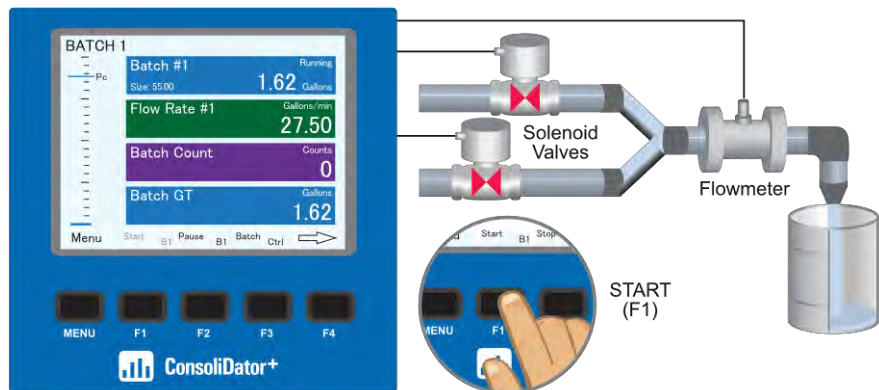

Step 3: Preclose Valve

When the batch total reaches a value of 50.00 (Preset [55.00] – Pre-close [5.00]) the full-flow valve closes. The fill rate of the barrel slows as a result.

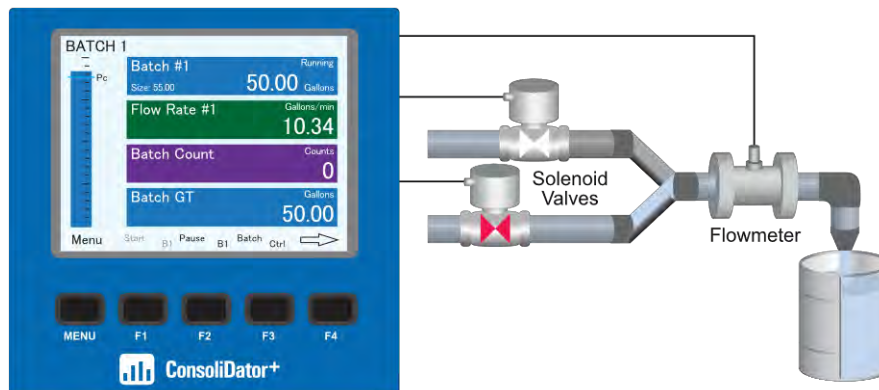

Step 4: Completed Batch
When the batch is complete, the restricted-flow valve closes.

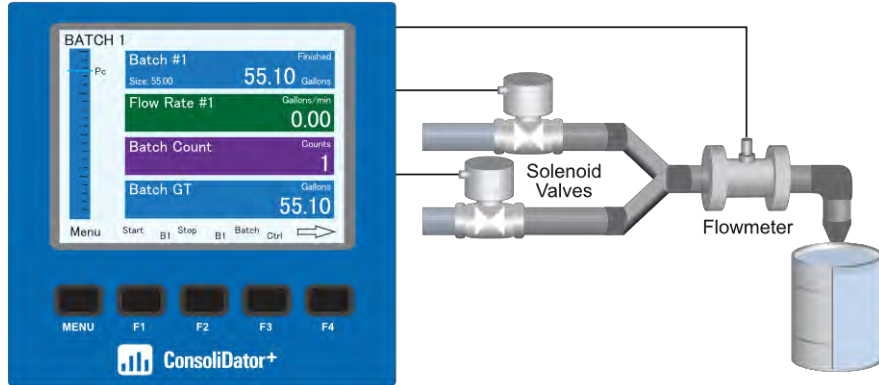

Step 5: Overrun Correction
If an overrun occurs, the controller automatically makes the adjustment to compensate for the overrun. The next batch will only start after the START button or (F1) is pressed.

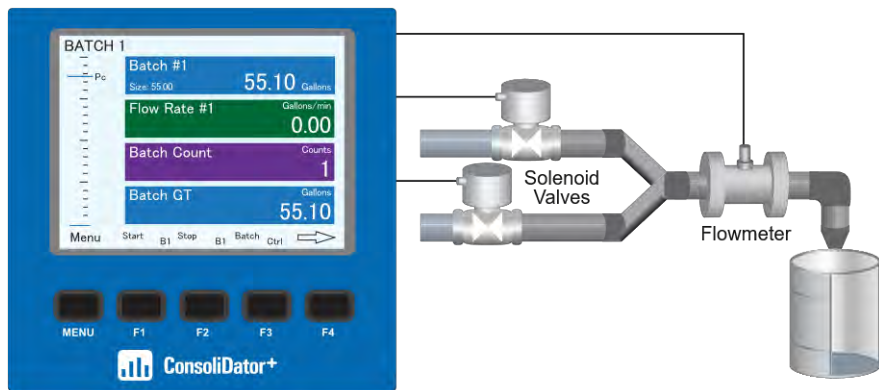

Step 6: Manual Start of Next Batch
A new, empty barrel is put in place and the START button or (F1) is pushed to manually start the next batch.

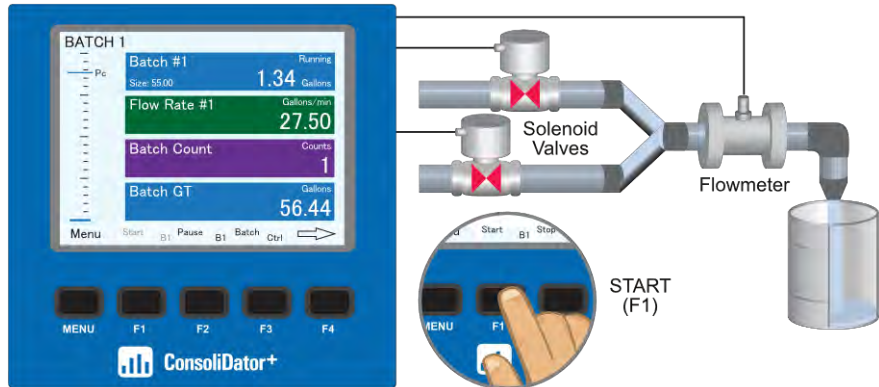

Step 7: Change Batch Size

While the process is stopped, a new preset fill amount may be selected with the Batch key (F3) for a different size barrel.

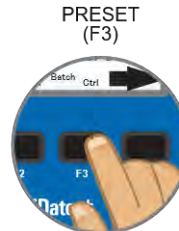

Step 8: Pause/Stop

At any time, press the Pause/Stop button or key (F2) once to pause the process, or twice to stop and cancel the batch, which stops the process.

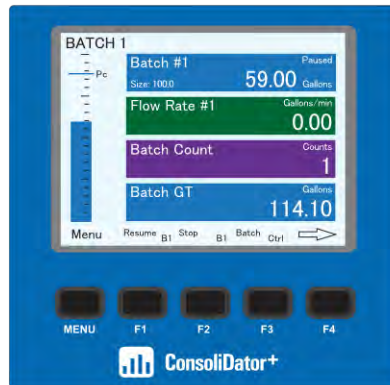

Step 9: Resume Batch

If the batch has been paused, then press the Resume button or (F1) to resume the batch process.



Automatic Batch Control

The automatic batch control feature is used for batches that start automatically once the previous batch is completed. There is no opportunity for the operator to change the batch size between batches. The batch can be controlled by the button on the controller or a digital input.

Step 1: System Setup

Both valves are closed with an empty barrel in place. The batch screen is set up to display the batched total, rate, batch count, and grand total of completed batches.

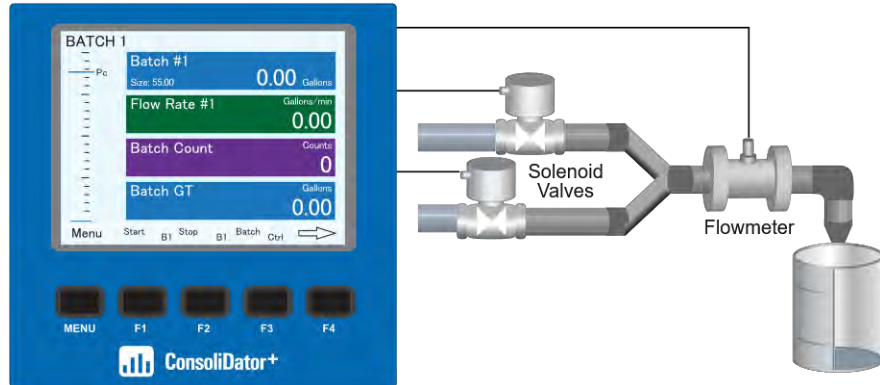

Step 2: Batch Start

The START button or (F1) is pressed. Both valves open. The barrel begins to fill.

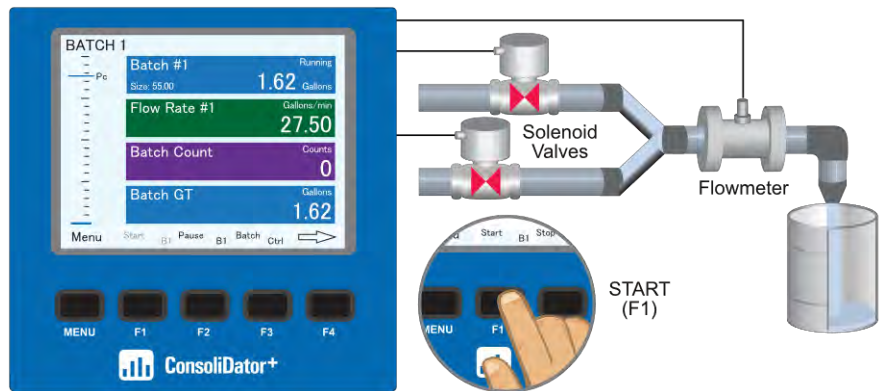

Step 3: Preclose Valve

When the batch total reaches a value of 50.00 (Preset [55.00] – Pre-close [5.00]) the full-flow valve closes. The fill rate of the tank slows as a result.

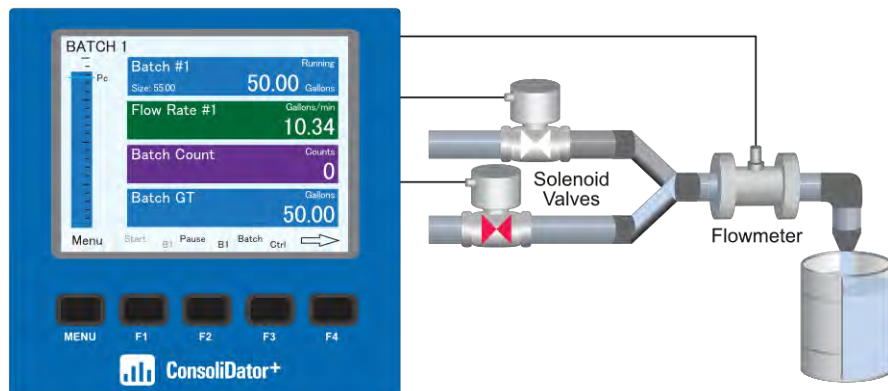

Step 4: Completed Batch
 When the batch is complete, the restricted-flow valve closes. If overrun occurs, then the preset must be adjusted to compensate for the overrun.

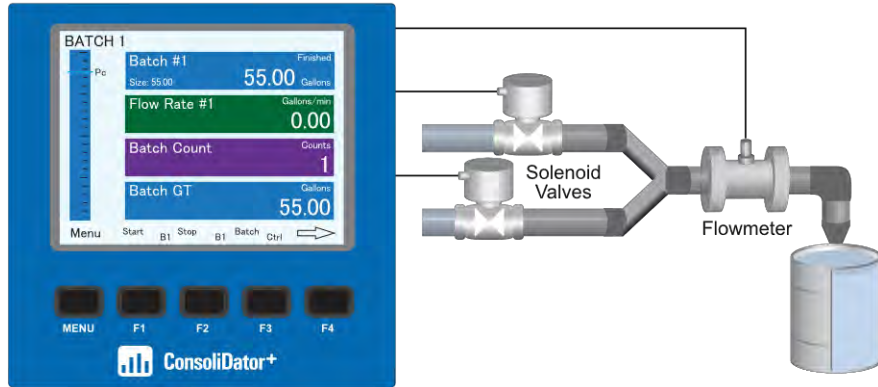

Step 5: Start Delay
 After the batch is completed, the operator removes the full barrel and places an empty barrel; the new batch starts automatically after 60 seconds (Time Delay).

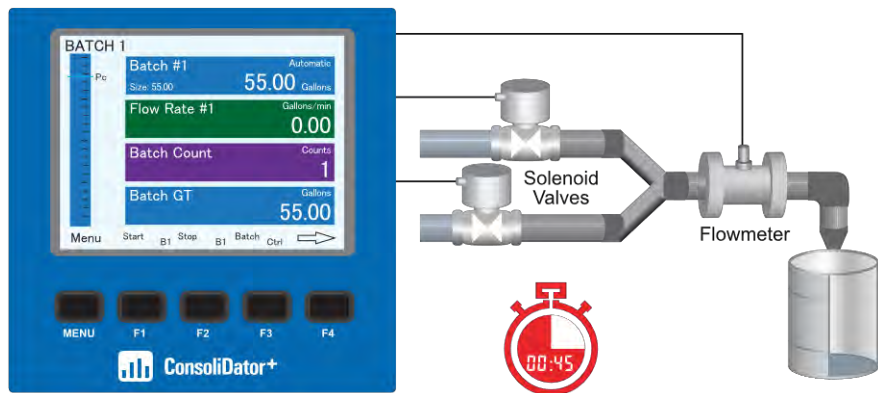

Step 6: Automatic Start of Next Batch
 The new batch begins automatically after 60 seconds, both relays activate and both valves open.

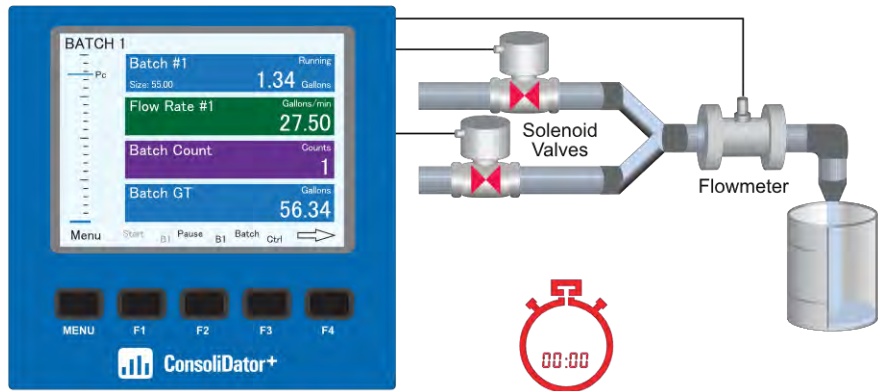

Step 7: Pause

At any time, press the STOP button or Stop key (F2) once to pause the process.

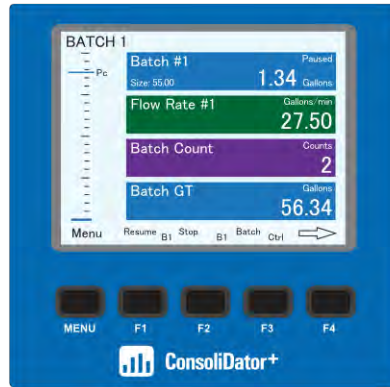

Step 8: Resume Batch

If the batch has been paused, then press START button or (F1) to resume the batch process.

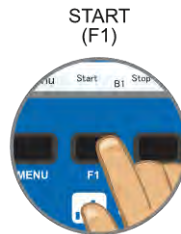

Step 9: Stop Process

At the end of the shift, press STOP button or Stop key (F2) twice to stop the batch process.

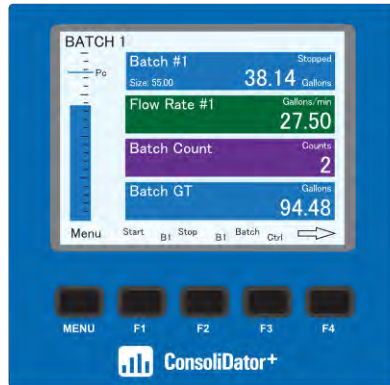

Printer Card Option

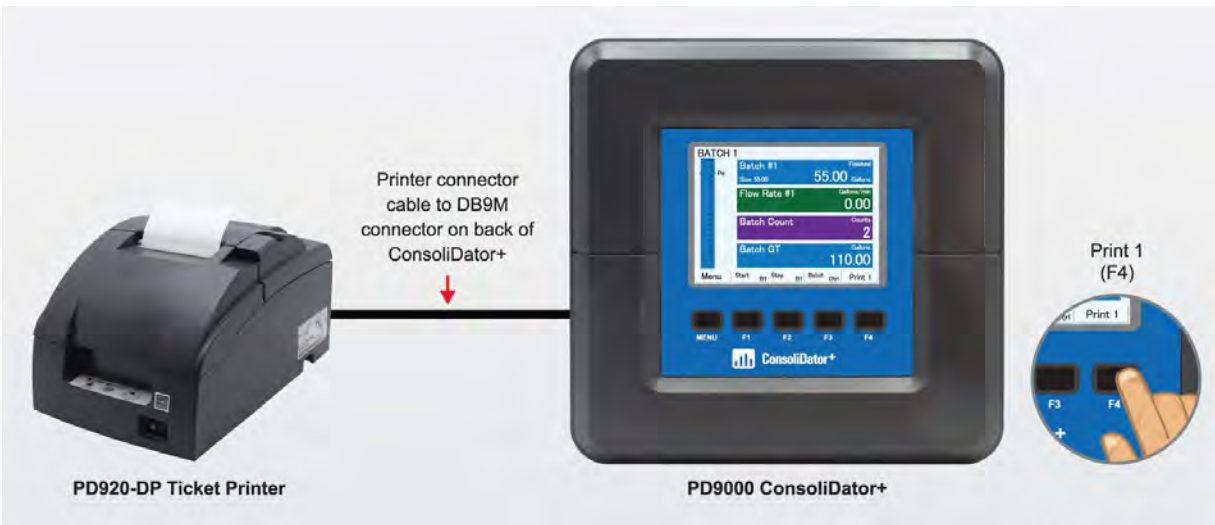

The ConsoliDator+ can be equipped with the [PDA9000-CP](#) printer card, which installs into any available slot. With a printer card installed, the number of additional I/O cards that can be added is reduced to six. Precision Digital offers the [PD920-DP](#) desktop ticket printer and the [PDA920-DP-WMK](#) wall mounting kit. The printer connects directly to the PD9000 using the included DB9M cable and is easily configured with the ConsoliDator+'s free programming software.

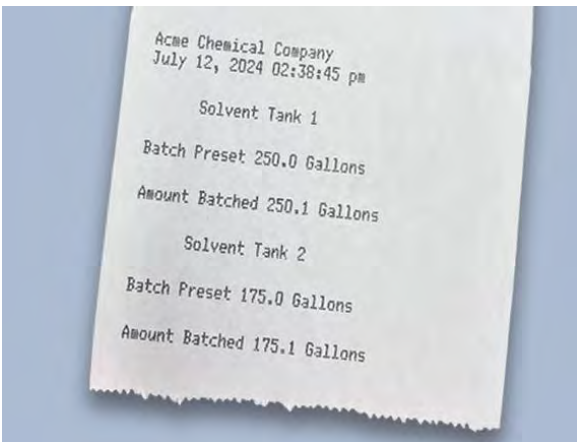

Sample of Printed Ticket for Batch Process

Ticket Printing Features:

- Custom ticket printing for batch process information & other uses
- Automatic and manual printing
- Free ConsoliDator+ software allows for easy setup of batch controller and ticket printer
- Select batch information for printing with up to 24 text entries
- Select action for when to print ticket
- Wall mounting kit available

PDA9000-CP Printer Card Connections

The printer card output uses an RS-232 serial connection.

Cable Connection: DB9M - 10 ft DB9F to DB25M Null Modem Cable (Included with printer card)

Screw Terminal Connection: 5.0 mm pitch (Rx, Tx, /CTS, GND)

Notes:

1. Use only one of the above connection options.
2. ConsoliDator+ models equipped with a printer card are not UL Listed.
3. Printer card occupies one I/O slot.

Recommended Printer

[PD920-DP:](#)

Desktop printer which contains a desktop impact printer, plug-in power supply, and 10 ft DB9F to DB25M Null Modem cable.

[PDA920-DP-WMK:](#)

Desktop printer's wall mount accessory.

Setup for Ticket Printing

The printer card option can be purchased and installed at the factory, or it can be purchased separately and installed in the field. The system automatically detects the printer card and adds the menus needed for configuration using the ConsoliDator+ software and for operation of the printer from the front panel buttons.

There are three steps to the configuration for ticket printing:

1. Setup > System menu > Printer
2. Setup > Print Ticket menu
3. Setup > Screens > F1 – F4 > Print

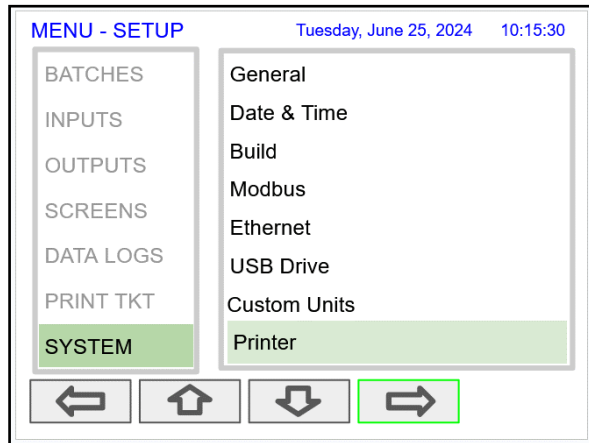

The ConsoliDator+ software must be used for setting up the printer.

There is a Test Print button available to confirm the printers operation.

This function prints the system information, including the I/O cards installed and the firmware versions.

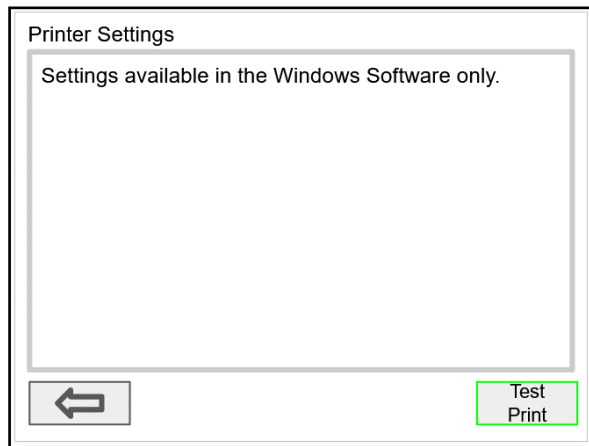

Setup Print Ticket

The *Setup Print Ticket* screen is used to select and print a ticket.

The information to be printed must be set up using the ConsoliDator+ software.

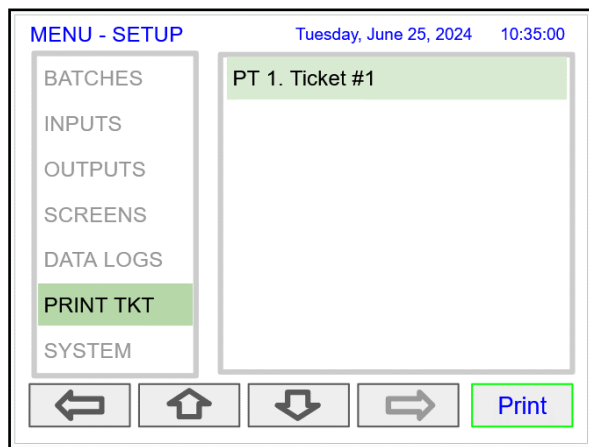

Printer Settings Using ConsoliDator+ Software

Use the *System – Printer* menu to enter the text to be used for ticket printing.

There are up to 24 text entries that can be configured.

- Establish the tab settings to be used for printing various items on the same line.
- Click on a blank text row to enter a new text line.

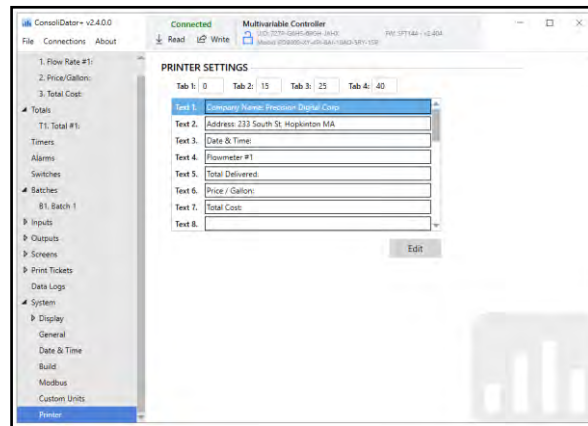

Setup Print Tickets Menu

The *Print Tickets* menu is used to select the information to be printed and the order in which it is printed.

- Make sure that tabs are set up correctly according to the space needed for printing the selected values and text.
- Use blank lines as needed to make the printout easy to read.
- Lines can be easily inserted, removed, or edited.
- Select an appropriate action after the ticket is printed or no-action. For example, in this screen it is shown that after Ticket #1 is printed, Batch #2 will start.
- Batches can be set up to automatically print a ticket when the batch is completed.

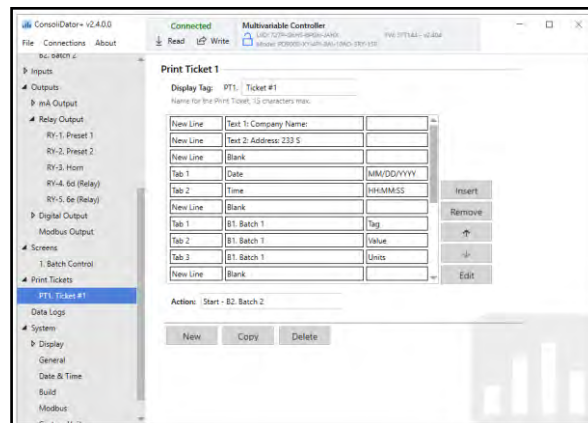

Batch Ticket Printing: Automatic

The batch can be set up to automatically print a ticket when the batch is completed.

Select Finish Action: Print Ticket.

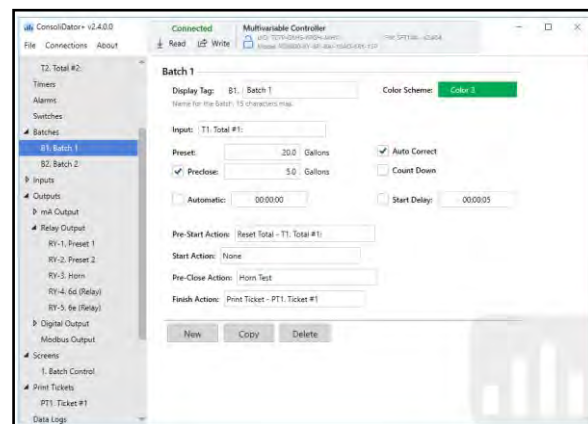

Batch Ticket Printing: Manual

The batch can be set up to manually print a ticket at any time. Use the Screens menu to set up a function key to print tickets. In this screen it is shown that F4 function key is set up to Print Ticket 1.

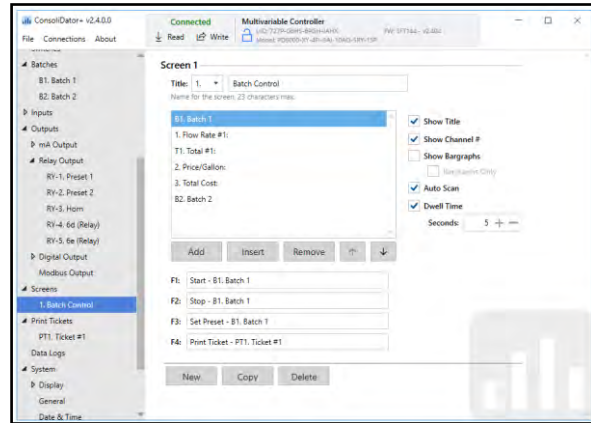

Printer Setting Defaults

The System > Printer configuration includes a list of default settings. These defaults are automatically applied to every new Print Ticket setting. Users have the flexibility to modify or remove these defaults based on their specific requirements.

- {End of Ticket}\n\n\n\n\n\n\n\n\n\n
- Tabs set to 3, 6, 9, and 12
- {Start of Ticket}
- {End of Ticket}
- {Start of Print}
- {End of Print}
- Print Ticket lines
 - First Line: "Start of Ticket" (if found), otherwise a blank line.
 - Second Line, "End of Ticket", only if found in Printer configuration. Otherwise, the 2nd line will be another blank line.

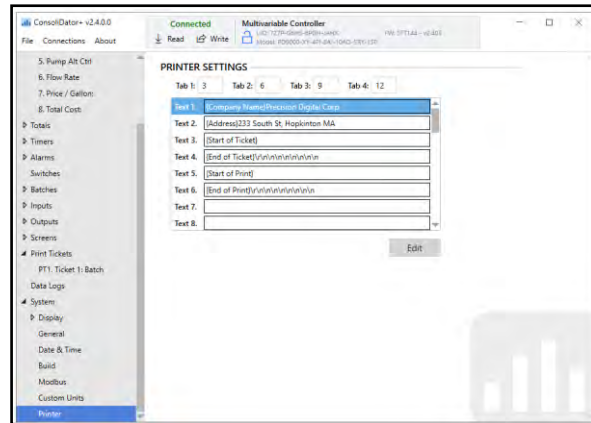

Description of Commands

- \n: Add new line
- \n\n: Add two new lines
- \t: Move cursor to the first tab
- \t\t: Move cursor to the second tab
- \r: Reset cursor to position zero

Action at End of Ticket Printing

There are many actions that can be selected and executed after the ticket is printed. This screen shows that after printing ticket 1, the system will automatically start Batch 2.

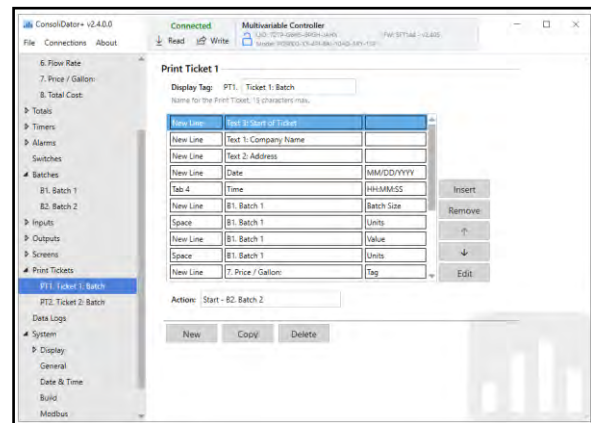

Pump Controller Setup

The ConsoliDator+ can be set up as a pump controller using the *Channels > Control* menu. The easiest way to configure the pump controller functions is by using the ConsoliDator+ software, but all the functions can be set up from the front panel also.

The following pump control functions are available:

- On-Off Control
- On-Off Multi-Set Control
- Lead-Lag Control
- Pump Alternation Control

All these functions are available through the *Channels* menu.

The *On-Off Control* function takes the input from a level channel and provides a digital output (on/off) that is used as the control signal to a relay or as the input to other channels used for Lead-Lag or Pump Alternation control. Any input with logic units (on/off, 1/0) can be used for any of the pump control functions.

Channels can be used to monitor the state of the relays driving the pumps.

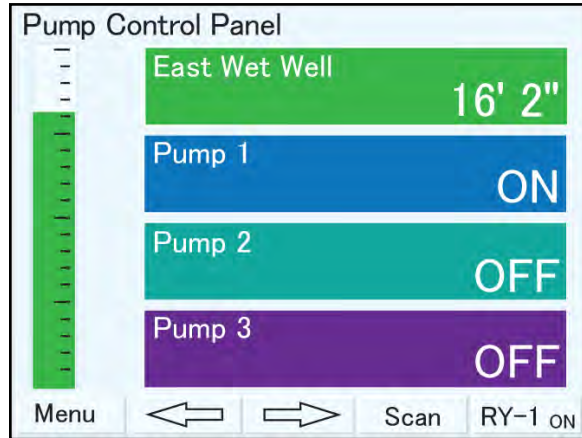

This screen shows the wet well level and the state of the three pumps used in alternation mode.

The F4 key is used to force on relay 1 while it is being pressed.

Channel Setup for Pump Control

Alternation Input Sources

Most level control applications use level channels as the input to On-Off Control channels. The level channel is set up to read the signal from a level transmitter and display the level either in height or volume units. The continuous level monitoring allows for selecting multiple alternation points.

A level switch can be connected to a digital input and the digital inputs will alternate the pumps in the same way as the On-Off Control channels.

Step 1.

Set up a channel to measure the level of the wet well, it can be in units of volume or units of height (distance).

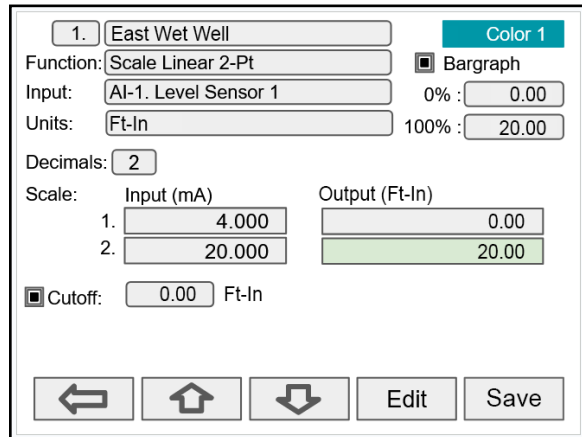

Step 2.

Set up channels for On-Off control based on the level of the wet well and the number of pumps to be used to control the level of the wet well.

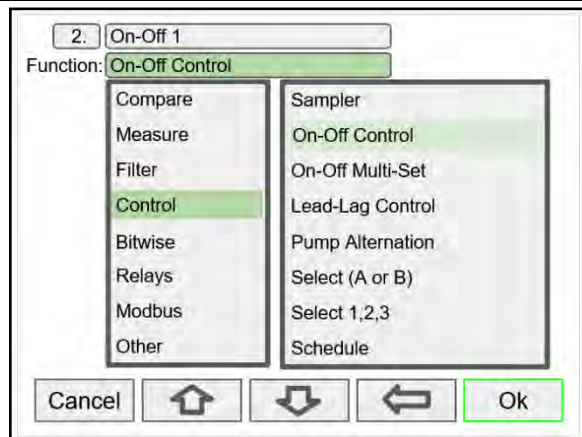

On-Off Control Settings

- Enter the On/Off control points
- Select the On/Off actions, if needed
- Make sure the units are logic units (ON/OFF)

Set up channels for On-Off 2 and 3 in the same way as shown here.
 On-Off 2: 17.00/5.00 Feet
 On-Off 3: 18.00/6.00 Feet

- There are many On/Off actions that can be selected.

Examples:

- Post Modbus signal
- Start/Stop timer
- Turn on the horn
- Etc.

The screenshot shows the configuration for 'On-Off 1'. The 'Function' is set to 'On-Off Control' and the 'Input' is '1. East Wet Well'. The 'Break' is set to 'OFF' with a checked 'Randomizer' option. The 'On' time is 16.00 Ft-In and the 'Off' time is 4.00 Ft-In. Both 'On Delay' and 'Off Delay' are set to 0 seconds. The 'On Action' and 'Off Action' are both set to 'Do Nothing'. The 'Units' are set to 'ON/OFF'. Navigation buttons include 'Cancel', 'Home', 'Back', 'Edit', and 'Save'.

Pump Alternation Channel

Step 3.

The Pump Alternation channel takes the logic signal generated by the On-Off Control channels and provides the alternation sequence to be used by the relays driving the pumps.

Level switches can be used as digital inputs that can serve as backup to the continuous level monitoring On-Off controls.

Digital Inputs

Digital inputs and level switches can be used to create a simple pump alternation control system.

Modbus Inputs

Modbus inputs can be used to create a pump alternation system.

- Select the inputs to the alternation channel
- The Position Count should be the same as the number of inputs
- Alternate on Time: If desired, enter the alternation time to switch to the next pump when the level is maintained above the On setting.
- On/Off delays are available, but not required.
- Units must be logic units (On/Off)

The screenshot shows the 'Pump Alt Ctrl' configuration. The 'Function' is 'Pump Alternation'. The 'Inputs' list includes '2. On-Off 1', '3. On-Off 2', and '4. On-Off 3'. The 'Position Count' is set to 3. The 'Alternate on Time' is 00:00:00. 'On Delay' and 'Off Delay' are both 0 seconds. The 'Units' are 'ON/OFF'. The 'Ok' button is highlighted in green.

Pump Alternation channel using On-Off Control channels

The screenshot shows the 'Pump Alt Ctrl' configuration with digital inputs. The 'Function' is 'Pump Alternation'. The 'Inputs' list includes '2. DI-1. Digital In 1', '3. DI-2. Digital In 2', and '4. DI-3. Digital In 3'. The 'Position Count' is 3. 'Alternate on Time' is 00:00:00. 'On Delay' and 'Off Delay' are 0 seconds. The 'Units' are 'ON/OFF'. The 'Ok' button is highlighted in green.

Pump Alternation channel using digital inputs

The screenshot shows the 'Pump Alt Ctrl' configuration with Modbus inputs. The 'Function' is 'Pump Alternation'. The 'Inputs' list includes '2. MB-1. Modbus Input 1', '3. MB-2. Modbus Input 2', and '4. MB-3. Modbus Input 3'. The 'Position Count' is 3. 'Alternate on Time' is 00:00:00. 'On Delay' and 'Off Delay' are 0 seconds. The 'Units' are 'ON/OFF'. The 'Ok' button is highlighted in green.

Pump Alternation channel using Modbus inputs

Pump Alternation Relays

Step 4.

The Outputs > Relays menu is used to set up the Pump Alternation channel as the input for the relays according to the alternation position selected.

- Use a descriptive tag for the relay (e.g. Pump 1), this can be used to create a Pump Control Annunciator panel using the Screens menu.
- Select an alternation channel as the input.
- Assign the alternating position for each relay.

6a: Relay Output Runtime: OFF
 RY-1: Pump 1 01:58:13
 Input: 5. Pump Alt Ctrl

Position: 1 Power UpDelay: 0 sec

On Delay: 0.0 sec
 Off Delay: 0.0 sec

Pulse Output

Break: Realy Off On Time: 1.0 sec
Off Time: 1.0 sec

Fail-Safe

Cancel [Home] [Down Arrow] Edit **Ok**

6b: Relay Output
 RY-2: Pump 2
 Input: 5. Pump Alt Ctrl

Position: 2 Power UpDelay: 0 sec

On Delay: 0.0 sec
 Off Delay: 0.0 sec

Pulse Output

Break: Realy Off On Time: 1.0 sec
Off Time: 1.0 sec

Fail-Safe

Cancel [Home] [Down Arrow] Edit **Ok**

6c: Relay Output
 RY-3: Pump 3
 Input: 5. Pump Alt Ctrl

Position: 3 Power UpDelay: 0 sec

On Delay: 0.0 sec
 Off Delay: 0.0 sec

Pulse Output

Break: Realy Off On Time: 1.0 sec
Off Time: 1.0 sec

Fail-Safe

Cancel [Home] [Down Arrow] Edit **Ok**

Pump Control Annunciator Panel

Step 5.

The *Screens* menu can be used to create an annunciator panel to help the operator view the status of pumps. The use of appropriate colors enhances the user's experience.

- Create channels using the relays (pumps) as input.
- In the *Screens* menu select the order in which the pumps status is displayed.
- Set up the function keys as needed. They can be set up to acknowledge alarms, turn on pumps manually while being pressed, go to the next screen, etc.

Details Screen Showing Pump Status and Level

On & Off Time Delays

To prevent turning pumps off and on at the same time, it's recommended to use On delays. The On & Off delays can be set up in different places, but it is recommended to use the relay's setup for the delay settings.

Alternation Groups

An alternation group is created by setting up a channel that uses the Pump Alternation function and the inputs from On-Off Control channels, digital inputs, Modbus inputs, etc.

Relays are set up using the Pump Alternation channel as the input and selecting the alternating position.

Multiple alternation groups can be set up using different sources for each group.

Alternate on Time

This is the maximum time any relay in the group will be continuously on. After the alternation time has elapsed, the relay will turn off and another relay will turn on. This feature is useful for applications where the level is maintained with one pump for a long time. Depending on the setup and conditions, it will help distribute the load among the pumps in the group.

Alternation Sequence

The first relay on is the first relay off, when more than one relay are activated. The lowest reset point (Off) is used for the alternation cycle.

Break

If *Relay On* is selected, only one of the alternation relays will be on when a break is detected.*

*Note: Break needs to be set in the analog input menu.

Multi-Set Channel

Instead of using multiple channels for On-Off control, one channel can be set up with multiple set points.

The Multi-Set channel can be used as the input to an alternation channel, similar to the setup shown in the previous screen.

- Enter the Set (On) and Reset (Off) points.
- On/Off delays are available, but not required.
- Units must be logic units (On/Off)
- Use the On-Off Multi-Set channel as the input to the Pump Alternation channel.

	Set (On):	Reset (Off):
1.	16.00	4.00
2.	17.00	5.00
3.	18.00	6.00

Lead-Lag Control Channel

The Lead-Lag control channel uses the On-Off channels as the input.

The main pump (Lead) always turns on first, the secondary pumps (Lag) turn only if the main pump is not able to maintain the level below the additional On/Off control points.

- Select the On-Off control channels.
- Units must be logic units (On/Off)

Application Example: ConsoliDator+ Monitoring Wet Well Level & Controlling Three Pumps

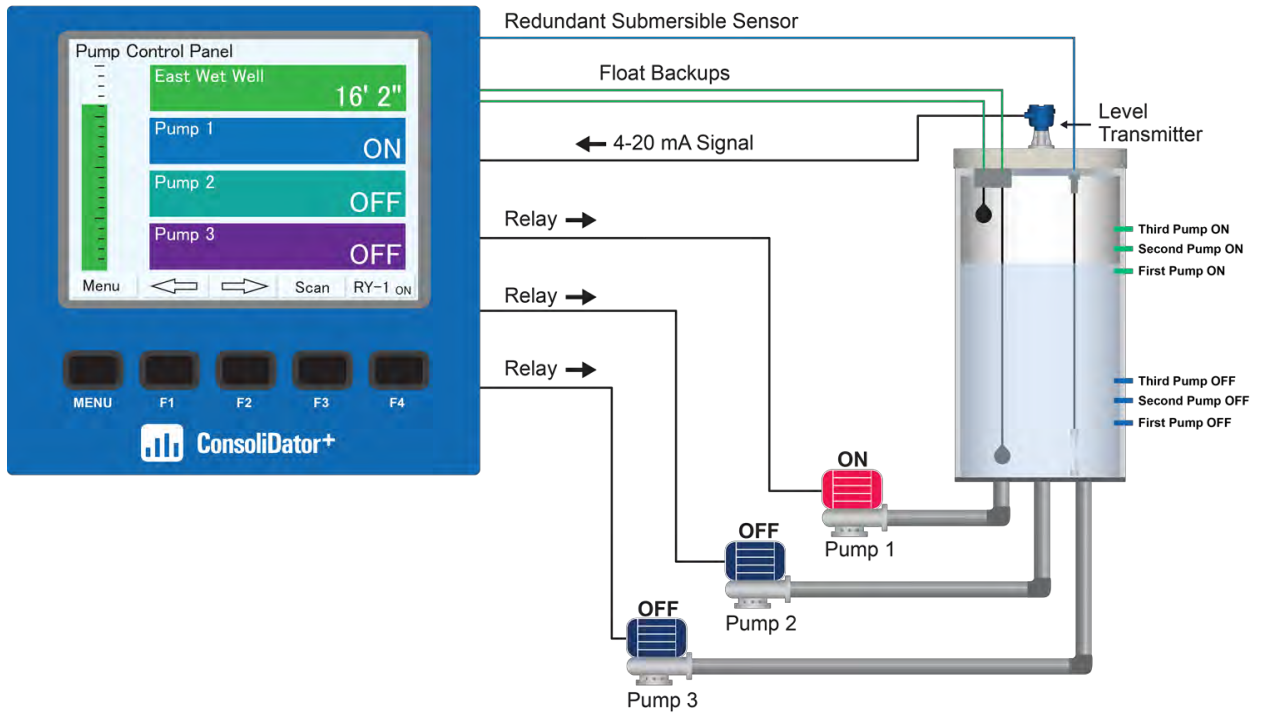

In this example, the ConsoliDator+ utilizes Lead-Lag with Pump Alternation and On-Off Multi-Set features to control the level in the wet well with three pumps via relay outputs. A level transmitter located atop the well sends a 4-20 mA signal to the ConsoliDator+, which displays pump statuses and level in feet & inches. The ConsoliDator+ will automatically switch to a redundant sensor if the primary fails. Float backup status can also be indicated on screen.

Features used in this application:

- Multiple On/Off set points with optional randomization.
- Remote addressable set points.
- Lead-Lag with or without alternation.
- Alternation based on time.
- Delayed and staggered pump start up after power loss.

Setup Inputs

The *Setup Inputs* screen is used to configure the hardware inputs, assigning a user-defined tag, and setting the filter values.

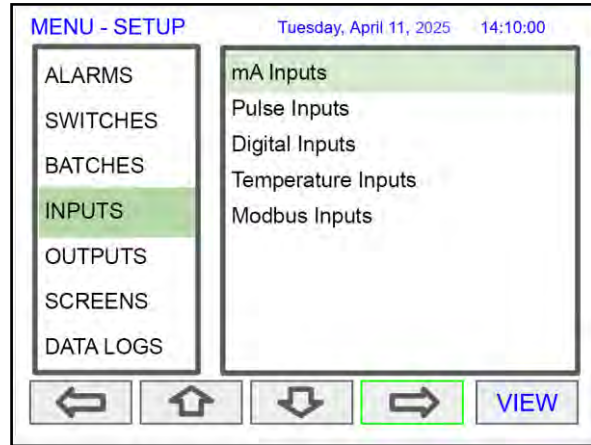

Setup 4-20 mA Inputs

This screen gives you a quick view of the mA inputs connected, the slot # and position, and the actual mA input value.

Press the **Right Arrow** key to set up the selected input.

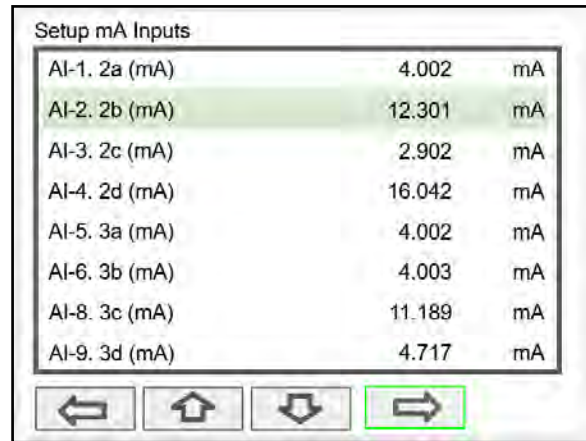

The top line, for each input, shows the slot # and input location (2b = slot #2, second input from the left). It also shows the actual current input.

The next line shows the input type and # (AI-2) with the default tag, which can be changed at any time.

- Filter*: Select window average time or IIR time.
- Filter Bypass: If the signal change is greater than the bypass value, the reading jumps to the actual value. The bypass value is in % of full scale.
- Glitch Filter: Eliminates short duration noise spikes.
- Break Below: Set the mA value at which a break is reported to the system.
- Disable Input Channel: This turns off the power to the input, but the settings are saved for future use. This should only be used to save power on unused inputs.

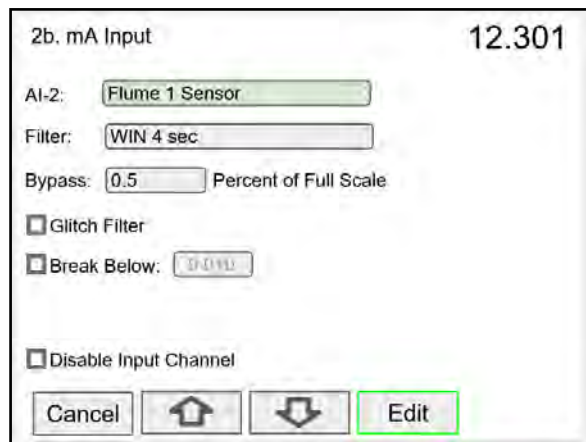

***Need more filtering?**
 If you need a more stable reading, select IIR 16 sec or IIR 32 sec setting.
 IIR: Infinite Impulse Response

IMPORTANT

- The *Filter* selection depends on the stability of the input and the desired stability of the display. The larger the selected filter setting, the slower the display response is.

Filter Settings

Most of the applications should work fine with the default filter setting.

There are two types of filters available:

- Window Average: This filter is based on time; samples are averaged within the selected time window; older samples are discarded to make room for new samples.
- IIR (Infinite Impulse Response): This filter is a first order type, and it is equivalent to an analog RC filter. The time constant of the filter is roughly what defines the “delay” for the filter to reach its steady state. An IIR filter has a feedback loop from the output which distinguishes it from an FIR (Finite Impulse Response) filter, which uses only the input signal.

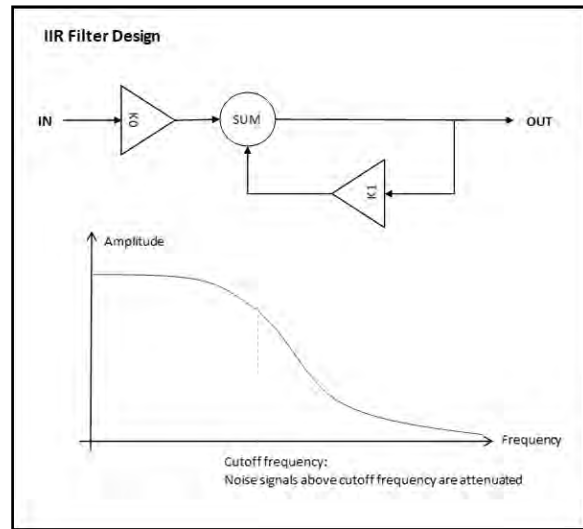
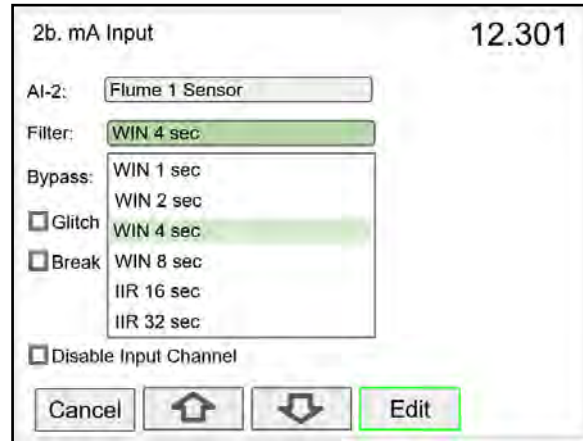

How to Decide what Filter to Use

The selection of the filter setting has many factors that need consideration; the user should weigh the pros and cons of increasing or decreasing the filter setting.

Do you need a steadier reading?	Increase the filter setting
Do you need a faster response?	Reduce the filter setting
Do you need the fastest response possible?	Set the filter to None

In most cases, you need to find the balance between a steady reading and the response time.

IMPORTANT

- The *Filter Bypass* setting is an excellent feature used to achieve a fast response for larger changes in the input signal and a steadier reading for small changes, below the bypass value.

Setup Pulse Inputs

The top line, for each input, shows the slot # and input location (1a = slot #1, first input from the left). It also shows the actual frequency, state of the input, and the number of pulses received since power up, to a maximum of 8,388,607. The counter rolls over to 0.

The next line shows the input type and # (PI-1) with the default tag, which can be changed at any time.

- Type: Select the pulse input type.
- Low Gate: this is the time window used to calculate and update the rate.
- High Gate: This is the time window used to calculate slow rates before the rate goes to zero.
- Low Speed: This setting is used as a de-bounce filter for contact closure or switch inputs.

Threshold:

Is the voltage level at which a transition from high to low is detected. For example, the "Active 1.2V Thrshld" setting will detect a square wave signal when it falls below 1.2 V.

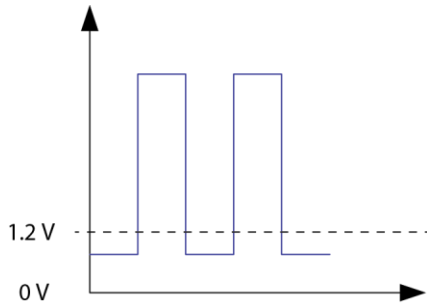

1a: Pulse Input 9999.99 Hz

PI-1: 1a (Pulse) Counter: 08388607

Type: Active 1.2V Thrshld

Low Gate: 1

High Gate: 2

Low Speed, 100 Hz max

← ↑ ↓ Edit

1a: Pulse Input

PI-1: 1a (Pulse)

Type: Active 1.2V Thrshld

Low Gate: 1

High Gate: 2

Low Speed, 100 Hz

Active 1.2V Thrshld

NPN 1.2V Thrshld

PNP 1.2V Thrshld

Reed Switch

Coil 20 mV Thrshld

Active 2.5V Thrshld

NPN 2.5V Thrshld

PNP 2.5V Thrshld

Coil 100 mV Thrshld

← ↑ ↓ Ok

Setup Temperature Inputs

This screen gives you a quick view of the Temperature inputs connected, the slot # and position, and the real time temperature readings. The available temperature input types are thermocouple and RTD.

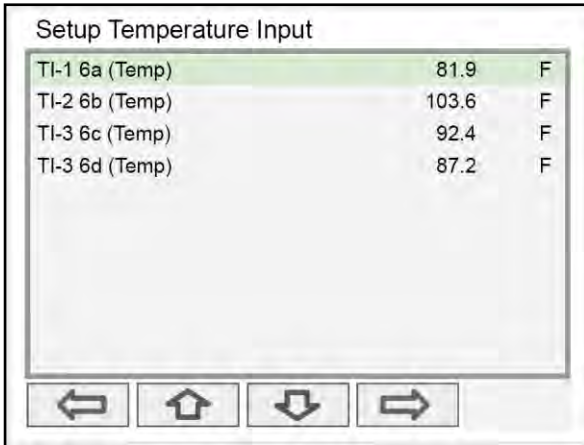

Press the Right Arrow key to set up the selected input.

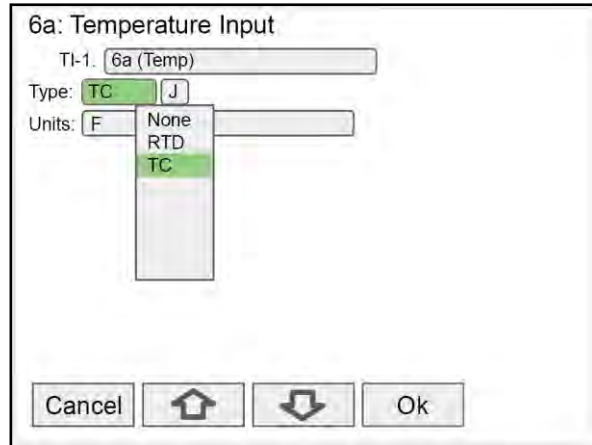

Select the Input Type from the dropdown menu and select Ok. In this case, Thermocouple (TC) Input Type is selected.

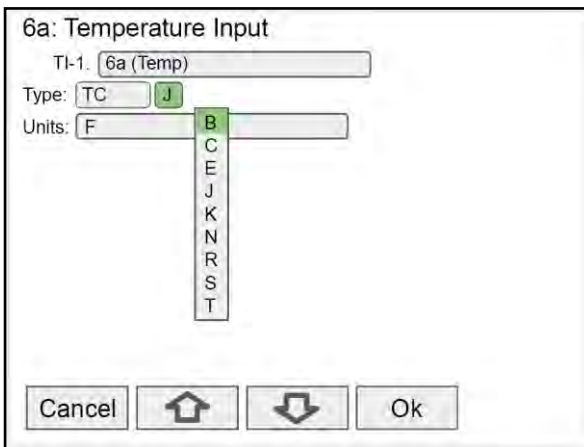

Select Thermocouple Type from the dropdown menu and select Ok.

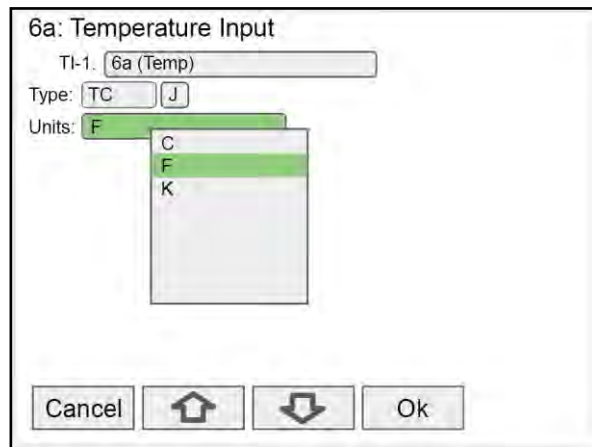

Select temperature units from the dropdown menu and select Ok.

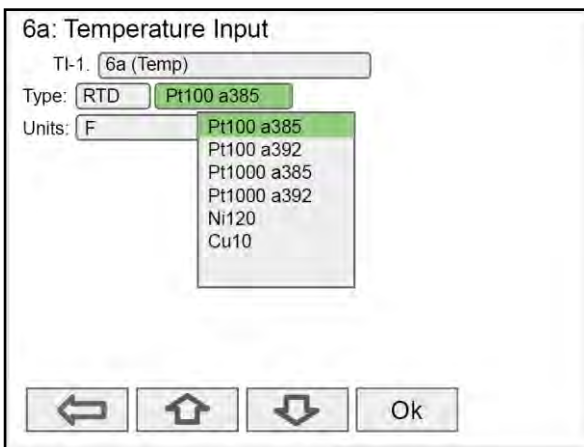

The RTD inputs are configured in a similar manner.

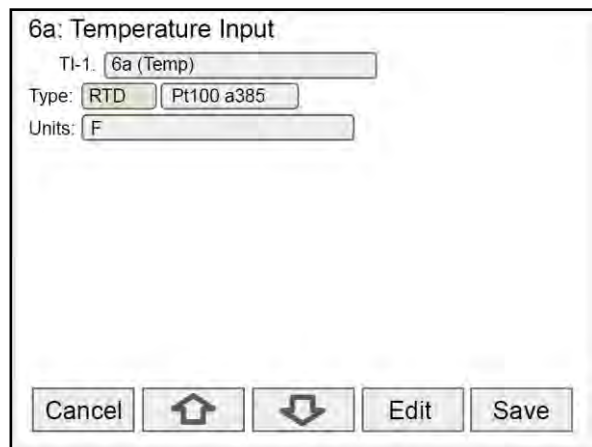

Select Save when the desired settings are configured.

Setup Digital Inputs

The digital inputs can be assigned to perform various user functions, such as trigger alarm, acknowledge alarms, reset total, etc.

DI-1. Digital Input 1	Start / Stop	OFF
DI-2. Digital Input 2	Reset Total	ON
DI-3. Digital Input 3	Ack Alarm	OFF
DI-4. Digital Input 4	Go to Screen	OFF
DI-5. Digital Input 5		ON
DI-6. 3a (Digital)		OFF
DI-7. 3b (Digital)		OFF
DI-8. 3c (Digital)		OFF
DI-9. 3d (Digital)		OFF
DI-10. 3e (Digital)		OFF

Digital Input Functions

Digital Input OFF

DI-1:

Active Low

Function:

A digital input can be used to execute one of the listed functions and at the same time, it can be used to trigger an alarm or to totalize (count) how many times the function has been executed (e.g. Reset Total).

Digital Input

DI-1: Alarm

Active

Function: <ul style="list-style-type: none"> Button Channel Total Timer <li style="background-color: #e0ffe0;">Alarm Screens Data Log Simulate 	<ul style="list-style-type: none"> <li style="background-color: #e0ffe0;">Ack Alarm Reset Alarm Set Points
--	---

The available functions depend on the I/O cards installed, the Add-On features enabled, and the controller's configuration.

List of Digital Input Functions

- None: Use digital input (DI) to trigger an alarm or timer
- Button: Digital input behaves as a front panel button
- Channel: Tare, Reset Tare, Reset Max, Reset Min
- Total: Access total functions (Reset, Add To, ...)
- Timer: Access timer functions (Start, Stop, ...)
- Alarm: Access functions (Ack, Reset, Set Points)
- Screens: Next, Previous, Stop/Scan, Go To, View, ...
- Data Log: Log Entry, Start / Stop, Remove USB, New File
- Simulate: Pulse input, mA input, Modbus input, Channel, Total, Timer, Alarm
- Horn: Silence, Snooze, Test
- mA Output: Manual, Hold (Manual), Automatic, Manual / Auto, Hold / Auto
- Relay: Reset info, Force On, Force Off, Manual On, Manual Off, Hold (Manual), Automatic

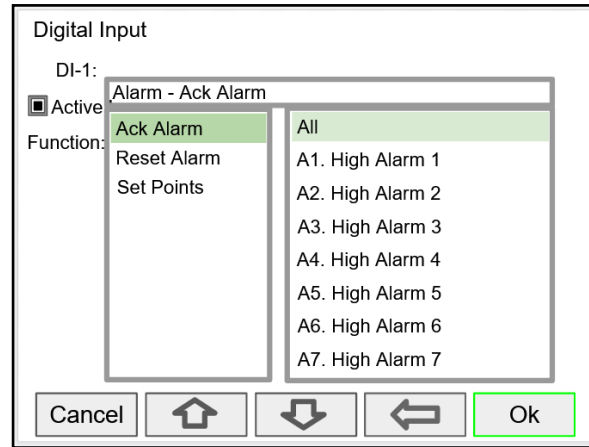

Note: The elements to be acted upon must be created before trying to set up the digital input; otherwise it is not available in the list of functions to execute. For example, to assign the digital input to tare a channel, a Tare Channel must be created first.

Alarm Reset: The alarm condition is cleared, allowing the alarm to trigger again based on input.

Acknowledge: The input must cross the reset point to trigger new alarm after it has been acknowledged.

Digital Inputs & Data Logger

If the Data Logger feature is enabled, a digital input can be used to start/stop, capture a log entry at any time, safely remove USB, start a new log file.

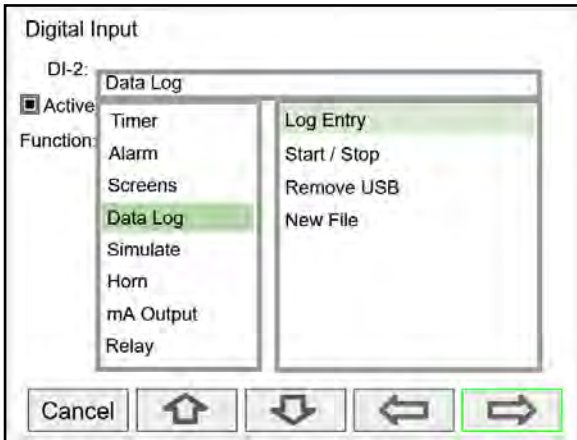

IMPORTANT

- The Data Logger functions are available only if the Add-On feature has been enabled in the System – General Settings, see *How to Enable Add-On Features* on page 139. Refer to page 133 for *Setup Data Logs*.

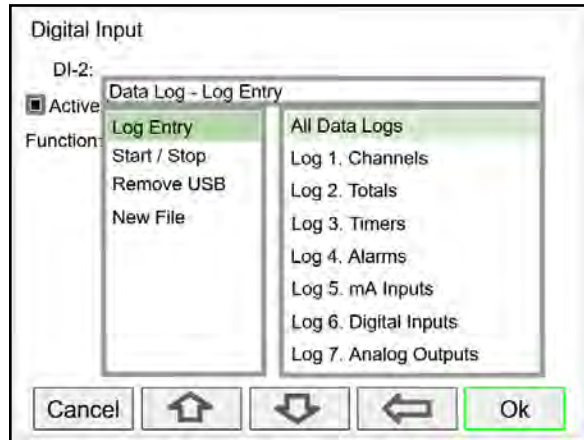

Choose to capture all the data logs or choose any log.

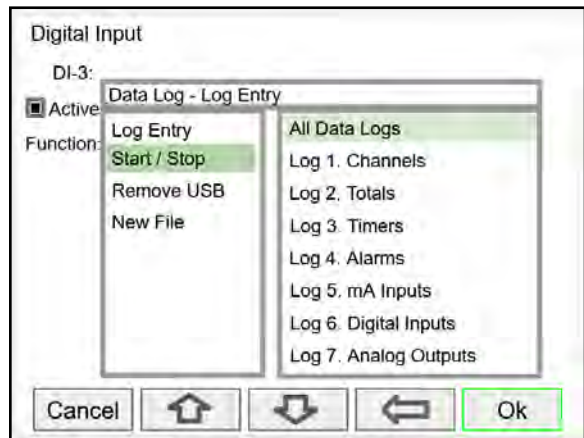

Choose to start / stop all data logs or choose any log.

Safely Remove USB

Digital inputs can be used to safely remove the USB drive in case the function keys are not available.

Start a New Log File

Digital inputs can be used to start a new log file.

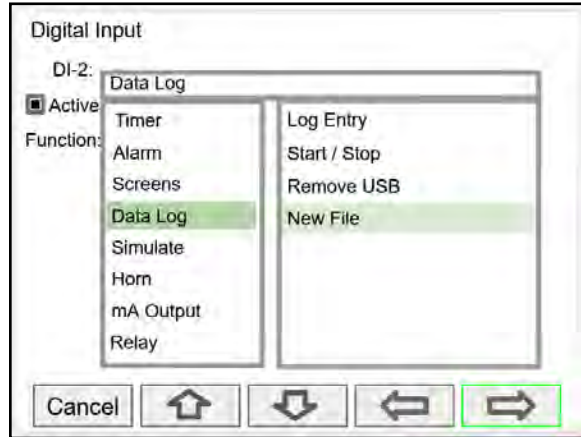
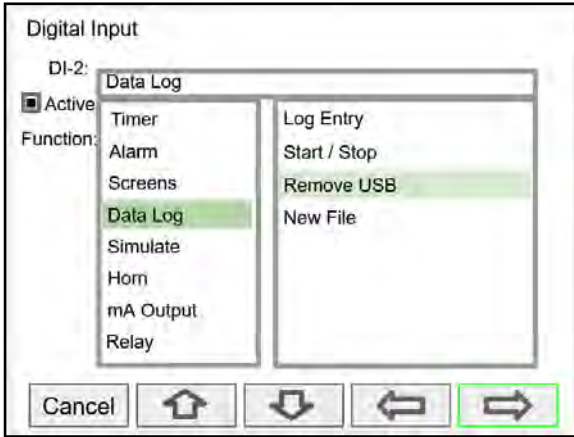

Modbus Functionality

The ConsoliDator+ supports Modbus RTU, Modbus ASCII, Enron Modbus, and Ethernet Modbus TCP/IP.

The *Server* mode is a standard ConsoliDator+ feature; it responds to requests and accepts writes from a Modbus client.

The *Client* mode can request process variables from server devices; the input variables can be scaled, combined with other variables using math functions, and they can be written to other server devices using the Modbus output functions.

The *Snooper* mode can listen and read the process variables being transmitted on the RS-485 bus without causing any disruptions to the network.

The *Spoofers* Modbus output is used to replace Modbus devices that have been removed from the network; there is no need to make changes to the Modbus client's configuration.

Setup Modbus Inputs (Server)

The Modbus *Server* mode is a standard ConsoliDator+ feature. The controller can accept up to 199 Modbus inputs sent by a Modbus Client. The inputs can be used as the source for channels, math functions, alarms, relay control, etc.

- Enter Modbus Input tag
- Type: Select the data type
The register number is displayed to the right
- Decimals: Number of decimals
- Units: Select units or enter custom unit
- Break: Value or condition for comm. break
- Timeout: Select timeout to detect break
- Input Action: Select action when new value is received (e.g. Add to Total 1 the value written)

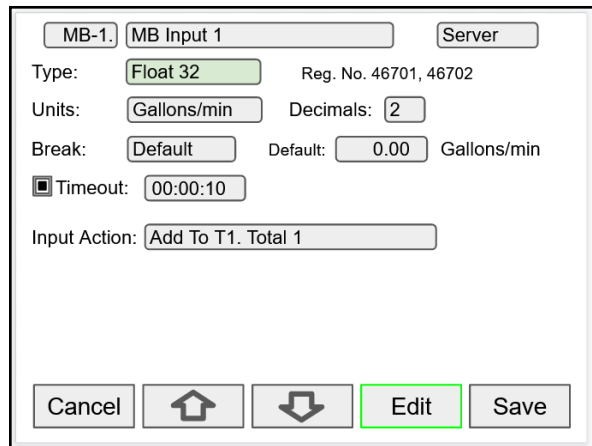

Data Types

- Bit – Logic (Coil)
- Signed/Unsigned 16 (Short), 32 (Long), 64 (Long Long)
- Float 32, Float 64 (Double)

IMPORTANT

- A controller configured as a Modbus Client can accept Modbus inputs as a Server via the Ethernet Modbus TCP/IP connection.
- The Modbus TCP/IP connection does not use a Server ID.
- The Modbus Client does not have a Modbus network ID because only one client is allowed on a Modbus network.

Setup Modbus Inputs (Client)

The PDK9000-M1 Modbus Client, Snooper & Spoofer *Add-On Feature*, when ordered with the ConsoliDator+, will be activated at the factory. This Add-On feature can also be ordered for existing ConsoliDator+ units with firmware version 2.1 or greater at any time. The user will receive a key that can be entered into the ConsoliDator+ to unlock the Add-On feature. See page 139 for instructions on how to enable the *Add-On Features*.

The controller can request up to 199 Modbus values, as inputs from other Modbus devices. The inputs can be used as the source for channels, math functions, alarms, relay control, etc.

- Enter Modbus Input tag
- Mode: Select Client
- Server ID: Enter the device ID to read from
- Address: Enter the register address to be read, the register number is displayed next to the data type
- Enron: Click on Enron to use Modbus Enron protocol
- Type: Select the data type
- Byte Order: Select the byte order for the data
- Units: Select units or enter custom unit
- Decimals: Number of decimals
- Break: Value or condition for comm. break
- Poll Time: Enter the time interval to poll the requested data, it is important to allow enough time to get all the data with each poll.
- Timeout: Select timeout to detect break if new data is not received after the poll.
- Input Action: Select action when new value is received (e.g. Add to Total 1 the value written)

Note: Make sure to set up the controller as a Modbus Client and configure the serial communication settings before trying to set up the Modbus Client inputs. See *Modbus Client Settings*, page 142 for details.

Data Types

- Bit – Logic (Coil)
- Signed/Unsigned 16 (Short),
- 32 (Long), 64 (Long Long)
- Float 32, Float 64 (Double)

Setup Modbus Inputs (Snooper)

The controller can read up to 199 Modbus values, as inputs from other Modbus devices being polled by a Modbus Client. The inputs can be used as the source for channels, math functions, alarms, relay control, etc.

- Enter Modbus Input tag
- Mode: Select Snooper
- Server ID: Enter the device ID to read from
- Address: Enter the register address to be read, the register number is displayed next to the data type
- Enron: Click on Enron to use Modbus Enron protocol
- Type: Select the data type
- Byte Order: Select the byte order for the data
- Units: Select units or enter custom unit
- Decimals: Number of decimals
- Break: Value or condition for comm. break
- Timeout: Select timeout to detect break if new data is not received within the specified time window.
- Input Action: Select action when new value is received (e.g. None, if not action is required)

Note: Make sure to set up the controller as a Modbus Server/Snooper and configure the serial communication settings before trying to set up the Modbus Snooper inputs. See *Modbus Snooper Settings*, page 142 for details.

Data Types

- Bit – Logic (Coil)
- Signed/Unsigned 16 (Short)
- 32 (Long), 64 (Long Long)
- Float 32, Float 64 (Double)

Setup All Outputs

The Setup Outputs screen is used to configure the hardware outputs, assigning a user-defined tag, scaling the mA outputs, associating relays with alarms, configuring the digital outputs, and assigning the Modbus outputs.

- mA Output: Configure analog outputs
- Relay Output: Configure relay outputs
- Digital Output: Configure digital outputs
- Modbus Output: Configure Modbus outputs

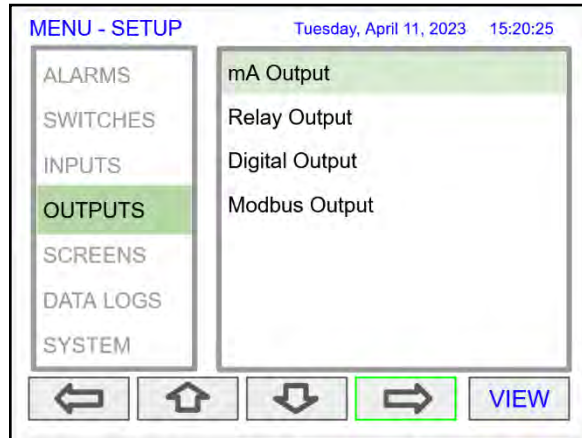

Setup 4-20 mA Outputs

The mA output can be assigned to any analog input, channel, alarm, or digital input. It can be scaled to any input and output value.

The top line indicates the slot # and position of the analog output (4a = slot #4, first position from the left). It also displays the actual mA output.

- AO-1: Analog output 1
- Input: Select source for the mA output
- Scale: Enter input and output values
- Break: mA output when sensor or communications break is detected
- Minimum: The minimum output allowed
- Maximum: The maximum output allowed
- Slew Rate: Rate of change in mA/sec
- Underrange: mA value when the PV goes below the low range value by more than 1%.
- Overrange: mA value when the PV goes above the high range value by more than 1%.

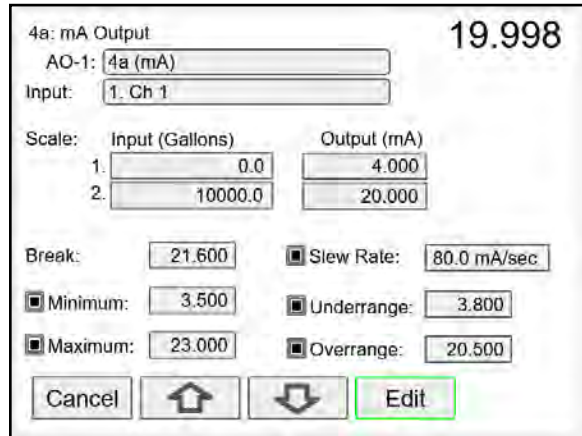

Setup Relay Output

The relays can be driven by alarms, digital inputs, Modbus inputs, channels, totals, and timers. If the input source is a channel, set and reset points must be entered. These are the available settings depending on the source selected.

- Input: Select the source to drive the relay
- Set & Reset: Enter values to turn on & off the relay for Channel, Total, or Timer Input
- Pulse Output: Pulse relay on/off when set is active
- Break*: The relay state when break is detected
- Fail-Safe: Relay energized under normal conditions
- Relay Status & Runtime: hh:mm:ss

*Function: Select **Other** to set relay to always on, always off, drive a relay-horn, or to alternate with another relay.*

Select the input source to drive the relay and enter the required parameters according to the input.

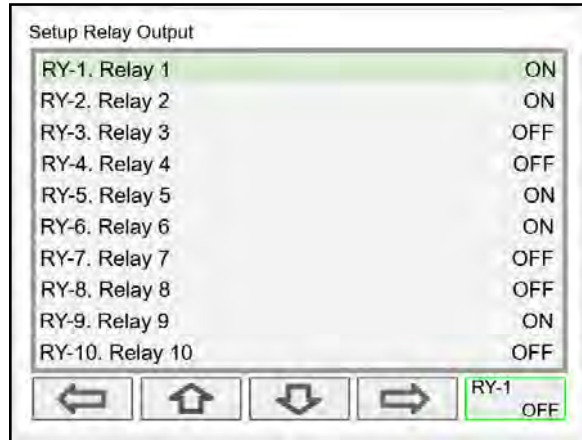

The F4 key can be used to momentarily turn on/off the relays. To manually control the relays, go to the View Menu to set the relay to be permanently on or off.

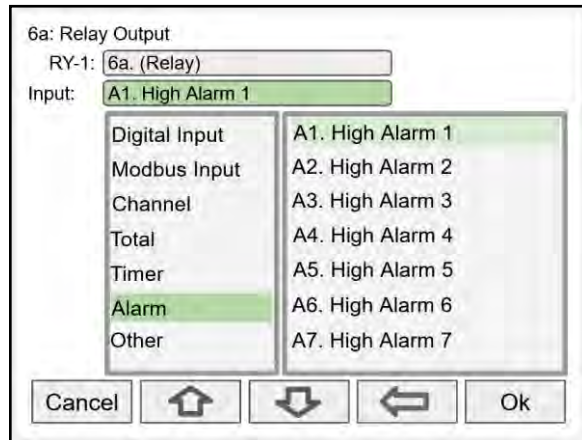

Relay Assigned to Alarm

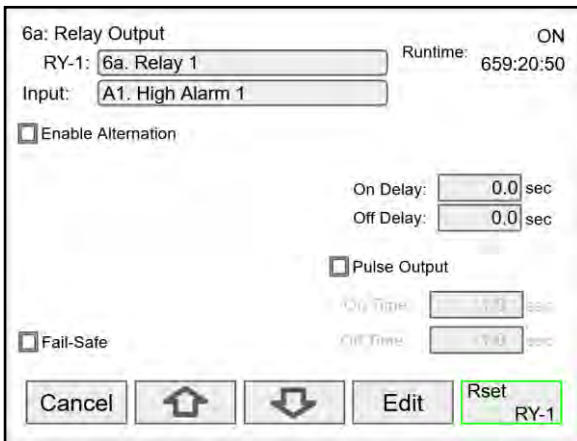

The relay runtime & cycle count can be reset (cleared) from the relay setup screen.

***Note:** Break needs to be set in the analog input menu.

Relay Assigned to Channel

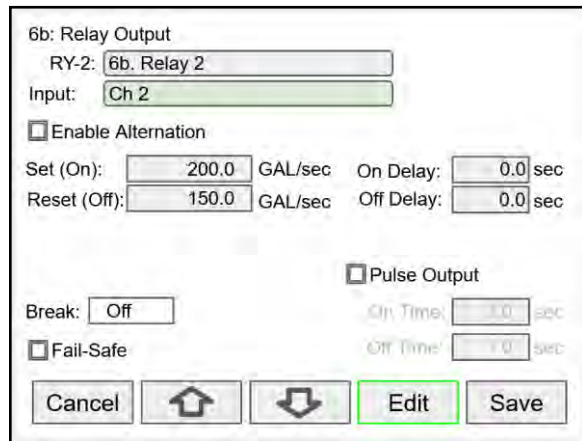

Relays not assigned to alarms are used for automatic on/off control based on set & reset point; they cannot be acknowledged.

Setup Digital Output

The Digital Output menu allows assigning the 4 outputs to various events generated by digital inputs, On/Off channels, alarms, and horn on state.

- Edit the digital output tag
- Select the input
- Select the Break condition
- Invert Output logic

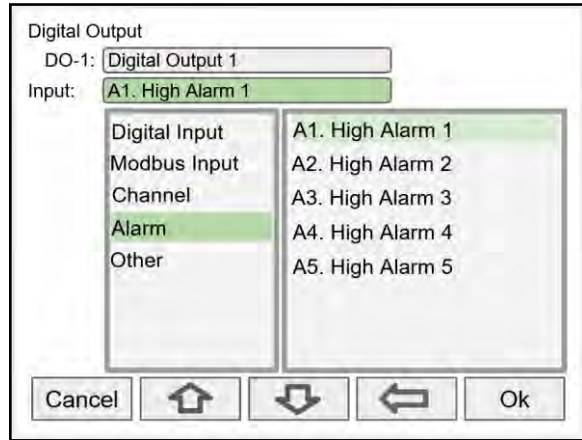

Setup Modbus Output (Server)

The Modbus output is a standard ConsoliDator+ feature; this is additional to the predetermined Modbus table provided, see *Modbus Register Tables* on page 163.

The *Modbus Output* menu allows assigning up to 99 Modbus register sets (1 to 4) to output any of the values available in the system (e.g. PV channels, Totals, Relay Runtime, etc.) and selecting the desired data type from bit-logic to float 64.

The function code is 0x03 and the registers are base-1 (e.g. Reg. Address 4400 = Reg. Number 44401).

- Edit the Modbus Output tag
- Select the source for the output
- Select the data type
- The register number is assigned by the system
- Engineering units
- Number of decimals
- Output Action

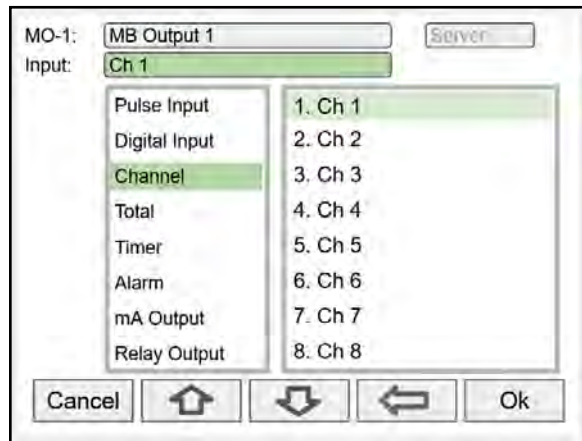

Select the input to be used for the Modbus Output

Additional Inputs not shown above:

- mA Input
- Digital Output

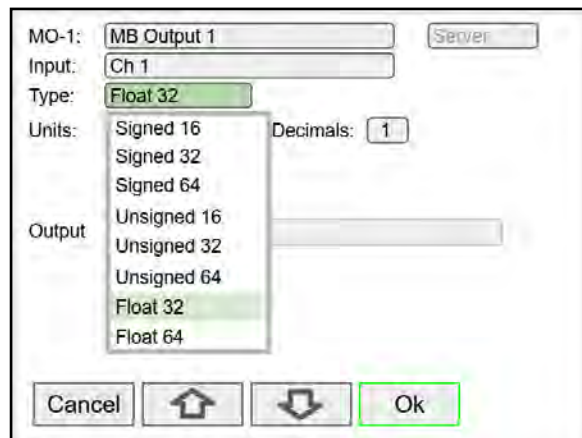

Select the data type

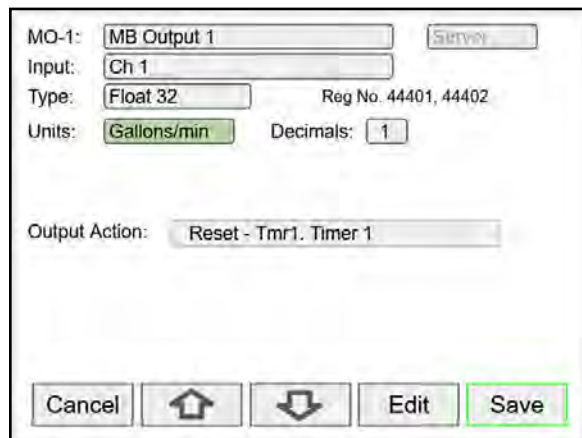

The register number is provided for each data type

Setup Modbus Output (Client)

The Modbus outputs from a ConsoliDator+ Client can be written to Modbus servers, or they can be read using the Ethernet TCP/IP port. The outputs are posted periodically on a schedule or on demand by triggering a user function (e.g. F1 function: Output (Post) - MO-1).

Process variables can be read by the Client, scaled, combined with other variables using the math functions, and the results can be written to another ConsoliDator+ or any other Modbus server, such as a digital panel meter.

The *Modbus Output* menu allows assigning up to 99 Modbus register sets (1 to 4) to output any of the values available in the system (e.g. PV channels, Totals, Relay Runtime, etc.) and selecting the desired data type from bit-logic to float 64.

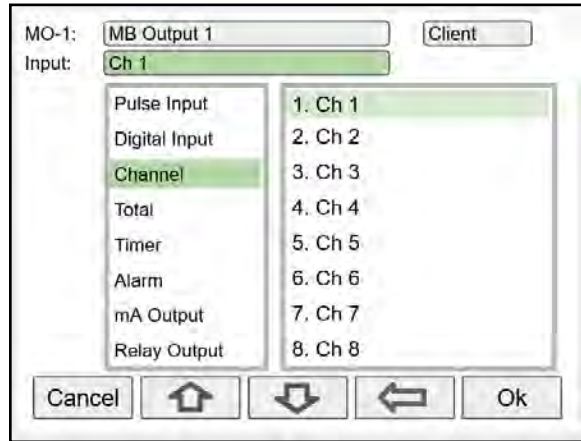

- Enter a tag for the process variable
- Select Client mode
- Select the input needed for the Modbus output

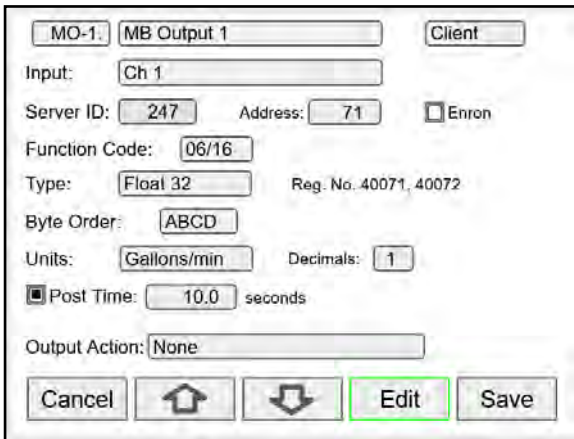

Enter all the parameters needed to write to a Modbus server (e.g. Modbus server panel meter)

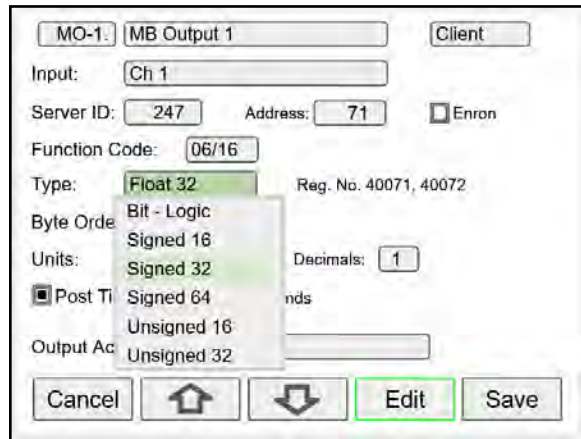

The data type must match the type required by the server device; otherwise the value will not be correct.

- Server ID
- Register Address (Base 0)
- Select Enron, if applicable
- Function Code
- Data Type – Reg. No. displayed automatically
- Byte Order
- Engineering Units and decimals to be used
- Post Time: How often to write to the server
- Output Action: Select from many actions available or leave as None

Setup Modbus Output (Spoofers)

The Modbus *Spoofers* mode is part of the PK9000-M1 Modbus Client, Snooper & Spoofers *Add-On Feature*. When ordered with the ConsoliDator+, it will be activated at the factory. This Add-On feature can also be ordered for existing ConsoliDator+ units with firmware version 2.1 or greater at any time. The user will receive a key that can be entered into the ConsoliDator+ to unlock the Add-On feature. See page 139 for instructions on how to enable the *Add-On Features*.

The Spoofers Modbus output is used to replace Modbus devices that have been removed from the network; there is no need to make changes to the client's configuration.

The *Modbus Output* menu allows assigning up to 99 Modbus register sets (1 to 4) to output any of the values available in the system (e.g. PV channels, Totals, Relay Runtime, etc.) and selecting the desired data type from bit-logic to float 64.

The supported function codes are: 0x01, 02, 03, 04. For outputting the value from a channel use function code 0x03, enter the registers address base-0 (e.g. Reg. Address 4400 = Reg. Number 44401).

- Edit the Modbus Output tag
- Select the source for the output
- Select the data type
- The register number is displayed automatically.

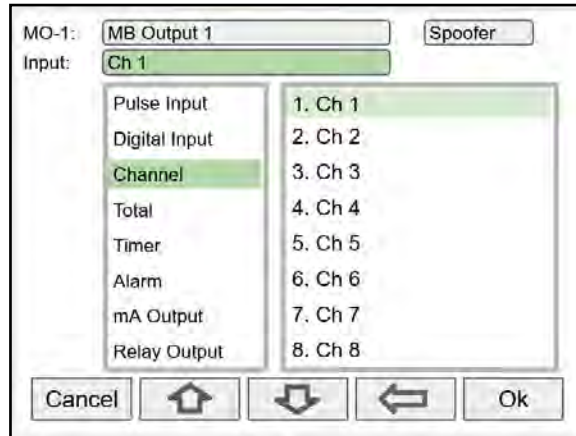

Select the input for Modbus Output.

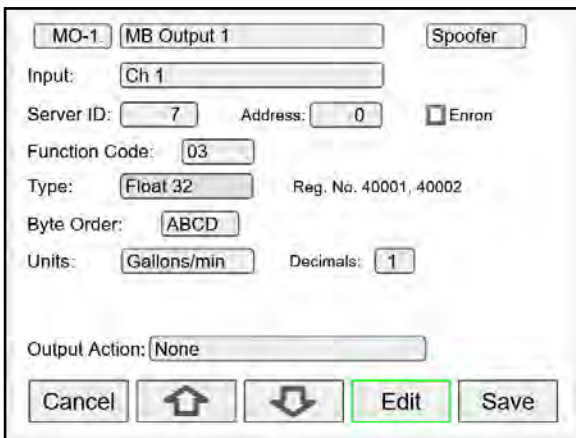

Select the data type.

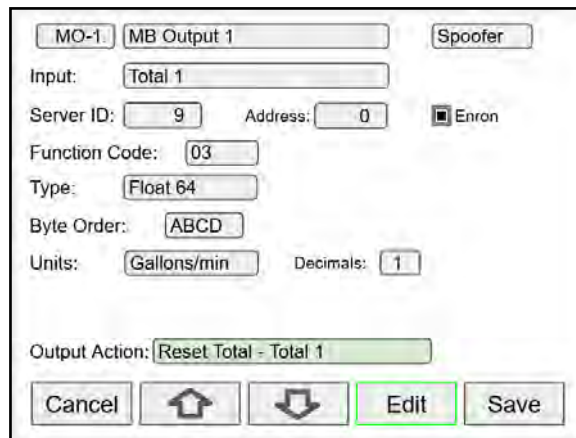

Enron protocol and Float 64 data type selected.

Every time the Modbus output is read by the client, the Total 1 is reset.

Setup Screens

The *Setup Screens* menu is used to set up the screens that will be displayed during operation and to set up the actions assigned to the function keys F1-F4.

Screens Settings

Up to eight PVs and/or alarms can be displayed per screen. The screens can be set up to scan automatically, display bargraphs, and program the function keys to be used while the screen is visible.

These are the available settings:

- Title: User-defined title or tag
- Channels and alarms: Up to eight/screen
- Show Title: Select to display the title
- Show Channel #: Select to display the channel #
- Show Bargraphs: Select to display the bargraphs
- Bargraph Only: Select to display only the bargraphs
- Auto Scan: Select to scan the screens automatically
- Dwell Time: Number of seconds the screen is displayed before moving to the next screen
- F1 – F4: Assign functions to be executed by the function keys

Notes:

1. The function keys F1 – F4 can be customized according to the screen in view.
2. If the Data Logger feature is enabled, the F4 key defaults to the Remove USB function.

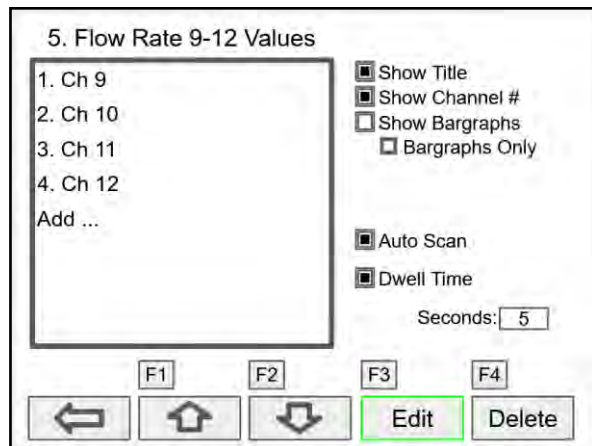
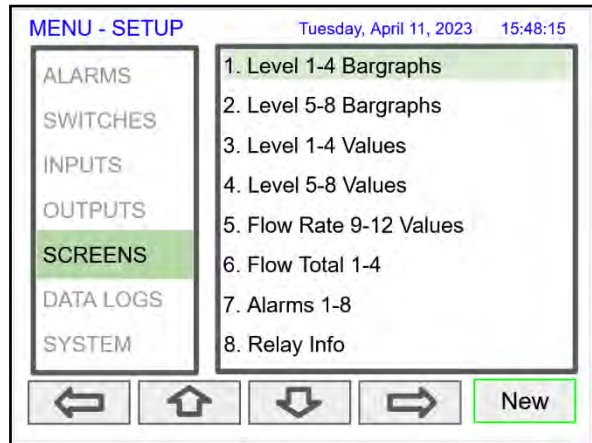

Setup Function Keys

The function keys are set up independently for each screen; this allows the customization of the function keys according to the process values being displayed. For example, if totals are being displayed, one function key can be set up to reset one or all totals.

Note: Functions are available for selection only if the appropriate parameter has been set up. Example: If there are no channels with Tare, Max, or Min, Channel will not appear in the list for selection of a function.

- Channel
 - Tare (If applicable)
 - Minimum
 - Maximum
- Total
 - Reset Total
 - Reset (Confirm)
 - Enter Total
 - Add To
 - Remove From
- Timer

Timer Control	Start (R) / Stop
Reset	Start / Stop
Start (Reset)	Start / Stop (R)
Start (No Reset)	Start (R) / Stop (R)
Stop (Reset)	Start / Reset
Stop (No Reset)	Stop / Reset
- Switch

Next	Pos. 1
Previous	Pos. 2
	Pos. 3
	Pos. 4
- Alarm
 - Ack
 - Reset Alarm
 - Set Points
- Screens

Previous Screen	View mA Input
Next Screen	View Pulse Input
Scan / Stop	View Digital Input
Go to Screen	View Modbus Input
View Channel	View mA Output
View Total	View Relay Output
View Timer	View Digital Output
View Alarm	View Modbus Output
View Date & Time	View Digital Output
	View Switch

Note: The View function can be used to go to any of the listed parameters or to the View screen for all parameters of the same type (e.g. View - all the channels).

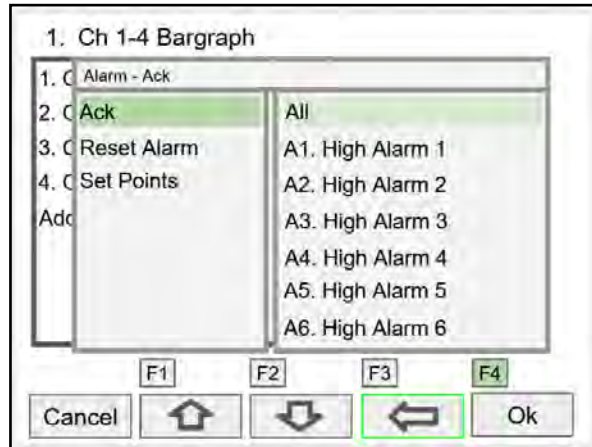

F4 Assigned to Acknowledge All Alarms

IMPORTANT

- If the Data Logger feature is enabled, the F4 key is assigned to the Remove USB function by default. This can be changed anytime.
- Data Log
 - Log Entry
 - Start / Stop
 - Remove USB
 - New File
- Simulate
 - mA Input
 - Pulse Input
 - Digital Input
 - Modbus Input
 - Channel
 - Total
 - Timer
 - Alarm
- Horn
 - Silence Horn
 - Snooze Horn
 - Horn Test
- mA Output
 - Manual
 - Hold (Manual)
 - Automatic
 - Manual / Auto
 - Hold / Auto
- Relay
 - Reset Info
 - Reset Info (Confirm)
 - Force ON
 - Force OFF
 - Manual ON
 - Manual OFF
 - Hold (Manual)
 - Automatic
 - Manual ON / Auto
 - Manual OFF / Auto
 - Hold / Auto

Function Keys for Batch

- Batch Control
- Start
- Stop
- Start / Stop
- Start / Pause
- Pause / Stop
- Start Size
- Start Partial
- Set Preset
- Force On
- Force Off
- Force On / Off
- Force On / Auto
- Force Off / Auto
- Force Preclose
- Reset

Function Keys for Print

- Print Ticket
- Print Screen
- Printer Off / On
- Clear Printer

Setup Data Logs

The PDK9000-D1 Data Logger Add-On feature, when ordered with the ConsoliDator+, will be activated at the factory. This Add-On feature can also be ordered for existing ConsoliDator+ units with firmware version 2.2 or greater at any time. The user will receive a key that can be entered into the ConsoliDator+ to unlock the Add-On feature. See page 139 for instructions on how to enable the *How to Enable Add-On Features*.

The *Setup Data Logs* menu is used to configure settings that are used for logging data to an external USB flash drive. Any data parameter can be logged; up to 8 data logs can be created. Each data log can contain from 1 to 12 parameters.

⚠ IMPORTANT

- For specifications, refer to *Data Logger – USB Drive* on page 26.

Setup New Data Log

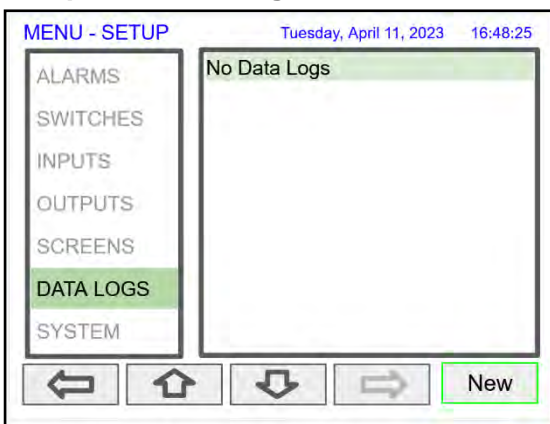

The setup of the data logs is easy, intuitive, and flexible. You can create logs that contain the same type of process data, or you can have a mix of just about anything you might want to log.

- Navigate to the *Data Logs* menu
- Press the *New* key (F4) to create a new log
- An untitled log is created: Enter a title for the log

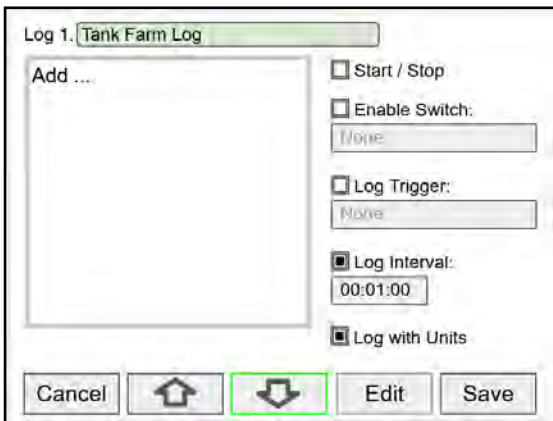

- Log #: Enter log file name
- Add: Add items to be logged
- Start / Stop: Control the log start & stop (optional)
- Enable Switch: Select an optional log control
- Log Trigger: Trigger log on a specific event (e.g. Channel – Schedule)
- Log Interval: Log at the specified interval
- Log with Units: Each log entry will have the corresponding engineering units

⚠ CAUTION

- Do not change the units for totals, while the data logger is running; the accumulated total will not be converted to the new units and the reflected value will not be accurate.

Add Items to Be Logged

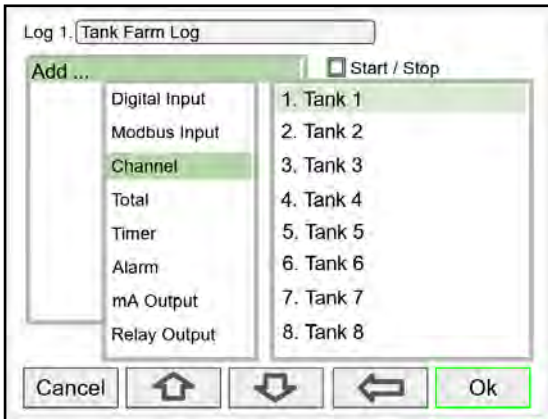

Each log can contain up to 12 process variables, inputs, outputs, timers, alarm status, relay status, or a combination of any of the following parameters:

1. mA Inputs
2. Digital Inputs
3. Modbus Inputs
4. Channels
5. Totals
6. Timers
7. Alarms
8. mA Outputs
9. Relay Outputs
10. Digital Outputs
11. Modbus Outputs

Setup Log Start / Stop

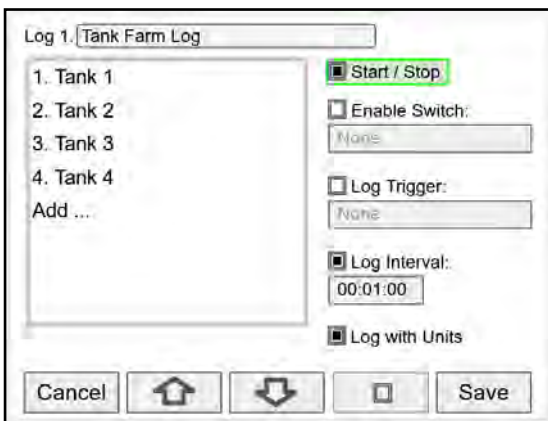

The log *Start / Stop* is used to give the system or the operator control to start and stop the log process.

The *Start / Stop* function is available in the *View Log* menu via the function keys.

The *Start / Stop* function can be activated with:

- Screen F1-F4 function keys
- Digital inputs
- Modbus inputs
- Modbus outputs
- Channel Control: Schedule, Sampler

Setup Log Enable Switch

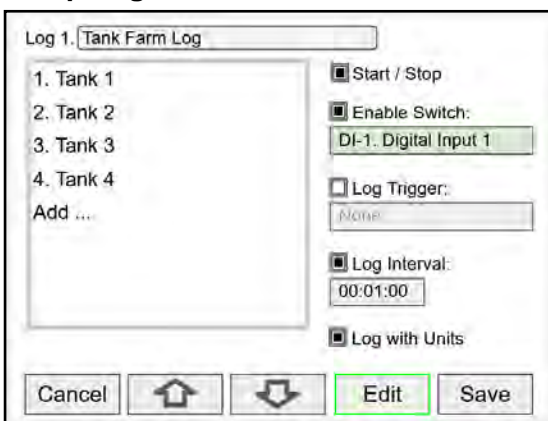

The log *Enable Switch* can be any item with a binary value (on / off, 0 / 1, true / false). Log entries will be made only if the Enable Switch is in the on position.

The Enable Switch input can be:

- Digital input
- Modbus input
- Channel
- Alarm
- Relay Output

Setup Log Trigger

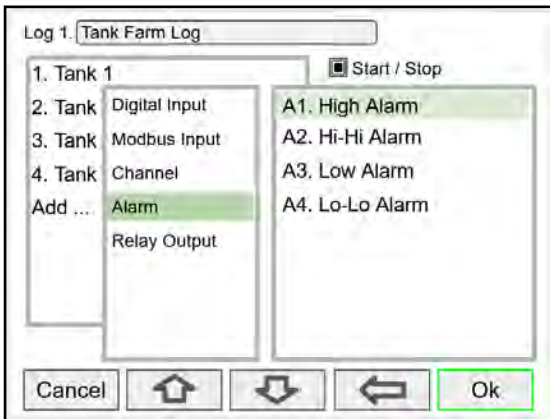

The *Log Trigger* can be any event from the list below. Log entries will be made every time the input is activated.

The *Log Trigger* input can be:

- Digital input
- Modbus input
- Channel
- Alarm
- Relay Output

The Modbus outputs can be used to trigger log entries.

Setup Log Interval & Log Units

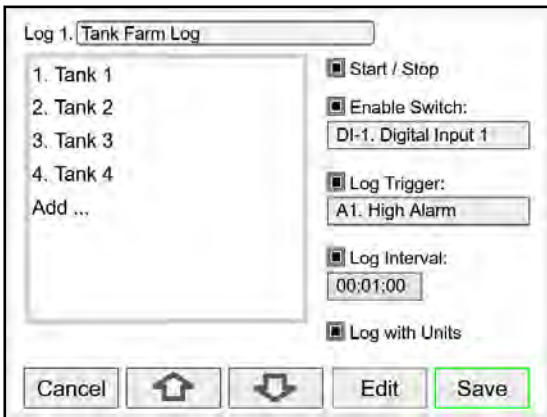

The *Log Interval* can be from 1 sec to 99:59:59 hh:mm:ss. Log entries will be made at the selected interval.

In this example the log must be started, and the digital input 1 must be on to log the tanks volume every minute.

To log continuously without the need to start or enable the log, deselect the *Start / Stop* and the *Enable Switch* settings.

If engineering units are not needed, deselect the *Log with Units* setting.

CAUTION

- If Start / Stop is enabled, the log will stop on a power cycle. Make sure to monitor if the power is turned off and re-start the log when the power is turned on.

Setup USB Drive

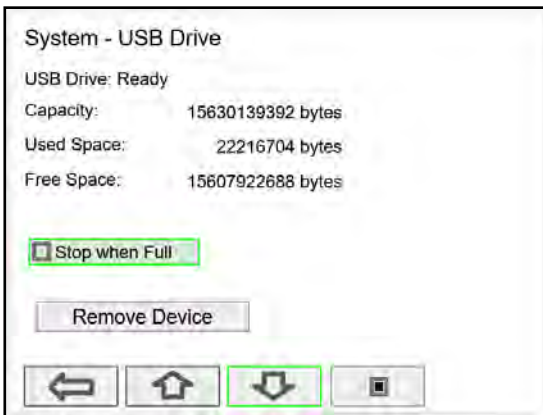

The *System – USB Drive* provides status information about the connected flash drive.

- USB Drive Status
- Capacity
- Used Space
- Free Space

Stop when Full: This should be selected, if the oldest logged data is more important than logging new data.

If *Stop when Full* is not selected, the oldest block of data will be deleted to make room for new data.

IMPORTANT

- The *USB Drive* menu is available only through the front panel.

Safely Remove Flash Drive

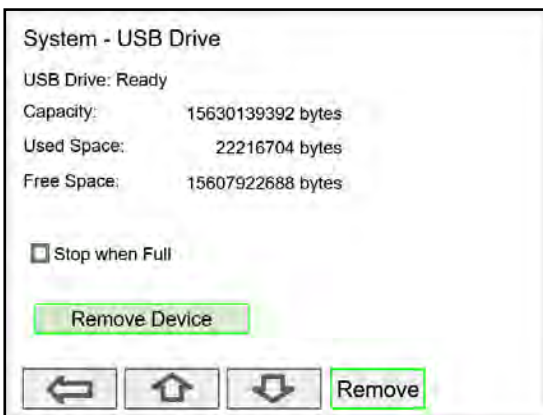

To safely remove the flash drive:

Go to the *System – USB Drive* screen, navigate to the *Remove Device* button using the down arrow key, then press the Remove key.

This procedure allows the USB drive to finish writing any log data in progress and prevent the lost or corruption of data.

The F4 key, in the Screens view, can be used to safely remove the USB drive without having to navigate to the *System* menu.



View Data Logs

In the *View Data Logs* menu you can see a list of the active data logs. Press the right arrow key to go to the log list and to see details of any of the logs.

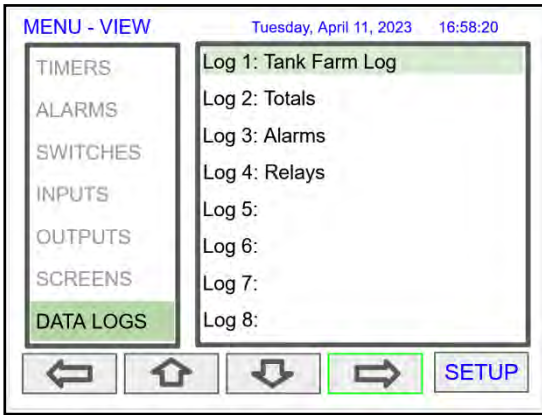

This screens shows a snapshot of the log in progress. If the log is not running, the screen will only show the log # and name. Press *Start Log* followed by *Log Entry* to capture the first log.

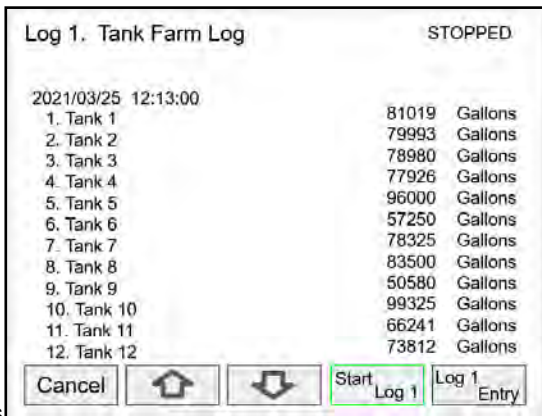
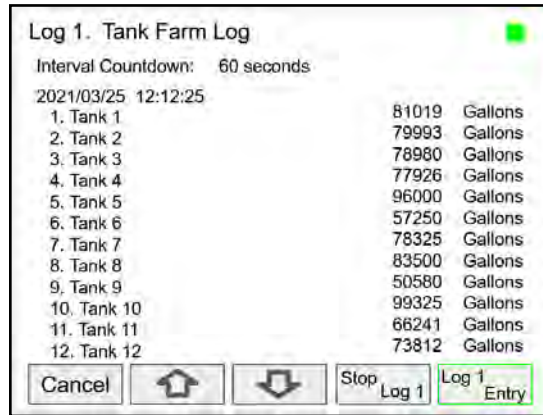

Press the *Stop Log* key to stop logging the selected log.

The *Start / Stop* function can be enabled or disabled during the log setup. This function is independent for each log.

After the log is started, the system will capture the first log according to the log setup selected.

The *Log Entry* key allows the user to capture a snapshot of the process any time.

IMPORTANT

- There is no provision for viewing previous log records on the screen. The flash drive must be removed and connected to a computer to download the saved logs.

Setup System

The *Setup System* menu is used to configure settings that are used throughout the system.

Setup Display

The System *Display* menu is used to adjust the display settings, setup colors for parameters, bargraphs, and alarms.

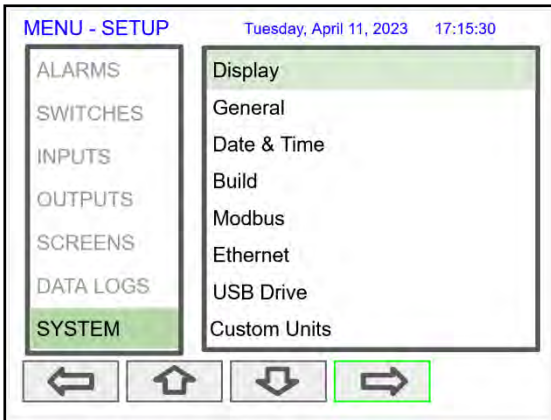

Setup Colors

The *Colors* menu is used to select the colors for text, values, and bargraphs associated with the parameter being displayed.

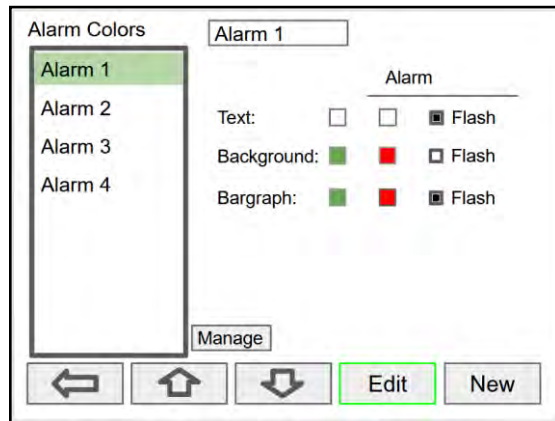
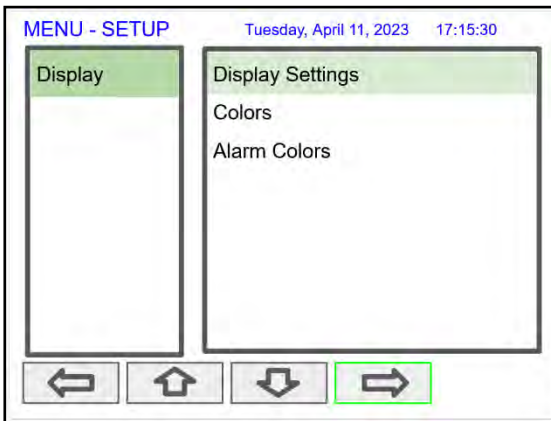
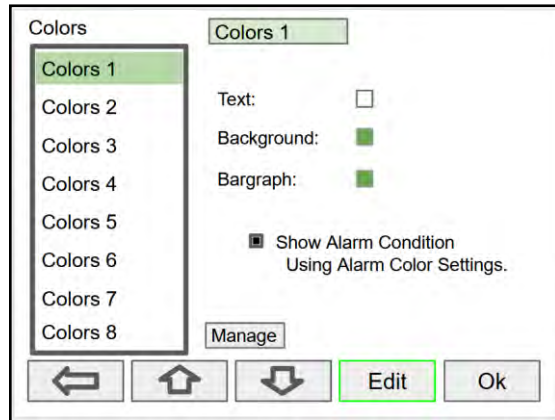

The *Alarm Colors* menu is used to select the colors and behavior of the alarms' text, alarm panel background, and the bargraph indicator for set and reset points.

Display Settings

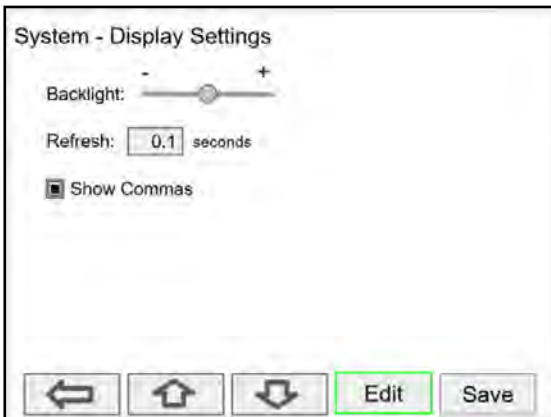

The *Display Settings* menu is used to adjust the backlight brightness, refresh rate and to enable or disable the display of commas for all numeric values.

General Settings

The *General Settings* menu contains the settings listed below.

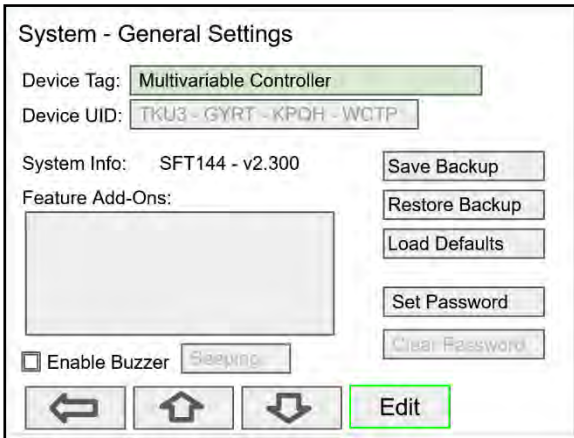
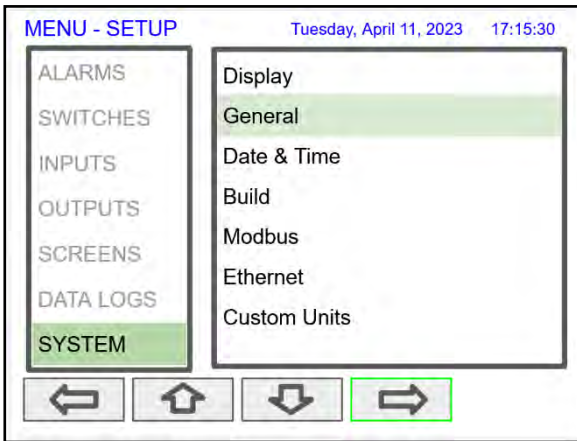

***Note:** The internal buzzer is associated with the alarm's Horn setting, which is available to drive any relay.

- Device Tag: Edit the device tag (saved on Enter)
- Device UID: Device unique ID
- System Info: Firmware number and version
- Feature Add-Ons: List of add-on features enabled. A unique key is needed to enable add-on features.
- Enable Buzzer: Enable/disable internal buzzer*
- Save Backup: The current configuration is saved
- Restore Backup: Load backup configuration
- Load Defaults: Load factory defaults
- Set Password: Enter password to lock the system
- Clear Password: Remove the current password

*Buzzer Options:

- Beeping
- Warble
- Alarm
- Solid
- Carousel

How to Enable Add-On Features

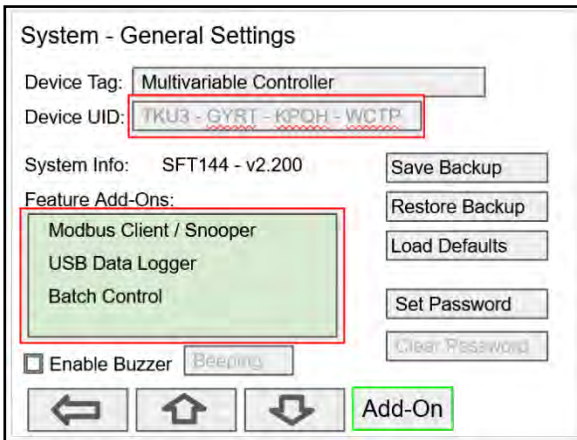

The Add-On Features can be enabled at the factory or they can be purchased and enabled by the user at any time. A unique key code is required to enable Add-On Features.

- P/N: PDK9000-M1 Modbus Client/Snooper (Ver. 2.1 & up)
- P/N: PDK9000-D1 USB Data Logger (Ver. 2.2 & up)
- P/N: PDK9000-B1 Batch Control (Ver. 2.4 & Up)

To purchase an Add-On Feature, follow these steps:

1. Obtain the Device UID (Unique ID), the graphic to the left shows the location of the Device UID.
2. Place an order for PDK Add-On Feature(s) and provide the Device UID.
3. A unique key code will be sent to you.
4. Go to the *System - General Settings*.
5. Navigate to the *Features Add-Ons* area.
6. Press the *Add-On* key and enter the unique alphanumeric key received.
7. The added feature will be displayed in this window. Press any arrow key to move to other settings or exit.

Set Password

The user may enter a 4-digit password to protect the system from unintentional changes.

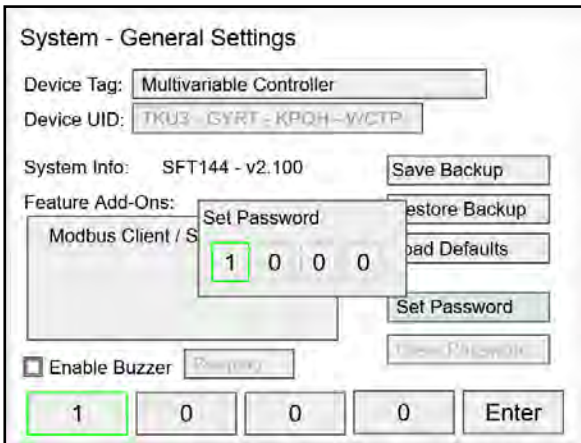
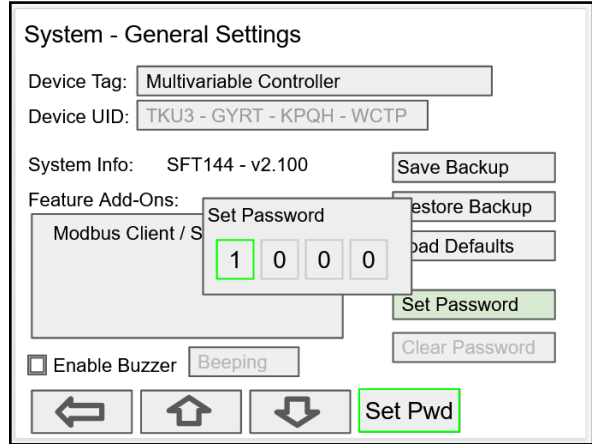
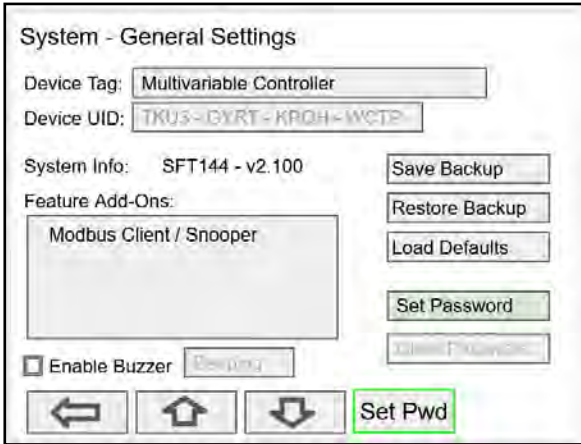

Password Protected Controller

The correct 4-digit password is required to make changes to the system.

If the password is not correct after 3 attempts, the system will not allow new tries until a timeout elapses. The timeout will continue increasing for every 3 new unsuccessful tries.

Note: If the controller is password protected and the password has been forgotten, the password may be overridden using the master password: **1974**

Remove Password Protection

To remove the password protection:

1. Enter the correct password
2. Go to the **System** menu – **General Settings**
3. Navigate to the **Clear Password** button
4. Press the **Clr Pwd** key

CAUTION

- The function keys and the digital inputs are not password protected.

System Date & Time

The date & time of the system can be easily adjusted in the System menu.

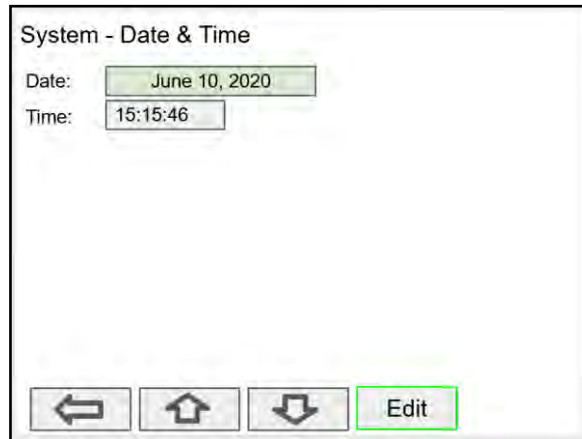

System Build

The *Build* menu provides the model number, and it shows the I/O cards installed with their location in the seven available slots.

If an I/O card is removed permanently, pressing the *Rebuild* key clears the information from the slot. This should also be done if a different card is installed.

Replacing I/O Cards

In case an I/O card fails, follow these steps:

- 1) Save a backup copy of the configuration
- 2) Remove the defective card
- 3) Install the new card in the same slot where the defective card was.
- 4) It is not necessary to press Rebuild.

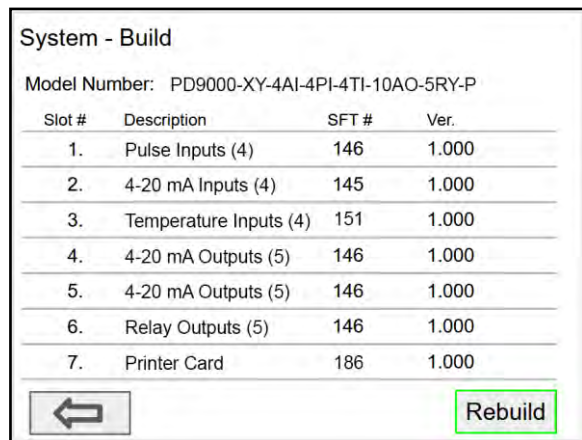

Modbus Server Settings

The *Modbus Server* settings must match the settings of other devices on the bus. The Modbus ID must be unique for each device on the bus.

Modbus Write Protection

Select **Passcode** and enter a Modbus passcode between 0 and 9999 to prevent unauthorized writes to the controller.

Note: The Modbus passcode is different than the main password used to protect access to the Setup and View menus.

System - Modbus Settings

RS-485 Settings:

Mode: Server ID:

Baud Rate: ASCII

Parity:

Tx Delay: ms

Server Settings:

Passcode:

Buttons: Cancel, Home, Back, Ok

Modbus Client Settings

The *Modbus Client* settings must match the settings of other devices on the bus.

The Rx Timeout is used for devices that are slow to respond, such as wireless Modbus servers.

Modbus Write Protection

Select **Passcode** and enter a Modbus passcode between 0 and 9999 to prevent unauthorized writes to the controller.

Note: The Modbus passcode is different than the main password used to protect access to the Setup and View menus.

System - Modbus Settings

RS-485 Settings:

Mode: ASCII

Baud Rate:

Parity:

Tx Delay: ms Rx Timeout: seconds

Server Settings:

Passcode:

Buttons: Cancel, Home, Back, Edit, Ok

Modbus Snooper Settings

The *Modbus Snooper* settings must match the settings of other devices on the bus. The Snooper also works as a server, responding to requests from a Modbus client. A unique server ID must be assigned to it.

The Rx Timeout is used for devices that are slow to respond, such as wireless Modbus servers.

Modbus Write Protection

Select **Passcode** and enter a Modbus passcode between 0 and 9999 to prevent unauthorized writes to the controller.

Note: The Modbus passcode is different than the main password used to protect access to the Setup and View menus.

System - Modbus Settings

RS-485 Settings:

Mode: Server ID:

Baud Rate: ASCII

Parity:

Tx Delay: ms Rx Timeout: seconds

Server Settings:

Passcode:

Buttons: Cancel, Home, Back, Edit, Save

Modbus Monitor

The *Modbus Monitor* is used to monitor traffic going through the PD9000 as a client.

Description of each column:

- **First column** represents the time between reads and writes
- **Second column** will either be R or W.
R = Read W = Write
- **Third column** is the function code of that register
- **Fourth column** is the Server ID
- **Fifth column** is the register being read or written to
- **Sixth column** is the action status, which is either going to show OK, FAIL, or TIMEOUT

System - Modbus Settings

RS-485 Settings:

Mode: ASCII

Baud Rate:

Parity:

Tx Delay: ms Rx Timeout: second

Server Settings:

Passcode:

Button operation:



Pause the monitoring, however the Modbus actions will continue in the background. The monitoring will continue when RESUME is pressed.



The **UP** and **DOWN** arrows will allow you to scroll through the history when the monitoring is paused.

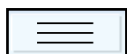

Shortcut to either the View Modbus Input or View Modbus Outputs screens.

Modbus Monitor: RS-485 Client

12.22	R	03	247	0000,0001	OK
17.30	R	03	247	0000,0001	OK
22.37	R	03	247	0000,0001	OK
27.45	R	03	247	0000,0001	OK
32.53	R	03	247	0000,0001	OK
37.61	R	03	247	0000,0001	OK
42.69	R	03	247	0000,0001	OK
47.77	R	03	247	0000,0001	OK
52.85	R	03	247	0000,0001	OK
57.92	R	03	247	0000,0001	OK
63.00	R	03	247	0000,0001	OK
68.09	R	03	247	0000,0001	OK
73.16	R	03	247	0000,0001	OK
78.24	R	03	247	0000,0001	OK

Ethernet Settings

The *Ethernet* menu provides basic information about the Ethernet port and allows the user to program a static IP Address, the port number, and the protocol to be used.

The settings provided in the *System* menu are sufficient to establish Ethernet communications using the TCP or UDP protocols.

For more advanced setup, refer to the instructions provided under *Ethernet Port Setup* on page 146.

Note: If DHCP is selected, the device obtains a new IP address automatically most of the time when the power is cycled. The dynamic IP address is not displayed on the controller.

Dynamic Host Configuration Protocol (DHCP) is a network management protocol used to automate the process of configuring devices on IP networks, thus allowing them to use any communication protocol based on UDP or TCP.

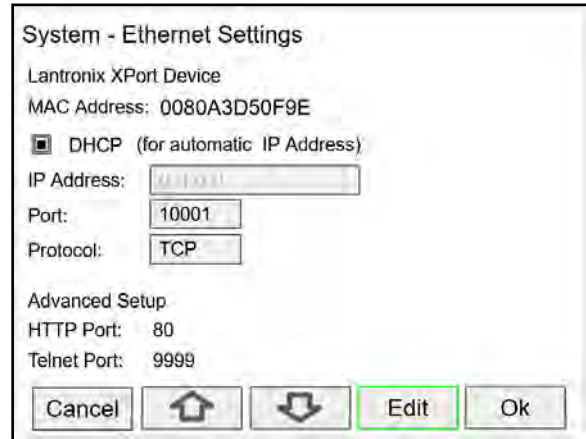

IMPORTANT

- The *Ethernet* menu is available only through the front panel, and only if the option is installed.

Manually Assigned IP Address

To assign a static IP address, you must obtain it from your network administrator.

Uncheck the DHCP box and enter the IP Address.
 Port: Do not change unless directed by IT administrator
 Protocol: Select TCP or UDP

Advanced Setup settings is for information only.
 For complete setup of the Ethernet port, follow the instructions below.

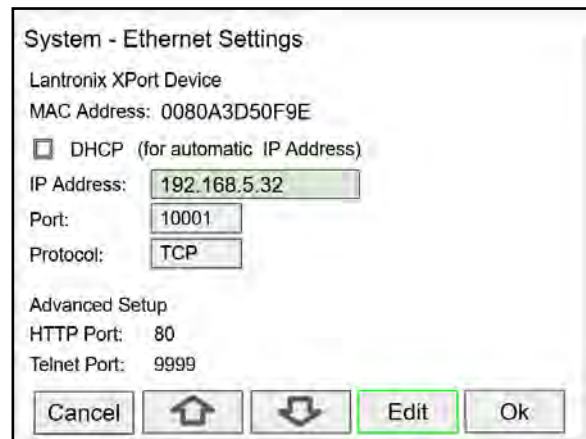

USB Drive Settings

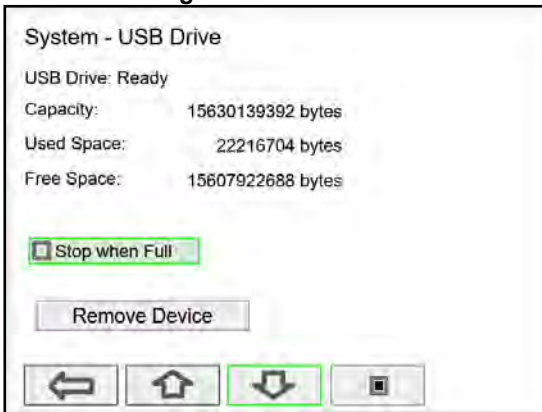

The *System – USB Drive* provides status information about the connected flash drive.

- USB Drive Status
- Capacity
- Used Space
- Free Space

Stop when Full: This should be selected, if the oldest logged data is more important than logging new data.

If *Stop when Full* is not selected, the oldest block of data will be deleted to make room for new data.

IMPORTANT

- The *USB Drive* menu is available only through the front panel.

Custom Units

Custom units can be created either in the System menu or when a parameter is created in the Setup - Channels menu. Follow these steps to create a custom unit:

- Go to the System menu – Custom Units
- Select New
- Enter a label for the unit (8 characters max)
- Select the unit type or None
- Select the base unit
- Enter the conversion factor

Examples:

- For 5-gallon bottles, the factor is 0.2 (1/5 = 0.2)
- For one billion gallons, the factor is 0.000000001 (1/1,000,000,000)

Note: The factor is saved as a Float and it is displayed as 6 significant digits. Internally it saves the precise number entered, with single floating point precision (e.g. The value 3.785412 is displayed as 3.78541, but internally 3.785412 is used for calculations).

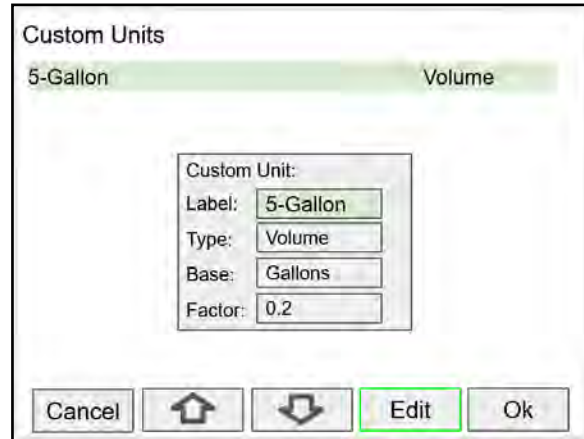

IMPORTANT

- The custom units can be used to create units in other languages or to create alternative spellings (e.g. L to Litros).

Delete Custom Units

Custom units can only be deleted if they are not used anywhere in the system.

To delete a custom unit go to the System – Custom Units menu, simply select the unit, navigate to the Delete button, and press Ok to delete.

The Delete button is not available if the custom unit is being used.

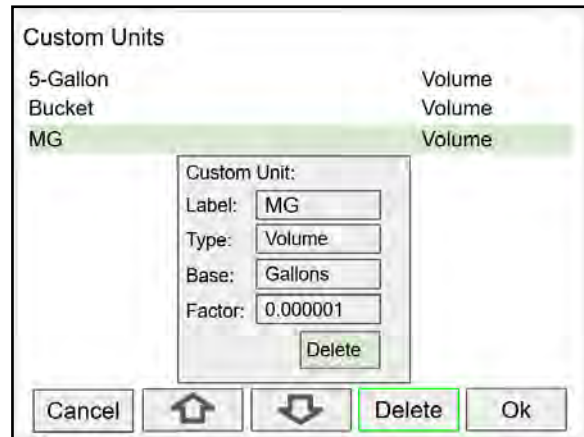

Ethernet Port Setup - Full

The Ethernet port option is fully configured using the Lantronix DeviceInstaller software, available for download from the Lantronix's Website. <https://www.lantronix.com/products/xport>

Follow these steps, after installation of the DeviceInstaller software:

1. Connect an Ethernet cable to the Local Area Network
2. Launch the Lantronix DeviceInstaller; it will search for XPort devices on the Local Area Network (LAN) and display their status.
3. If no controller is found, click on **Options**, and select the type of connection being used (e.g. Wi-Fi).
4. If more than one controller is connected to the network, determine which is the new controller by the assigned IP address. If necessary, disconnect the new controller and click **Device – Search**, take note of the IP addresses listed. Next, connect the new controller to the LAN and repeat the search; check the list to see which the new IP address is.

CAUTION

- Consult with your IT department to configure the Ethernet port and maintain network security.



5. Double-click on the new device IP Address to be configured.

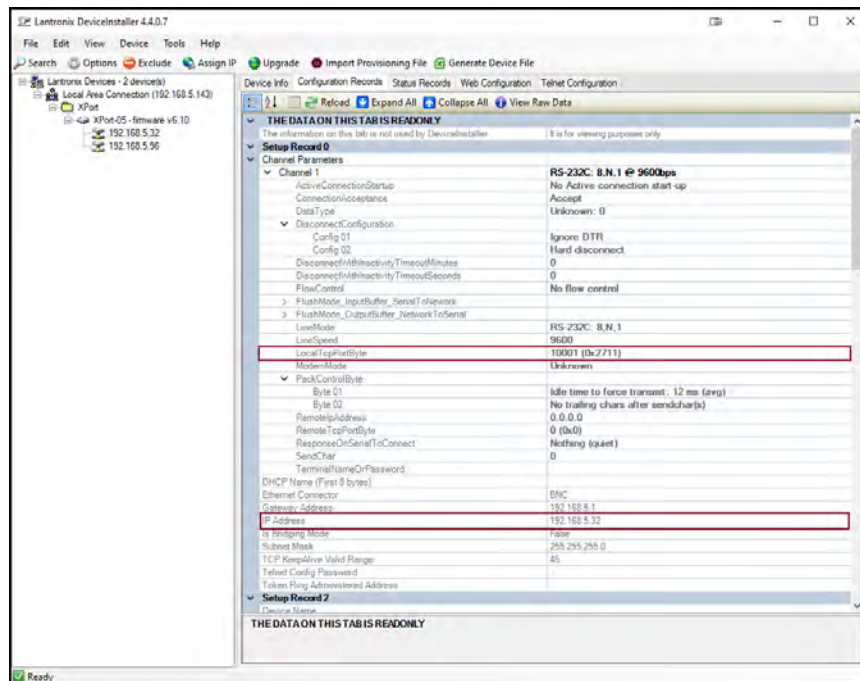

To communicate with a device connected over a LAN, you need the IP Address and the Local TCP Port.

6. Click on **Configuration Records** to find these settings, see the example above.
IP Address: 192.168.5.32; Local TCP Port: 10001 (0x2711)

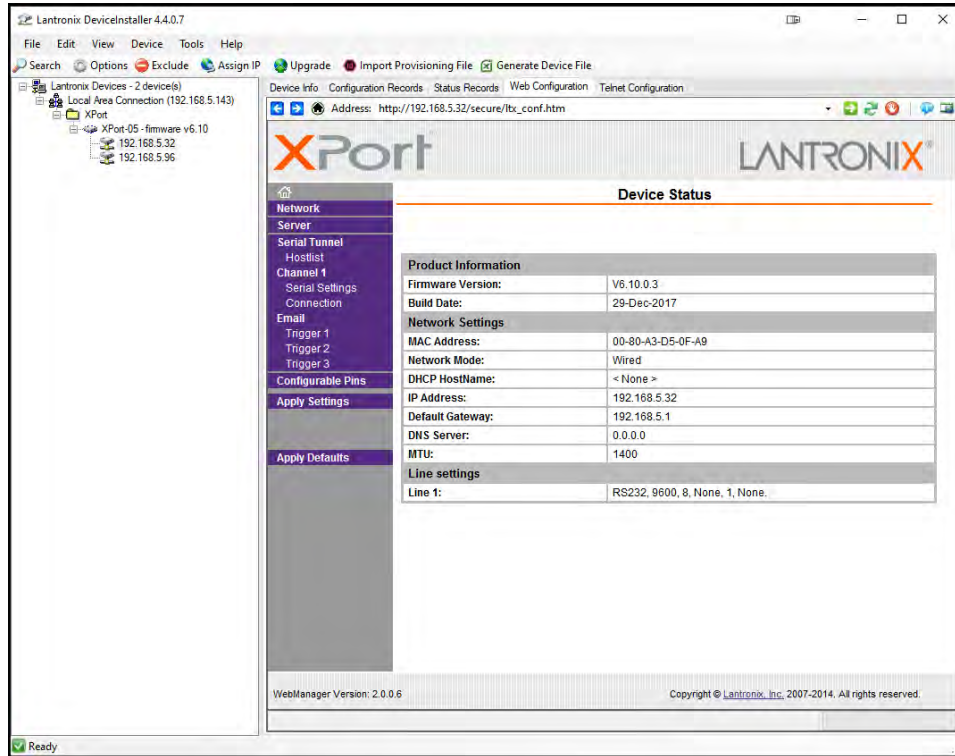

7. Click on **Web Configuration**

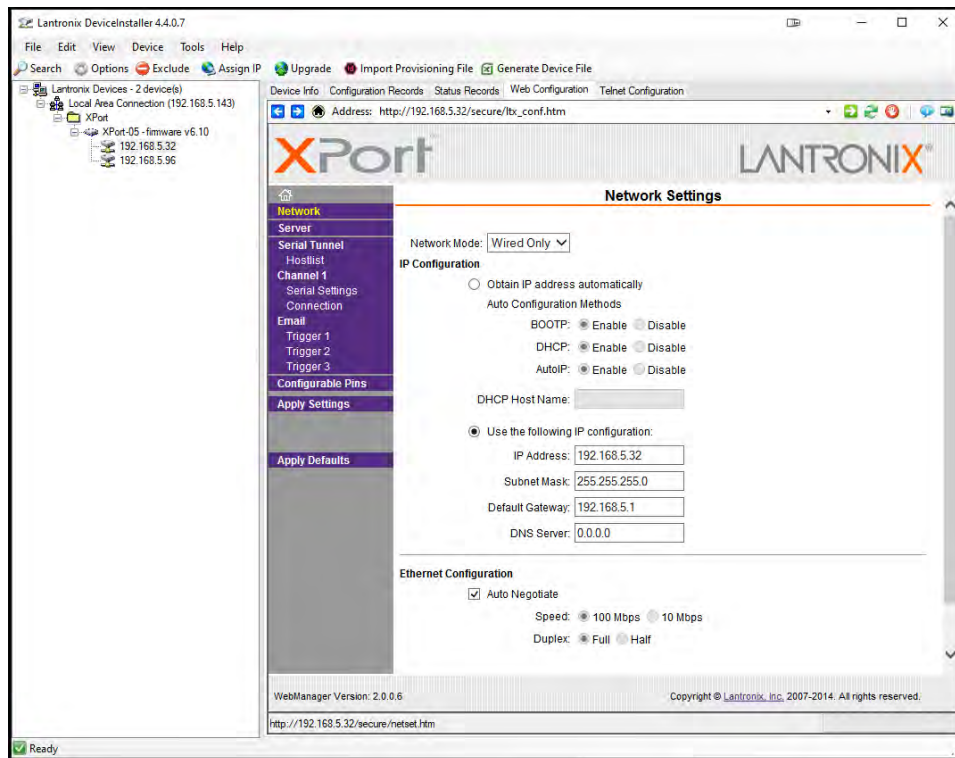

- Click on **Network** to assign a new IP Address

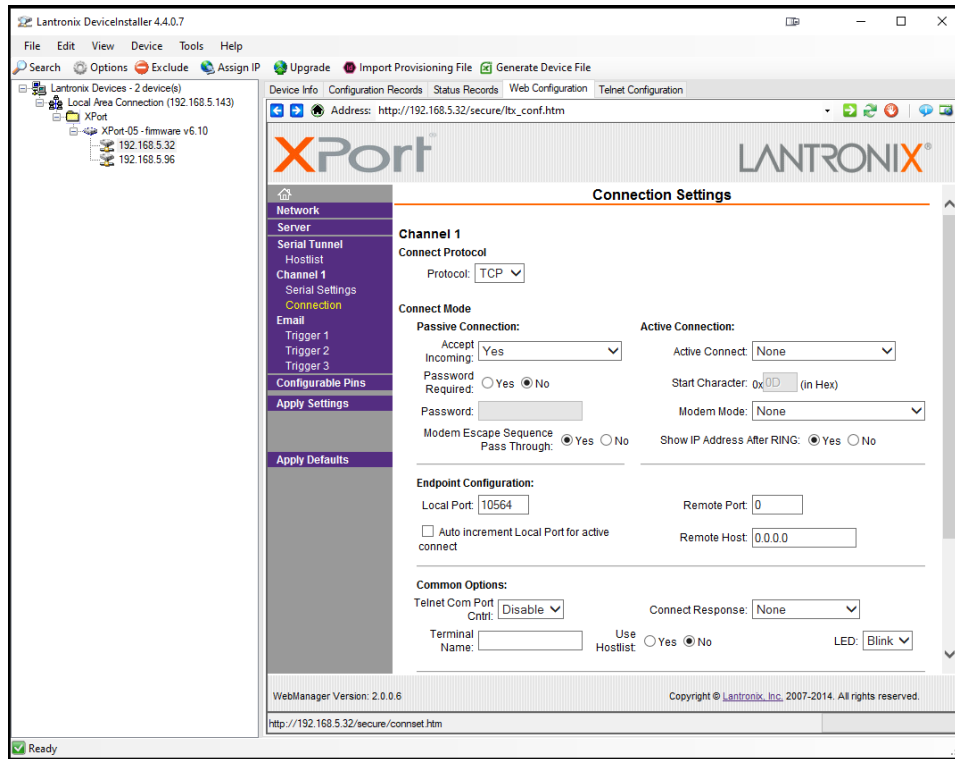

- Click on **Channel 1 – Connection** to select the protocol: TCP or UDP.
Note: For UDP protocol, select **Datagram Type:** 01
- Under **Endpoint Configuration**, enter the **Local Port** to be used to access the controller locally or from a remote location. This should be provided by your company’s IT department.
- Click **OK** and then click **Apply Settings** for settings to be sent to the Ethernet device.

Test Ethernet Communication

Modbus Poll is an app that makes it easy to test your Ethernet connection. Below are some screenshot examples for Modbus TCP/IP connection.

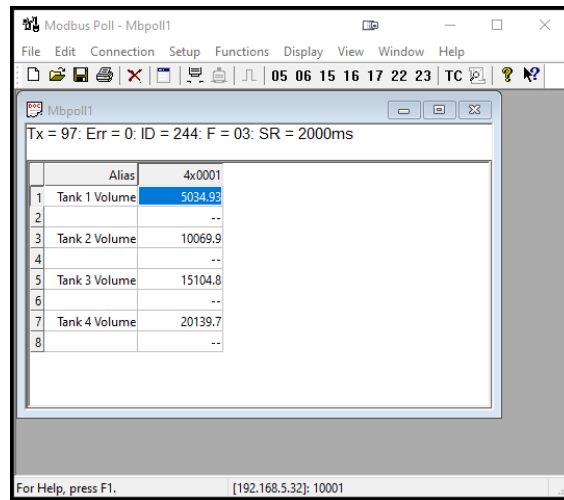
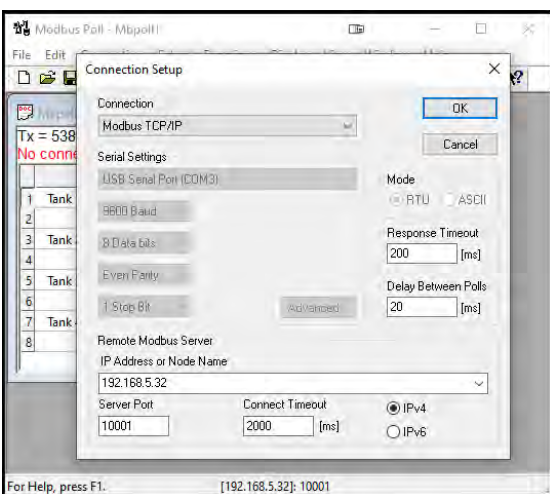

Note: You may download a free trial copy of Modbus Poll from <https://www.modbustools.com/>

View Menu

The *View* menu is used to view individual channels, totals, timers, alarms, inputs, outputs, and screens. For example, it provides the details for the current PV, what inputs are the sources for the channel and what outputs are associated with the channel.

Accessing the individual parameters through the *View* menu also allows the simulation of the various parameters for testing purposes as well as the manual control of the relays, analog outputs, timers, alarms, and the reset of totals.

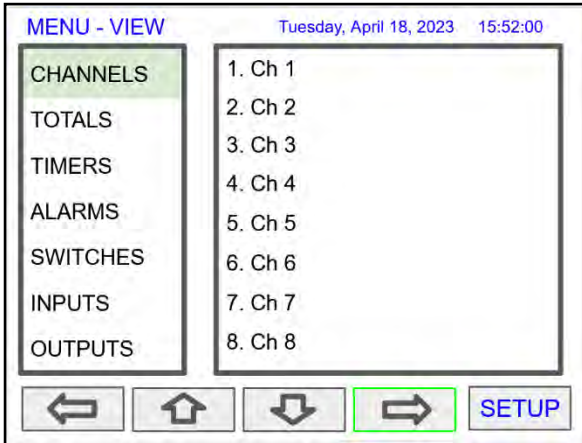

Press the **Right Arrow** key to step into viewing any channel.



Select any channel using the **Up** or **Down Arrow** keys and Press the **Right Arrow** key again to step into viewing the channel details.

View Channel Details

Stepping into a channel allows the viewing of additional details for the inputs and outputs associated with that channel. It is also possible to simulate the selected parameter.

- Channel number and tag
- PV and units
- View the channel input source
- View alarms associated with channel
- View analog outputs assigned to channel
- Simulate the channel or analog input
- Step into any associated parameter

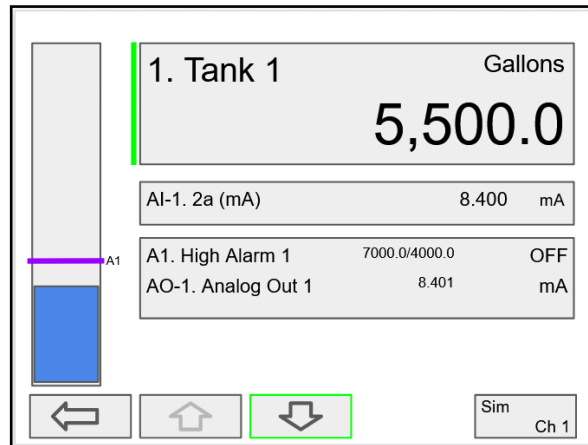

Press the **Down Arrow** key to navigate to the channel input source and then down again to view alarms and analog outputs.

View Associated Parameters

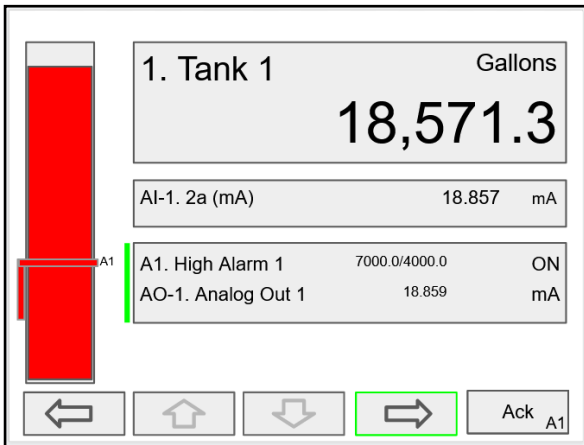

Press the **Right Arrow** key to select the alarm.

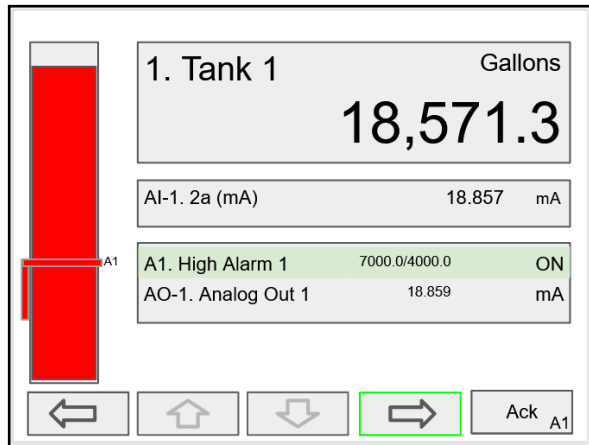

Press the **Right Arrow** key again to view alarm's details.

View Alarm Details

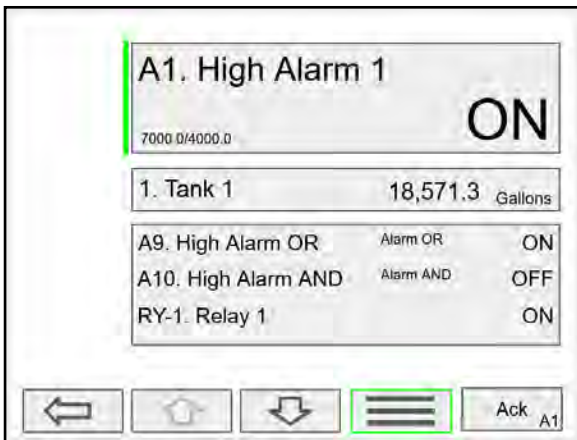

Press the **3-Bar** key to access the available options.



Alarm view options: acknowledge alarm, reset alarm, change set/reset points, and simulate an alarm condition.

View Batches

The *View Batches* menu displays the status and value of the batches and allows resetting of batch size.

- Batch number and tag
- Status of batches (Running, stopped, or finished)
- Accumulated batch and units
- Batch control screen shortcut
- Right arrow to view selected batch details and associated elements for that batch, including:
 - Inputs
 - Channels
 - Alarms
 - Relays

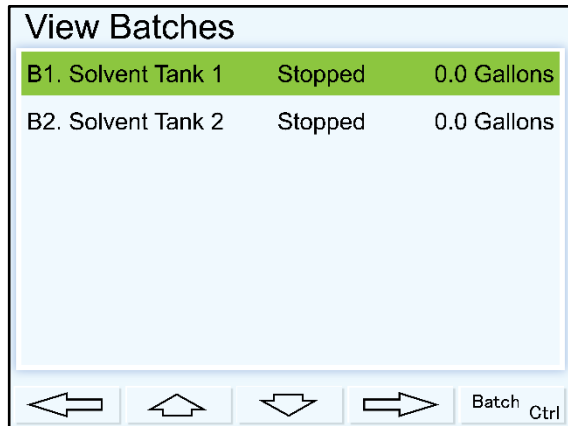

Press **Right Arrow** key to step into details of the selected batch and view the source and associated outputs.

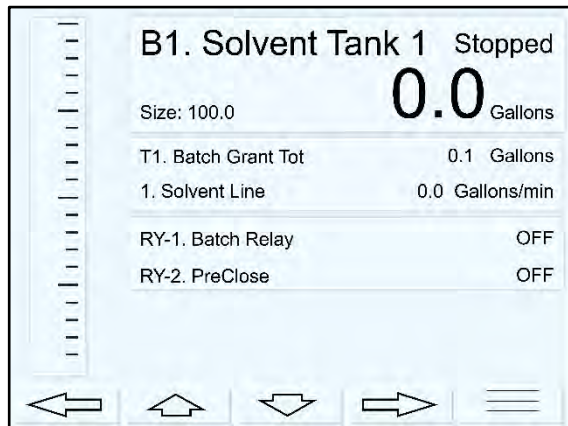

Press **Right Arrow** key to step into details of the selected batch and view the source, alarms, and associated outputs.

View Totals

The *View Totals* menu displays the value of all the totals and allows resetting each total individually.

- Total number and tag
- Accumulated total and units
- Reset total key
- View source for total
- View alarms associated with total
- View analog outputs assigned to total

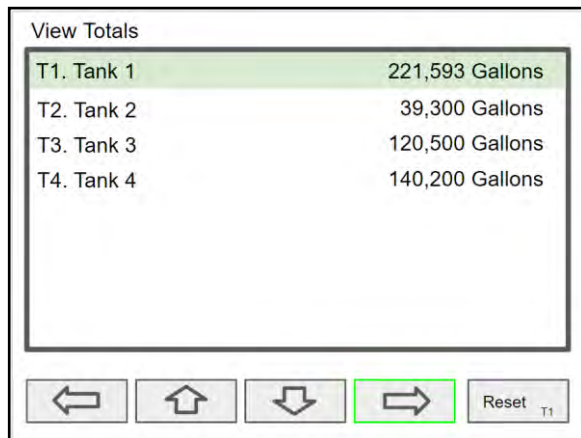

Press **Right Arrow** key to step into details of the selected total and view the source and associated outputs.

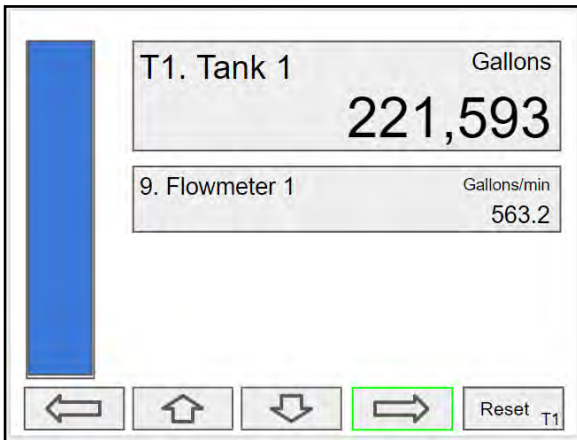

Press the **Right Arrow** key to select Total 1.

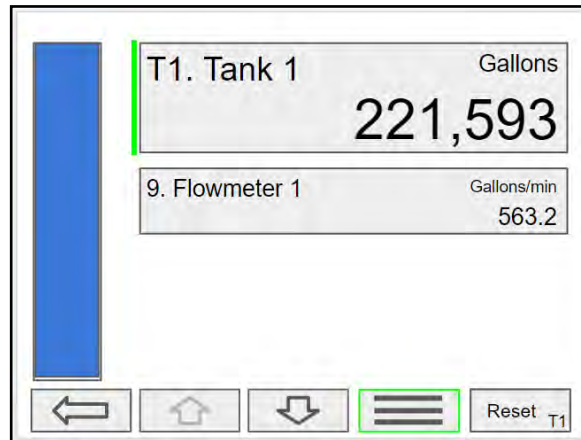

Press the **3-Bar** key to enter a new total, reset the total, or simulate a value for the total.

Totals not associated with a rate channel have additional features: Add to or remove from the total.

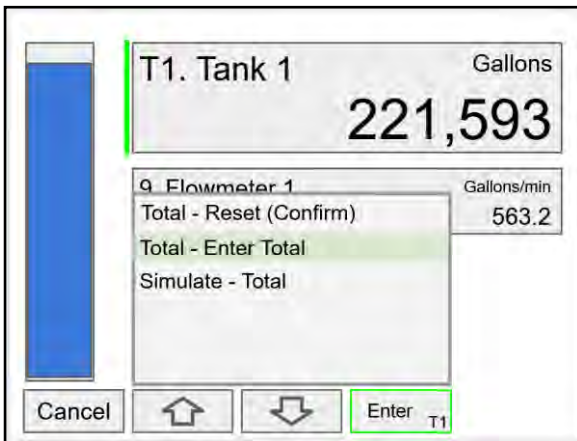

Press the **Enter** key to enter a new total.

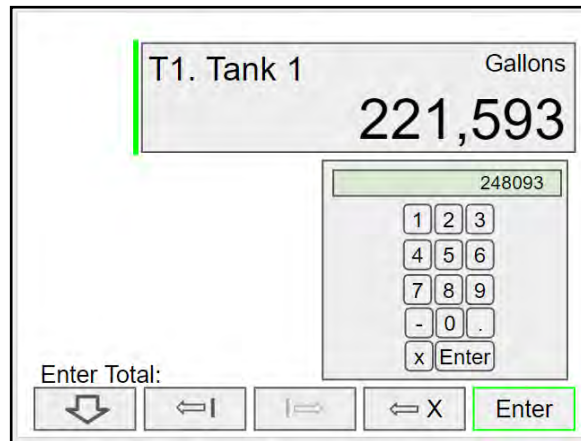

Using the numbers keypad, enter a new total and then press the **Enter** key to save.

Totals Generated by Non-Rate Inputs

For totals generated using non-rate inputs; it is possible to add or remove from the total using the **3-Bar** key on the *View Total* screen.

This type of total requires the use of an external trigger such as a digital input, function key, or a Modbus signal.

For example, if the input to T1 is Ch 1, which is displaying the volume in a container, as provided by the weight being measured by a load cell with a 4-20 mA output, which is the input to channel 1.

- Total 1 = 200,500 gallons
- Channel 1 = 100.0 gallons
- Press function key *Add To (+ T1)*
- 100 gallons is added to Total 1
- New Total 1 = 200,600 gallons

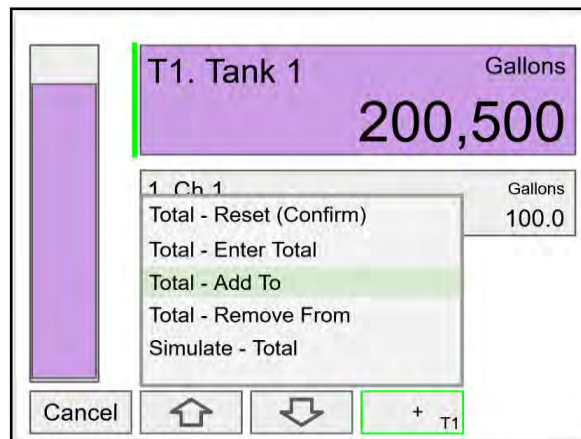

The total in Tank 1 has been incremented by 100 gallons.

The *Remove From* feature can be used to decrement the volume inside a storage tank.

Normally these operations are done automatically by using a proximity switch or a limit switch, connected to a digital input, to trigger the *Add To* or *Remove From* features.

- Digital Input 1
- Function: Add To – T1. Total 1
- Connect a switch between DI-1 and G terminal
- Every time the switch closes, adds 100 gallons to the total 1

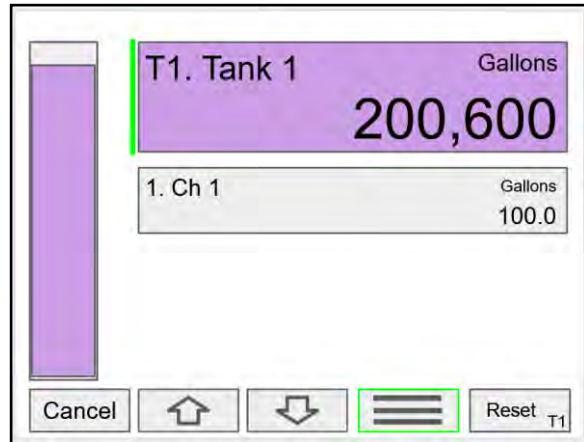

View Timers

The *View Timers* menu displays the value of the existing timers. Press the **Right Arrow** key to step into the details of the selected timer and view the associated inputs and outputs.

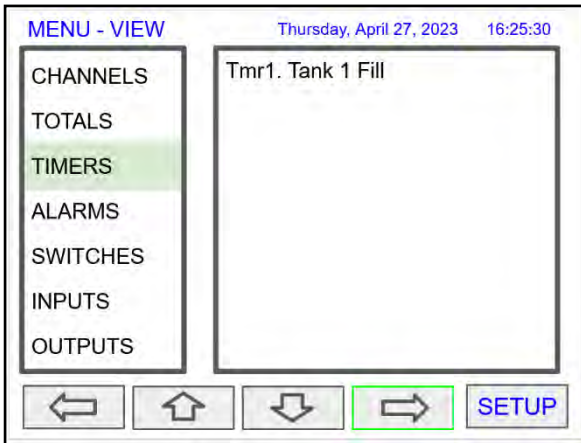

Press the **Right Arrow** key to step into viewing timer.

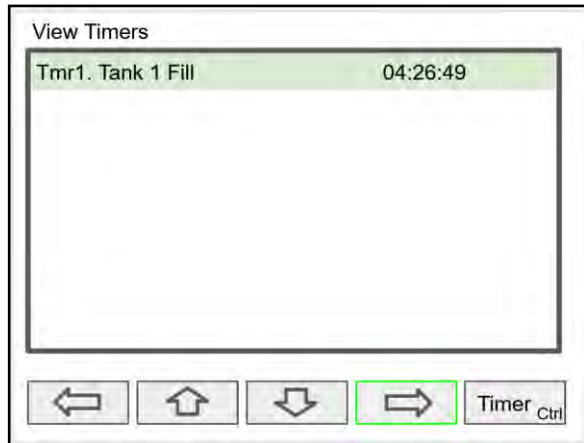

Press the **Right Arrow** key to view timer details.

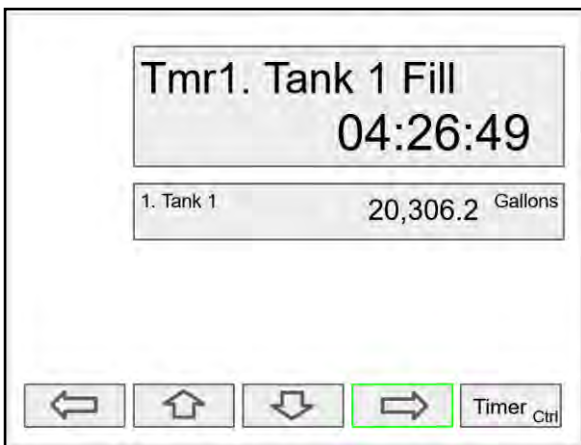

Press the **Right Arrow** key to select timer.

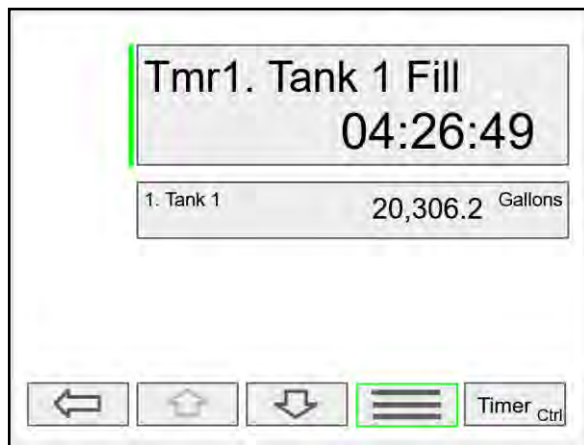

Press the **3-Bar** key to choose Timer Control, Reset, Start, Stop, or Simulate.



Press the **Reset** key to reset the timer, select *Timer Control* for additional functions. Use the *Simulate* function to simulate the timer rising, falling, or jump to a specific value using the keypad.



Press the **TIMER CONTROL** key (shown in the timer details screen) to access all timer control buttons.

View Alarms

The *View Alarms* menu displays the status of all the alarms and the details for each alarm. Under the alarm details view, it is possible to reset an acknowledged alarm, change the set/reset points, or simulate an alarm condition.

- Alarm # and tag
- Set/Reset points
- Source for the alarm
- Outputs associated with the alarm
- Acknowledge the alarm
- Reset the alarm
- Simulate alarm condition

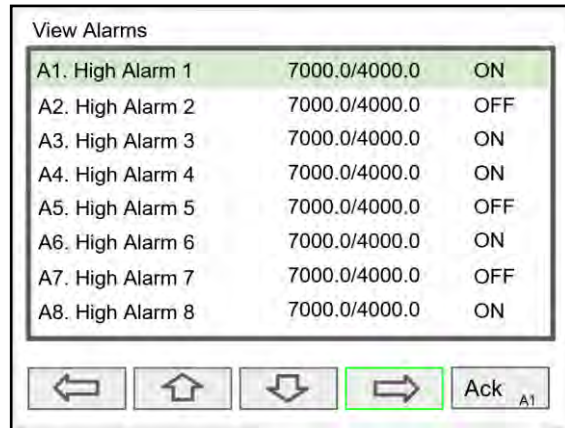

Press the **Right Arrow** key to view the alarm details.

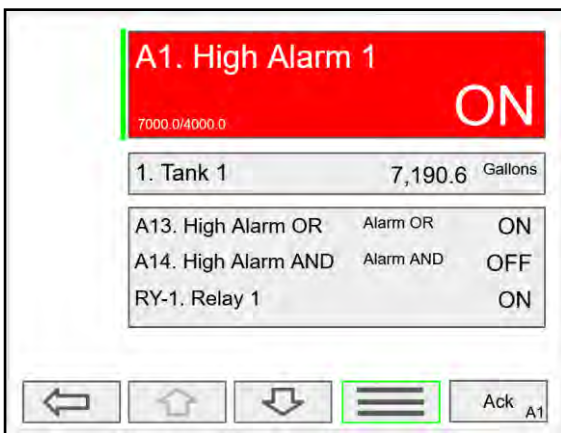

Press the **3-Bar** key to select Ack Alarm, Reset Alarm, change Set Points, or Simulate Alarm condition.

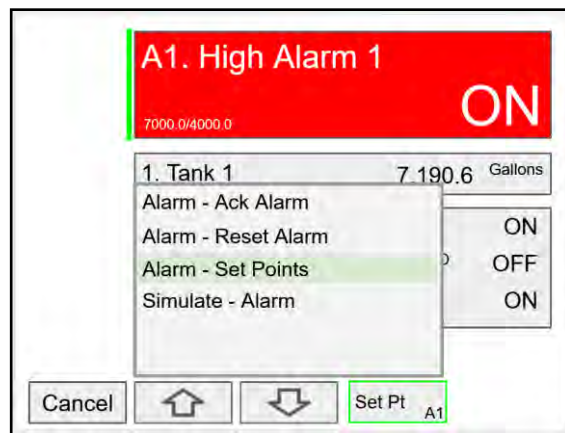

Press the **Set Point** key to change the Set Points. This re-initializes the alarm to reflect the new set point.

Simulate Alarm Condition

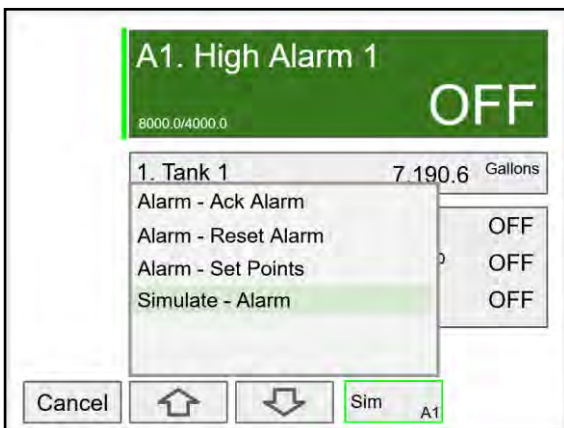

Press the **Simulate** key to simulate an alarm condition.

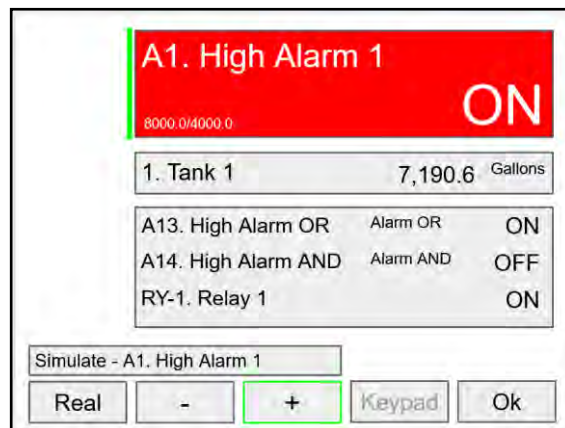

Press the **+** key to turn on the alarm; note that alarm 13 and relay 1 also turned on. Press **Ok** key to maintain simulation or press **Real** to cancel simulation.

View Inputs

The *View Inputs* menu displays the values and status of all the inputs and the details of the associated channels. Input simulation is also available in the input details.

- Input # and tag
- mA input value
- Pulse input frequency
- Digital input status
- Modbus input value
- Temperature input value
- Associated channel(s)
- Input simulation

CAUTION

- Manual control and simulation states are not saved on power cycle. On power up the controller initializes to the actual process conditions.

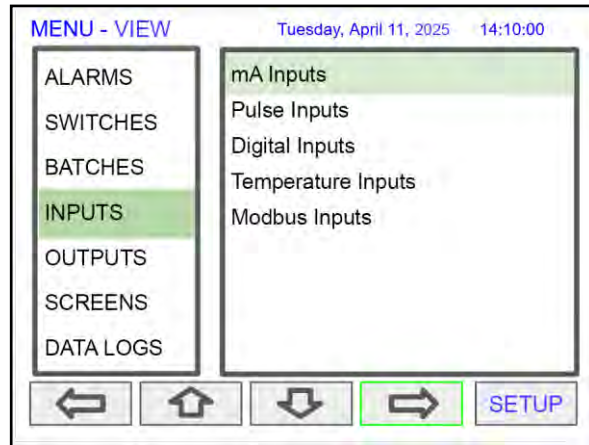

Press **Right Arrow** key to select mA Input.

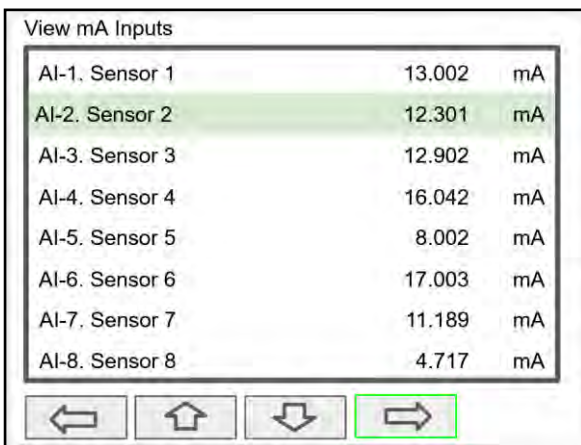

Press the **Right Arrow** key to view the mA Input details.

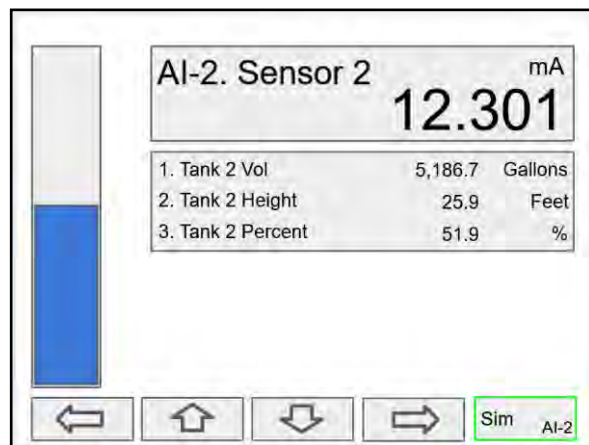

The above screen shows the Analog Input 2 details and the associated channels.

Simulate mA Input

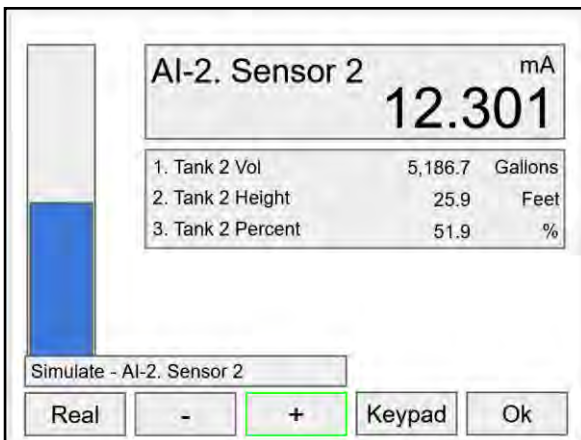

Use the **+ / -** keys to ramp up and down or use the keypad to jump to any value within the range. Press the **Ok** key to maintain the input in simulation mode.

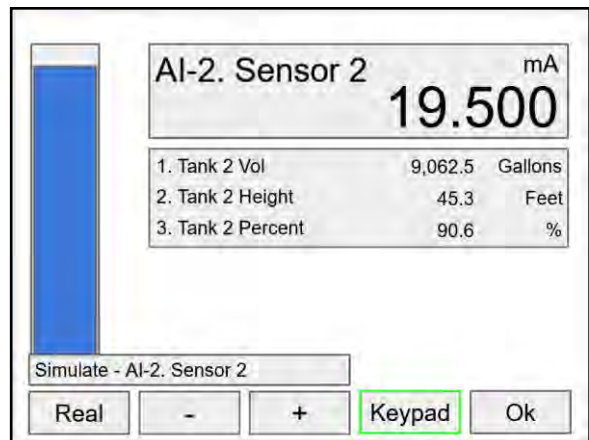

All the parameters associated with the simulated input follow the simulated value. Press the **Real** key to cancel simulation and return to the actual sensor signal.

View Outputs

The *View Outputs* menu displays the values and status of all the outputs and the details of the associated channels.

- Output # and tag
- mA output value
- Relay output status
- Digital output status
- Number of cycles & runtime
- Associated input
- Manual control of relays
- Manual control of 4-20 mA outputs

CAUTION

- Manual control and simulation states are not saved on power cycle. On power up the controller initializes to the actual process conditions.

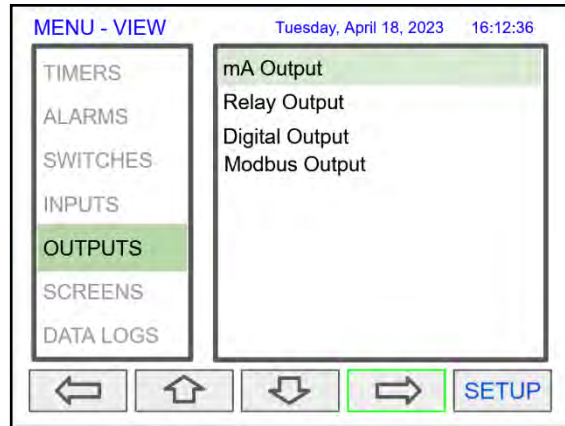

Press the **Right Arrow** key to select the mA Output.

View mA Outputs

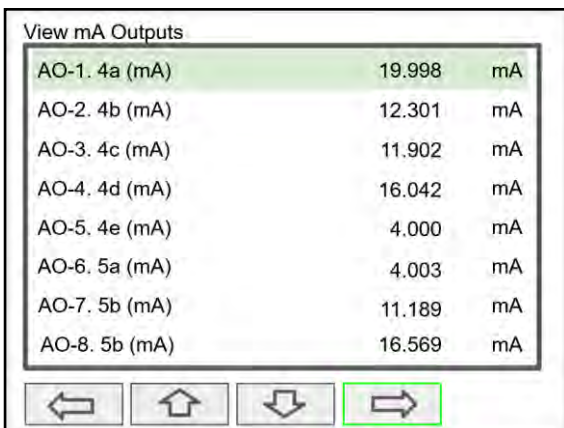

Press the **Right Arrow** key to view the mA Output details.

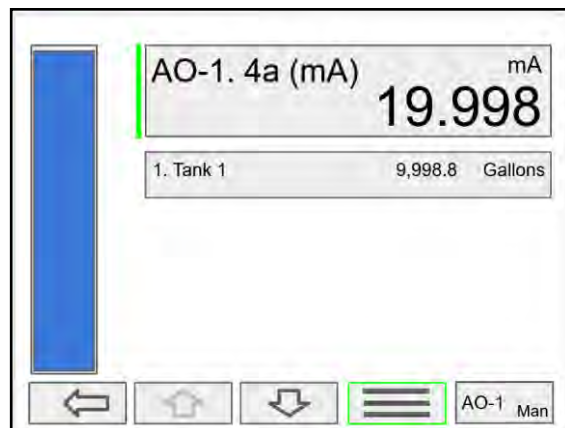

Press the **3-Bar** key to access Analog Output controls. Manual control, hold current value, return to automatic.

Manual Control of 4-20 mA Output

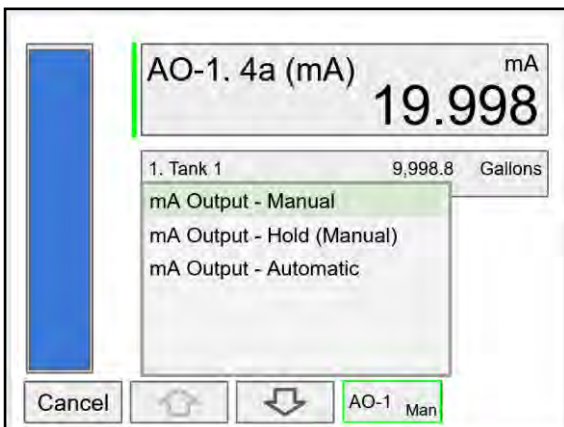

Select **Manual** to control the analog output manually; select **Automatic** to exit manual control.

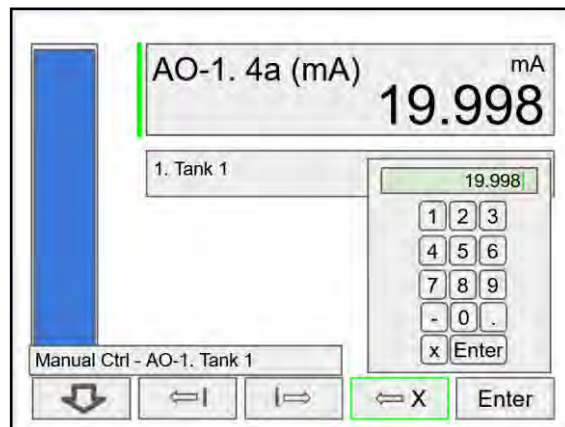

Use the keypad to enter a value for the analog output or use the **+ / -** keys to ramp up and down in small steps.

View Relays

The *View Relays* menu allows the user to view the details for all the relays. The F4 key can be used to turn on and off the selected relay (momentarily). Press the **Right Arrow** key to view the relay details.

- Relay # and tag
- Status
- Runtime
- Number of Cycles
- Reset relay runtime & cycles count
- Parameters associated with the relay
- Other relays used in pump alternation
- Manual control of relays

CAUTION

- Manual control and simulation states are not saved on power cycle.

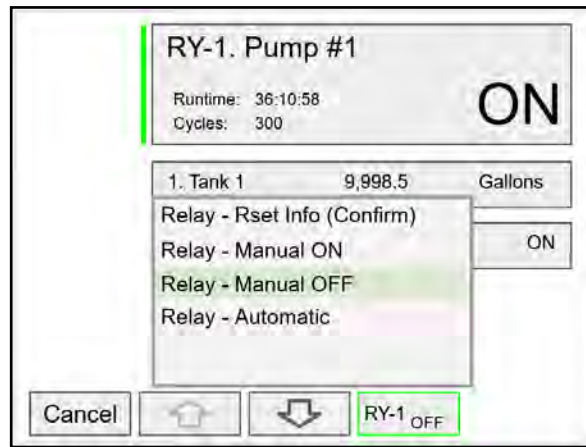
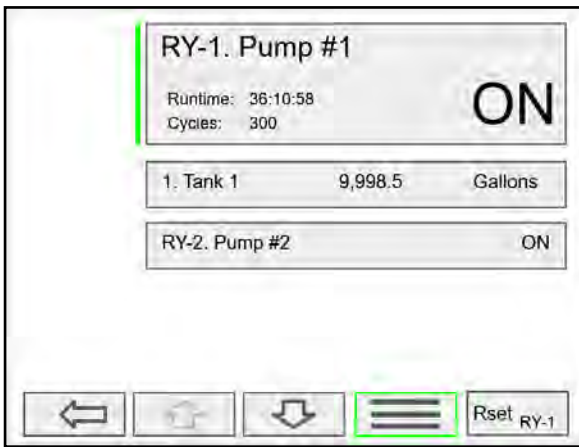
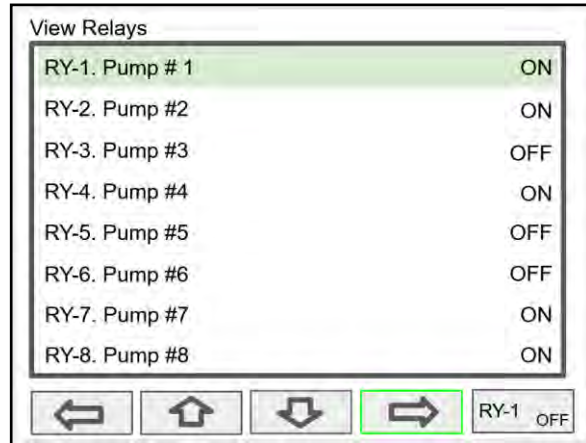

Press the **Manual OFF** to turn off relay 1; Pump #1 will go off and remain off until the relay 1 is put back in automatic mode.

An Alert! message is displayed in place of the Menu key anytime an item is in manual control or simulation mode.

View Alert Messages

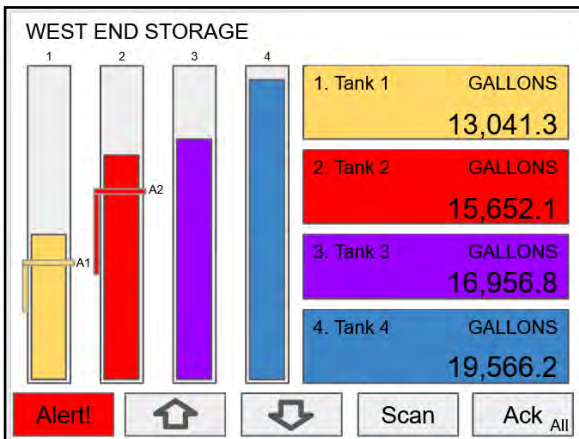

If Alerts are enabled for alarms, the **Menu** key displays a flashing Alert! message on red background. Simulated parameters and manual control outputs, automatically generate alert messages displayed on a yellow background.

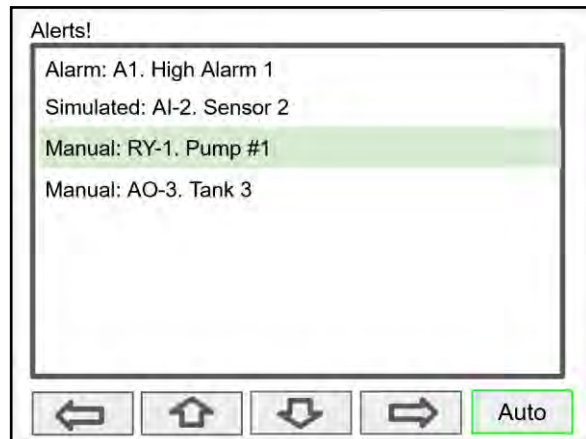

The Alerts! Screen allows the user to acknowledge alarms, return outputs to automatic mode, and navigate to any of the listed items to view the details.

View Digital Outputs

The *View Digital Outputs* screen displays the status of the digital outputs and shows the association with the parameters used to drive the outputs.

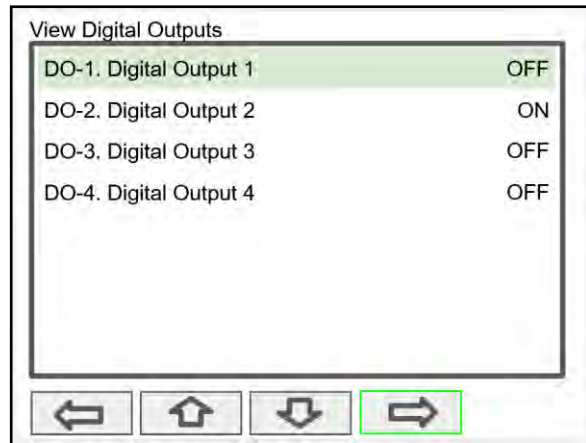

View Modbus Outputs

The *View Modbus Outputs* screen displays the Modbus outputs set up by the user; it shows the register number and the parameter used to generate each output.

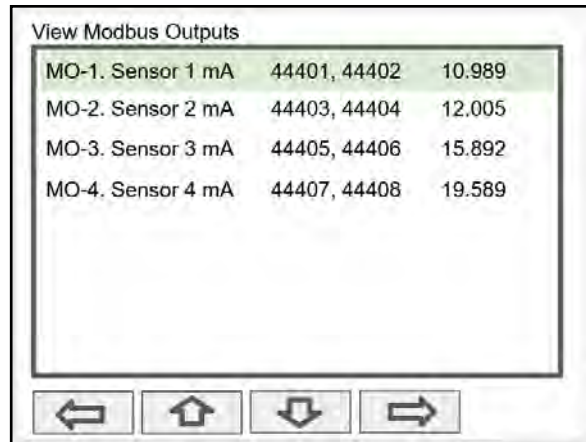

CAUTION

- Manual control and simulation states are not saved on power cycle. On power up the controller initializes to the actual process conditions.

View Screens

With the View Screens menu, the user can go to any available screen and view the details. The screens can be scanned continuously or can be stopped to stay on a selected screen at any time.

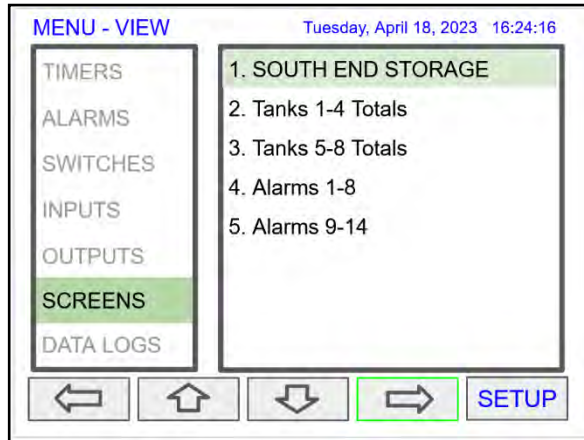

Press the **Right Arrow** key to view details of the selected view screen.

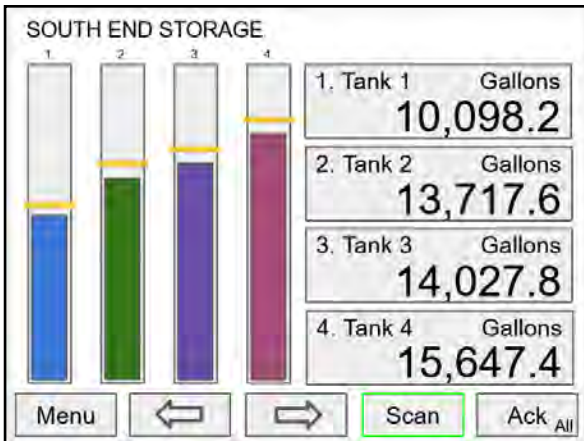

Press the **Scan** key to have all available screens continue to scan.

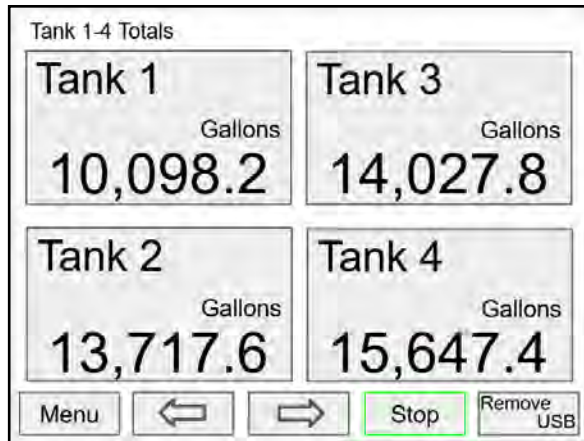

Press the **Stop** key to have all available screens stop scanning and stay on the current screen.

Press the **Remove USB** key to safely remove the USB flash drive.

Operation

Viewing Screens

The controller displays various screens with bargraphs, numerical values, and relay status throughout operation, according to the user-selected setup. There are two basic modes of operation: Automatic scan or manual scan. The controller initializes in automatic scan mode. Press Stop key to stop the automatic scan and use the Left or Right Arrow keys (Previous or Next) to navigate through the various screens. Press the Scan key to resume automatic scanning.

The bargraphs are optional, they are enabled or disabled during Screens setup. The scaling of the bargraph is done during the setup of each channel and it can be different than the channel scaling values.

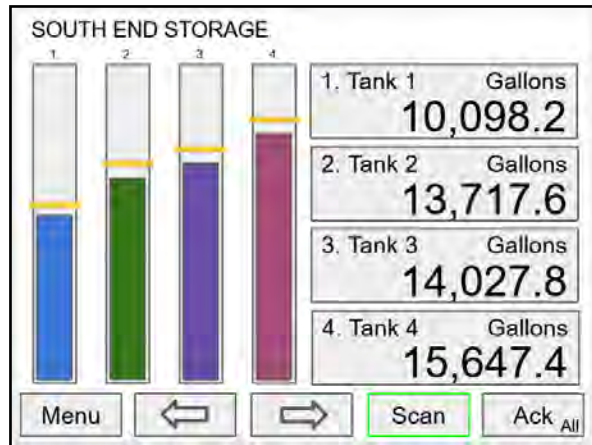

Individual Channel View

To view the details of any channel, press the Menu key and then press Right Arrow key to view the channels. Select the channel of interest. Navigate through the different items using the navigation keys. A green bar indicates the selected item, press the Right Arrow key to step into and see more details about the inputs and outputs related to the channel in view.

If applicable, alarms can be acknowledged, and totals can be reset from these screens. Simulation and manual control are also available on the View screens.

Low & High Alarm Indication

The alarm set points are indicated by a line at the corresponding value on the bargraph. Color selection is done in the Setup – Alarm menu or in the System – Display menu.

Active High Alarm: Indicated by horizontal and vertical lines. The bottom of the vertical line is the reset point of the high alarm. The high alarm is indicated on the left side of the bargraph.

Active Low Alarm: Indicated by horizontal and vertical lines. The top of the vertical line is the reset point of the low alarm. The low alarm is indicated on the right side of the bargraph.

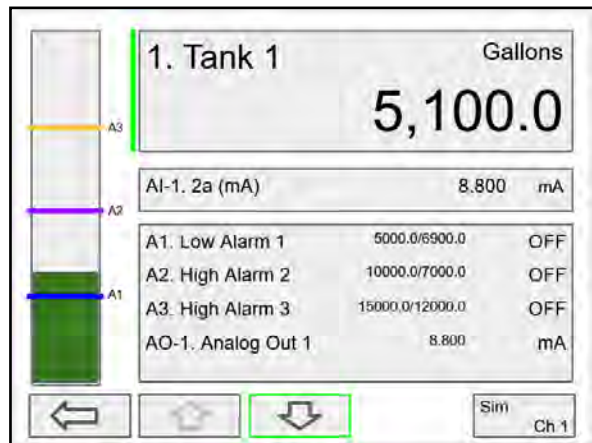

Alarm set points are indicated by horizontal lines.

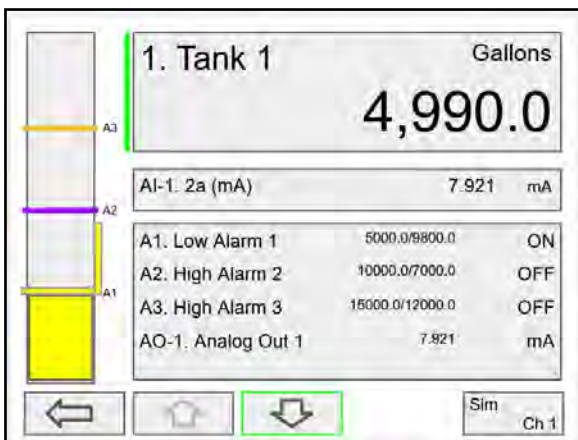

Low alarm indication

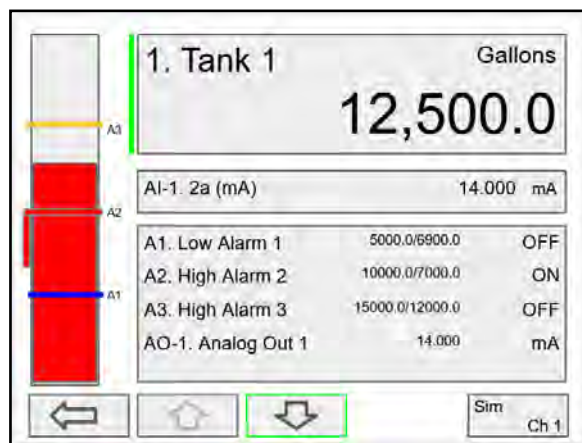

High alarm indication

Multicolor Bargraph Indication

The bargraph can be configured to show different colors depending on the value of the process variable. The following example illustrates the use of colors:

Process Variable %	Bargraph Color	Set Pt	Reset Pt
< 25	Green	N/A	N/A
> 25	Yellow	25.0	25.0
> 50	Amber	50.0	50.0
> 75	Red	75.0	75.0

Note: The bargraph color changes, as shown in the following graphics.

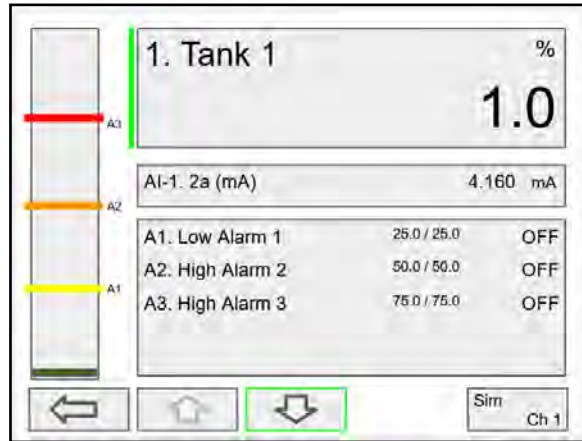

Color changes above the set point for each alarm

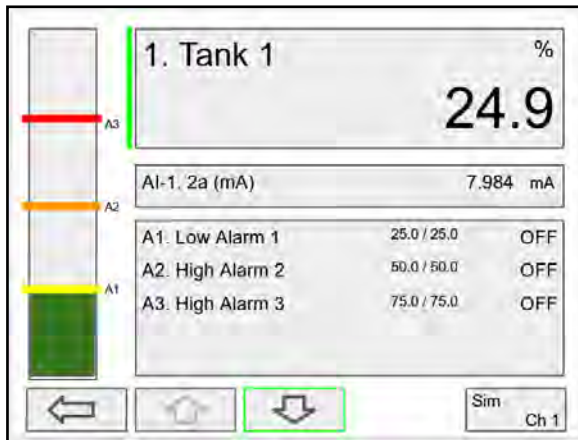

The bargraph shows green below the the first set point

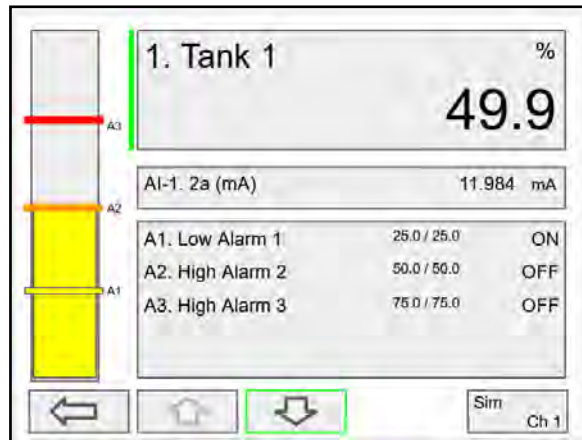

The bargraph changes to yellow above set point 1

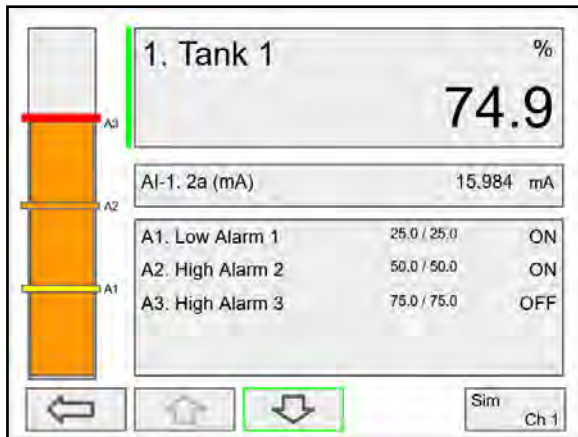

The bargraph changes to orange above set point 2

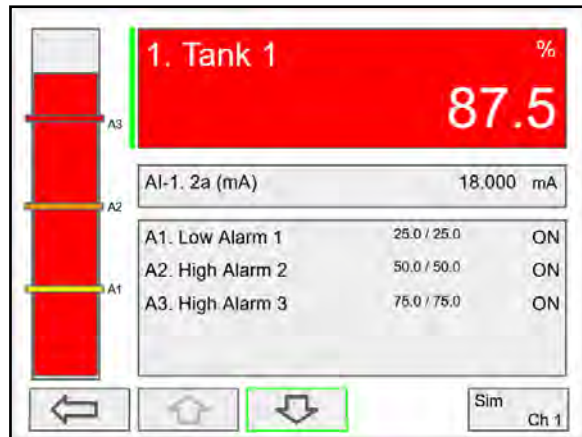

The bargraph changes to red above set point 3. The panel for the value can also be configured to change colors at the specified levels.

Modbus RTU & ASCII Serial Communication

The controller is equipped with serial communication capability as a standard feature. Baud Rate, Parity, Server ID (Address) and Transmit Delay are entered in the *System* menu, which appears in the main *Setup* menu. The baud rate and parity selected must match the settings for all other devices on the network. The Server ID must be unique, so it will not interfere with other devices. Modbus Enron is supported by the Client/Snooper/Spoofers add-on feature.

The controller supports the following Modbus functions:

Command	Name	Description
01	Read Coils (0x)	Read coil value
03	Read Holding Register (4x)	Read multiple bytes from holding registers.
04	Read Input Register (3x)	Read multiple bytes from input registers.
05	Write Single Coil (Bit)	Set single coil value control
15	Write Multiple Coils (Bits)	Set multiple coil value control
06	Write Single Register	Set single value into specified holding register.
16	Write Multiple Registers	Set multiple values into specified holding registers.

The multivariable controller can also work as a "Modbus Display/Controller" by writing the desired value to the selected Modbus input (MB-1 to MB-199). The Modbus input can be used the same way a 4-20 mA input is used; it can be brought into a channel to be displayed and generate alarms to control relays, generate 4-20 mA outputs, and Modbus outputs (MO-1 to MO-64).

Modbus Register Tables

Table 1. Default Register Numbers / Addresses

Reg. Number	Reg. Address	Description	Data Type	Function Codes	R/W
40001	0	Channel (1) Value	Float	03, 04	R
40003	2	Channel (2) Value	Float	03, 04	R
40005	4	Channel (3) Value	Float	03, 04	R
40007	6	Channel (4) Value	Float	03, 04	R
40009	8	Channel (5) Value	Float	03, 04	R
40011	10	Channel (6) Value	Float	03, 04	R
40013	12	Channel (7) Value	Float	03, 04	R
40015	14	Channel (8) Value	Float	03, 04	R
40017	16	Total (1) Value	Float	03, 04	R
40019	18	Total (2) Value	Float	03, 04	R
40021	20	Total (3) Value	Float	03, 04	R
40023	22	Total (4) Value	Float	03, 04	R
40025	24	Timer (1) Value	Float	03, 04	R
40027	26	Timer (2) Value	Float	03, 04	R
40029	28	Timer (3) Value	Float	03, 04	R
40031	30	Timer (4) Value	Float	03, 04	R
40033	32	Alarm (1) Status*	Short	03, 04	R
40034	33	Alarm (2) Status*	Short	03, 04	R
40035	34	Alarm (3) Status*	Short	03, 04	R
40036	35	Alarm (4) Status*	Short	03, 04	R
40037	36	Alarm (5) Status*	Short	03, 04	R
40038	37	Alarm (6) Status*	Short	03, 04	R
40039	38	Alarm (7) Status*	Short	03, 04	R
40040	39	Alarm (8) Status*	Short	03, 04	R

*Alarm Status: 0: Off, 1: On, 2: On & Acknowledged

The table above contains some predefined registers and data types used.

The following table contains the definitions of all accessible registers with their corresponding data type.

Table 2. Device Tag, Date & Time, Firmware Information

Reg. Number	Reg. Address	Description	Data Type	Function Codes	R/W	Comments
40041 - 40056	40-55	Device Tag	String (32 char)	03, 04	R	Null terminating string Write 00 for the last char
		RTC Date & Time				
40061	60	Year	Short	03, 04	R	20 = 2020
40062	61	Month	Short	03, 04	R	
40063	62	Day	Short	03, 04	R	
40064	63	Hour	Short	03, 04	R	
40065	64	Minute	Short	03, 04	R	
40066	65	Second	Short	03, 04	R	
40073	72	SFT No.	Short	03, 04	R	
40074	73	SFT Version	Short	03, 04	R	
40081	80	Program Id	Short	06, 16	W	Program is executed when Program Id is written. Program parameters can be written either before or with the Program Id. See <i>Table 4.</i> for details.
40082 - 40099	81 - 98	Program Parameters (x18)	Various	06, 16	W	

PVs Register Numbers & Addresses

The process variables (PVs) register numbers and register addresses are calculated based on the formulas provided below. The values are available in various data types. Examples of register addresses (base 0) are provided on the right column. Register numbers refer to PLC Addresses (base 1). Function Code 03 Read Holding Registers (4x) are shown on this table and used throughout the system; other functions are also supported as indicated in the Function column.

The Modbus input registers can be configured under the *Setup – Inputs – Modbus Input* menu and the Modbus output registers can be mapped under the *Setup – Outputs – Modbus Output* menu; this allows assigning any parameter to the Modbus output registers and selecting the data type for input and output registers.

The Modbus input and output register numbers are displayed on the controller as they are created; they are listed in this table as reference, if you are away from the controller and need to access the information.

Table 3. PVs Register Numbers & Register Addresses

Reg. Number	Reg. Address	Channel (N = 1 ... 99)	Data Type	Bits	Function	R/W	Reg. Address Examples
00101 + (N - 1)	100 + (N - 1)	Channel (N) Value	Bit	1	01, 02	R	Ch1 = 100
40101 + (N - 1)	100 + (N - 1)	Channel (N) Value	Short	16	03, 04	R	Ch1 = 100
40201 + 2(N - 1)	200 + 2(N - 1)	Channel (N) Value	Long	32	03, 04	R	Ch2 = 202
40401 + 2(N - 1)	400 + 2(N - 1)	Channel (N) Value	Float	32	03, 04	R	Ch3 = 404
40601 + 4(N - 1)	600 + 4(N - 1)	Channel (N) Value	Double	64	03, 04	R	Ch4 = 612
41001 + 4(N - 1)	1000 + 4(N - 1)	Channel (N) Value	Long Long	64	03, 04	R	Ch99 = 1392
		Total (N = 1 ... 32)					
42101 + (N - 1)	2100 + (N - 1)	Total (N) Value	Short	16	03, 04	R	Total 1 = 2100
42201 + 2(N - 1)	2200 + 2(N - 1)	Total (N) Value	Long	32	03, 04	R	Total 1 = 2202
42301 + 2(N - 1)	2300 + 2(N - 1)	Total (N) Value	Float	32	03, 04	R	Total 1 = 2302
42401 + 4(N - 1)	2400 + 4(N - 1)	Total (N) Value	Double	64	03, 04	R	Total 1 = 2404
42601 + 4(N - 1)	2600 + 4(N - 1)	Total (N) Value	Long Long	64	03, 04	R	Total 32 = 2724
		Timer (N = 1 ... 32)					
43101 + (N - 1)	3100 + (N - 1)	Timer (N) Value (sec)	Short	16	03, 04	R	Timer 1 = 3100
43201 + 2(N - 1)	3200 + 2(N - 1)	Timer (N) Value (sec)	Long	32	03, 04	R	Timer 1 = 3202
43301 + 2(N - 1)	3300 + 2(N - 1)	Timer (N) Value (sec)	Float	32	03, 04	R	Timer 1 = 3302
43401 + 4(N - 1)	3400 + 4(N - 1)	Timer (N) Value (sec)	Double	64	03, 04	R	Timer 32 = 3524
		Alarm (N = 1 ... 64)		64			
43601 + (N - 1)	3600 + (N - 1)	Alarm (N) Status	Short		03, 04	R	0: Off, 1: On, 2: On & Ack
		Modbus Output (N = 1 ... 64)					
04101 + (N - 1)	4100 + (N - 1)	Modbus Output (N) Value	Bit (0 or 1)	1	01, 02	R	MO-1 = 4100
44101 + (N - 1)	4100 + (N - 1)	Modbus Output (N) Value	Short	16	03, 04	R	MO-1 = 4100
44201 + 2(N - 1)	4200 + 2(N - 1)	Modbus Output (N) Value	Long	32	03, 04	R	MO-1 = 4202
44401 + 2(N - 1)	4400 + 2(N - 1)	Modbus Output (N) Value	Float	32	03, 04	R	MO-1 = 4402
44601 + 4(N - 1)	4600 + 4(N - 1)	Modbus Output (N) Value	Double	64	03, 04	R	MO-1 = 4604
45001 + 4(N - 1)	5000 + 4(N - 1)	Modbus Output (N) Value	Long Long	64	03, 04	R	MO-64 = 5252
		Modbus Input (N = 1 ... 199)					
06101 + (N - 1)	6100 + (N - 1)	Modbus Input (N) Value	Bit (0 or 1)	1	01, 02, 05, 15	R/W	MB-1 = 6100
46101 + (N - 1)	6100 + (N - 1)	Modbus Input (N) Value	Short	16	03, 04, 06, 16	R/W	MB-1 = 6100
46301 + 2(N - 1)	6300 + 2(N - 1)	Modbus Input (N) Value	Long	32	03, 04, 16	R/W	MB-1 = 6302
46701 + 2(N - 1)	6700 + 2(N - 1)	Modbus Input (N) Value	Float	32	03, 04, 16	R/W	MB-1 = 6702
47101 + 4(N - 1)	7100 + 4(N - 1)	Modbus Input (N) Value	Double	64	03, 04, 16	R/W	MB-1 = 7104
47901 + 4(N - 1)	7900 + 4(N - 1)	Modbus Input (N) Value	Long Long	64	03, 04, 16	R/W	MB-199 = 8692

Modbus Write Protection

The Modbus write passcode protection can be enabled in the *System – Modbus* menu. This protection prevents writing to the registers, unless the unlock code 1 is sent to register 81 followed by the passcode sent to register 82. The protection is automatically restored after 30 seconds of Modbus – write inactivity. See page 142 for details.

Table 4. Program Parameters for Special Functions

Reg. Number	Reg. Address	Description	Data Type	Function	R/W	Program Code	Comments
40081	80	Program Id					Program is executed when Program Id is written.
40082 - 40099	81 - 98	Program Parameters (x8)					Program parameters can be written either before or with the Program Code.
40081	80	Unlock Modbus Passcode	Short	06, 16	W	1	Locks again after 30 seconds.
40082	81	Modbus Passcode	Short	06, 16	W		Cleared upon execution. Must be re-written with each Unlock.
40081	80	Set RTC Date & Time	Short	06, 16	W	6	
40082	81	Year	Short	06, 16	W		0..99
40083	82	Month	Short	06, 16	W		1..12
40084	83	Day	Short	06, 16	W		1..31
40085	84	Hour	Short	06, 16	W		0..23 Program Code plus parameters ending at Hour will set Minute and Second to zero.
40086	85	Minute	Short	06, 16	W		0..59 Program Code plus parameters ending at Minute will set Second to zero
40087	86	Second	Short	06, 16	W		0..59
40081	80	Channel - Get Tag	Short	06, 16	W	11	
40082	81	Channel (N)	Short	06, 16	W		
40083 - 40090	82 - 89	Tag	String (16 char)	03, 04	R		Null terminated string.
40081	80	Reset Channel	Short	06, 16	W	12	
40082	81	Channel (N)	Short	06, 16	W		Program Code with only single parameter will ignore remaining parameters.
40083	82	Thru Channel (N)	Short	06, 16	W		0 to ignore
40081	80	Set Channel	Short	06, 16	W	13	Tare, Capture, Switch
40082	81	Channel (N)	Short	06, 16	W		Program Code with only single parameter will ignore remaining parameters.
40083	82	Thru Channel (N)	Short	06, 16	W		0 to ignore
40081	80	Total - Get Tag	Short	06, 16	W	27	
40082	81	Total (N)	Short	06, 16	W		
40083 - 40090	82 - 89	Tag	String (16 char)	03, 04	R		Null terminated string.

Reg. Number	Reg. Address	Description	Data Type	Function	R/W	Program Code	Comments
40081	80	Reset Total	Short	06, 16	W	28	
40082	81	Total (N)	Short	06, 16	W		Program Code with only single parameter will ignore remaining parameters.
40083	82	Thru Total (N)	Short	06, 16	W		0 to ignore
40081	80	Timer - Get Tag	Short	06, 16	W	41	
40082	81	Timer (N)	Short	06, 16	W		
40083 - 40090	82 - 89	Tag	String (16 char)	03, 04	R		Null terminated string.
40081	80	Timer	Short	06, 16	W	42	
40082	81	Timer (N) - Reset	Short	06, 16	W		0 to not Reset Program Code with parameters will ignore remaining parameters. Program Code with single Timer (N) will Reset without Start or Stop.
40083	82	Timer (N) - Start	Short	06, 16	W		0 to not Start Program Code with two Timer (N) registers will Reset and Start; and ignore Stop.
40084	83	Timer (N) - Stop	Short	06, 16	W		0 to not Stop
40085	84	Thru Timer (N) - Reset	Short	06, 16	W		0 to ignore
40086	85	Thru Timer (N) - Start	Short	06, 16	W		0 to ignore
40087	86	Thru Timer (N) - Stop	Short	06, 16	W		0 to ignore
40081	80	Alarm - Get Tag	Short	06, 16	W	55	
40082	81	Alarm (N)	Short	06, 16	W		
40083 - 40090	82 - 89	Tag	String (16 char)	03, 04	R		Null terminated string.
40081	80	Reset Alarm	Short	06, 16	W	56	
40082	81	Alarm (N)	Short	06, 16	W		Program Code with only single parameter will ignore remaining parameters.
40083	82	Thru Alarm (N)	Short	06, 16	W		0 to ignore
40081	80	Ack Alarm	Short	06, 16	W	57	
40082	81	Alarm (N)	Short	06, 16	W		Program Code with only single parameter will ignore remaining parameters.
40083	82	Thru Alarm (N)	Short	06, 16	W		0 to ignore
40081	80	Alarm - Start	Short	06, 16	W	58	Interval alarms
40082	81	Alarm (N)	Short	06, 16	W		Program Code with only single parameter will ignore remaining parameters.
40083	82	Thru Alarm (N)	Short	06, 16	W		0 to ignore
40081	80	Alarm - Stop	Short	06, 16	W	59	Interval alarms

Reg. Number	Reg. Address	Description	Data Type	Function	R/W	Program Code	Comments
40082	81	Alarm (N)	Short	06, 16	W		Program Code with only single parameter will ignore remaining parameters.
40083	82	Thru Alarm (N)	Short	06, 16	W		0 to ignore
40081	80	Alarm - Restart	Short	06, 16	W	60	Interval alarms
40082	81	Alarm (N)	Short	06, 16	W		Program Code with only single parameter will ignore remaining parameters.
40083	82	Thru Alarm (N)	Short	06, 16	W		0 to ignore
40081	80	Horn - Silence	Short	06, 16	W	73	Horn Off until new trigger.
40081	80	Horn - Snooze	Short	06, 16	W	74	Horn Off until new trigger, or until Seconds.
40082	81	Seconds	Short	06, 16	W		
40081	80	Horn - Test	Short	06, 16	W	75	Horn Off until Seconds.
40082	81	Seconds	Short	06, 16	W		
40081	80	Relay - Get Tag	Short	06, 16	W	82	
40082	81	Relay (N)	Short	06, 16	W		
40083 - 40090	82 - 89	Tag	String (16 char)	03, 04	R		Null terminated string.
40081	80	Relay - Reset Info	Short	06, 16	W	83	
40082	81	Relay (N)	Short	06, 16	W		Program Code with only single parameter will ignore remaining parameters.
40083	82	Thru Relay (N)	Short	06, 16	W		0 to ignore
40081	80	Relay - Automatic	Short	06, 16	W	84	
40082	81	Relay (N)	Short	06, 16	W		Program Code with only single parameter will ignore remaining parameters.
40083	82	Thru Relay (N)	Short	06, 16	W		0 to ignore
40081	80	Relay - Manual ON	Short	06, 16	W	85	
40082	81	Relay (N)	Short	06, 16	W		Program Code with only single parameter will ignore remaining parameters.
40083	82	Thru Relay (N)	Short	06, 16	W		0 to ignore
40081	80	Relay - Manual OFF	Short	06, 16	W	86	
40082	81	Relay (N)	Short	06, 16	W		Program Code with only single parameter will ignore remaining parameters.
40083	82	Thru Relay (N)	Short	06, 16	W		0 to ignore

Reg. Number	Reg. Address	Description	Data Type	Function	R/W	Program Code	Comments
40081	80	Relay - Manual Hold	Short	06, 16	W	87	
40082	81	Relay (N)	Short	06, 16	W		Program Code with only single parameter will ignore remaining parameters.
40083	82	Thru Relay (N)	Short	06, 16	W		0 to ignore
40081	80	mA Out - Get Tag	Short	06, 16	W	92	
40082	81	mA Out (N)	Short	06, 16	W		
40083 - 40090	82 - 89	Tag	String (16 char)	03, 04	R		Null terminated string.
40081	80	mA Out - Automatic	Short	06, 16	W	93	
40082	81	mA Out (N)	Short	06, 16	W		Program Code with only single parameter will ignore remaining parameters.
40083	82	Thru mA Out (N)	Short	06, 16	W		0 to ignore
40081	80	mA Out - Manual	Short	06, 16	W	94	
40082	81	mA Out (N)	Short	06, 16	W		
40083 - 40084		value (N)	float	06, 16	W		
40081	80	mA Out - Manual	Short	06, 16	W	95	
40082	81	mA Out (N)	Short	06, 16	W		
40083	82	value x 100 (N)	Short	06, 16	W		For 4.00 mA, write 400. For 16.5 mA, write 1650.
40081	80	mA Out - Manual Hold	Short	06, 16	W	96	
40082	81	mA Out (N)	Short	06, 16	W		Program Code with only single parameter will ignore remaining parameters.
40083	82	Thru mA Out (N)	Short	06, 16	W		0 to ignore
40081		Batch - Get Tag	Short	06, 16	W	45	
40082	81	Batch (N)	Short	06, 16	W		
40083 - 40090	82 - 89	Tag	String (16 char)	03, 04	R		Null terminated string.
40081	80	Batch - Start	Short	06, 16	W	46	
40082	81	Batch (N)	Short	06, 16	W		Program Code with only single parameter will ignore remaining parameters.
40083	82	Thru Batch (N)	Short	06, 16	W		0 to ignore
40081	80	Batch - Start Partial	Short	06, 16	W	47	
40082	81	Batch (N)	Short	06, 16	W		Program Code with only single parameter will ignore remaining parameters.
40083 - 40084	82-83	value	float	16	W		
40083 - 40086	82-85	value	double	16	W		Not available with Enron addressing.

Reg. Number	Reg. Address	Description	Data Type	Function	R/W	Program Code	Comments
40081	80	Batch - Stop	Short	06, 16	W	48	
40082	81	Batch (N)	Short	06, 16	W		Program Code with only single parameter will ignore remaining parameters.
40083	82	Thru Batch (N)	Short	06, 16	W		0 to ignore
40081	80	Alarm - Set Setpts	Short	06, 16	W	61	
40082	81	Alarm (N)	Short	06, 16	W		Program Code with only single parameter will ignore remaining parameters.
40083 - 40084	82-83	set point	float	16	W		
40085 - 40086	84-85	reset point	float	16	W		

Modbus Applications

Snooper Mode

The *Snooper* mode can listen and read the process variables being transmitted on the RS-485 bus without causing any disruptions to the network. The controller can read up to 199 Modbus values, as inputs from other Modbus devices are being polled by a Modbus Client. The inputs can be used as the source for channels, math functions, alarms, relay control, etc.

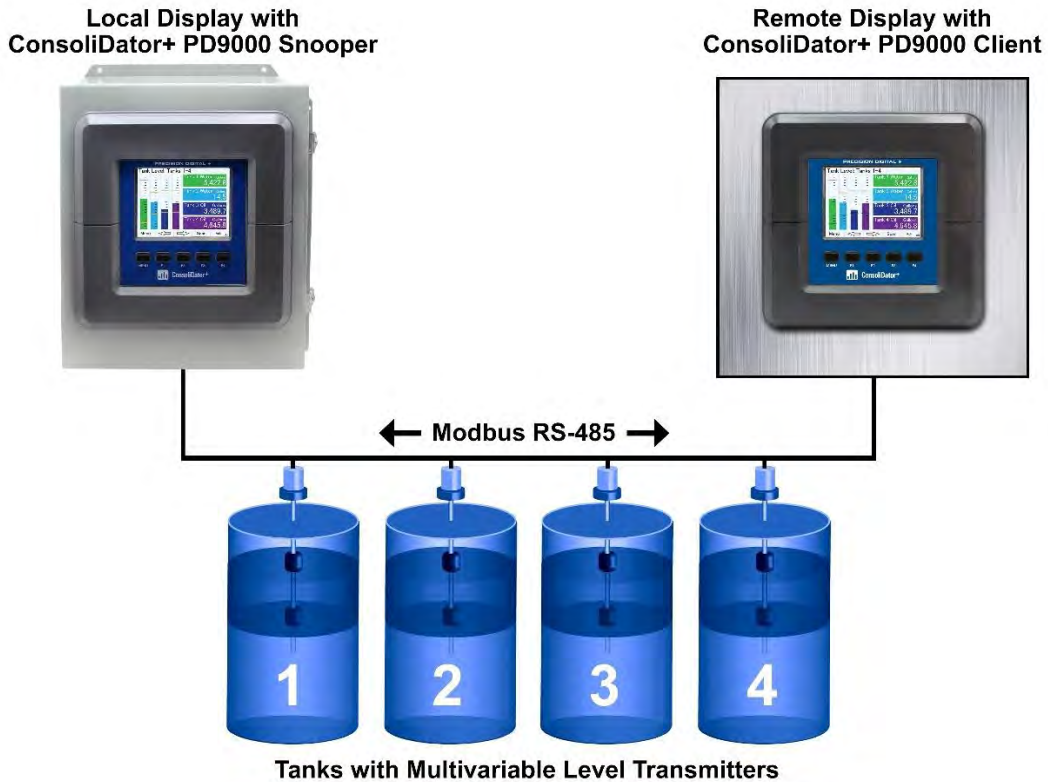

Relay Control Using Modbus

To control the relays via Modbus, use the Write Single Coil command [command code 05] or Write Multiple Coils [command code 15] and send either the “ON” or “OFF” to the Modbus input associated with the target relay.

Setup Example #1

Follow this example to set up Modbus Input to control a relay and configure the system to display messages related to the status of the device being controlled, in this case a pump.

Setup – MB-1.

1. Tag: Modbus Input 1
2. Type: Bit – Logic (Reg. No. 06101 or Reg. Address 06100)
3. Units: Logic = PUMP ON / PUMP OFF
4. Break: Default = PUMP OFF

Setup – RY-1.

1. Tag: Relay 1
2. Input: MB-1. Modbus Input 1

Setup – Create Screen

1. Title: Pumps
2. MB-1. Modbus Input 1
3. RY-1. Relay 1
4. F3: Assign to Force On RY-1
5. F4: Assign to Force Off RY-1

Operation: Write “1” to Reg. 06101 to turn relay 1 On; write “0” to turn relay 1 Off.

Setup Example #2

Follow this example to control the relays directly from Modbus using special program functions. You can control one or any number of relays with one command.

40081	80	Relay - Automatic	Short	06, 16	W	84	
40082	81	Relay (N)	Short	06, 16	W		Program Code with only single parameter will ignore remaining parameters.
40083	82	Thru Relay (N)	Short	06, 16	W		0 to ignore
40081	80	Relay - Manual ON	Short	06, 16	W	85	
40082	81	Relay (N)	Short	06, 16	W		Program Code with only single parameter will ignore remaining parameters.
40083	82	Thru Relay (N)	Short	06, 16	W		0 to ignore
40081	80	Relay - Manual OFF	Short	06, 16	W	86	
40082	81	Relay (N)	Short	06, 16	W		Program Code with only single parameter will ignore remaining parameters.
40083	82	Thru Relay (N)	Short	06, 16	W		0 to ignore

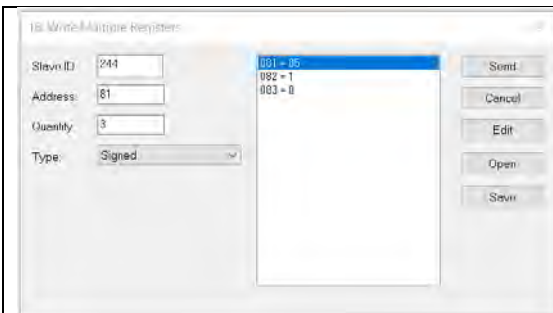

- 1) To manually turn on relay 1 write:
 - a. Reg. 40081: 85
 - b. Reg. 40082: 1
 - c. Reg. 40083: 0 (last relay, if more than one)
- 2) To manually turn off relay 1 write:
 - a. Reg. 40081: 86
 - b. Reg. 40082: 1
 - c. Reg. 40083: 0 (last relay, if more than one)
- 3) To return relays to normal operation write commands for automatic control.
 - a. Reg. 40081: 84

Troubleshooting Tips

This controller is a highly sophisticated instrument with an extensive list of features and capabilities. If the front panel buttons are used to program the controller, it may be a difficult task to keep everything straight. That is why we strongly recommend the use of the free ConsoliDator+ configuration software for all programming activities. A cable is provided with the controller for programming with the software. If you have programmed the controller with the front panel buttons and it is not working as intended, try re-programming it with the ConsoliDator+ configuration software.

Symptom	Check/Action
No display or only backlight is visible, but outputs still function normally.	<ol style="list-style-type: none"> 1. Ambient temperature is below -40°C and affects LCD visibility. 2. Grounding is inadequate or not connected. Check earth ground continuity.
“BREAK” is displayed	<ol style="list-style-type: none"> 1. Check the 4-20 mA input; if less than the break value (e.g. 0.01 mA), it displays BREAK. This can be changed in the Input menu. 2. Modbus: Make sure all devices in the network have a unique server ID. 3. Modbus Inputs: Check the Timeout setting, increase the timeout if necessary. 4. Temperature Inputs: Check <i>Temperature Input Connections</i> on page 36. Make sure the correct input type is selected.
Display response seems slower than normal	Ambient temperature is too cold: Consider installing a heater with the instrument.
Display reading is unstable, it fluctuates too much	<ol style="list-style-type: none"> 1. Check signal source stability 2. Increase filter value 3. Decrease the display refresh rate (increase time)
mA input not responding to signal changes (value seems to be frozen)	<ol style="list-style-type: none"> 1. Cycle the power or 2. Go to setup mA input and disable input channel, then enable the input channel 3. Check that back cover is fully seated, and all I/O cards are tightly fixed in place.
Display locks up or the instrument does not respond at all	Cycle the power to reboot the microprocessor.
Settings reprogrammed, but instrument behavior remains as previously programmed	Cycle the power to reboot the microprocessor.
Relay and status do not respond to signal	<ol style="list-style-type: none"> 1. Check if relays are in manual control mode. 2. Check Setup menu alarm set and reset points.
Writing to Modbus Input register failed	<p>Check register number or register address being used</p> <ol style="list-style-type: none"> 1. If using PLC address (Base 1) use register number (e.g. 46701) 2. If using Base 0 address, use register address (e.g. 6700)
The Modbus value being read is not correct	<ol style="list-style-type: none"> 1. Check the data type. 2. Check the byte order. 3. Confirm the units being sent by the server
Controller does not communicate with another device.	Check baud rates and parity settings. Make sure all serial devices have matching parameters.
Functions keys are not responding	<ol style="list-style-type: none"> 1. Check the digital inputs assignment, if they are assigned to be used as remote buttons, make sure they are set up as “Active Low” and check that no digital input is activated. 2. Go to <i>Setup – Screens</i> and check the assignment of F1-F4, this can be affected if an incompatible configuration has been written.
Modbus Client/Snooper/Spoofers settings are not available	<ol style="list-style-type: none"> 1. Confirm that the Add-On feature has been enabled. Go to <i>System → General</i>, the Modbus Client/Snooper/Spoofers should be listed. 2. Go to <i>System → Modbus</i> and select the <i>Client, Snooper, or Spoofer</i> mode.
Data Logger stopped working	<ol style="list-style-type: none"> 1. If Start / Stop is enabled and a power cycle occurred, that would have caused the data logger to stop; re-start the log. 2. Check <i>System → USB Drive</i> and confirm the USB drive is found. 3. If “Stop when Full” is checked, the flash drive might be full. Remove the flash drive and connect to a PC to download the files.
There is too much overshoot	<ol style="list-style-type: none"> 1. Increase the Proportional band (Pb) 2. Increase the Derivative (D) setting
The process is too slow to reach the target	<ol style="list-style-type: none"> 1. Decrease the Proportional band (Pb) 2. Increase the Integral (I) setting
Alert! message displayed on Menu key	Alarms active, Simulation mode being used, or USB drive not installed.
Other symptoms not described above	Call Technical Support for assistance.

Model:	
Serial Number:	
System Password:	

Contact Precision Digital

Technical Support

Call: (800) 610-5239 or (508) 655-7300

Email: support@predig.com

Sales Support

Call: (800) 343-1001 or (508) 655-7300

Email: sales@predig.com

Place Orders

Email: orders@predig.com

For the latest version of this manual please visit

www.predig.com

PRECISION DIGITAL CORPORATION

233 South Street • Hopkinton MA 01748 USA

Tel (800) 343-1001 • (508) 655-7300

www.predig.com

