

JUXTA *VJ* series



VJ for use with Yokogawa's High Performance Transmitters!

Pressure Transmitter



2-WIRE TRANSMISSION

Vortex Flow Meter



PULSE SIGNAL TRANSMISSION

Magnetic Flow Meter



SIGNAL ISOLATION

pH Transmitter



Temperature Transmitter



TC RTD Temperature Sensor



Visit our web site
<http://www.yokogawa.com>

Everything you want in a signal conditioner Reliability, Quality and Stability.

Compact

Easy plug-in installation

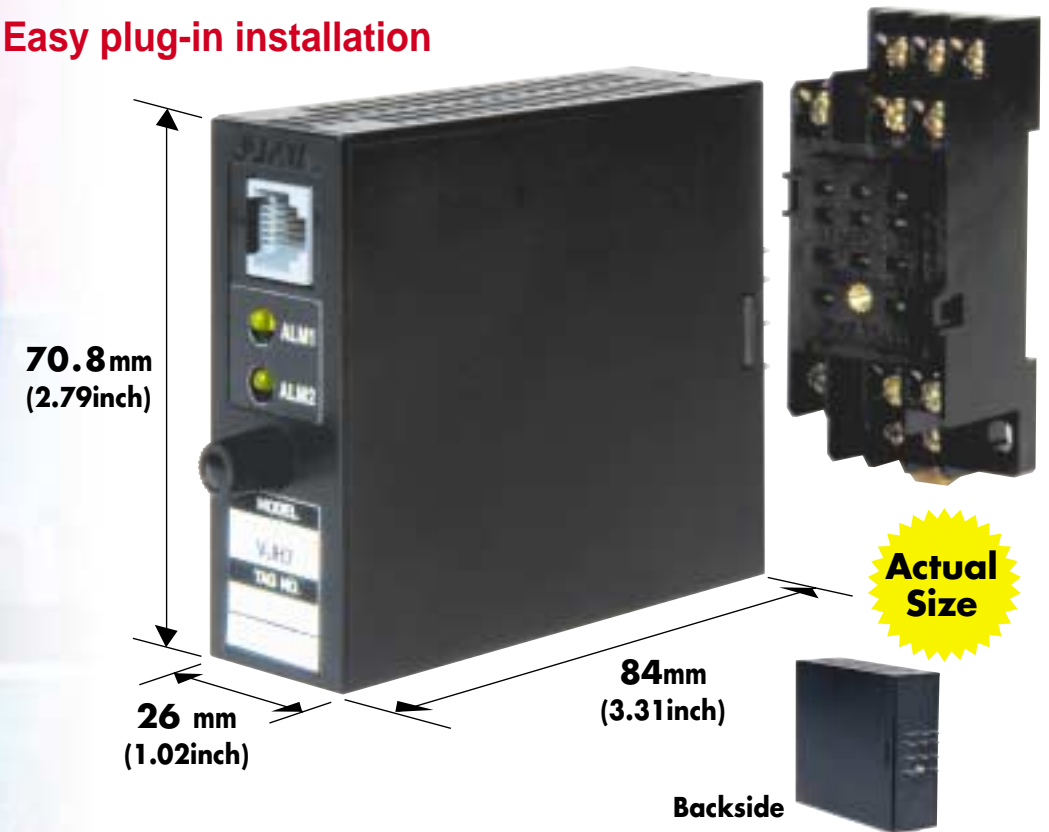

High Quality

- High Accuracy ±0.1%**
Basic accuracy is ±0.1% of span
- Two Isolated Outputs**
Optional 2nd analog output for output-2
- Four-way Isolation**
Input, output-1, output-2 and power supply are isolated from each other.
- Built-in Alarm Outputs**
Optional two relay alarm contact outputs for output-2
- Universal Input**
Field configurable input type (mV/thermocouple, RTD) and range (VJU7)
- MODBUS Communication**
Optional RS485 communication port for output-2

Field Configurable Capability

Input type and range can be changed at customer's site

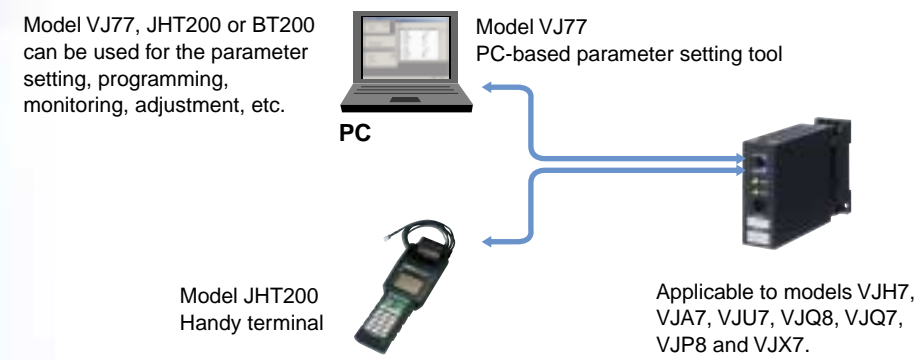

(Model BT200 of Yokogawa Electric Corporation can also be used for parameter setting. A communication cable (parts no.F9182EE) and a modular-jack adapter (parts no.E9786WH) shall be used with BT200.)

Multi Function

Two Isolated Analog Outputs

Protect your system from ground loops

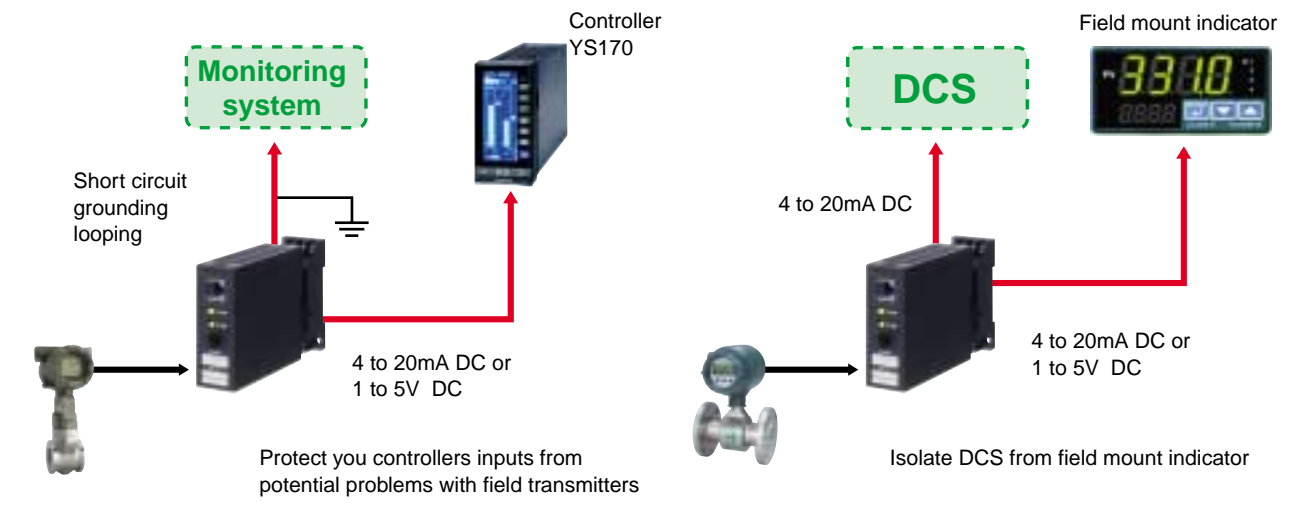

Built-in Alarm Outputs

Replace an old analog signal conditioner and alarm module with one JUXTA VJ

VJ series signal conditioner has both an analog output and optional two alarm relay outputs. Each alarm relay output can be used as high limit, low limit or deviation alarm. Alarm conditions can be monitored by two alarm lamps on the front panel. Alarm set points are set by using configuration tools, model VJ77, JHT200 or BT200.

[Monitor the tank level by VJA7]

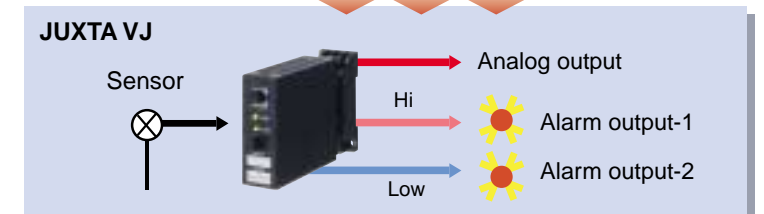
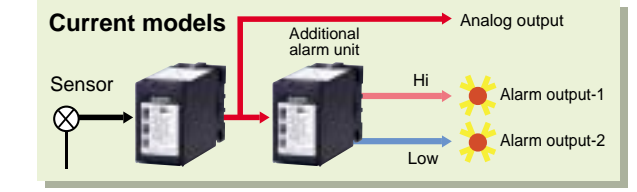
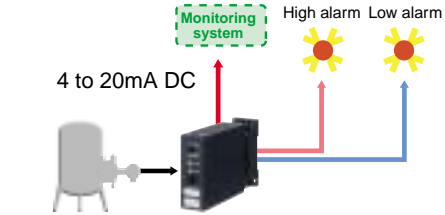

Applicable to models VJH7, VJA7, VJU7, VJS7, VJQ8 and VJQ7

MODBUS Communication Function

Communication output

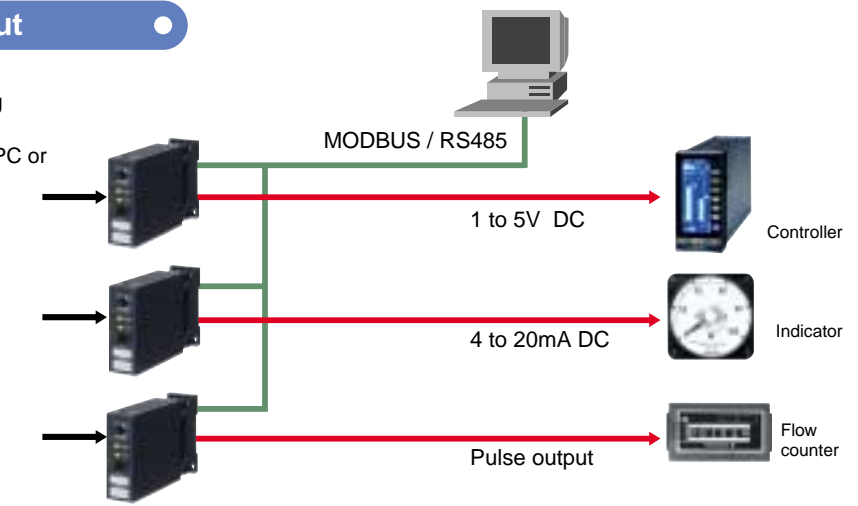

VJ series signal conditioner has both an analog output and a RS485 communication port. Input signal and alarm status can be sent to a PC or PLC via communications.

Protocol: MODBUS, PC-link or Ladder
Communication rate: Up to 9600bps
Connectable signal conditioners: Up to 31





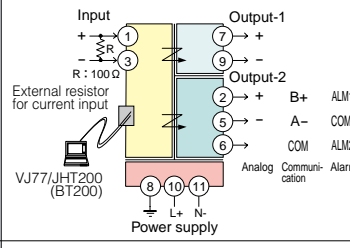
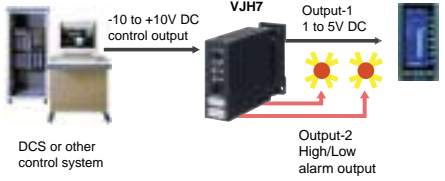

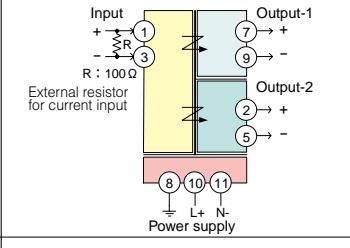
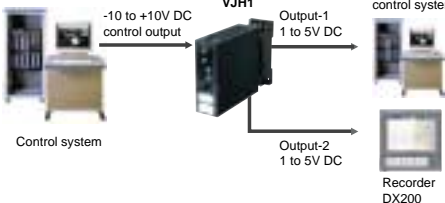
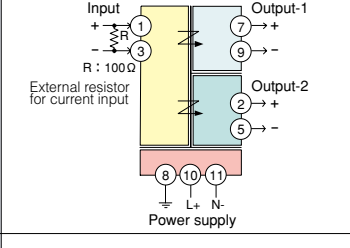
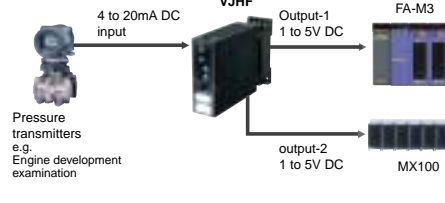
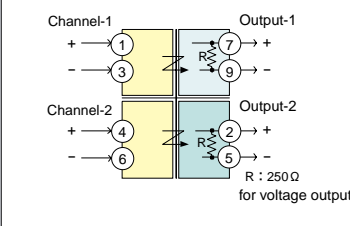
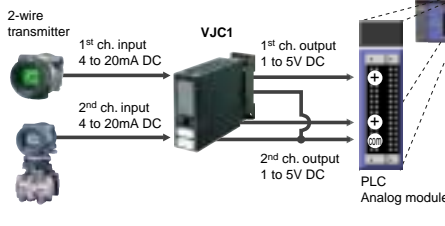
Applicable to models VJH7, VJA7, VJU7, VJS7, VJQ8, VJQ7, VJP8 and VJX7

Isolators

Model	Key words	Block diagram	Input	Output-1			Output-2				Application
				1to5V DC	4to20mA DC	Other analog signal	1to5V DC	4to20mA DC	Alarm	Communi-cation	
VJH7 Isolator Multifunction 	<ul style="list-style-type: none"> High accuracy 0.1% of span 3 year warranty Field configurable 		Field configurable: 0 to 50mA DC (min. span: 5mA) or -10 to +10V DC (min. span: 0.1V)	YES	YES	YES	YES	YES	YES	YES	
VJH1 Isolator 	<ul style="list-style-type: none"> High accuracy 0.1% of span 		4 to 20mA, 2 to 10mA, 1 to 5mA, 0 to 20mA, 0 to 16mA, 0 to 10mA, 0 to 1mA, 10 to 50mA, 0 to 10mV, 0 to 100mV, 0 to 1V, 0 to 10V, 0 to 5V, -10 to +10V DC < specify when ordering >	YES	YES	YES	YES	YES	-	-	
VJHF Isolator Super Speed Response	<ul style="list-style-type: none"> 50µs signal conversion for 63% response High accuracy 0.1% of span 		4 to 20mA, 2 to 10mA, 1 to 5mA, 0 to 20mA, 0 to 16mA, 0 to 10mA, 0 to 1mA, 10 to 50mA, 0 to 1V, 0 to 10V, 0 to 5V, 1 to 5V, -10 to +10V DC < specify when ordering >	YES	YES	YES	YES	YES	-	-	
VJC1 Loop Powered Isolator	<ul style="list-style-type: none"> High accuracy 0.1% of span Two channels in one VJ case (2nd channel output shall be the same as the 1st channel.) 		4 to 20mA DC or 10 to 50mA DC < specify when ordering >	YES	YES	-	-	-	-	-	

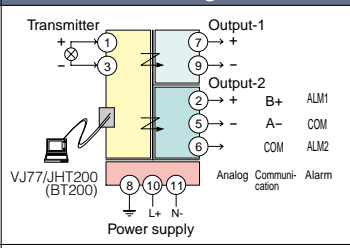
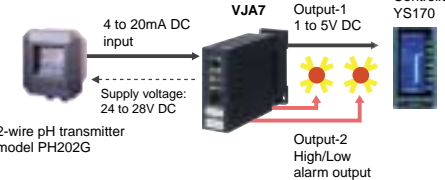
Typical I/O and related model & suffix code (power supply:100 to 240V AC/DC)			
Input	Output-1	Output-2	Model & Suffix codes
1 to 5V DC	4 to 20mA DC	N/A	VJH7-016-1AN0
		4 to 20mA DC	VJH7-026-1AA0
		1 to 5V DC	VJH7-026-1A60
		Communication	VJH7-026-1AP0
		Alarm output	VJH7-026-1AT0
1 to 5V DC	4 to 20mA DC	N/A	VJH1-016-6AN0
		4 to 20mA DC	VJH1-026-6AA0
		1 to 5V DC	VJH1-026-6A60
		-	-
		-	-
1 to 5V DC	4 to 20mA DC	N/A	VJHF-016-6AN0
		4 to 20mA DC	VJHF-026-6AA0
		1 to 5V DC	VJHF-026-6A60
		-	-
		-	-
4 to 20mA DC	1 to 5V DC	1 - channel	VJC1-01N-AA00
		2 - channel	VJC1-02N-AA00
		1 - channel	VJC1-01N-A600
		2 - channel	VJC1-02N-A600
		-	-

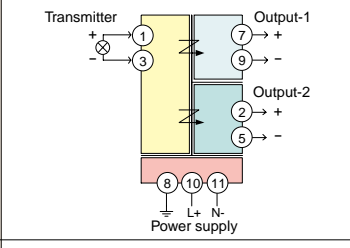
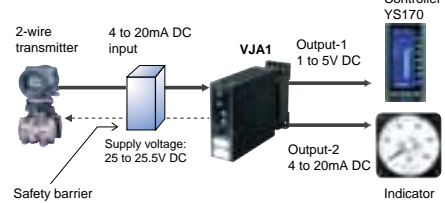
Distributors

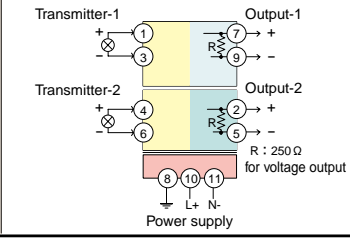
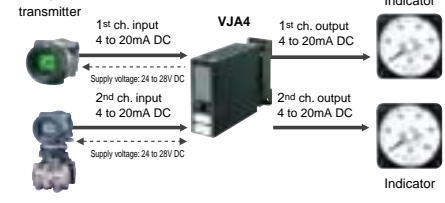
Model	Key words	Block diagram	Input	Output-1			Output-2				Application
				1to5V DC	4to20mA DC	Other analog signal	1to5V DC	4to20mA DC	Alarm	Communi-cation	
VJA7 Distributor Multifunction 	<ul style="list-style-type: none"> High accuracy 0.1% of span 3 year warranty Field configurable 		4 to 20mA DC from 2-wire transmitter Transmitter power supply voltage: 24 to 28V DC	YES	YES	YES	YES	YES	YES	YES	
VJA1 Distributor 	<ul style="list-style-type: none"> High accuracy 0.1% of span 		4 to 20mA DC from 2-wire transmitter Transmitter power supply voltage: 25 to 25.5V DC	YES	YES	YES	YES	YES	-	-	
VJA4 Distributor Non-isolated 	<ul style="list-style-type: none"> High accuracy 0.1% of span 3 year warranty Two channels in one VJ case (2nd channel output shall be the same as the 1st channel.) 		4 to 20mA DC from 2-wire transmitter Transmitter power supply voltage: 24 to 28V DC	YES	YES	-	-	-	-	-	

Typical I/O and related model & suffix code (power supply:100 to 240V AC/DC)			
Input	Output-1	Output-2	Model & Suffix codes
2-wire transmitter	4 to 20mA DC	N/A	VJA7-016-AA00
		4 to 20mA DC	VJA7-026-AAA0
		1 to 5V DC	VJA7-026-AA60
		Communication	VJA7-026-AA00
		Alarm output	VJA7-026-AAT0
2-wire transmitter	4 to 20mA DC	N/A	VJA1-016-AA00
		4 to 20mA DC	VJA1-026-AAA0
		1 to 5V DC	VJA1-026-AA60
		-	-
		-	-
2-wire transmitter	4 to 20mA DC	1 - channel	VJA4-016-AA00
		2 - channel	VJA4-026-AA00
		1 - channel	VJA4-016-A6A0
		2 - channel	VJA4-026-A6N0
		-	-

AC Current and Voltage Converters

Model	Key words	Block diagram	Input	Output-1			Output-2				Application	Typical I/O and related model & suffix code (power supply:100 to 240V AC/DC)			
				1to5V DC	4to20mA DC	Other analog signal	1to5V DC	4to20mA DC	Alarm outputs	Communication		Input	Output-1	Output-2	Model & Suffix codes
VJG1 PT converter RMS-computing	<ul style="list-style-type: none"> PT signal conversion Accuracy 0.5% of span 		0 to 110V AC or 0 to 150V AC, (0 to 300V AC is available) < specify when ordering >	YES	YES	YES	-	-	-	-		0 to 110V AC	4 to 20mA DC	-	VJG1-016-1AN0
				-	-	-	-	-	-	0 to 150V AC		-	-	VJG1-016-2AN0	
VJB1 CT converter RMS-computing	<ul style="list-style-type: none"> CT signal conversion Accuracy 0.5% of span 		0 to 1A AC or 0 to 5A AC CT protector (option) < specify when ordering >	YES	YES	YES	-	-	-	-		0 to 1A AC	4 to 20mA DC	None provided	VJB1-016-AAN0
				-	-	-	-	-	-	0 to 5A AC		4 to 20mA DC	One unit provided	VJB1-016-AAN1	
-	-	-	-	-	-	-	-	-	-	-	-	-	-	-	-

Computing Units

Model	Key words	Block diagram	Input	Output-1			Output-2				Function	Typical I/O and related model & suffix code (power supply:100 to 240V AC/DC)				
				1to5V DC	4to20mA DC	Other analog signal	1to5V DC	4to20mA DC	Contact outputs	Communication		Input	Output-1	Output-2	Model & Suffix codes	
VJSS High/Low Signal Selector CE	<ul style="list-style-type: none"> High accuracy 0.2% of span Isolated single and dual output models 		Two analog input signals 1 to 5V DC or 4 to 20mA DC	YES	YES	YES	YES	YES	-	-	Selects the higher or lower of input -1 and input -2 automatically converts it into isolated analog current signals. 	Hi signal selector	4 to 20mA DC	4 to 20mA DC	N/A	VJSS-H16-AAN0
				-	-	-	-	-	-	-		4 to 20mA DC	4 to 20mA DC	1 to 5V DC	VJSS-H26-AAA0	
VJX7 Universal Computing Unit CE	<ul style="list-style-type: none"> Program steps: 40 steps High accuracy 0.1% of span 3 year warranty Field configurable 		Field configurable 0 to 50mA DC (min. span: 5mA) or -10 to +10V DC (min. span: 0.1V)	YES	YES	YES	YES	YES	YES	YES	VJX7-A Free Program Meet individual applications by programming the various computing functions, 54 commands and 40 steps of capability. Fixed computation models	Low signal selector	4 to 20mA DC	4 to 20mA DC	N/A	VJSS-L16-AAN0
				-	-	-	-	-	-	-		-	-	-	Function: Free program	4 to 20mA DC
-	-	-	-	-	-	-	-	-	-	-	-	-	-	-	-	

Common Features	
<ul style="list-style-type: none"> Output-1 Other analog signals 	2 to 10mA DC, 1 to 5mA DC, 0 to 20mA DC, 0 to 16mA DC, 0 to 10mA DC, 0 to 1mA DC 0 to 10mV DC, 0 to 100mV DC, 0 to 1V DC, 0 to 10V DC, 0 to 5V DC, -10 to +10V DC
<ul style="list-style-type: none"> Output-2 Alarm outputs Communication 	Output signal: N.O. relay contact, 2 points, COM common Contact capacity: 30V DC, 1A Protocol: MODBUS ASCII, MODBUS RTU, PC-link with SUM or ladder Number of connectable instruments: up to 31 units Communication distance: up to 1200m Communication: 1200, 2400, 4800, 9600bps
<ul style="list-style-type: none"> Cables connection Case body material Power supply Withstanding voltage 	M3 screw terminal (Both for signals and power supply) Modified polyphenylene oxide 100 to 240V AC/DC (-15, +10%), 50/60Hz or 15 to 30V DC (±20%) 2000V AC/min. (Between input, outputs, power supply, & ground mutually) 1000V AC/min. (Between output-1 and output-2) 1000V AC/min. (Between input and alarm outputs)
<ul style="list-style-type: none"> External dimensions Weight Environmental conditions UL, CE, CSA markings 	76(H)* 29.5(W)* 124.5(D) mm Approx. 170g Operating temperature: 0 to 50 deg. C Operating humidity: 5 to 90% RH (no condensation) Applicable to the models with 15 to 30V DC power supply

VJX7-B Moving Average Computation Computing of moving average in the number of sampling 	VJX7-C Dead Time Computation Output input value after the dead time has elapsed. Suitable for gravimetry on belt conveyor pipe line control 	VJX7-D First-order Lag Computation Provides a first-order lag computation on input (X) with a time constant (T) and outputs the result.
VJX7-E First-order Lead Computation Used for feed forward control 	VJX7-F Uniform-speed Response (Velocity Limiter) Limit the input velocity at the ascending velocity limit for appositive change and descending velocity limit for negative change and out put the limit value. 	VJX7-G High / Low Limiter Serves as an ordinary converter as long as input is within the upper and lower limits. When the input exceeds the limit, the unit outputs that corresponds to the limit value
VJX7-H Velocity Computation Add a 50% bias to one-half of the obtained velocity and output the result Flow control of rocket fuel 	VJX7-J Linearizer Give an optional relationship between the input(X) and output(Y1 and Y2) signal using an optional line-segment function. The line-segment function has 21 breakpoints, which is useful for capacity calculation of spherical tank. 	VJX7-K Ratio Setting Set the ratio by the following expression $Y1=Y2=K1*(X+A1)+A2$ Where Y1 : Output-1 signal% Y2 : Output-2 signal% X : Input signal% K1 : Ratio(no unit) A1 : A2: Bias %

Plug-in Type Limit Alarms

Highly reliable alarm action

M Series MVHK, MVTK and MVRK are high-performance Digital Limit Alarms.
 Model MVHK: DC Input Type (DC input receives DC current or DC voltage signal.)
 Model MVTK: Thermocouple Input Type
 Model MVRK: RTD Input Type

- Either 2 points of alarms (relay transfer contact [1a1b], 2 points) or 4 points of alarms (relay NO contact, 4 points) can be selected.
- An alarm status in the event of an alarm can be recognized.
- Using the economical mode enables the low power consumption operation.
- Input range and each parameter setting can be changed by the operation keys on the front panel.

VJ Series VJHK, VJAK, VJTK and VJRK are simple-type Limit Alarms.
 Model VJHK: DC Input Type (DC input receives DC current or DC voltage signal.)
 Model VJAK: DC Current Input from 2-wire Transmitter Type
 Model VJTK: Thermocouple Input Type
 Model VJRK: RTD Input Type

- Each parameter setting can be changed using a PC (VJ77 PC-based Parameters Setting Tool) or the Handy Terminal (JHT200).



Ethernet/RS-485 Converter

Easy connection for Ethernet

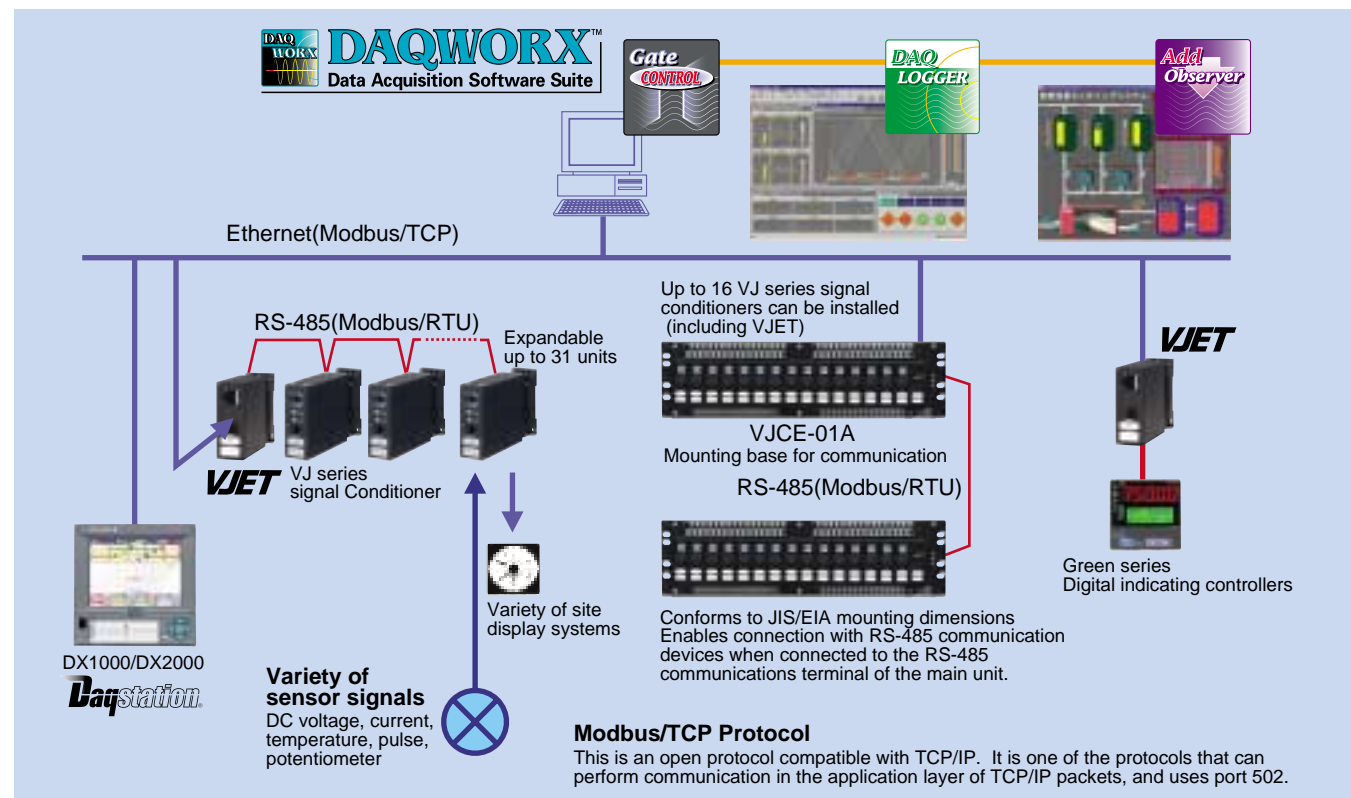

Specifications

Ethernet communication	
Interface	Conforms to IEEE802.3(10BASE-T/100BASE-TX)
Protocol	Modbus/TCP
Access control	CSMA/CD
Transfer rate	10Mbps/100Mbps
Maximum segment length	100m (the length between hub and converter)
Maximum connecting configuration	Up to 4 cascade connection per hub(10BASE-T) Up to 2 cascade connection per hub(100BASE-TX)
Power supply	
Power supply rated voltage	24V DC or 100-240V AC/DC(50/60Hz)
Power consumption	1.8W at 24V DC; 1.5W at 110V DC 2.6VA at 100V AC, 4.0VA at 200V AC

RS-485 communication	
Interface	Conforms to EIA RS-485
Protocol	Modbus/RTU
Transfer system	Half-duplex communication
Synchronous system	Start-stop synchronization
Transfer rate	9600bps
Data length	8
Stop bit	1
Parity	Even, odd or none

Ethernet is a registered trademark of Xerox Corporation.

Accessories

PC-based Parameters Setting Tool

Configure the functions of VJ series signal conditioner from a PC

Model: VJ77

The model VJ77 parameter setting tool is used in combination with VJ series signal conditioner for setting, changing, displaying and printing out parameters such as tag number, input range through simultaneous communication. It also monitors I/O values and selfcheck results, sets alarm setpoints, and allows zero adjustments. The VJ77 is also used for the programming for the model VJX7 universal computing unit. The VJ77 is applicable to the VJ series signal conditioners, models VJH7, VJA7, VJU7, VJQ8, VJP8, VJX7, and the other JUXTAs such as F, W, J series, etc.

Function

Parameter setting	This function enable settings and modification of various parameters of VJ, including input type, input range, output range, and burnout.
Program setting	This function enables programming of universal computing unit (Model VJX7).
Reading & writing data	This function allows the the parameters and programs on the microcomputer-based VJ to be read and then written to the VJ.
File management	This function allows the the programs made with this tool, and the parameters and programs read from the VJ to be saved on a PC's hard disk or other media.
Data printing	This function enables the printing out of programs made with this tool and parameters by a printer.
Monitoring	This function enables the monitoring of inputs, outputs and the results of self-diagnosis the VJ.
Adjustment	This function enables adjustment of the zero point and span of VJ's input/outputs.

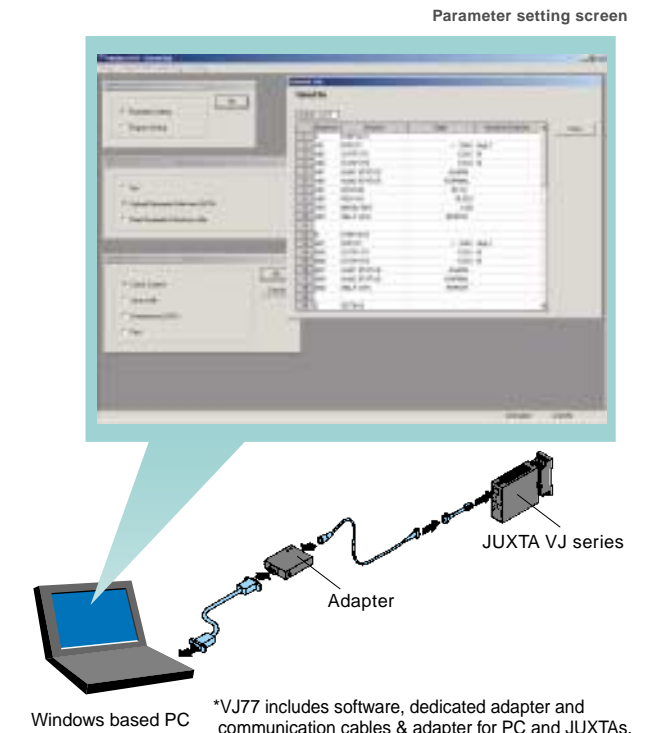

Handy Terminal

Same configuration functions as the VJ77 in a handheld form

Model: JHT200

The model JHT200 handy terminal has the same functions as the VJ77 has, except for the data storage function. The JHT200 is convenient for setting and checking the parameters in the instrumentation panel. The JHT200 is applicable to the same VJ series signal conditioners as the VJ77.

Functional specifications

Basic functions

- Set up, change, and display of parameters
- Zero-point adjustment

Additional functions

- Batch upload/download of data
- Set point protection: Security code entry is required to change set points.

Battery alarm:

- An alarm message appearing on the LCD announces low battery voltages.

Automatic power-off

- The terminal is switched off automatically if no key access is made for approximately 5 minutes.

LCD contrast adjustment

- Printing(JHT200-P00)

Printout Information

- All parameter lists
- Parameter list within each menu item
- Setup change data list
- Uploaded data list
- Display images
- Self check list

Surge Arresters

Protect your process from induced lightning surges

AR series

The high-performance AR surge arrester absorbs the potential of an induced lightning surge caused by a lightning discharge. The plug-in arrester consists of a separable main unit and terminal block.

- Absorbs large surge voltages immediately.
- Simple circuit configuration and excellent adaptability to a distributed control system.
- Plug-in connection of the main unit with the terminal block, eliminating concerns about an open-circuit state even if the main unit is removed.
- CE mark is available for model AR-SA, AR-RT, AR-TC, AR-LP, AR-HP 2nd AR-SP.

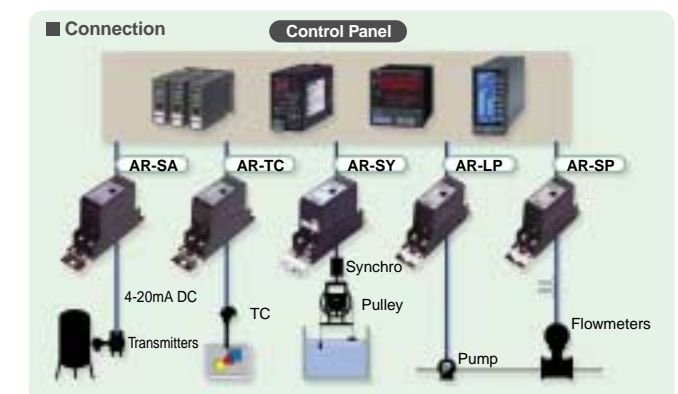

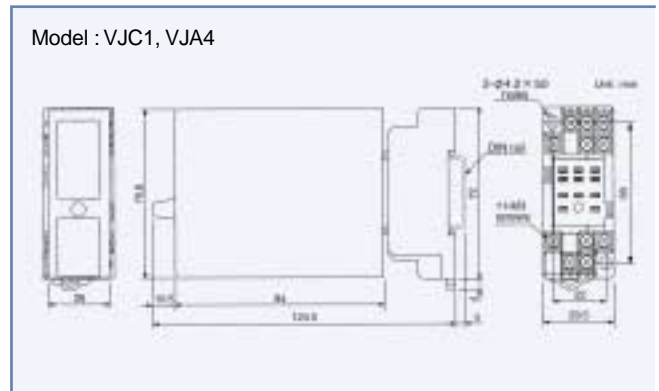
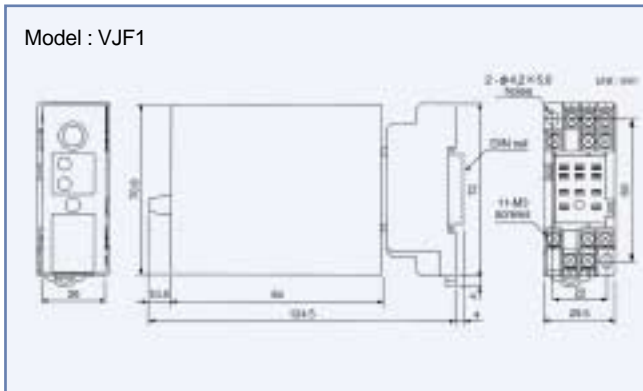
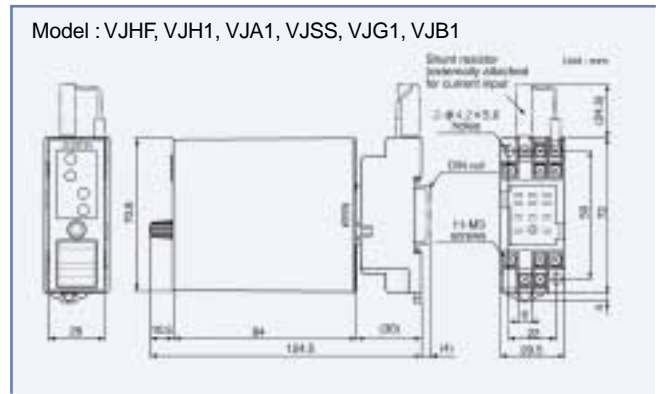
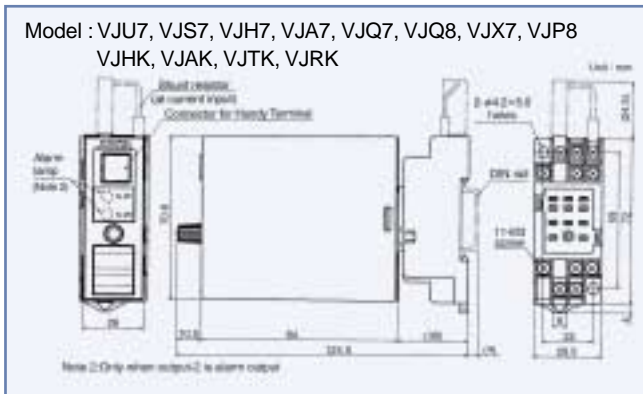

VJ Mounting Base

Model : VJCE-011

Model VJCE mounting base can mount with up to 16 units of VJ series signal conditioners. Easy to connect to an input or output card of Yokogawa's DCS.

Screw terminals or connectors can be selectable for inputs and outputs signal connection.

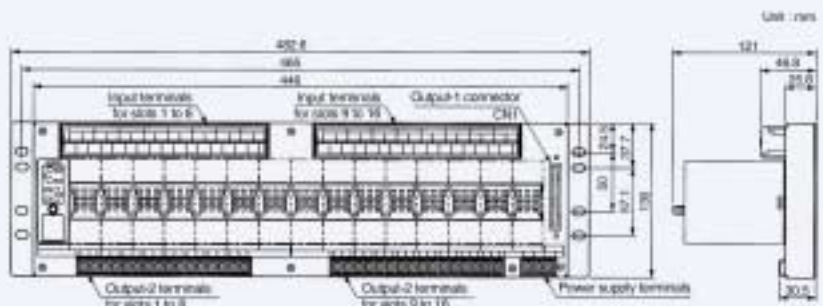

YOKOGAWA

YOKOGAWA CORPORATION OF AMERICA
2 Dart Road, Newnan, Georgia 30265, U.S.A.
Phone: 800-447-9656, Fax: (1)-770-251-6427

YOKOGAWA EUROPE B.V.
Databankweg 20, 3821 AL Amersfoort, THE NETHERLANDS
Phone: (31)-33-4641806, Fax: (31)-33-4641807

YOKOGAWA ENGINEERING ASIA PTE. LTD.
5 Bedok South Road, Singapore 469270
Phone: (65)-62419933, Fax: (65)-62412606

YOKOGAWA ELECTRIC CORPORATION
Network Solutions Business Division
2-9-32 Nakacho, Musashino-shi, Tokyo, 180-8750 Japan
Phone: (81)-422-52-7179, Fax: (81)-422-52-6619
E-mail: ns@cs.jp.yokogawa.com

Represented by :

RM-16E