

DL350
ScopeCorder

U S E R ' S M A N U A L

Thank you for purchasing the DL350 ScopeCorder. This User's Manual explains how to use the DL350. To ensure correct use, please read this manual thoroughly before operation.
After reading this manual, keep it in a safe place.

List of Manuals

The following manuals, including this one, are provided as manuals for the DL350. Please read all manuals.

Manual Title	Manual No.	Description
DL350 ScopeCorder Features Guide	IM DL350-01EN	The supplied CD contains the PDF file of this manual. This manual explains all the instrument's features other than the communication interface features.
DL350 ScopeCorder User's Manual	IM DL350-02EN	This manual. The supplied CD contains the PDF file of this manual. The manual explains how to operate this instrument.
DL350 ScopeCorder Getting Started Guide	IM DL350-03EN	This guide explains the handling precautions and basic operations of this instrument.
DL350 ScopeCorder Communication Interface User's Manual	IM DL350-17EN	The supplied CD contains the PDF file of this manual. The manual explains the instrument's communication interface features and instructions on how to use them.
Precautions Concerning the Modules	IM 701250-04E	The manual explains the precautions concerning the modules. This manual is included if you ordered modules.
Battery Pack Handling Precautions	IM 739883-01EN	This manual is included in models with the /EB option (battery pack + battery pack cover). It explains the handling precautions of the battery pack.
DL350 ScopeCorder	IM DL350-92Z1	Document for China
739883 Battery Pack	IM 739883-92Z1	Document for China This manual is included in models with the /EB option (battery pack + battery pack cover).
720923 Battery Pack Cover	IM 720923-92Z1	Document for China This manual is included in models with the /EB option (battery pack + battery pack cover).

The "EN", "E", and "Z1" in the manual numbers are the language codes.

Contact information of Yokogawa offices worldwide is provided on the following sheet.

Document No.	Description
PIM 113-01Z2	List of worldwide contacts

Notes

- The contents of this manual are subject to change without prior notice as a result of continuing improvements to the instrument's performance and functions. The figures given in this manual may differ from those that actually appear on your screen.
- Every effort has been made in the preparation of this manual to ensure the accuracy of its contents. However, should you have any questions or find any errors, please contact your nearest YOKOGAWA dealer.
- Copying or reproducing all or any part of the contents of this manual without the permission of YOKOGAWA is strictly prohibited.
- The TCP/IP software of this product and the documents concerning it have been developed/created by YOKOGAWA based on the BSD Networking Software, Release 1 that has been licensed from the Regents of the University of California.

Trademarks

- Microsoft, Internet Explorer, Windows, Windows 7, Windows 8, Windows 8.1, and Windows 10 are registered trademarks or trademarks of Microsoft Corporation in the United States and/or other countries.
- Adobe and Acrobat are either registered trademarks or trademarks of Adobe Systems Incorporated.
- PIEZOTRON is a registered trademark of Kistler Instrumente AG.
- ICP is a registered trademark of PCB Piezotronics Incorporated.
- Isotron is a registered trademark of Meggitt Group, PLC.
- VJE is a registered trademark of Yahoo Japan Corporation.
- MATLAB is a registered trademark of The MathWorks, Inc. in the United States.
- ScopeCorder and GIGAZoom ENGINE are registered trademarks of Yokogawa Electric Corporation.
- In this manual, the ® and TM symbols do not accompany their respective registered trademark or trademark names.
- Other company and product names are trademarks or registered trademarks of their respective holders.

Revisions

- 1st Edition: July 2017
- 2nd Edition: December 2017
- 3rd Edition: April 2018

Conventions Used in This Manual

Notes and Cautions

The notes and cautions in this manual are categorized using the following symbols.



Improper handling or use can lead to injury to the user or damage to the instrument. This symbol appears on the instrument to indicate that the user must refer to the user's manual for special instructions. The same symbol appears in the corresponding place in the user's manual to identify those instructions. In the manual, the symbol is used in conjunction with the word "WARNING" or "CAUTION."

WARNING

Calls attention to actions or conditions that could cause serious or fatal injury to the user, and precautions that can be taken to prevent such occurrences.

CAUTION

Calls attention to actions or conditions that could cause light injury to the user or damage to the instrument or user's data, and precautions that can be taken to prevent such occurrences.

French

AVERTISSEMENT

Attire l'attention sur des gestes ou des conditions susceptibles de provoquer des blessures graves (voire mortelles), et sur les précautions de sécurité pouvant prévenir de tels accidents.

ATTENTION

Attire l'attention sur des gestes ou des conditions susceptibles de provoquer des blessures légères ou d'endommager l'instrument ou les données de l'utilisateur, et sur les précautions de sécurité susceptibles de prévenir de tels accidents.

Note

Calls attention to information that is important for the proper operation of the instrument.

Unit

k	Denotes 1000. Example: 100 kS/s (sample rate)
K	Denotes 1024. Example: 720 KB (file size)

Operation Screen and Common Operations

Operation Screen and Descriptions

This manual explains procedures using English menu screens. In procedural explanations, applicable menus and items are indicated with bold characters (e.g., **Setup**).

For instructions on how to set the menu language, see section 20.3.

Touch Panel Operations

The basic touch panel operations are described below.

Tap

Tap refers to the act of gently hitting the screen with your finger.

Tapping is used on the instrument screen to select areas with a mark, close a setup menu, and so on.



Drag, Swipe, and Slide

Press your finger against the screen and move your finger across the screen.

Drag refers to the act of selecting and moving items, such as a trigger level icon.

Swipe refers to the act of moving a relatively wide display range, such as scrolling the setting screen.

Slide is also a term sometimes used depending on the movement operation.

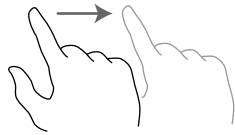

Pinch Out and Pinch In

Pinch out refers to the act of pressing two fingers against the screen and spreading them apart.

Pinch in refers to the act of pressing two fingers against the screen and drawing them together.

On a screen displaying waveforms, you can pinch out to zoom in and pinch in to zoom out.

Pinch out

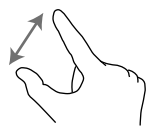

Pinch in



Entering Values

When a control for entering a value is displayed (such as the one shown below), tapping the value area opens an input box (numeric keypad). After entering a value with the numeric keypad, tap **Enter** to confirm the value.

Example of a Control for Entering a Value

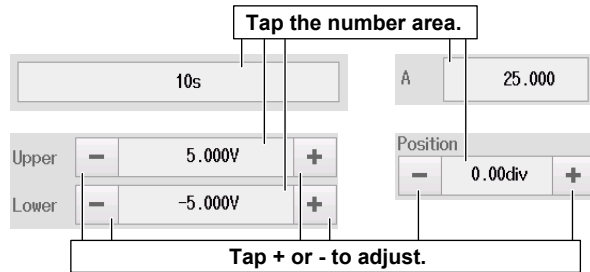

- The least significant digit increases or decreases. Carrying over and borrowing occur automatically.
- Holding down + or - changes the value consecutively.

Example of an Input Box (Numeric keypad)

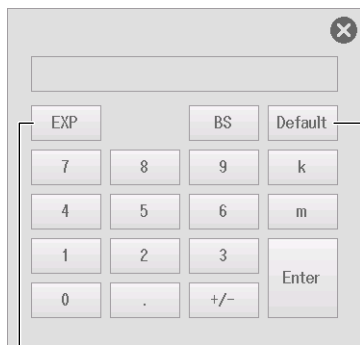

Tap here to set the default value and close the input box (numeric keypad).
(You do not need to tap Enter.)

Tap to enter an exponent.

Entering Character Strings

Use the keyboard that appears on the screen to enter character strings such as file names and comments.

The keyboard used in the next example has the message language (see section 20.3) set to English.

How to Operate the Keyboard

1. With the keyboard displayed, tap the character you want to enter.
2. Repeat step 1 to enter all of the characters in the string.
3. Tap **ENTER**. The character string is confirmed, and the keyboard disappears.

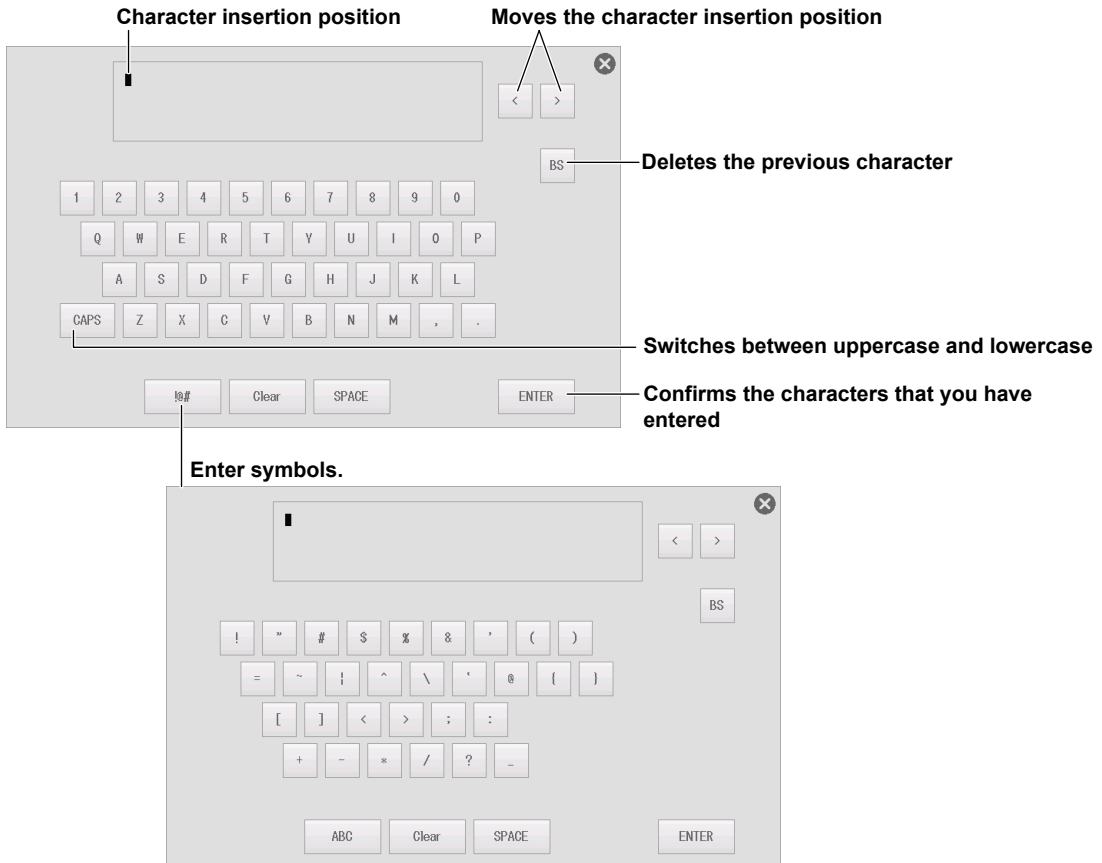

Note

- @ cannot be entered consecutively.
- File names are not case-sensitive. Comments are case-sensitive. The following file names cannot be used due to MS-DOS limitations:
AUX, CON, PRN, NUL, CLOCK, COM1 to COM9, and LPT1 to LPT9

Menu Shown in the Footer Area

A menu is shown in the footer area of the waveform screen. You can set various items by using the menu, list (options), or input box that appears when you tap the menu commands.

For Scope Mode

When the Time Base¹ Is Internal

Top menu

This is the entrance to the setup menu of each function.

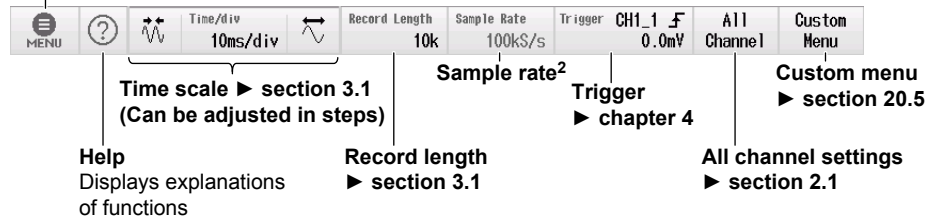

When the Time Base¹ Is External

Top menu

This is the entrance to the setup menu of each function.

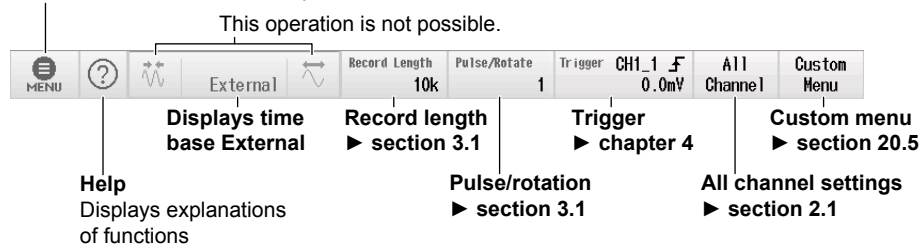

1 For setting the time base in scope mode, see section 3.1.

2 The sample rate varies depending on the time scale and record length settings.

For Recorder Mode

When the Acquisition Method* Is Set to Memory, Memory + Save on Stop, or Memory + SD Numeric Recording

- When the Time Base* Is Internal

Top menu

This is the entrance to the setup menu of each function.

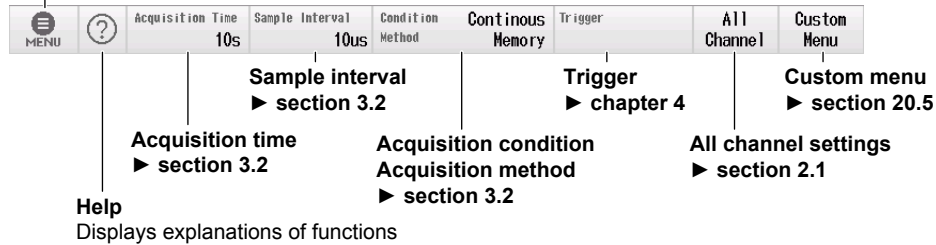

- When the Time Base* Is External

Top menu

This is the entrance to the setup menu of each function.

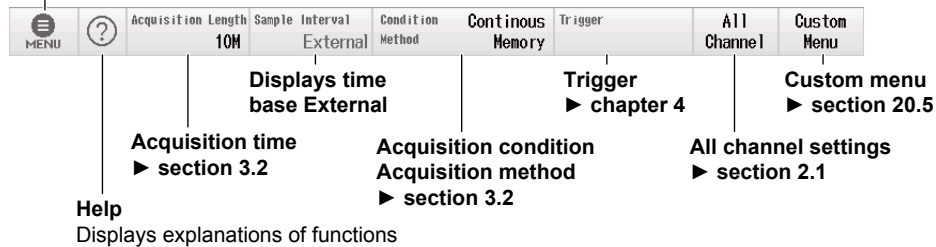

When the Acquisition Method* Is Set to SD Recording

- When the Time Base* Is Internal

Top menu

This is the entrance to the setup menu of each function.

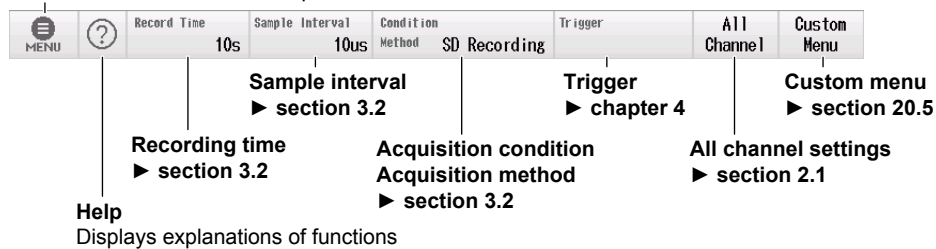

- When the Time Base* Is External

Top menu

This is the entrance to the setup menu of each function.

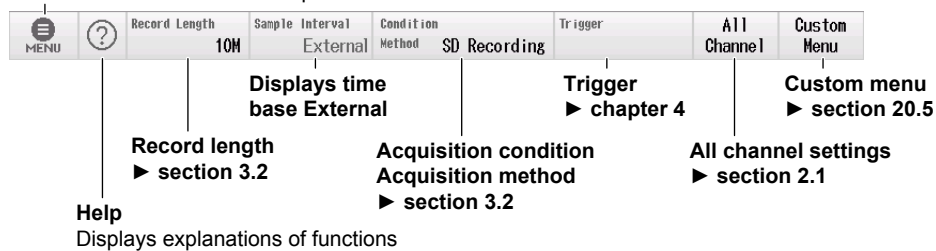

* For setting the acquisition method and time base in recorder mode, see section 3.2.

Contents

List of Manuals.....	i
Conventions Used in This Manual	iii
Operation Screen and Common Operations.....	iv

Chapter 1 What to Set First

1.1	Selecting Scope Mode or Recorder Mode	1-1
1.2	Loading Setup Files.....	1-2
1.3	Configuring the Recorder Mode Using the Easy Setup.....	1-4
1.4	Initializing the Settings.....	1-8
1.5	Performing Auto Setup	1-9
1.6	Calibrating the Instrument	1-10

Chapter 2 Vertical Axis

2.1	Configuring on the All Channels Setup Screen	2-1
 2.2	Configuring Voltage Measurements	2-4
2.3	Configuring Voltage Measurements (For 16-CH voltage input modules)	2-10
2.4	Configuring Temperature Measurements	2-15
2.5	Configuring Temperature Measurements (For 16-CH temperature/voltage input modules).....	2-17
2.6	Configuring Strain Measurements.....	2-22
2.7	Configuring Acceleration Measurements.....	2-24
2.8	Configuring Frequency, Revolution, Period, Duty Cycle, Power Supply Frequency, Pulse Width, Pulse Integration, and Velocity Measurements.....	2-27
2.9	Configuring Logic Signal Measurements.....	2-34
2.10	Configuring the Monitoring of CAN and CAN FD Bus Signals (/VE option).....	2-36
2.11	Configuring the Monitoring of LIN Bus Signals (/VE option).....	2-42
2.12	Configuring the Monitoring of SENT Signals (/VE option).....	2-46
2.13	Configuring the GPS Position Information Monitor.....	2-51

Chapter 3 Waveform Acquisition

3.1	Setting Conditions for Waveform Acquisition (Scope mode).....	3-1
3.2	Setting Conditions for Waveform Acquisition (Recorder mode)	3-5
3.3	Starting and Stopping Waveform Acquisition	3-10

Chapter 4 Triggering

4.1	Setting the Trigger Mode	4-1
4.2	Setting the Trigger Position and Trigger Delay.....	4-2
4.3	Triggering on an Edge Trigger.....	4-3
4.4	Triggering on a Timer Trigger	4-5
4.5	Triggering on an External Trigger	4-7
4.6	Triggering on an Edge Trigger of a Logic Signal	4-9
4.7	Triggering on an Edge On A Trigger	4-11
4.8	Triggering on an OR Trigger.....	4-12
4.9	Triggering on an AND Trigger.....	4-14
4.10	Triggering on a Period Trigger.....	4-16
4.11	Triggering on a Pulse Width Trigger	4-18
4.12	Triggering on a Wave Window Trigger	4-20
4.13	Triggering the Instrument Manually (Manual Trigger).....	4-21

Chapter 5 Display

5.1	Setting Display Groups and Display Format	5-1
5.2	Setting the Waveform Arrangement, Color, and Grouping	5-2
5.3	Configuring the Display Preferences	5-4
5.4	Using the Snapshot and Clear Trace Features	5-7
5.5	Setting the Display Time and Display Position	5-8
5.6	Auto Scrolling the Display Range	5-9

Chapter 6 Saving and Loading Data

▲ 6.1	Connecting a Storage Device	6-1
6.2	Formatting an SD Memory Card	6-4
6.3	Saving Waveform Data	6-5
6.4	Saving Setup Data	6-10
6.5	Saving Other Types of Data	6-11
6.6	Setting the SAVE Key Function	6-15
6.7	Loading Waveform Data	6-20
6.8	Loading Setup Data	6-21
6.9	Loading Other Types of Data	6-22
6.10	Performing File Operations	6-24

Chapter 7 Cursor Measurement

7.1	Measuring with Horizontal Cursors	7-1
7.2	Measuring with Vertical Cursors	7-2
7.3	Measuring with Marker Cursors	7-3
7.4	Measuring with Angle Cursors	7-5
7.5	Measuring with Horizontal and Vertical Cursors	7-7

Chapter 8 Automated Measurement of Waveform Parameters

8.1	Automatically Measuring Waveform Parameters	8-1
8.2	Performing Continuous Statistical Processing	8-5
8.3	Performing Cyclic Statistical Processing	8-6
8.4	Performing Statistical Processing on History Waveforms	8-8
8.5	Saving Automated Measurement Values of Waveform Parameters	8-9

Chapter 9 Computation

9.1	Setting Equations	9-1
9.2	Setting the Display Conditions for Computed Waveforms	9-5
9.3	Setting the Computation Range and Averaging	9-6

Chapter 10 FFT

10.1	Setting Conversion Equations	10-1
10.2	Setting the Vertical Axis of the FFT	10-2
10.3	Setting the Horizontal Axis of the FFT	10-3
10.4	Setting the Analysis Start Point, Number of FFT Points, Window Function, and Averaging	10-4
10.5	Measuring FFT Waveforms with Cursors	10-6
10.6	Saving the Results of FFT Analysis	10-9

Chapter 11 X-Y Waveform

11.1	Setting the X-Y Waveform Trace	11-1
11.2	Setting the Display Conditions for X-Y Waveforms	11-2
11.3	Measuring X-Y Waveforms with Cursors	11-3

Chapter 12 Harmonic Analysis

12.1 Setting the Harmonic Analysis Conditions..... 12-1
 12.2 Setting the Harmonic Analysis Display Conditions..... 12-3
 12.3 Setting the Harmonic Analysis Save Conditions 12-4

Chapter 13 GO/NO-GO Determination (Scope mode only)

13.1 Performing GO/NO-GO Determination with Waveform Zones 13-1
 13.2 Performing GO/NO-GO Determination with Waveform Parameters 13-5

Chapter 14 Waveform Zoom (Scope mode only)

14.1 Setting the Waveform Zoom Range 14-1
 14.2 Setting the Display Conditions for Waveforms 14-2
 14.3 Auto Scrolling the Zoom Position 14-4

Chapter 15 Waveform Display Range and Zoom (Recorder mode only)

15.1 Setting the Waveform Display Range and Zoom Range..... 15-1
 15.2 Setting the Display Conditions for Waveforms 15-2
 15.3 Auto Scrolling the Zoom Position 15-3

Chapter 16 Searching Waveforms

16.1 Searching for Edges..... 16-1
 16.2 Searching for Events 16-5
 16.3 Searching for Logic Patterns 16-6
 16.4 Searching for a Specific Date and Time 16-7

Chapter 17 History Waveforms (Scope mode only)

17.1 Displaying Waveform History Waveforms 17-1

Chapter 18 Position Information (GPS)

18.1 Acquiring Position Information..... 18-1

Chapter 19 Ethernet Communication

19.1 Connecting the Instrument to a Network 19-1
 19.2 Configuring TCP/IP Settings..... 19-3
 19.3 Monitoring the Instrument's Display from a PC (Web Server)..... 19-4
 19.4 Connecting to a Network Drive..... 19-5
 19.5 Configuring Mail Transmission (SMTP client)..... 19-6
 19.6 Using SNTP to Set the Date and Time..... 19-7
 19.7 Configuring the VXI-11 19-8

Chapter 20 Other Operations

20.1 Setting the Date and Time 20-1
 20.2 Configuring the LCD 20-2
 20.3 Setting the Message Language, Menu Language, and USB 20-3
 20.4 Adding Options to the DL350 20-4
 20.5 Setting Preferences 20-5

Index

1.1 Selecting Scope Mode or Recorder Mode

This section explains how to select scope mode or recorder mode.

- Navigation
- Scope Mode and Recorder Mode

► [Features Guide: "Navigation"](#)

Navigation Screen

When you start the instrument, the navigation screen appears.

Tap the measurement mode and then **Start**. The waveform screen for the selected mode appears.

Navigation Screen

To select scope mode

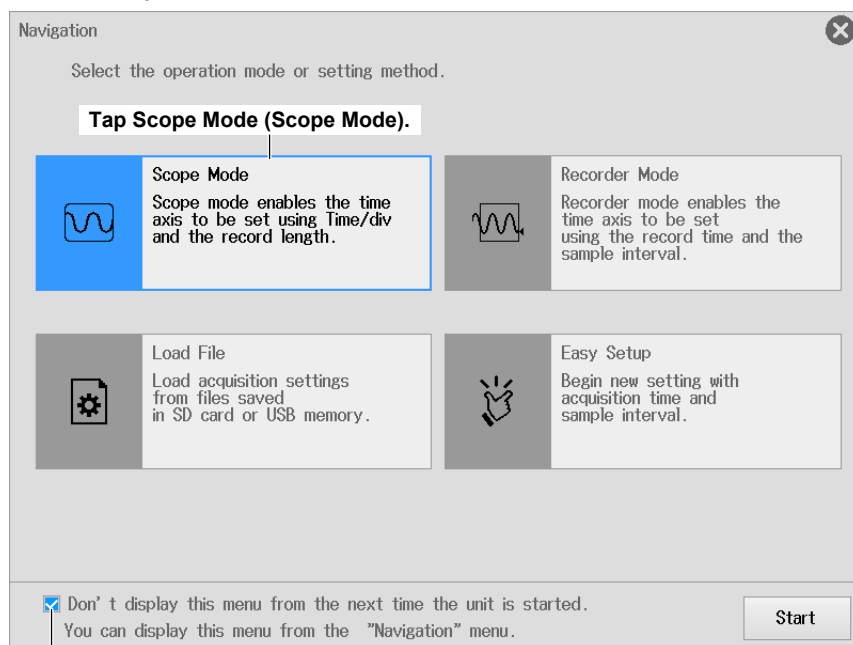

If you select this check box, the waveform screen will appear the next time you start the instrument. Tapping **MENU > Navigation** on the waveform screen displays this navigation screen.

To select recorder mode

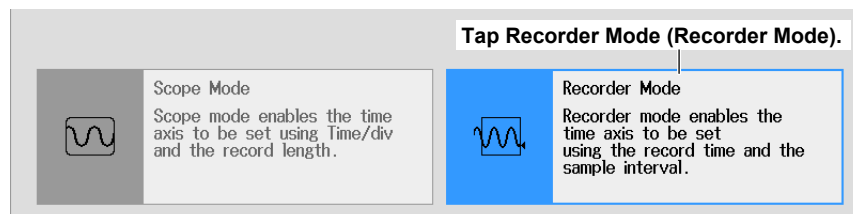

1.2 Loading Setup Files

This section explains how to use the navigation feature to load a setup file according to your application.

- Navigation
- Setup file
- Executing the load

► [Features Guide: "Navigation"](#)

Navigation Screen

When you start the instrument, the navigation screen appears.

Tap **Load File** and then **Start**. A file list appears.

Navigation Screen

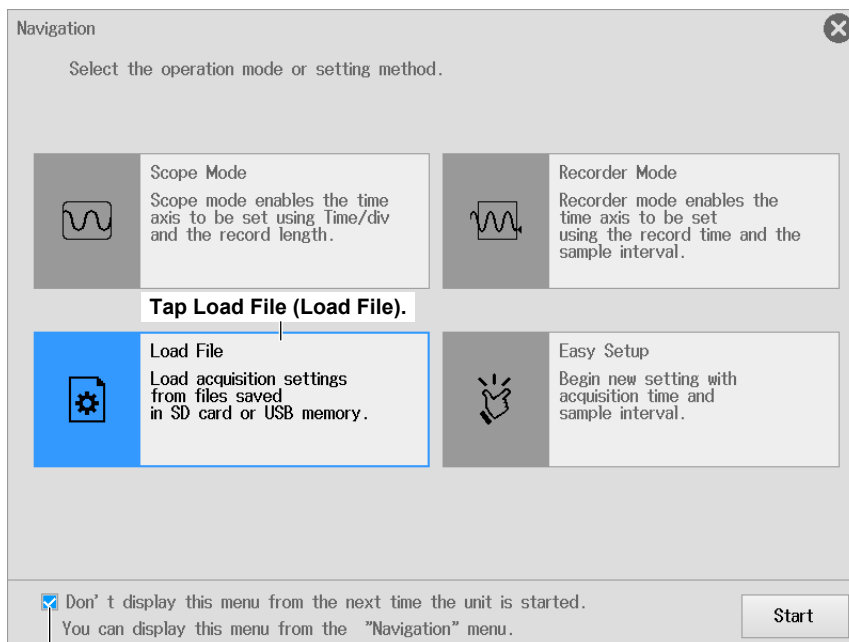

If you select this check box, the waveform screen will appear the next time you start the instrument. Tapping **MENU > Navigation** on the waveform screen displays this navigation screen.

Selecting a Setup File

1. On the file list, tap the setup file you want to load.
2. Tap **Load**. A confirmation message appears.

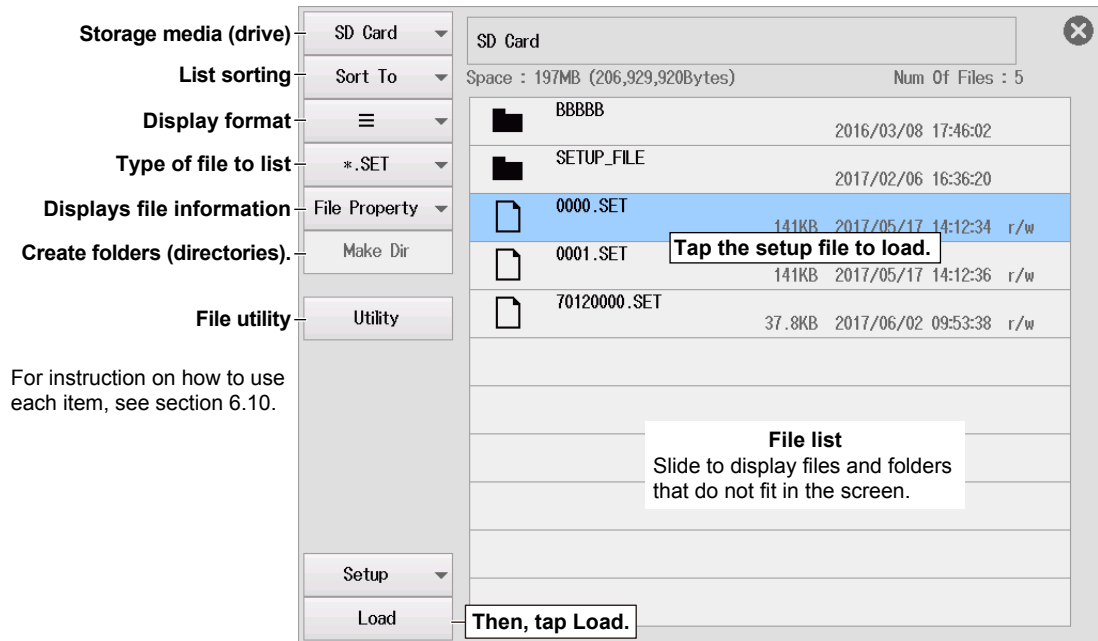

Executing the Load

3. Tap **OK**. The setup file is loaded.

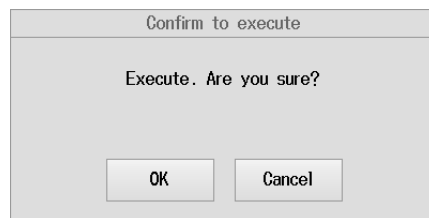

1.3 Configuring the Recorder Mode Using the Easy Setup

This section explains how to use the wizard of the navigation feature to configure the recorder mode settings.

- Navigation
- Turning recording channels on and off
- Recording time
- Sample interval
- All channels setup menu

► [Features Guide: "Navigation"](#)

Navigation Screen

When you start the instrument, the navigation screen appears.

Tap **Easy Setup** and then **Start**. A Select Channel screen appears.

Navigation Screen

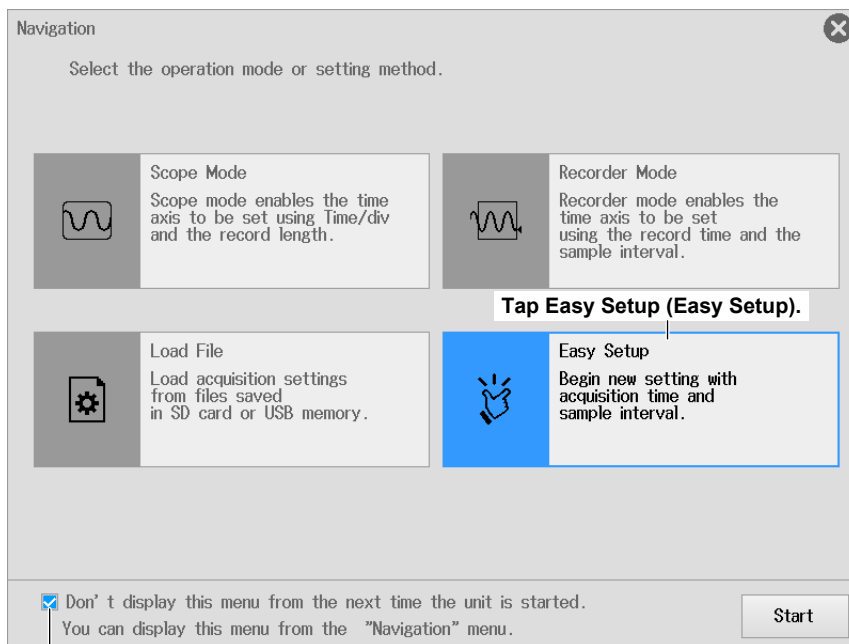

If you select this check box, the waveform screen will appear the next time you start the instrument. Tapping **MENU > Navigation** on the waveform screen displays this navigation screen.

Turning Recording Channels On and Off

1. Tap the check box of each channel.
 - Select the check boxes of the channels you want to record. Clear the check boxes otherwise.
 - For the detail settings of the instrument's internal logic, see section 2.9. For the detail settings of the GPS, see chapter 18.
2. Tap **Next**. A Recording time screen appears.
Tapping **Cancel** displays the waveform screen.

Channel Selection Screen

Easy Setup

1. Select Channel 2. Recording time 3. Sample interval

Please select the channel to record.
(Setting of range etc. of each channel is not performed here)

Slot 1 (701275)

CH1 CH2

Slot 2 (720250)

CH3 CH4

Built-in Logic GPS

CH5 CH6 CH7

Built-in Logic CH6 and GPS CH7,
They cannot be recorded at the same time.

Next > Cancel

**16CH module (720220 (16CH VOLT),
720221 (16CH TEMP/VOLT))**

Slot 1 (720221)

CH1

Slot 2 (720254)

CH3_1 CH3_2 CH4_1 CH4_2

Setting the Record Time

1. Tap the **record time value**. An input box appears.
2. Use the input box to set the record time.
 - Set in the range of 10 s to 50 days.
If you enter the value and unit and then tap **Enter**, the input record time is applied.
If you enter only the value and tap **Enter**, the input value is assumed to be in seconds (s).
If you do not enter the value or unit and tap **Enter**, the default value is applied.
 - The following combinations of time units can be used. Other combinations are not allowed.
Minutes and seconds, hours and minutes, days and hours
3. Tap **Next**. A Sample interval screen appears.
 - Tapping **< Back** displays the Select Channel screen.
 - Tapping **Cancel** displays the waveform screen.

Recording Time Screen

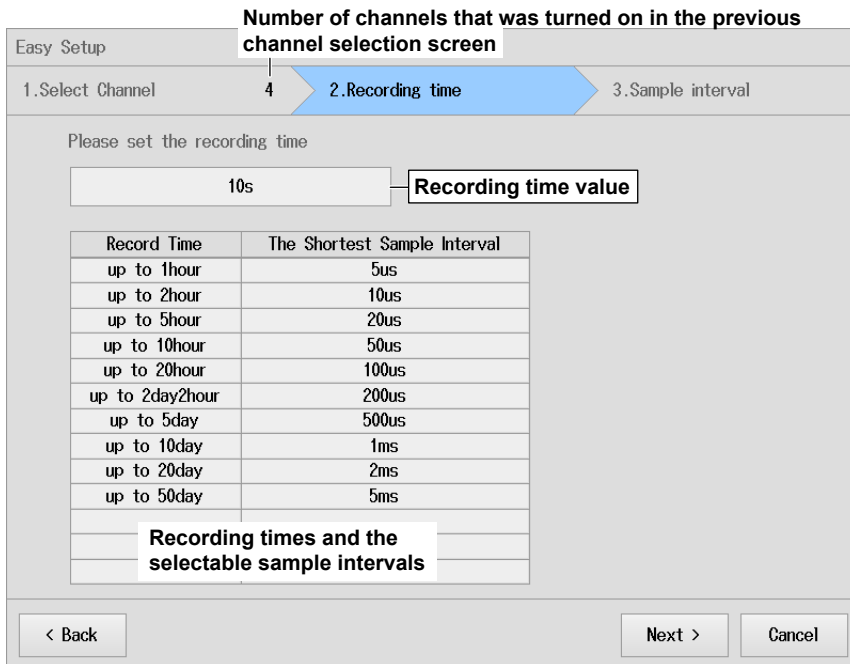

Input Box That Appears When You Tap the Record Time Value

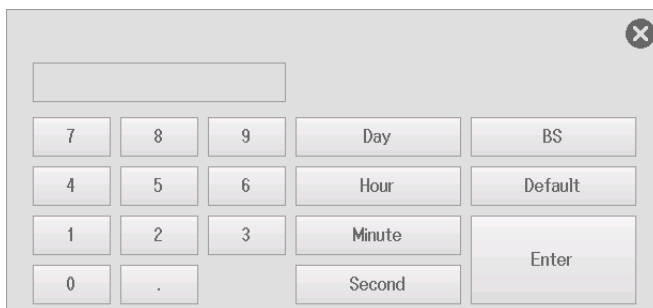

Setting the Sample Interval

1. Tap the **sample interval value**. On the list of available options, tap the sample interval you want to use.
 - The content of the list varies depending on the number of recording channels and record time.
 - The sample rate and recording data size vary according to the specified sample interval.
2. Tap **Finish**. An All Channel Setup screen appears.
 - Tapping **< Back** displays the Recording time screen.
 - Tapping **Cancel** displays the waveform screen.

Sample Interval Screen

List box that appears when you tap the sample interval value



The content of the sample interval list varies depending on the number of channels and record time.

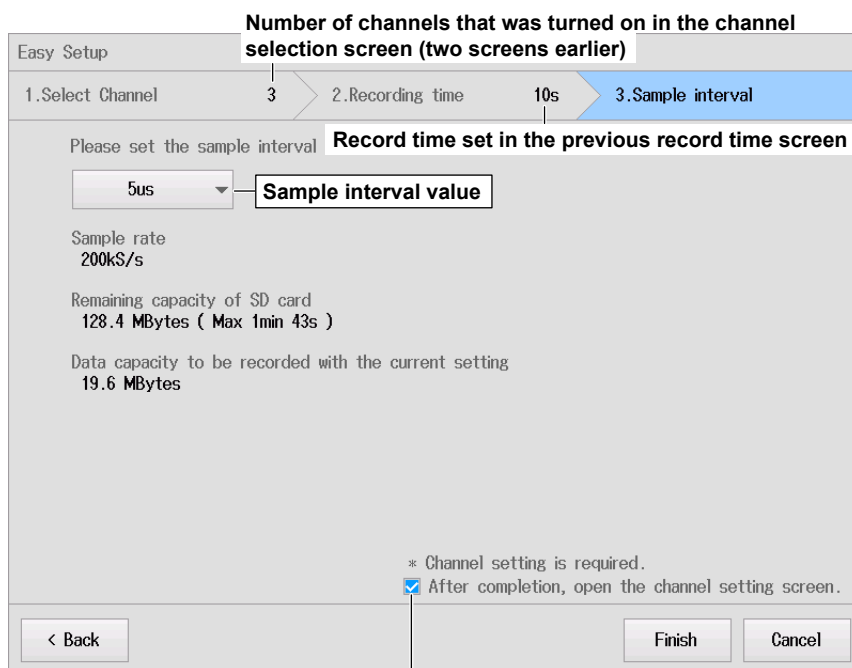

Clearing this check box and tapping **Finish** opens the waveform screen.

Example of the All Channels Setup Screen

For the setting procedure on the All Channels Setup screen, see section 2.1.

All Channels Setup				Setup	Linear Scale	Channel Copy	Balance/Offset	Cancel	
	Disp	Label	Bit Display	Chatter Elim.		Position	V Zoom	Mapping	
All	<input checked="" type="checkbox"/>								
1	<input checked="" type="checkbox"/>	CH1	DC	500V	Full	250.00V	-250.00V	10:1	
2	<input checked="" type="checkbox"/>	CH2	DC	500V	Full	250.00V	-250.00V	10:1	
3	<input checked="" type="checkbox"/>	CH3	DC	500V	Full	250.0V	-250.0V	10:1	
4	<input checked="" type="checkbox"/>	CH4	DC	500V	Full	250.0V	-250.0V	10:1	
5	<input type="checkbox"/>	CH5				0.00div	x 1	Auto	
6	<input type="checkbox"/>	CH6				0.00div	x 1	Auto	
_1		Bit1	<input checked="" type="checkbox"/>	OFF					
_2		Bit2	<input checked="" type="checkbox"/>	OFF					
_3		Bit3	<input checked="" type="checkbox"/>	OFF					
_4		Bit4	<input checked="" type="checkbox"/>	OFF					

1.4 Initializing the Settings

This section explains how to initialize the settings to their factory default values.

► [Features Guide: “Initialization of Settings \(Initialize\)”](#)

1. On the waveform screen, tap **MENU > Preparation**. The following menu appears.
2. Tap **Initialize**. A confirmation message appears.

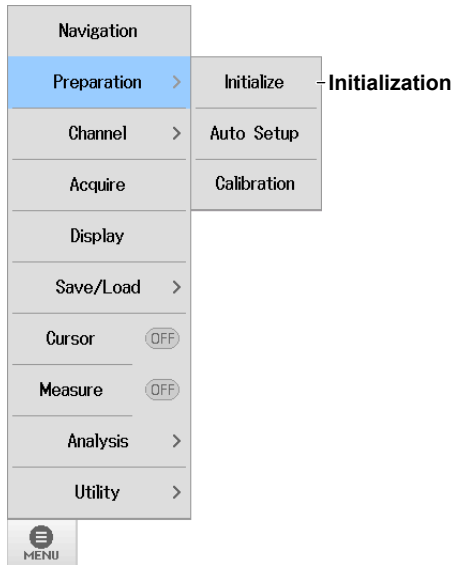

Executing Initialization

3. Tap **OK**. Initialization is executed.

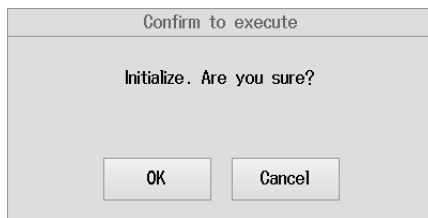

Settings That Cannot Be Reset to Their Factory Default Values

- Date and time settings
- Communication settings
- Language setting (English or Japanese)
- System mode
- Network settings

1.5 Performing Auto Setup

This section explains how to perform auto setup, which automatically sets the instrument's settings to the values that are most suitable for the input signals.

► [Features Guide: "Auto Setup \(Auto Setup\)"](#)

1. On the waveform screen, tap **MENU > Preparation**. The following menu appears.
2. Tap **Auto Setup**. A confirmation message appears.

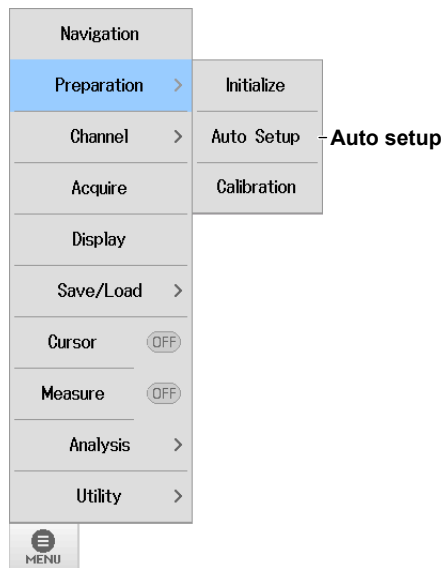

Executing Auto Setup

3. Tap **OK**. Auto setup is executed.

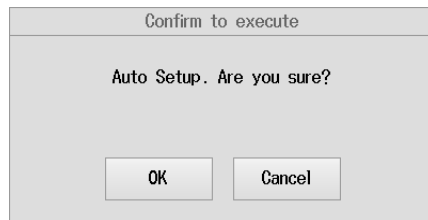

1.6 Calibrating the Instrument

This section explains how to calibrate the instrument. Execute calibration when you want to make accurate measurements.

► [Features Guide: “Calibration \(Calibration\)”](#)

1. On the waveform screen, tap **MENU > Preparation**. The following menu appears.
2. Tap **Calibration**. A calibration menu appears.



Calibration

Executing Calibration

Tap **Execute**. Calibration is executed.

Turning Auto Calibration On and Off

Tap **ON** or **OFF** under Auto CAL.

To enable auto calibration, select ON. Otherwise, select OFF.

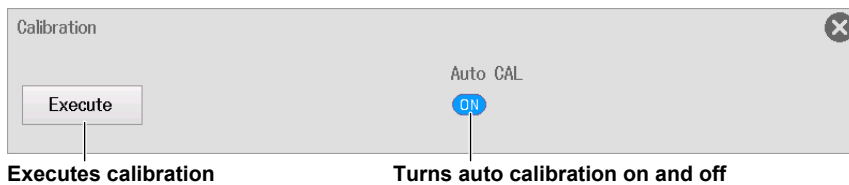

2.1 Configuring on the All Channels Setup Screen

This section explains the following settings for configuring all channels.

- Input settings
- Linear scaling
- Copying channels
- Balancing and offset canceling
(Strain balancing (strain module) and DC offset cancellation)

► **Features Guide: “All Channel Settings (All CH Setup)”**

On the waveform screen, tap **MENU > Channel > All CH Setup**. An All Channels Setup screen appears.

You can also display the All Channels Setup screen by tapping **All Channel** on the bottom menu bar of the waveform screen.

All Channel Setup Screen Input Settings (Setup)

1. Tap the **Setup** tab. An input setting screen appears.
The items on the input setting screen vary depending on the installed modules and measurement items. For details on the settings, see the explanation of each measurement item in section 2.2 and later.
2. Tap the items of each channel. Use the displayed list (options) or input box to set the items.

Example of an Input Setting Screen in Scope Mode

To collectively turn the waveform display of all channels on and off, set Disp in the All row.

Turns the waveform display on and off

Display label

Input coupling

Vertical scale

Bandwidth limit

Vertical scale

Vertical position

Set the zoom magnification.

Probe attenuation and current-to-voltage conversion ratio

	Disp	Label	Coupling	V/div	Band Width	DIV/SPAN	Position	V Zoom	Probe
All	<input checked="" type="checkbox"/>								
1	<input checked="" type="checkbox"/>	CH1	DC	0.5V/div	Full	DIV	0.00div	x 1	10:1
2	<input type="checkbox"/>	CH2	DC	50V/div	Full	DIV	0.00div	x 1	10:1
3	<input type="checkbox"/>	CH3	DC	5V/div	Full	DIV	0.00div	x 1	1:1
4	<input type="checkbox"/>	CH4	DC					x 1	1:1
5	<input type="checkbox"/>	CH5					0.00div	x 1	Auto
6	<input type="checkbox"/>	CH6					0.00div	x 1	Auto

Channels 5 and 6 are built-in logic signal measurement channels of the instrument. Tap + to set each bit.

Slide to display channels that do not fit in the screen.

2.1 Configuring on the All Channels Setup Screen

Example of an Input Setting Screen in Recorder Mode

To collectively turn the waveform display of all channels on and off, set Disp in the All row.

Turns the waveform display on and off

Display label

Input coupling

Measurement range

Bandwidth limit

Upper and lower limits of the display range

Probe attenuation and current-to-voltage conversion ratio

All Channels	Setup	Setup	Linear Scale	Channel Copy	Balance/Offset	Cancel		
Disp	Label	Coupling	V Range	Band Width	Upper	Lower	Probe	
All	ON							
1	ON	CH1	DC	5V	Full	1225.00	-1275.00	10:1
2	OFF	CH2	DC	500V	Full	6225.00	-6275.00	10:1
3	OFF	CH3	DC	50V	Full	25.00V	-25.00V	1:1
4	OFF	CH4	DC				-25.00V	1:1
5	+	OFF				0.00div	x 1	Auto
6	+	OFF				0.00div	x 1	Auto

Channels 5 and 6 are built-in logic signal measurement channels of the instrument. Tap + to set each bit.

Slide to display channels that do not fit in the screen.

Linear Scaling (Linear Scale)

1. Tap the **Linear Scale** tab. The Linear Scale screen appears.
For details on the settings, see the explanation of linear scaling in section 2.2.
2. Tap the items of each channel. Use the displayed list (options) or input box to set the items.

Linear scaling mode

Scaling coefficient A or measured value at point P1

Offset value B or scaled value of point P1

Measurement value of point P2

Scaled value of point P2

Display mode

Number of decimal places

Unit

Unit prefix

All Channels	Setup	Setup	Linear Scale	Channel Copy	Balance/Offset	Cancel						
Linear Scale	AX+B: A P1-P2	P1:X	AX+B: B P1-P2	P1:Y	P1-P2	P2:X	P1-P2	P2:Y	Unit	Disp Type	Decim Num	Sub Unit
1	AX+B	25.000	-25.000							Float	Auto	k
2	P1-P2	1.0000	0.0000	5.0000		100.00				Exp		
3	OFF											
4	OFF											
5	+											
6	+											

Linear scaling is not possible on channels 5 and 6 because they are logic signals.

Slide to display channels that do not fit in the screen.

Copying Channels (Channel Copy)

1. Tap the **Channel Copy** tab. The Channel Copy screen appears.
2. Tap each item to set options from the displayed list or execute commands.

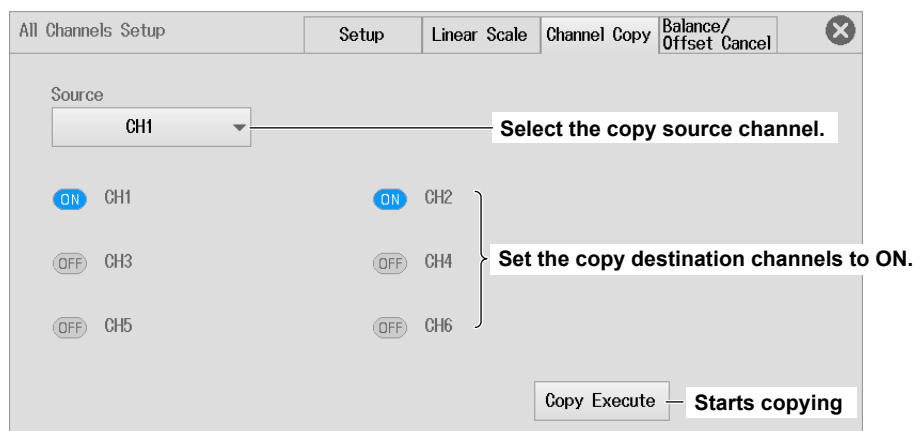

Balancing and Offset Canceling (Balance/Offset Cancel)

1. Tap the **Balance/Offset Cancel** tab. The Balance/Offset Cancel screen appears.
For instructions on how to set balancing and DC offset cancellation, see the explanation of DC offset cancellation in section 2.2 and strain balance in section 2.6.
2. Tap each item to set options and execute commands.

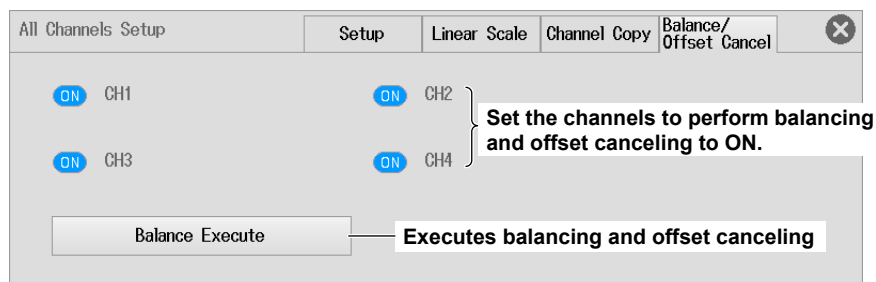

2.2 Configuring Voltage Measurements

This section explains the following settings for the vertical axis of voltage measurements.

For Scope Mode

- Basic settings (waveform display on/off, vertical scale, input coupling, bandwidth limit, probe attenuation, current-to-voltage conversion ratio, display labels)
- Display settings (vertical scale (zoom method), vertical position, vertical zoom (zooming by setting the magnification), zooming by setting the high limit and low limit of the display range, waveform inverted display on/off, display groups)
- Detail settings (linear scaling, channel copying, gain adjustment, DC offset cancellation on/off)

For Recorder Mode

- Basic settings (waveform display on/off, measurement range, input coupling, bandwidth limit, probe attenuation, current-to-voltage conversion ratio, display labels)
- Display settings (high limit and low limit of the display range, waveform inverted display on/off, display groups)
- Detail settings (linear scaling, channel copying, gain adjustment, DC offset cancellation on/off)

► [Features Guide: "Voltage Measurement"](#)

Channel Setting Menu

1. On the waveform screen, tap **MENU > Channel >** any channel from **CH1 to CH4**. A channel setting menu appears.
 - You can also tap or double-tap any channel from CH1 to CH4 in the channel information area to display the channel setting menu. (If the channel is selected, tap; otherwise, double-tap.)
 - For a 4-CH module (720254 (4CH 1M16)), select the sub channel (if the display label is set to default, the channel number followed by an underscore and a number as in CH3_1).

Basic Setup (Basic)

2. Tap the **Basic** tab.
3. Tap each item. Use the displayed list (options) or input box to set the items.

For Scope Mode

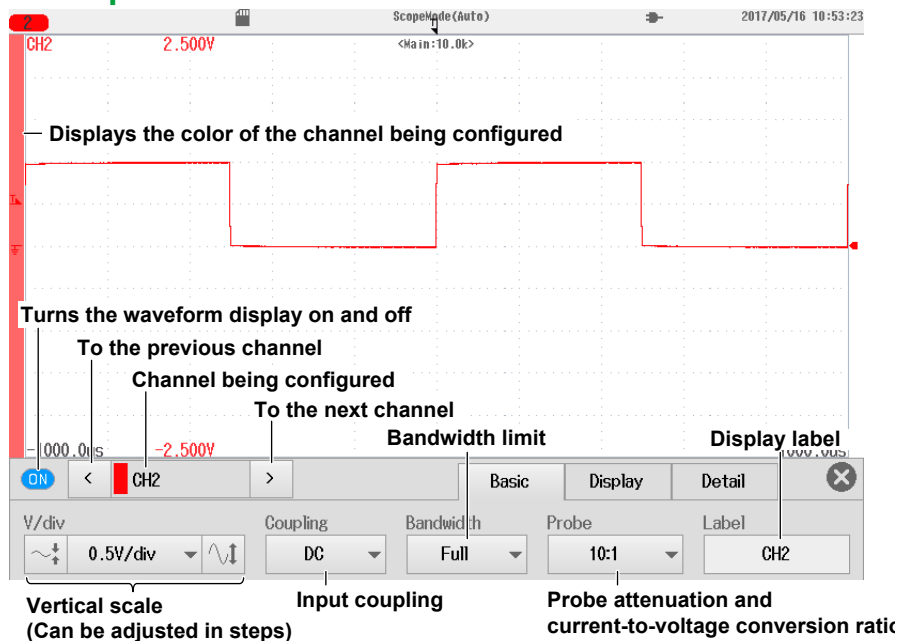

For Recorder Mode

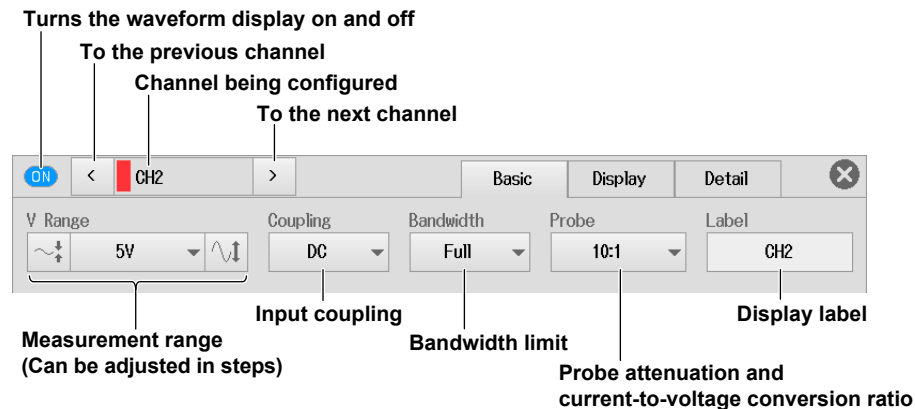

Input Coupling (Coupling)

The following figure shows the frequency characteristics when the input coupling is set to AC or DC. Note that if the input coupling is set to AC, the instrument does not acquire low-frequency signals or signal components as indicated in the figure below.

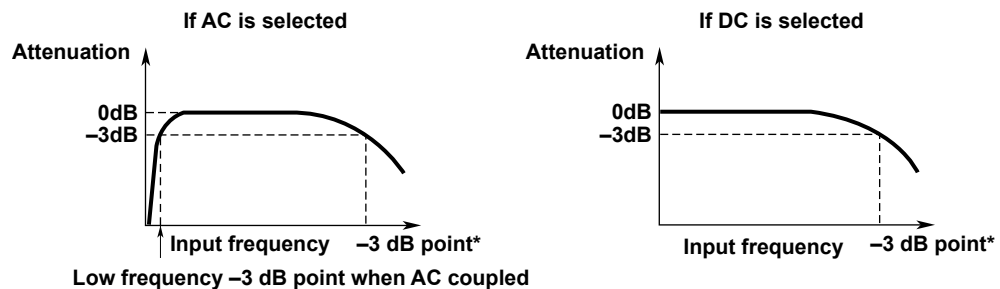

* This value differs depending on the input module.

For details, section 6.13, "Module Specifications," in the Getting Started Guide (IM DL350-03EN).



CAUTION

If the input coupling is AC, in accordance with the frequency response, the input signal is attenuated more in lower frequencies. As a result, even when a high voltage signal is actually applied, it may not be measured as a high voltage signal. Furthermore, the over-range indicator may not be displayed on the screen. As necessary, switch the input coupling to DC to check the input signal voltage.

Applying an input signal whose voltage exceeds the maximum input voltage of the input module may damage the input section.

French



ATTENTION

Si le courant du couplage d'entrée est alternatif (CA), conforme à la réponse en fréquence, le signal d'entrée est davantage atténué aux fréquences plus basses. Par conséquent, même si vous appliqué un signal de tension élevée, ce dernier risque de ne pas être mesuré comme tel. De plus, le voyant de dépassement de plage risque de ne pas s'afficher à l'écran. Le cas échéant, basculez le couplage d'entrée sur CC (courant continu) afin de vérifier la tension du signal d'entrée.

Si la tension du signal d'entrée dépasse la tension d'entrée maximale du module d'entrée, la section d'entrée risque d'être endommagée.

2.2 Configuring Voltage Measurements

Probe Attenuation and Current-to-Voltage Conversion Ratio (Probe)

1:1, 10:1, 100:1, 1000:1

The voltage probe attenuation is displayed.

1A:1V (1V/A), 10A:1V (0.1V/A), 100A:1V (0.01V/A), 400A:1V (2.5mV/A)

The current-to-voltage conversion ratio of the current probe is displayed.

Note

If the probe attenuation or current-to-voltage conversion ratio is not set correctly, the voltage and scale values of the input signals will not be displayed correctly. For example, if you use a 10:1 voltage probe but set the probe type to 1:1, the automatically measured amplitude of the waveform will be 1/10 the real value.

Configuring the Display (Display)

2. Tap the **Display** tab.
3. Tap each item. Use the displayed list (options) or input box to set the items.

For Scope Mode

When V Scale (vertical scale) Is Set to DIV

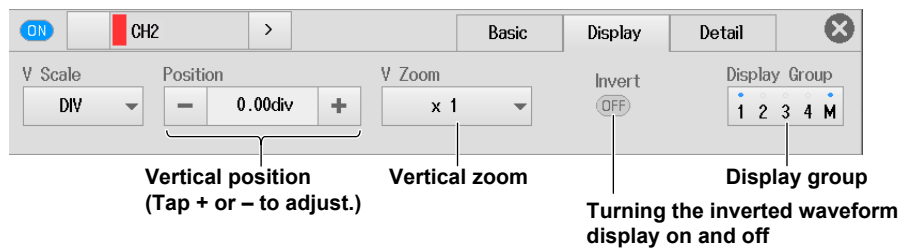

The vertical position can be moved also by tapping the up and down arrows that appear when you slide the waveform screen.
▶ See "Setting the Waveform Vertical and Horizontal Positions" (explained later).

When V Scale (vertical scale) Is Set to SPAN

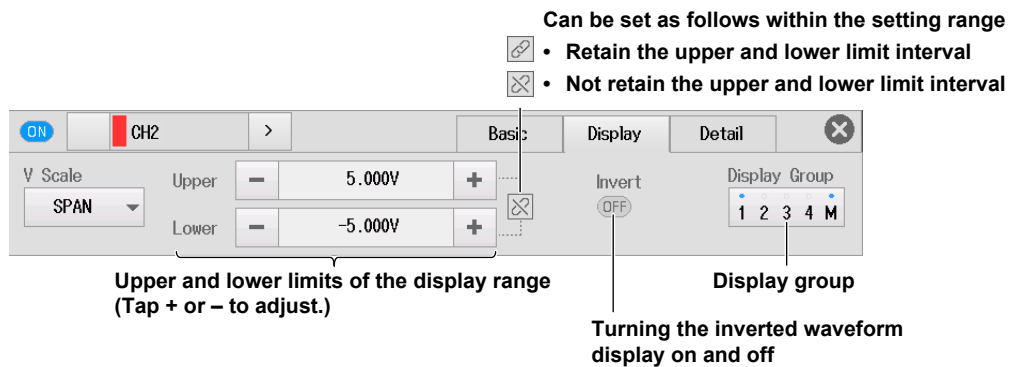

For Recorder Mode

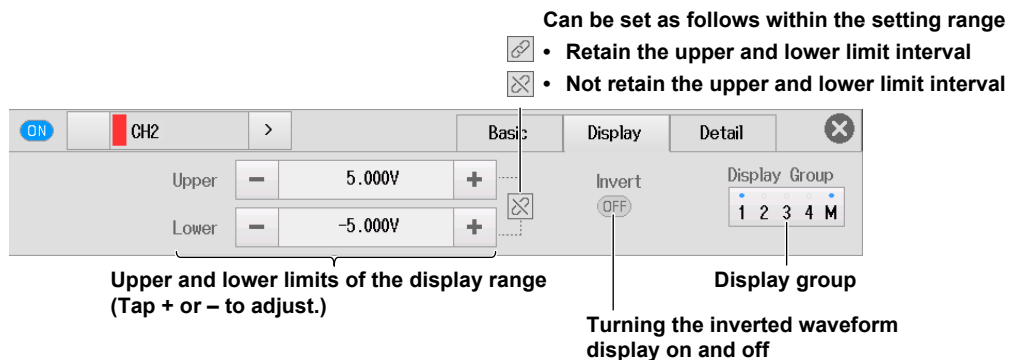

Detail Setting (Detail)

2. Tap the **Detail** tab.
3. Tap each item. Use the displayed list (options) or input box to set the items.

Items Common to Scope Mode and Recorder Mode

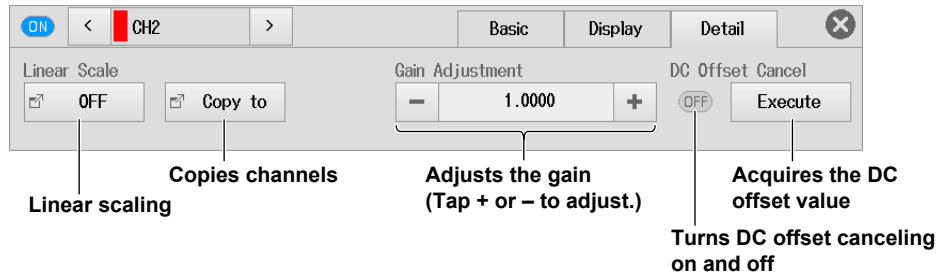

Note

- When DC offset cancellation is set to ON, you cannot adjust the gain.
- The gain adjustment is reset to 1.0000 when you execute DC offset cancellation or set it to on.

Linear Scaling (Linear Scale)

Tap **Linear Scale**. The following screen appears.

- **When the Scaling Mode Is Set to AX+B**

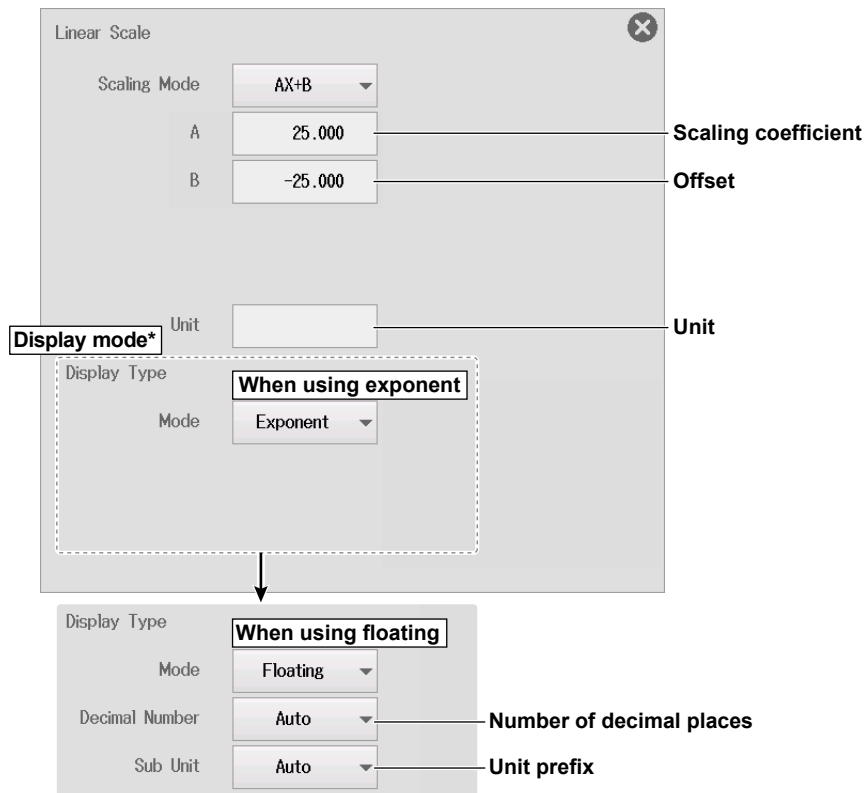

* Set these when measuring voltage with a voltage module or strain with a strain module.

2.2 Configuring Voltage Measurements

- **When the Scaling Mode Is Set to P1–P2**

Linear Scale

Scaling Mode: P1-P2

P1[X]: 1.0000

P1[Y]: 0.0000

P2[X]: 5.0000

P2[Y]: 100.00

Unit: []

Display mode*

Display Type: When using exponent

Mode: Exponent

Scale values

Measured values (tap Get Value or set using the input box)

Retrieves the current measured value

Unit

When using floating

Mode: Floating

Decimal Number: Auto

Sub Unit: Auto

Number of decimal places

Unit prefix

* Set these when measuring voltage with a voltage module or strain with a strain module.

- **When the Scaling Mode Is Set to Shunt**

Shunt mode is available for the strain module (701271 (STRAIN_DSUB)). This module has a built-in relay circuit for shunt calibration.

Linear Scale

Scaling Mode: Shunt

P1[X]: 1.0000

P1[Y]: 0.0000

P2[X]: 5.0000

P2[Y]: 100.00

Unit: []

Shunt Cal Exec

Display mode*

Display Type: When using exponent

Mode: Exponent

Current measured value when the relay circuit is off (tap Shunt Cal Exec or set using the input box)

Executes shunt calibration

Value for when the relay circuit is off (normally 0).

Current measured value when the relay circuit is on (tap Shunt Cal Exec or set using the input box)

Strain value corresponding to the shunt resistance when the relay circuit is on

Unit

When using floating

Mode: Floating

Decimal Number: Auto

Sub Unit: Auto

Number of decimal places

Unit prefix

Copying Channels (Copy to)

Tap **Copy to**. The following screen appears.

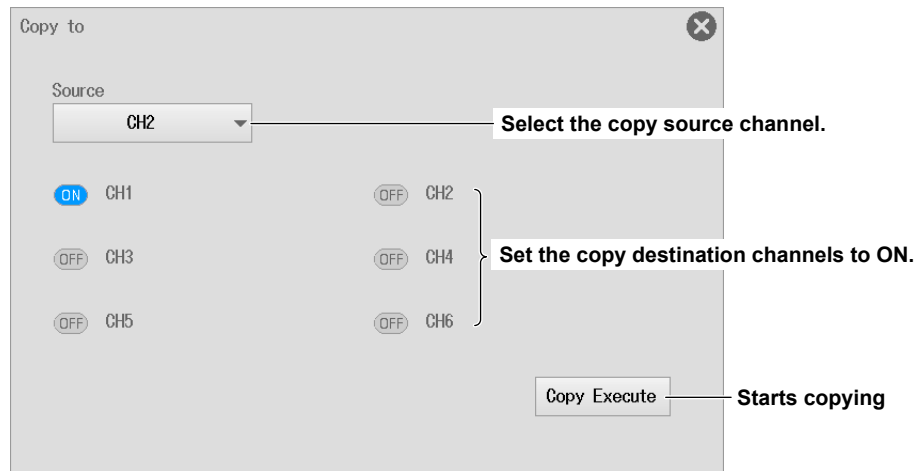

Setting the Waveform Vertical and Horizontal Positions (Sliding the waveform screen)

For Scope Mode

When you slide your finger across the waveform screen, up and down arrows appear. You can move the vertical position by performing the following operation while the arrows are displayed.

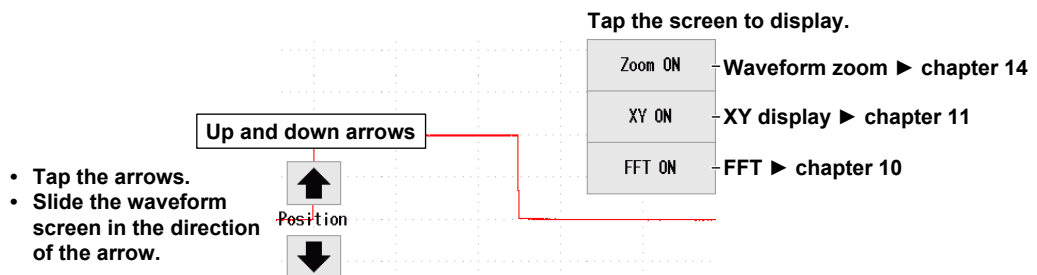

On the display setting screen of the channel setting menu described earlier, you can set the vertical position by entering a value.

For Recorder Mode

When you slide your finger across the waveform screen, up, down, left, and right arrows appear. You can move the vertical or horizontal position by performing the following operation while the arrows are displayed.

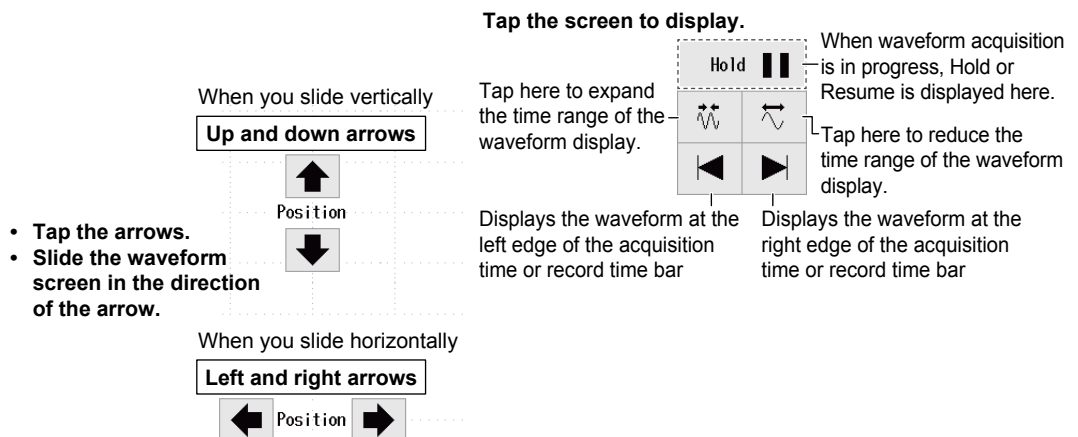

2.3 Configuring Voltage Measurements (For 16-CH voltage input modules)

This section explains the following settings for the 16-CH voltage input module:

For Scope Mode

- All sub channel settings
- Basic settings (waveform display on/off, vertical scale, input coupling, bandwidth limit, display labels)
- Display settings (vertical scale (zoom method), vertical position, vertical zoom (zooming by setting the magnification), zooming by setting the high limit and low limit of the display range, waveform inverted display on/off, display groups)
- Detail settings (linear scaling, channel copying)

For Recorder Mode

- All sub channel settings
- Basic settings (waveform display on/off, measurement range, input coupling, bandwidth limit, display labels)
- Display settings (high limit and low limit of the display range, waveform inverted display on/off, display groups)
- Detail settings (linear scaling, channel copying)

► [Features Guide: “Voltage Measurement \(For the 16-CH Voltage Input Module\)”](#)

Sub Channel Setting Menu

1. On the waveform screen, tap **MENU > Channel > CH1** or **CH3**. A sub channel setting menu appears.

You can also tap or double-tap a sub channel (if the display label is set to default, the channel number followed by an underscore and a number as in CH3_1) in the channel information area to display the sub channel setting menu.

(If the channel is selected, tap; otherwise, double-tap.)

Setting All Sub Channels (All Sub Channel Setup)

2. Tap the **Common** tab.

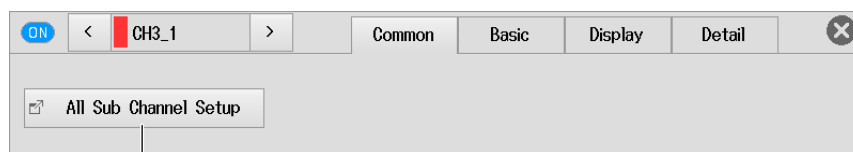

All sub channel settings

3. Tap **All Sub Channel Setup**. The All Sub Channel Setup screen appears.

Configuring Input Settings (Setup)

4. Tap the **Setup** tab. An input setting screen appears.
5. Tap the items of each sub channel. Use the displayed list (options) or input box to set the items. If you do not want to measure sub channels individually, set the input coupling to OFF.

2.3 Configuring Voltage Measurements (For 16-CH voltage input modules)

Example of an Input Setting Screen in Scope Mode

To set all the sub channels to the same setting, change the settings in the All row.

All Sub	Channel Setup	Input coupling		Vertical scale		Vertical position		
		Display label	Coupling	V/div	Bandwidth limit	DIV/SPAN	Position	V Zoom
All			DC	2V/div	Full	DIV	0.00div	x 1
1	CH3_1		DC	2V/div	Full	DIV	0.00div	x 1
2	CH3_2		DC	2V/div	Full	DIV	0.00div	x 1
3	CH3_3		DC	2V/div	Full	DIV	0.00div	x 1
4	CH3_4		DC	2V/div	Full	DIV	0.00div	x 1
5	CH3_5		DC	2V/div	Full	DIV	0.00div	x 1
6	CH3_6		DC	2V/div	Full	DIV	0.00div	x 1
7	CH3_7		DC	2V/div	Full	DIV	0.00div	x 1
8	CH3_8		DC	2V/div	Full	DIV	0.00div	x 1
9	CH3_9		DC	2V/div	Full	DIV	0.00div	x 1
10	CH3_10		DC	2V/div	Full	DIV	0.00div	x 1

When the vertical scale DIV is set to SPAN, Position and V Zoom change to Upper and Lower, respectively.

Example of an Input Setting Screen in Recorder Mode

To set all the sub channels to the same setting, change the settings in the All row.

All Sub	Channel Setup	Input coupling		Measurement range		Upper and lower limits of the display range	
		Display label	Coupling	V Range	Bandwidth limit	Upper	Lower
All			DC	20V	Full	25.000V	-25.000V
1	CH1_1		DC	20V	Full	25.000V	-25.000V
2	CH1_2		DC	20V	Full	25.000V	-25.000V
3	CH1_3		DC	20V	Full	25.000V	-25.000V
4	CH1_4		DC	20V	Full	25.000V	-25.000V
5	CH1_5		DC	20V	Full	25.000V	-25.000V
6	CH1_6		DC	20V	Full	25.000V	-25.000V
7	CH1_7		DC	20V	Full	25.000V	-25.000V
8	CH1_8		DC	20V	Full	25.000V	-25.000V
9	CH1_9		DC	20V	Full	25.000V	-25.000V
10	CH1_10		DC	20V	Full	25.000V	-25.000V

Linear Scaling (Linear Scale)

4. Tap the **Linear Scale** tab. The Linear Scale screen appears.
For details on the settings, see the explanation of linear scaling in section 2.2.
5. Tap the items of each sub channel. Use the displayed list (options) or input box to set the items.
To set all the sub channels to the same setting, change the settings in the All row.

Linear scaling mode

Scaling coefficient A or measured value at point P1

Offset value B or scaled value of point P1

Measurement value of point P2

Scaled value of point P2

Display mode

Number of decimal places

Unit

Unit prefix

All	Sub	Channel	Setup	Setup	Linear	Scale	(Channel Copy)	✕					
	Linear Scale	AX+B:A P1-P2	P1:X	AX+B:B P1-P2	P1:Y	P1-P2	P2:X	P1-P2	P2:Y	Unit	Disp Type	Decim Num	Sub Unit
All	OFF												
1	AX+B	25.000	-25.000								Float	Auto	k
2	P1-P2	1.0000	0.0000	5.0000	100.00						Exp		
3	OFF												
4	OFF												
5	OFF												
6	OFF												
7	OFF												
8	OFF												
9	OFF												
10	OFF												

↑↓ Slide to display channels that do not fit in the screen.

Copying Channels (Channel Copy)

4. Tap the **Channel Copy** tab. The Channel Copy screen appears.
5. Tap each item to set options from the displayed list or execute commands.

All Sub Channel Setup

Setup Linear Scale Channel Copy ✕

Source Sub Channel
CH3_1 — Select the copy sub source channel.

Destination Sub Channel

<input checked="" type="radio"/> ON	1	<input checked="" type="radio"/> ON	2	<input type="radio"/> OFF	3	<input type="radio"/> OFF	4
<input type="radio"/> OFF	5	<input checked="" type="radio"/> ON	6	<input checked="" type="radio"/> ON	7	<input type="radio"/> OFF	8
<input type="radio"/> OFF	9	<input type="radio"/> OFF	10	<input checked="" type="radio"/> ON	11	<input checked="" type="radio"/> ON	12
<input type="radio"/> OFF	13	<input type="radio"/> OFF	14	<input type="radio"/> OFF	15	<input type="radio"/> OFF	16

Set the copy destination sub channels to ON.

All ON — Sets all sub channel copy to ON.

All OFF — Sets all sub channel copy to OFF.

Copy Execute — Starts copying

Copying channels can also be set using **Copy to** on the **Detail** tab.

Basic Setup (Basic)

2. Tap the **Basic** tab.
3. Tap each item. Use the displayed list (options) or input box to set the items.

For Scope Mode

— Displays the color of the sub channel being configured

CH3_8 10.000V
 CH3_9 10.000V
 CH3_10 10.000V
 -250.0V
 -250.0V
 -10.000V

Waveform display on/off (all sub channels on/off)

To the previous main channel
 Sub channel being configured
 To the next main channel

ON < CH3_1 > Common Basic Display Detail

Sub Ch. V/div Coupling Bandwidth Label
 - 1 + 2V/div DC Full CH3_1

Vertical scale
 (Can be adjusted in steps)

Bandwidth limit

To the next sub channel
 Input coupling

Sub number of the sub channel
 being configured

To the previous sub channel

For Recorder Mode

Turns waveform display on and off (all sub channels on and off)

To the previous main channel
 Sub channel being configured
 To the next main channel

ON < CH3_1 > Common Basic Display Detail

Sub Ch. V Range Coupling Bandwidth Label
 - 1 + 20V DC Full CH3_1

Measurement range
 (Can be adjusted in steps)

Bandwidth limit

To the next sub channel
 Input coupling

Sub number of the sub channel
 being configured

To the previous sub channel

Input Coupling (Coupling)

Frequency characteristics when the input coupling is set to AC or DC and notes ► section 2.2
 If you do not want to measure sub channels individually, set the input coupling to OFF.

Configuring the Display (Display)

▶ section 2.2

For the sub channel settings (Sub Ch.), see “Basic Setup (Basic)” on the previous page.

Detail Setting (Detail)

▶ section 2.2

For the sub channel settings (Sub Ch.), see “Basic Setup (Basic)” on the previous page.

Linear Scaling (Linear Scale)

▶ section 2.2

Copying Channels (Copy to)

Tap **Copy to**. The following screen appears.

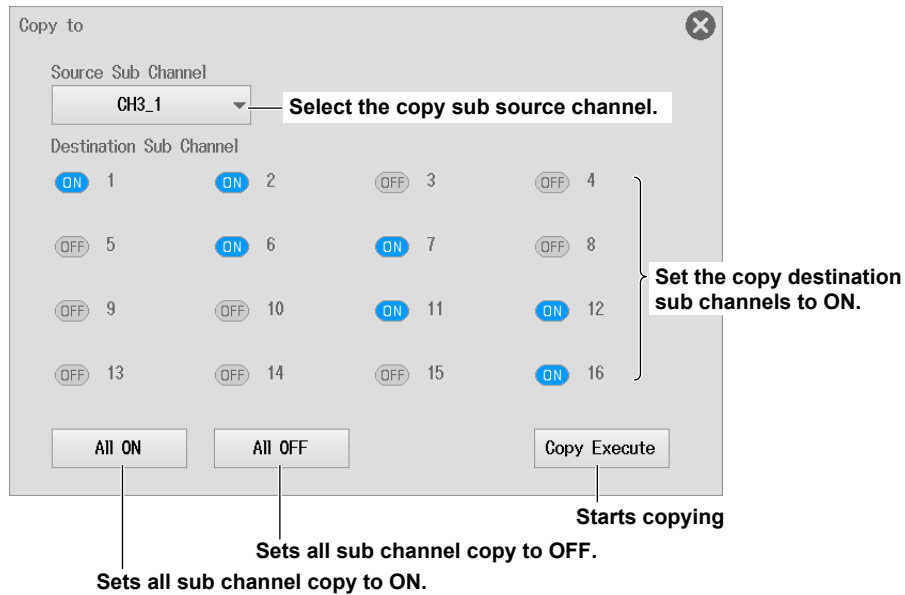

Copying channels can also be set using **Channel Copy** tab on the **All Sub Channel Setup** screen.

Setting the Waveform Vertical and Horizontal Positions (Sliding the waveform screen)

▶ section 2.2

2.4 Configuring Temperature Measurements

This section explains the following settings for temperature measurements:

Items Common to Scope Mode and Recorder Mode

- Basic settings (waveform display on/off, setting input coupling to TC, thermocouple type, bandwidth limit, RJC on/off, burnout on/off, display labels)
- Display settings (temperature unit, high limit and low limit of the display range, display groups)
- Detail settings (copying channels)

► [Features Guide: “Temperature Measurement”](#)

Channel Setting Menu

1. On the waveform screen, tap **MENU** > **Channel** > any channel from **CH1** to **CH4**. A channel setting menu appears.

You can also tap or double-tap any channel from CH1 to CH4 in the channel information area to display the channel setting menu.

(If the channel is selected, tap; otherwise, double-tap.)

Basic Setup (Basic)

2. Tap the **Basic** tab.
3. Tap each item. Use the displayed list (options) or input box to set the items.

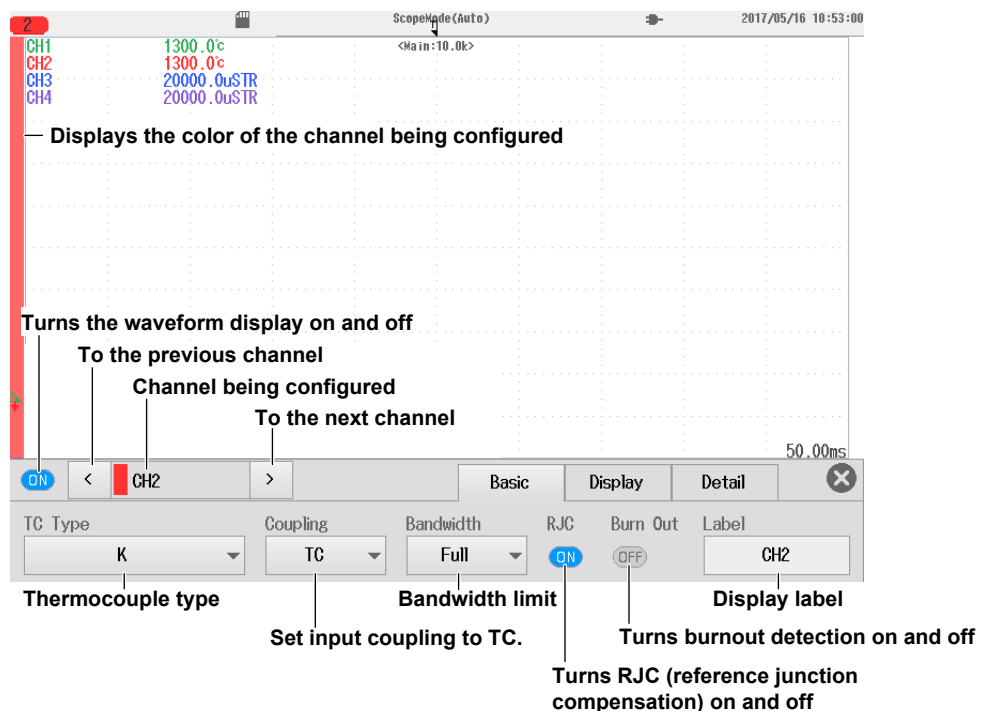

Input Coupling (Coupling)

To measure temperature, set the input coupling to TC.

To measure voltage, set the input coupling to an appropriate voltage measurement setting. ► [section 2.2](#)

Configuring the Display (Display)

2. Tap the **Display** tab.
3. Tap each item. Use the displayed list (options) or input box to set the items.

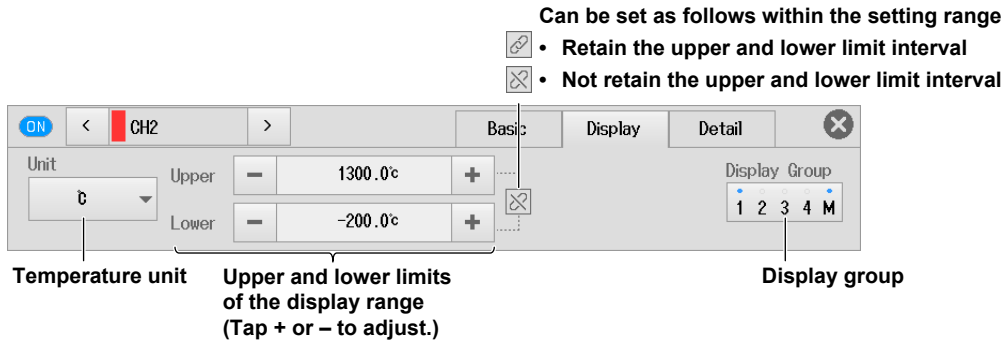

Detail Setting (Detail)

2. Tap the **Detail** tab.

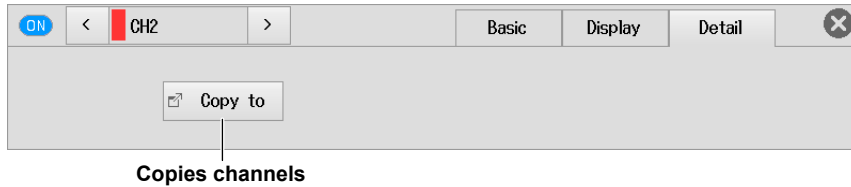

Copying Channels (Copy to)

- ▶ section 2.2

Setting the Waveform Vertical and Horizontal Positions (Sliding the waveform screen)

- ▶ section 2.2

2.5 Configuring Temperature Measurements (For 16-CH temperature/voltage input modules)

This section explains the following temperature measurement settings for the 16-CH temperature/voltage input module. For voltage measurement settings, see section 2.3.

Items Common to Scope Mode and Recorder Mode

- Data update period
- All sub channel settings
- Basic settings (waveform display on/off, setting input coupling to TC, thermocouple type, display labels, RJC on/off, burnout on/off)
- Display settings (temperature unit, high limit and low limit of the display range, waveform inverted display on/off, display groups)
- Detail settings (channel copying)

► [Features Guide: “Temperature Measurement \(For the 16-CH Temperature/Voltage Input Module\)”](#)

Sub Channel Setting Menu

1. On the waveform screen, tap **MENU > Channel > CH1** or **CH3**. A sub channel setting menu appears.

You can also tap or double-tap a sub channel (if the display label is set to default, the channel number followed by an underscore and a number as in CH3_1) in the channel information area to display the sub channel setting menu.

(If the channel is selected, tap; otherwise, double-tap.)

Setting the Data Update Period (Data Update Period) and Setting All Sub Channels (All Sub Channel Setup)

2. Tap the **Common** tab.

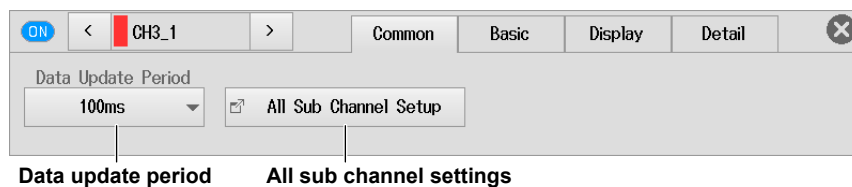

3. Tap **Data Update Period**. Use the displayed list (options) to set the data update period.
4. Tap **All Sub Channel Setup**. The All Sub Channel Setup screen appears.

Configuring Input Settings (Setup)

5. Tap the **Setup** tab. An input setting screen appears.
6. Tap the items of each sub channel. Use the displayed list (options) or input box to set the items.

Example of an Input Setting Screen in Scope Mode

- **When the Input Coupling Is Set to TC**

To set all the sub channels to the same setting, change the settings in the All row.

All Sub	Channel	Input coupling			Thermocouple type		Upper and lower limits of the display range		Turns RJC (reference junction compensation) on and off		Turns burnout detection on and off	
		Display label	Coupling	Type	Unit	Upper	Lower	RJC	Burn Out			
All	Sub	Setup										
		Setup	Linear Scale	Channel Copy								
		Label	Coupling	Type	Unit	Upper	Lower	RJC	Burn Out			
All			TC	K	°C	1300.0°C	-200.0°C	ON	OFF			
1	CH3_1		TC	K	°C	1300.0°C	-200.0°C	ON	OFF			
2	CH3_2		DC	0.2V/div	SPAN	20000.0mV	-20000.0mV					
3	CH3_3		DC	0.2V/div	SPAN	20000.0mV	-20000.0mV					
4	CH3_4		DC	0.2V/div	SPAN	20000.0mV	-20000.0mV					
5	CH3_5		DC	0.2V/div	SPAN	20000.0mV	-20000.0mV					
6	CH3_6		DC	0.2V/div	SPAN	20000.0mV	-20000.0mV					
7	CH3_7		DC	0.2V/div	SPAN	20000.0mV	-20000.0mV					
8	CH3_8		DC	0.2V/div	SPAN	20000.0mV	-20000.0mV					
9	CH3_9		DC	0.2V/div	SPAN	20000.0mV	-20000.0mV					
10	CH3_10		DC	0.2V/div	SPAN	20000.0mV	-20000.0mV					

Slide to display channels that do not fit in the screen.

- **When the Input Coupling Is Set to DC, GND, or OFF**

► section 2.3

For the 16-CH temperature/voltage input module, there is no bandwidth limit setting.

Example of an Input Setting Screen in Recorder Mode

- **When the Input Coupling Is Set to TC**

To set all the sub channels to the same setting, change the settings in the All row.

	Label	Coupling	Type	Unit	Upper	Lower	RJC	Burn Out
All		TC	K	°C	1300.0°C	-200.0°C	ON	OFF
1	CH3_1	TC	K	°C	1300.0°C	-200.0°C	ON	OFF
2	CH3_2	DC	2V		20000.0mV	-20000.0mV		
3	CH3_3	DC	2V		20000.0mV	-20000.0mV		
4	CH3_4	DC	2V		20000.0mV	-20000.0mV		
5	CH3_5	DC	2V		20000.0mV	-20000.0mV		
6	CH3_6	DC	2V		20000.0mV	-20000.0mV		
7	CH3_7	DC	2V		20000.0mV	-20000.0mV		
8	CH3_8	DC	2V		20000.0mV	-20000.0mV		
9	CH3_9	DC	2V		20000.0mV	-20000.0mV		
10	CH3_10	DC	2V		20000.0mV	-20000.0mV		

- **When the Input Coupling Is Set to DC, GND, or OFF**

► section 2.3

For the 16-CH temperature/voltage input module, there is no bandwidth limit setting.

Linear Scaling (Linear Scale)

You can set linear scaling on sub channels with the input coupling set to DC, GND, or OFF.

5. Tap the **Linear Scale** tab. The Linear Scale screen appears.
For details on the settings, see the explanation of linear scaling in section 2.2.
6. Tap the items of each sub channel. Use the displayed list (options) or input box to set the items.

Linear Scaling Screen

► section 2.3

Copying Channels (Channel Copy)

5. Tap the **Channel Copy** tab. The Channel Copy screen appears.
6. Tap each item to set options from the displayed list or execute commands.

Channel Copy Screen

► section 2.3

Copying channels can also be set using **Copy to** on the **Detail** tab.

Basic Setup (Basic)

2. Tap the **Basic** tab.
3. Tap each item. Use the displayed list (options) or input box to set the items.

When the Input Coupling Is Set to TC

Displays the color of the sub channel being configured

Turns waveform display on and off (all sub channels on and off)

To the previous main channel

Sub channel being configured

To the next main channel

ON < CH3_1 > Common Basic Display Detail

Sub Ch.	TC Type	Coupling	Label	RJC	Burn Out
- 1 +	K	TC	CH3_1	ON	OFF

Thermocouple type

Display label

Turns burnout detection on and off

Turns RJC (reference junction compensation) on and off

To the next sub channel

Sub number of the sub channel being configured

To the previous sub channel

Set input coupling to TC.

When the Input Coupling Is Set to DC, GND, or OFF

► section 2.3

For the 16-CH temperature/voltage input module, there is no bandwidth limit setting.

Configuring the Display (Display)

When the Input Coupling Is Set to TC

- ▶ section 2.4

For the sub channel settings (Sub Ch.), see “Basic Setup (Basic)” on the previous page.

When the Input Coupling Is Set to DC, GND, or OFF

- ▶ section 2.2

For the sub channel settings (Sub Ch.), see “Basic Setup (Basic)” on the previous page.

Detail Setting (Detail)

- ▶ section 2.2

For the 16-CH temperature/voltage input module, there is no gain adjustment or DC offset cancellation setting.

For the sub channel settings, see “Basic Setup (Basic)” on the previous page.

Linear Scaling (Linear Scale)

You can set linear scaling on sub channels with the input coupling set to DC, GND, or OFF.

- ▶ section 2.2

Copying Channels (Copy to)

- ▶ section 2.3

Copying channels can also be set using **Channel Copy** tab on the **All Sub Channel Setup** screen.

Setting the Waveform Vertical and Horizontal Positions (Sliding the waveform screen)

- ▶ section 2.2

2.6 Configuring Strain Measurements

This section explains the following settings for strain measurements:

Items Common to Scope Mode and Recorder Mode

- Basic settings (waveform display on/off, measurement range, bandwidth limit, display labels, sensor settings, strain balancing)
- Display settings (range unit, high limit and low limit of the display range, waveform inverted display on/off, display groups)
- Detail settings (linear scaling, channel copying)

► [Features Guide: “Strain Measurement”](#)

Channel Setting Menu

1. On the waveform screen, tap **MENU > Channel >** any channel from **CH1 to CH4**. A channel setting menu appears.
You can also tap or double-tap any channel from CH1 to CH4 in the channel information area to display the channel setting menu.
(If the channel is selected, tap; otherwise, double-tap.)

Basic Setup (Basic)

2. Tap the **Basic** tab.
3. Tap each item. Use the displayed list (options) or input box to set the items.

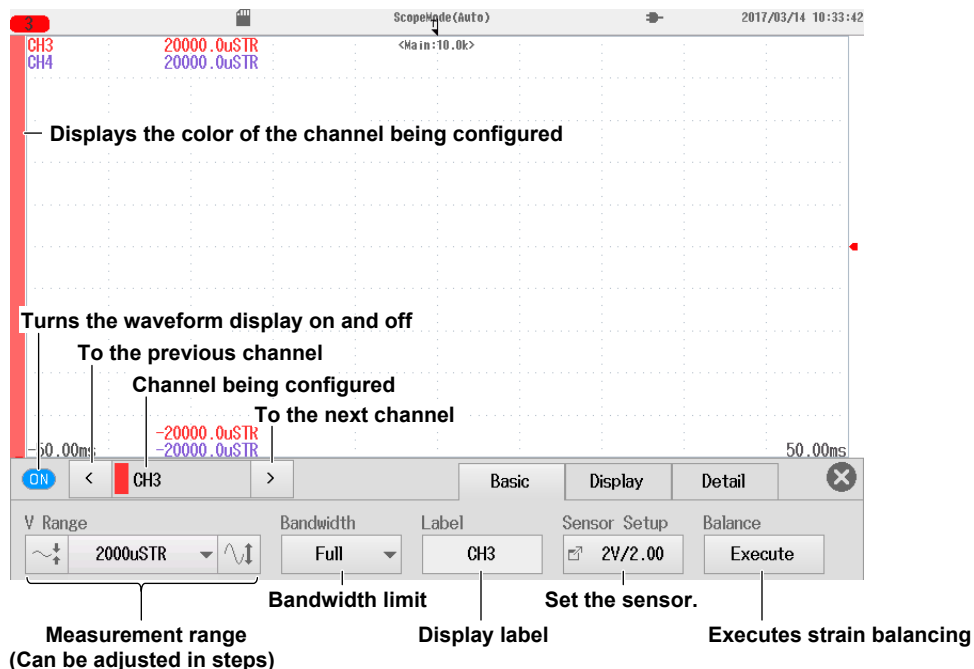

Configuring the Sensor (Sensor Setup)

4. Tap **Sensor Setup**. The following screen appears.



Bridge voltage

Gauge factor
(Tap + or – to adjust.)

Configuring the Display (Display)

2. Tap the **Display** tab.

3. Tap each item. Use the displayed list (options) or input box to set the items.

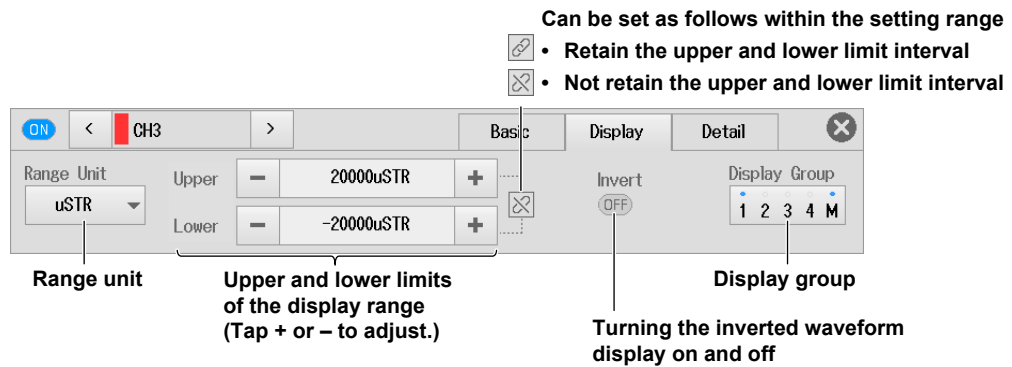

Can be set as follows within the setting range

- Retain the upper and lower limit interval
- Not retain the upper and lower limit interval

Range unit

Upper and lower limits
of the display range
(Tap + or – to adjust.)

Turning the inverted waveform
display on and off

Range Unit (Range Unit)

- μSTR : Units of strain ($\times 10^{-6}$ strain)
- mV/V: Units of strain-gauge-transducer output
The mV/V range is calculated from the following equation.
$$\text{mV/V} = 0.5 \times (\mu\text{STR}/1000)$$

Detail Setting (Detail)

► section 2.2

For the strain module, there is no gain adjustment or DC offset cancellation setting.

Linear Scaling (Linear Scale)

► section 2.2

Copying Channels (Copy to)

► section 2.2

Setting the Waveform Vertical and Horizontal Positions (Sliding the waveform screen)

► section 2.2

2.7 Configuring Acceleration Measurements

This section explains the following settings for acceleration measurements:

For Scope Mode

- Basic settings (waveform display on/off, gain, setting the input coupling to ACCEL, bandwidth limit, bias current supply to the acceleration sensor on and off, display labels)
- Display settings (vertical scale (zoom method), vertical position, vertical zoom (zooming by setting the magnification), zooming by setting the high limit and low limit of the display range, unit of acceleration, display groups)
- Detail settings (copying channels, acceleration sensor sensitivity)

For Recorder Mode

- Basic settings (waveform display on/off, gain, setting the input coupling to ACCEL, bandwidth limit, bias current supply to the acceleration sensor on and off, display labels)
- Display settings (high limit and low limit of the display range, unit of acceleration, display groups)
- Detail settings (copying channels, acceleration sensor sensitivity)

► [Features Guide: “Acceleration Measurement”](#)

Channel Setting Menu

1. On the waveform screen, tap **MENU** > **Channel** > any channel from **CH1** to **CH4**. A channel setting menu appears.
You can also tap or double-tap any channel from CH1 to CH4 in the channel information area to display the channel setting menu.
(If the channel is selected, tap; otherwise, double-tap.)

Basic Setup (Basic)

2. Tap the **Basic** tab.
3. Tap each item. Use the displayed list (options) or input box to set the items.

Items Common to Scope Mode and Recorder Mode

CH3
CH4

5000.000m/s²
250.00V

<Main:10.0k>

Displays the color of the channel being configured

Turns the waveform display on and off

To the previous channel
Channel being configured
To the next channel

ON < CH3 > Basic Display Detail

Gain x 1 Coupling ACCEL Bandwidth Full Bias OFF Label CH3

Gain (Can be adjusted in steps) Bandwidth limit Bias current supply to the acceleration sensor on and off Display label

Set Coupling to ACCEL.

Input Coupling (Coupling)

To measure acceleration, set the input coupling to ACCEL.

To measure voltage, set the input coupling to an appropriate voltage measurement setting.

► section 2.2

Configuring the Display (Display)

2. Tap the **Display** tab.
3. Tap each item. Use the displayed list (options) or input box to set the items.

For Scope Mode

When V Scale (vertical scale) Is Set to DIV

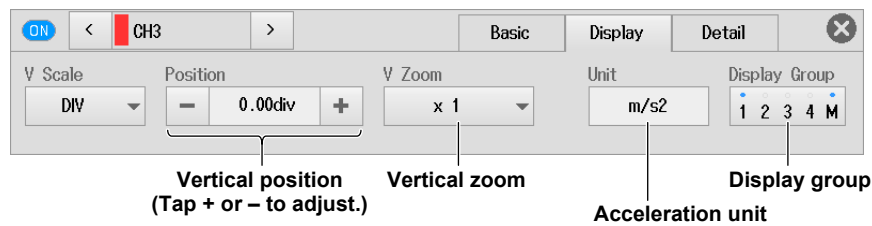

The vertical position can be moved also by tapping the up and down arrows that appear when you slide the waveform screen.

► section 2.2

When V Scale (vertical scale) Is Set to SPAN

Can be set as follows within the setting range

- Retain the upper and lower limit interval
- Not retain the upper and lower limit interval

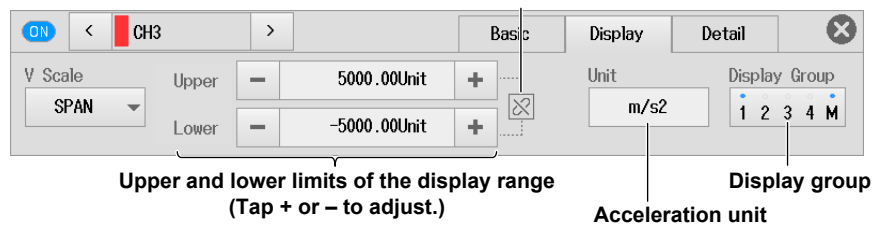

For Recorder Mode

Can be set as follows within the setting range

- Retain the upper and lower limit interval
- Not retain the upper and lower limit interval

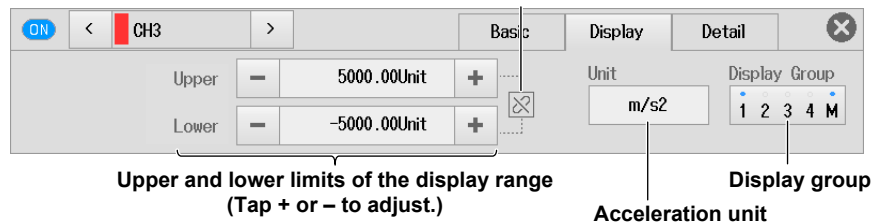

Detail Setting (Detail)

2. Tap the **Detail** tab.
3. Tap each item. Use the displayed list (options) or input box to set the items.

Items Common to Scope Mode and Recorder Mode

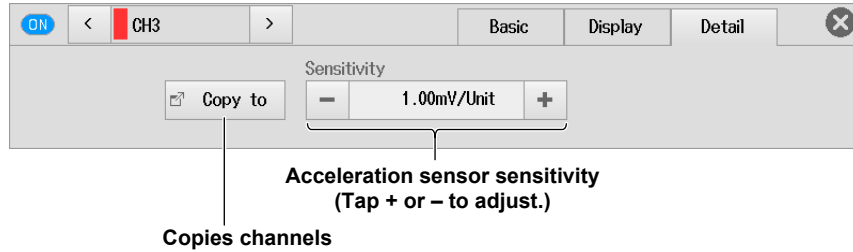

Copying Channels (Copy to)

- ▶ section 2.2

Setting the Waveform Vertical and Horizontal Positions (Sliding the waveform screen)

- ▶ section 2.2

2.8 Configuring Frequency, Revolution, Period, Duty Cycle, Power Supply Frequency, Pulse Width, Pulse Integration, and Velocity Measurements

This section explains the following settings for frequency, revolution, period, duty cycle, power supply frequency, pulse width, pulse integration, and velocity measurements:

For Scope Mode

- Basic settings (waveform display on/off, vertical scale, FV setup (measurement item), display labels, input setup)
- Display settings (vertical scale (zoom method), vertical position, vertical zoom (zooming by setting the magnification), zooming by setting the high limit and low limit of the display range, display groups)
- Detail settings (linear scaling, channel copying)

For Recorder Mode

- Basic settings (waveform display on/off, measurement range, FV setup (measurement item), display labels, input setup)
- Display settings (high limit and low limit of the display range, display groups)
- Detail settings (linear scaling, channel copying)

► [Features Guide: “Frequency Measurement”](#)

Channel Setting Menu

1. On the waveform screen, tap **MENU** > **Channel** > any channel from **CH1** to **CH4**. A channel setting menu appears.
You can also tap or double-tap any channel from CH1 to CH4 in the channel information area to display the channel setting menu.
(If the channel is selected, tap; otherwise, double-tap.)

Basic Setup (Basic)

2. Tap the **Basic** tab.
3. Tap each item. Use the displayed list (options) or input box to set the items.

For Scope Mode

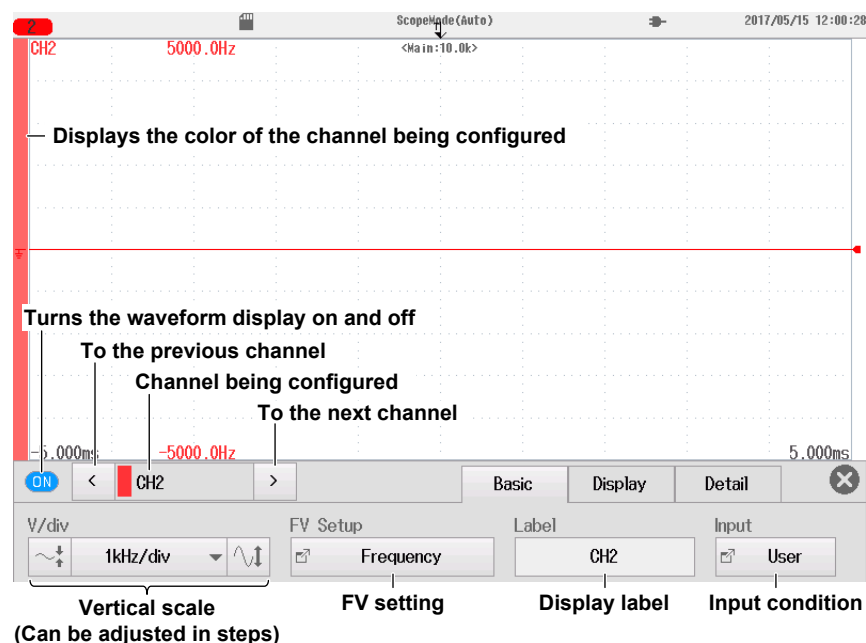

For Recorder Mode



FV Setup (FV Setup)

4. Tap **FV Setup**. The following screen appears.
5. Tap each item. Use the displayed list (options) or input box to set the items.

- **When the measurement item is Frequency**

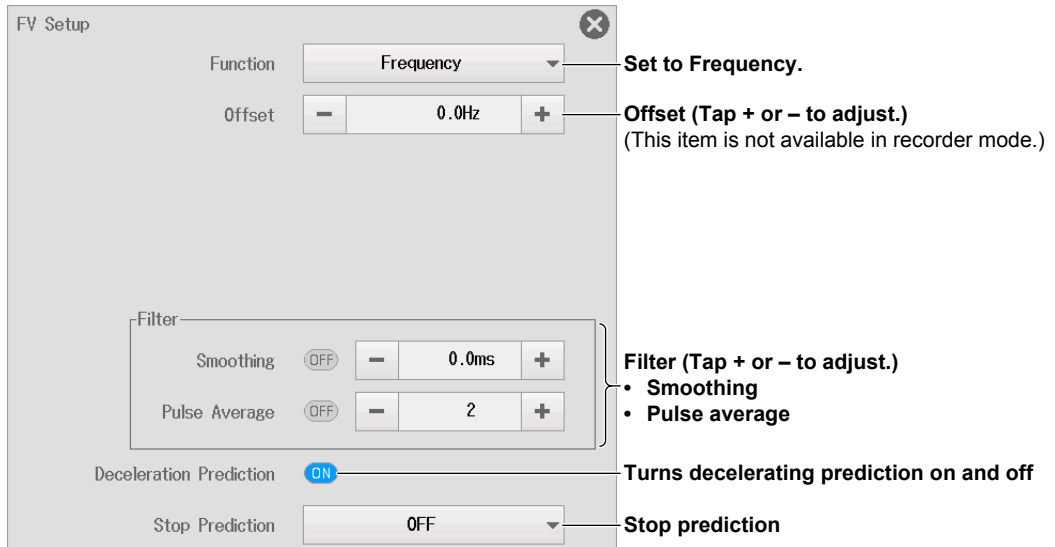

- **When the measurement item is Revolution (rpm)**

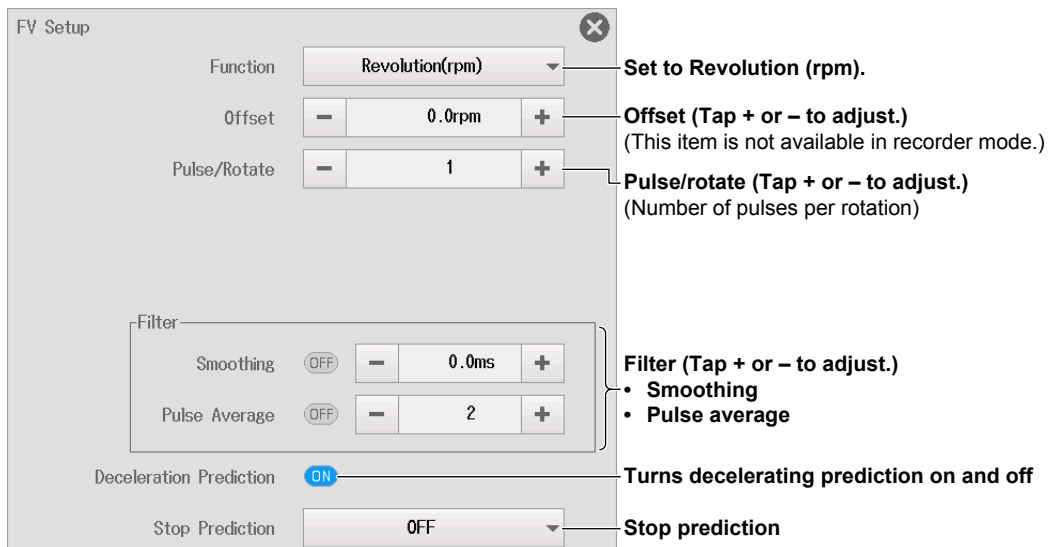

• When the measurement item is Revolution (rps)

Function **Set to Revolution (rps).**

Offset **Offset (Tap + or – to adjust.)**
(This item is not available in recorder mode.)

Pulse/Rotate **Pulse/rotate (Tap + or – to adjust.)**
(Number of pulses per rotation)

Filter (Tap + or – to adjust.)

- Smoothing** **Smoothing**
- Pulse Average** **Pulse average**

Deceleration Prediction **Turns decelerating prediction on and off**

Stop Prediction **Stop prediction**

• When the measurement item is Period

Function **Set to Period.**

Offset **Offset (Tap + or – to adjust.)**
(This item is not available in recorder mode.)

Filter (Tap + or – to adjust.)

- Smoothing** **Smoothing**
- Pulse Average** **Pulse average**

Deceleration Prediction **Turns decelerating prediction on and off**

Stop Prediction **Stop prediction**

• When the measurement item is Duty

The screenshot shows the 'FV Setup' dialog with the following settings:

- Function:** Duty (Set to Duty.)
- Offset:** 0.00% (Offset (Tap + or – to adjust.) (This item is not available in recorder mode.))
- Measure Pulse:** Positive (Measurement pulse selection)
- Filter:**
 - Smoothing: OFF (Filter (Tap + or – to adjust.) • Smoothing)
- TimeOut:** 10.00100s (Timeout period (Tap + or – to adjust.))

• When the measurement item is Power Freq

The screenshot shows the 'FV Setup' dialog with the following settings:

- Function:** Power Freq (Set Function to Power Freq.)
- Center Freq:** 50Hz (Center frequency)
- Filter:**
 - Smoothing: OFF (Filter (Tap + or – to adjust.) • Smoothing)
 - Pulse Average: 2 (Filter (Tap + or – to adjust.) • Pulse average)

• When the measurement item is Pulse Width

The screenshot shows the 'FV Setup' dialog with the following settings:

- Function:** Pulse Width (Set to Pulse Width.)
- Offset:** 0.0us (Offset (Tap + or – to adjust.) (This item is not available in recorder mode.))
- Measure Pulse:** Positive (Measurement pulse selection)
- Filter:**
 - Smoothing: OFF (Filter (Tap + or – to adjust.) • Smoothing)

• When the measurement item is Pulse Integ

Function **Set to Pulse Integ.**

Offset **Offset (Tap + or – to adjust.)**
(This item is not available in recorder mode.)

Unit/Pulse **Unit/pulse (Physical amount per pulse)**

Unit **Pulse integration unit**

Filter

Smoothing OFF **Filter (Tap + or – to adjust.)**

Pulse Average OFF **Filter (Tap + or – to adjust.)**

- Smoothing
- Pulse average

Over Limit Reset OFF **Turns auto reset at pulse count overflow on and off**

Reset **Executes the manual reset of the pulse count**

• When the measurement item is Velocity

Function **Set to Velocity.**

Offset **Offset (Tap + or – to adjust.)**
(This item is not available in recorder mode.)

Distance/Pulse **Distance/pulse (Distance per pulse)**

Time Unit **Time unit**

Unit **Velocity unit**

Filter

Smoothing OFF **Filter (Tap + or – to adjust.)**

Pulse Average OFF **Filter (Tap + or – to adjust.)**

- Smoothing
- Pulse average

Deceleration Prediction ON **Turns decelerating prediction on and off**

Stop Prediction **Stop prediction**

Input Setup (Input Setup)

4. Tap **Input**. The following screen appears.
5. Tap each item. Use the displayed list (options) or input box to set the items.

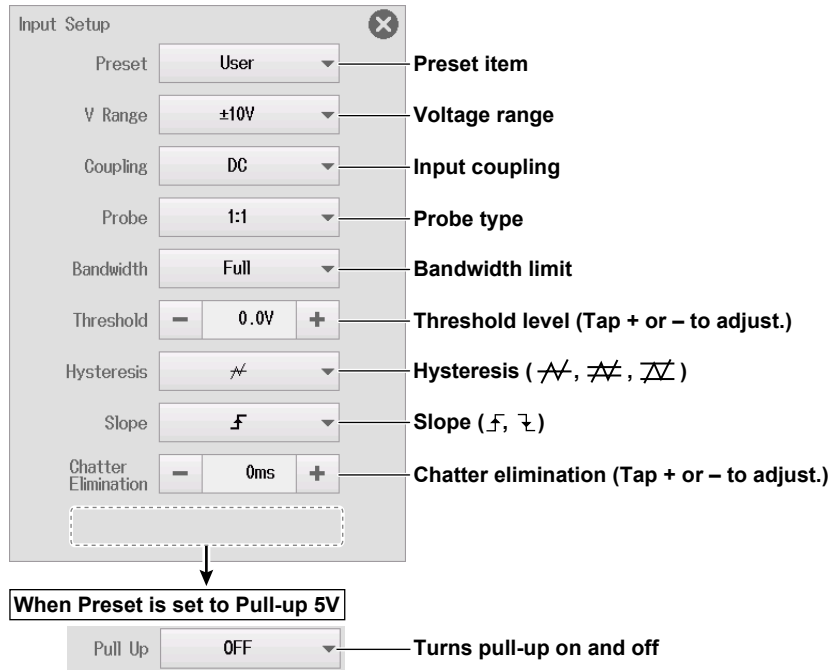

Setting Preset Items

You can set the preset to one of the following 10 options: Logic 5V, Logic 3V, Logic 12V, Logic 24V, Pull-up 5V, ZeroCross, AC100V, AC200V, EM Pickup, or User (user-defined).

The settable input items differ depending on the preset that you set. You can only turn pull-up on and off when the preset is set to Pull-up 5V.

Configuring the Display (Display)

For Scope Mode

- ▶ section 2.2
- There are no inverted waveform display items.
- If the FV setup measurement item is Power Freq, V Scale is fixed to DIV, so no options will appear.
- If the FV setup measurement item is Pulse Integ or Velocity, the setting for retaining the upper and lower limit interval for when V Scale is set to SPAN is not available.

For Recorder Mode

- ▶ section 2.2
- There are no inverted waveform display items.
- If the FV setup measurement item is Power Freq, the same vertical position and vertical zoom menu as scope mode is displayed.
- If the FV setup measurement item is Pulse Integ or Velocity, the setting for retaining the upper and lower limit interval is not available.

Detail Settings (Detail)

Items Common to Scope Mode and Recorder Mode

- ▶ section 2.2
- There are no gain adjustment and DC offset items.
- The linear scaling setting menu does not have the display mode item.

Setting the Waveform Vertical and Horizontal Positions (Sliding the waveform screen)

- ▶ section 2.2

2.9 Configuring Logic Signal Measurements

This section explains the following settings for logic measurements:

Items Common to Scope Mode and Recorder Mode

- Basic settings (waveform display on/off, display labels, bit settings, copying channels)
- Display settings (vertical position, vertical zoom (zooming by setting the magnification), bit mapping, display groups)

► [Features Guide: “Logic Measurement”](#)

Channel Setting Menu

1. On the waveform screen, tap **MENU** > **Channel** > any channel from **CH1** to **CH6**. A channel setting menu appears.
You can also tap or double-tap any channel from CH1 to CH6 in the channel information area to display the channel setting menu.
(If the channel is selected, tap; otherwise, double-tap.)

Basic Setup (Basic)

2. Tap the **Basic** tab.
3. Tap each item. Use the displayed list (options) or input box to set the items.

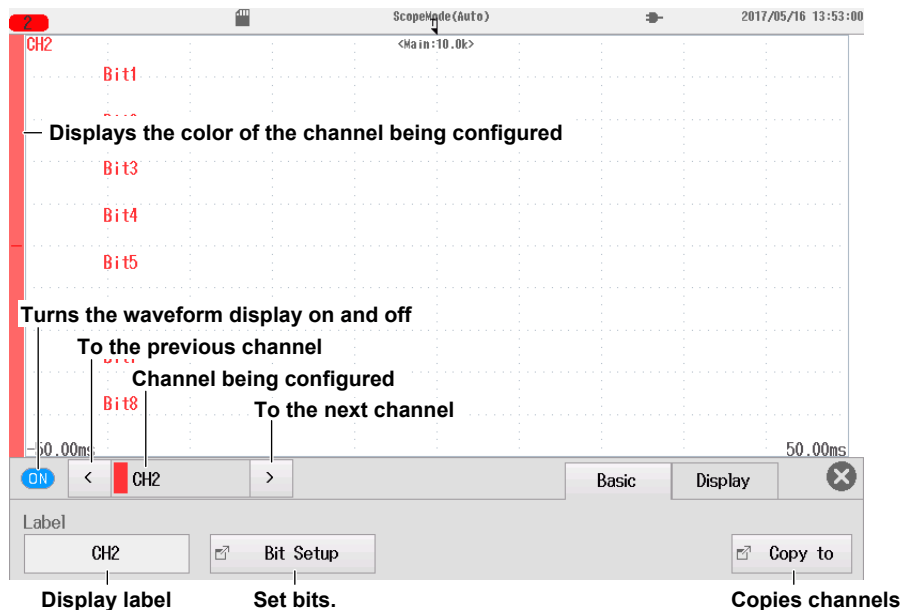

Bit Settings (Bit Setup)

4. Tap **Bit Setup**. The following screen appears.
5. Tap each item. Use the displayed list (options) or input box to set the items.

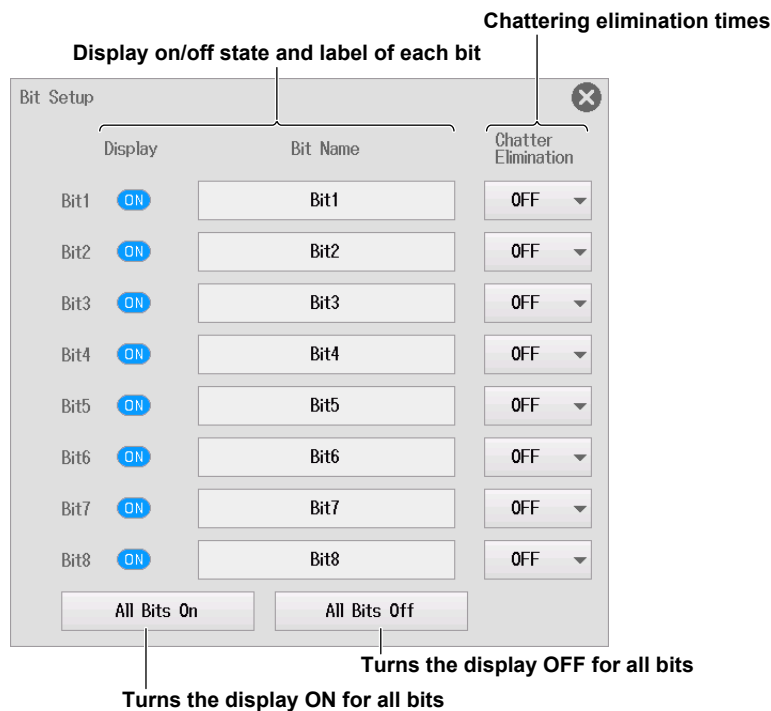

Copying Channels (Copy to)

- ▶ section 2.2

Configuring the Display (Display)

2. Tap the **Display** tab.
3. Tap each item. Use the displayed list (options) or input box to set the items.

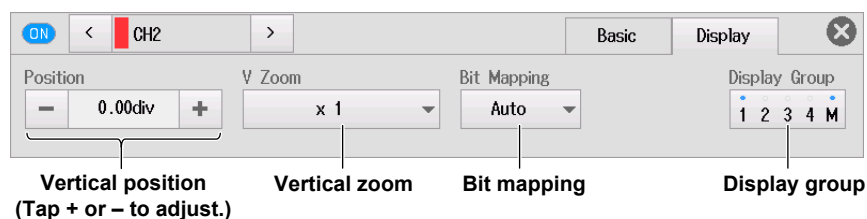

Setting the Waveform Vertical and Horizontal Positions (Sliding the waveform screen)

- ▶ section 2.2

2.10 Configuring the Monitoring of CAN and CAN FD Bus Signals (/VE option)

This section explains the following settings for monitoring CAN and CAN FD bus signals:

Items Common to Scope Mode and Recorder Mode

- CAN port configuration (waveform display on/off, port and all sub channel settings, loading CAN/CAN FD data definition files, scaling all sub channels)
- Display settings (display range of each sub channel, scaling each sub channel, vertical position of each sub channel, vertical zoom of each sub channel (zooming by setting the magnification), display groups)
- One shot output

► [Features Guide: “CAN and CAN FD Bus Signal Monitoring”](#)

Channel Setting Menu

1. On the waveform screen, tap **MENU > Channel >** any channel from **CH1 to CH4**. A channel setting menu appears.
You can also tap or double-tap any channel from CH1 to CH4 in the channel information area to display the channel setting menu.
(If the channel is selected, tap; otherwise, double-tap.)

CAN Port Configuration (CAN Port Config)

2. Tap the **CAN Port Config.** tab.
3. Tap each item to set options and execute commands.

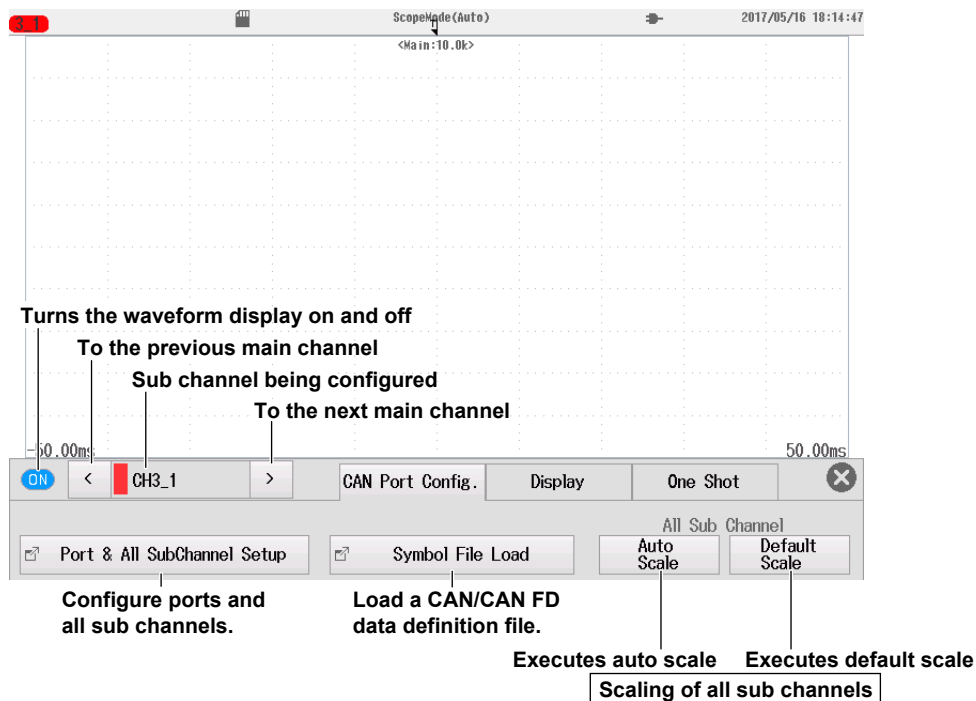

Port and All Sub Channel Settings (Port & All SubChannel Setup)

4. Tap **Port & All SubChannel Setup**. A Port & All SubChannel Setup screen appears.

All Sub Channel Setup (All SubChannel Setup - CAN or CAN FD Data Extraction Conditions)

5. Tap the **All SubChannel Setup** tab. The following screen appears.
6. Tap each item. Use the displayed list (options) or input box to set the items.

Turns the sub channel monitoring on and off

To set all the sub channels to the same setting, change the settings in the All row.

CAN or CAN FD data extraction conditions

Port & All SubChannel Setup		All SubChannel Setup	All SubChannel Factor/Offset	Port Setup					
	Input	Label	Msg Fmt	ID(Hex)	Byte Count	Start Bit	Bit Cnt	Byte Order	Value Type
All	<input type="radio"/>								
1	<input type="radio"/>	CH3_1	STD	0x000	Auto	0	8	Big	Unsigned
2	<input type="radio"/>	CH3_2	STD	0x000	Auto	0	8	Big	Signed
3	<input type="radio"/>	CH3_3	STD	0x000	Auto	0	32	Big	Float
4	<input type="radio"/>	CH3_4	STD	0x000	Auto	0	8	Big	Logic
5	<input type="radio"/>	CH3_5	STD	0x000	Auto	0	8	Big	Unsigned
6	<input type="radio"/>	CH3_6	STD	0x000	Auto	0	8	Big	Unsigned
7	<input type="radio"/>	CH3_7	STD	0x000	Auto	0	8	Big	Unsigned
8	<input type="radio"/>	CH3_8	STD	0x000	Auto	0	8	Big	Unsigned
9	<input type="radio"/>	CH3_9	STD	0x000	Auto	0	8	Big	Unsigned
10	<input type="radio"/>	CH3_10	STD	0x000	Auto	0	8	Big	Unsigned

Slide to display channels that do not fit in the screen.

All Sub Channel Factor/Offset (All SubChannel Factor/Offset - CAN or CAN FD Data Conversion Condition)

5. Tap the **All SubChannel Factor/Offset** tab. The following screen appears.
6. Tap each item. Use the displayed input box to set the items.

CAN or CAN FD data conversion conditions

Port & All SubChannel Setup			All SubChannel Setup	All SubChannel Factor/Offset	Port Setup	
	Input	Label	Factor	Offset	Unit	
All	<input type="radio"/>					
1	<input type="radio"/>	CH3_1	1.0000	0.0000		
2	<input type="radio"/>	CH3_2	1.0000	0.0000		
3	<input type="radio"/>	CH3_3	1.0000	0.0000		
4	<input type="radio"/>	CH3_4	*	*	*	
5	<input type="radio"/>	CH3_5	1.0000	0.0000		
6	<input type="radio"/>	CH3_6	1.			
7	<input type="radio"/>	CH3_7	1.0000	0.0000		
8	<input type="radio"/>	CH3_8	1.0000	0.0000		
9	<input type="radio"/>	CH3_9	1.0000	0.0000		
10	<input type="radio"/>	CH3_10	1.0000	0.0000		

Slide to display channels that do not fit in the screen.

* You cannot set Factor, Offset, or Unit when the data type (Value Type) is set to Logic.

2.10 Configuring the Monitoring of CAN and CAN FD Bus Signals (/VE option)

Port Settings (Port Setup)

5. Tap the **Port Setup** tab. The following screen appears.

6. Tap each item. Use the displayed list (options) or input box to set the items.

- **CAN Bus Signal Monitoring (for the 720240 (CAN MONITOR), 720241 (CAN & LIN) modules)**

The screenshot shows the 'Port Setup' screen for CAN Bus Signal Monitoring. The screen has a title bar with 'Port & All SubChannel Setup' and two tabs: 'All SubChannel Setup' and 'Port Setup'. The 'Port Setup' tab is active. The settings are as follows:

- Bit Rate: 500Kbps (dropdown menu) — **Bit rate**
- Sample Point: 85% (dropdown menu) — **Sample point**
- Sync Jump Width: - 2 + (input field with minus and plus buttons) — **Resynchronization jump width (Tap + or - to adjust.)**
- Bit Sample Num: 1 (dropdown menu) — **Sample count**
- Listen Only: OFF (toggle switch) — **Turns listen-only on and off**
- Terminator: OFF (toggle switch) — **Turns the terminator on and off**

- **CAN and CAN FD Bus Signal Monitoring (for the 720242 (CAN/CAN FD) module)**

The screenshot shows the 'Port Setup' screen for CAN and CAN FD Bus Signal Monitoring. The screen has a title bar with 'Port & All SubChannel Setup' and two tabs: 'All SubChannel Setup' and 'Port Setup'. The 'Port Setup' tab is active. The settings are as follows:

- Bit Rate: 500Kbps (dropdown menu) — **Bit rate**
- Sample Point: - 85 + (input field with minus and plus buttons) — **Sample point**
- CAN FD section (enclosed in a box):
 - FD Standard: ISO (dropdown menu) — **CAN FD standard**
 - Data Bit Rate: 1Mbps (dropdown menu) — **Data bit rate**
 - Data Sample Point: - 85 + (input field with minus and plus buttons) — **Data sample point**
- Listen Only: OFF (toggle switch) — **Turns listen-only on and off**
- Terminator: OFF (toggle switch) — **Turns the terminator on and off**

Loading a CAN/CAN FD Data Definition File (Symbol File Load)

4. Tap **Symbol File Load**. A file list appears.
5. On the file list, tap a symbol file (SBL file).
For details on file list operations, see section 6.10.
6. Select the load destination channel.
▶ section 6.9
7. Tap **Load**. A confirmation message appears.
8. Tap **OK**. The symbol file is loaded.

Sub Channel Display Settings (Display)

2. Tap the **Display** tab.
3. Tap each item. Use the displayed list (options) or input box to set the items.

When the Data Type (Value Type) Is Unsigned, Signed, or Float

The screenshot shows the 'Display' configuration screen for channel CH3_1. It features a 'Sub Channel' selector set to 1, 'Upper' and 'Lower' limit input fields with values 400.00 and -100.00 respectively, 'Auto Scale' and 'Default Scale' buttons, and a 'Display Group' selector with options 1, 2, 3, 4, and M. Brackets and text labels identify these elements: 'Specify the sub channel. (Tap + or - to change.)' points to the Sub Channel selector; 'Upper and lower limits of the display range' points to the Upper and Lower input fields; 'Executes auto scale' and 'Executes default scale' point to their respective buttons; and 'Scaling of the specified sub channel' is a box encompassing both the Auto Scale and Default Scale buttons. 'Display group' points to the Display Group selector.

When the Data Type (Value Type) is Logic

The screenshot shows the 'Display' configuration screen for channel CH3_4. It features a 'Sub Channel' selector set to 4, a 'Position' input field with value 0.00div, a 'V Zoom' dropdown menu set to x 1, and a 'Display Group' selector with options 1, 2, 3, 4, and M. Brackets and text labels identify these elements: 'Specify the sub channel. (Tap + or - to change.)' points to the Sub Channel selector; 'Vertical position (Tap + or - to adjust.)' points to the Position input field; 'Vertical zoom' points to the V Zoom dropdown menu; and 'Display group' points to the Display Group selector.

One Shot Output (One shot)

2. Tap the **One Shot** tab.
3. Tap each item to set options and execute commands.

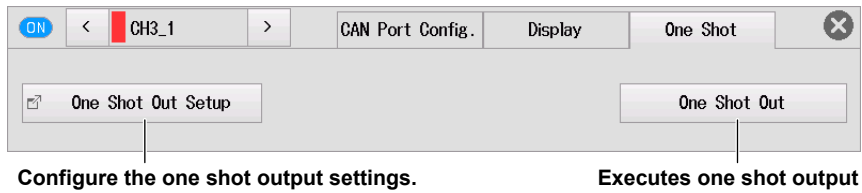

One Shot Output Settings (One Shot Out Setup)

4. Tap **One Shot Out Setup**. A One Shot Out Setup screen appears.

CAN Frame One-Shot Output (for the 720240 (CAN MONITOR), 720241 (CAN & LIN) modules)

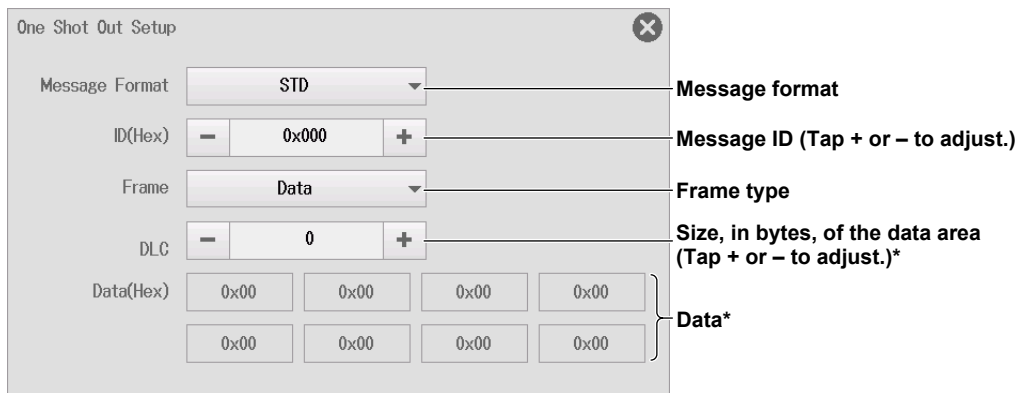

* These are the items you set when the frame type is set to data (Data).

CAN or CAN FD Frame One-Shot Output (for the 720242 (CAN/CAN FD) module)

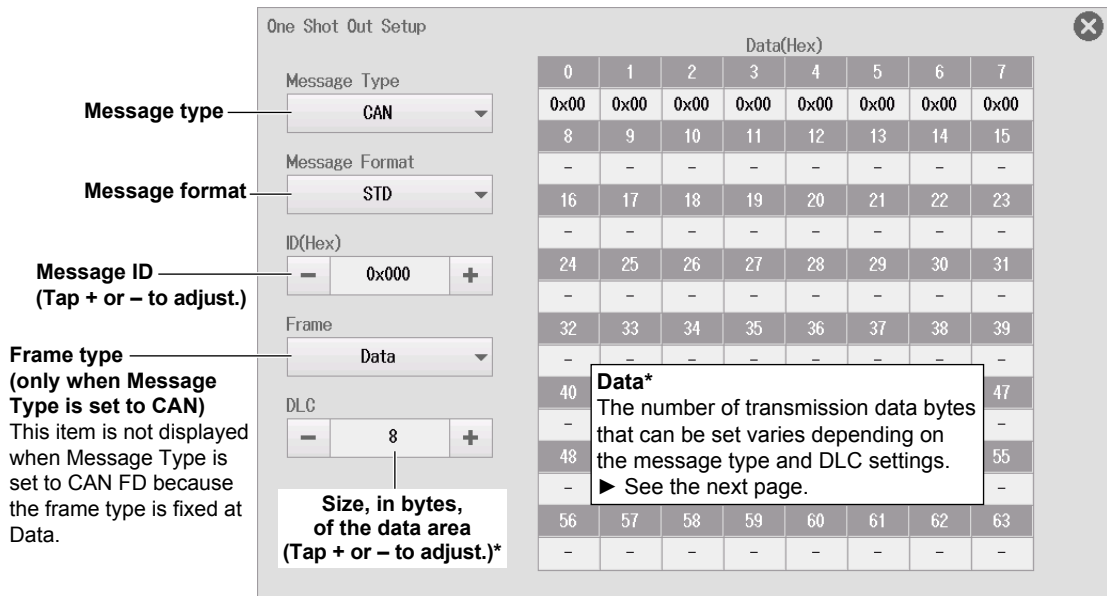

* These are the items you set when the frame type is set to data (Data).

2.10 Configuring the Monitoring of CAN and CAN FD Bus Signals (/VE option)

DLC value and the number of transmission data bytes

When DLC = 0 to 8

DLC	Number of Data Bytes		DLC	Number of Data Bytes		DLC	Number of Data Bytes	
	CAN	CAN FD		CAN	CAN FD		CAN	CAN FD
0	0	0	1	1	1	2	2	2
0	1	2	3	4	5	6	7	
-	-	-	0x00	-	-	0x00	0x00	-
3	3	3	4	4	4	5	5	5
0	1	2	3	4	5	6	7	
0x00	0x00	0x00	0x00	0x00	-	-	-	-
6	6	6	7	7	7	8	8	8
0	1	2	3	4	5	6	7	
0x00	0x00	0x00	0x00	0x00	0x00	0x00	0x00	-

When DLC ≥ 9

- When the message type is CAN

DLC	Number of Data Bytes
9 to 15	8

- When the message type is CAN FD

DLC	Number of Data Bytes	DLC	Number of Data Bytes	DLC	Number of Data Bytes											
9	12	10	16	11	20											
0	1	2	3	4	5	6	7									
0x00	0x00	0x00	0x00	0x00	0x00	0x00	0x00	0x00	0x00	0x00	0x00	0x00	0x00	0x00	0x00	0x00
8	9	10	11	12	13	14	15									
0x00	0x00	0x00	0x00	-	-	-	-	0x00	0x00	0x00	0x00	0x00	0x00	0x00	0x00	0x00
16	17	18	19	20	21	22	23									
-	-	-	-	-	-	-	-	0x00	0x00	0x00	0x00	0x00	0x00	0x00	0x00	0x00
12	24	13	32	14	48											
0	1	2	3	4	5	6	7									
0x00	0x00	0x00	0x00	0x00	0x00	0x00	0x00	0x00	0x00	0x00	0x00	0x00	0x00	0x00	0x00	0x00
8	9	10	11	12	13	14	15									
0x00	0x00	0x00	0x00	0x00	0x00	0x00	0x00	0x00	0x00	0x00	0x00	0x00	0x00	0x00	0x00	0x00
16	17	18	19	20	21	22	23									
0x00	0x00	0x00	0x00	0x00	0x00	0x00	0x00	0x00	0x00	0x00	0x00	0x00	0x00	0x00	0x00	0x00
24	25	26	27	28	29	30	31									
-	-	-	-	-	-	-	-	0x00	0x00	0x00	0x00	0x00	0x00	0x00	0x00	0x00
32	33	34	35	36	37	38	39									
-	-	-	-	-	-	-	-	0x00	0x00	0x00	0x00	0x00	0x00	0x00	0x00	0x00
40	41	42	43	44	45	46	47									
-	-	-	-	-	-	-	-	0x00	0x00	0x00	0x00	0x00	0x00	0x00	0x00	0x00
15	64															
0	1	2	3	4	5	6	7									
0x00	0x00	0x00	0x00	0x00	0x00	0x00	0x00	0x00	0x00	0x00	0x00	0x00	0x00	0x00	0x00	0x00
8	9	10	11	12	13	14	15									
0x00	0x00	0x00	0x00	0x00	0x00	0x00	0x00	0x00	0x00	0x00	0x00	0x00	0x00	0x00	0x00	0x00
16	17	18	19	20	21	22	23									
0x00	0x00	0x00	0x00	0x00	0x00	0x00	0x00	0x00	0x00	0x00	0x00	0x00	0x00	0x00	0x00	0x00
24	25	26	27	28	29	30	31									
0x00	0x00	0x00	0x00	0x00	0x00	0x00	0x00	0x00	0x00	0x00	0x00	0x00	0x00	0x00	0x00	0x00
32	33	34	35	36	37	38	39									
0x00	0x00	0x00	0x00	0x00	0x00	0x00	0x00	0x00	0x00	0x00	0x00	0x00	0x00	0x00	0x00	0x00
40	41	42	43	44	45	46	47									
0x00	0x00	0x00	0x00	0x00	0x00	0x00	0x00	0x00	0x00	0x00	0x00	0x00	0x00	0x00	0x00	0x00
48	49	50	51	52	53	54	55									
0x00	0x00	0x00	0x00	0x00	0x00	0x00	0x00	0x00	0x00	0x00	0x00	0x00	0x00	0x00	0x00	0x00
56	57	58	59	60	61	62	63									
0x00	0x00	0x00	0x00	0x00	0x00	0x00	0x00	0x00	0x00	0x00	0x00	0x00	0x00	0x00	0x00	0x00

2.11 Configuring the Monitoring of LIN Bus Signals (/VE option)

This section explains the following settings for monitoring LIN bus signals:

Items Common to Scope Mode and Recorder Mode

- LIN port configuration (waveform display on/off, frame and all sub channel settings, loading LIN data definition files, scaling all sub channels)
- Display settings (display range of each sub channel, scaling each sub channel, vertical position of each sub channel, vertical zoom of each sub channel (zooming by setting the magnification), display groups)

► [Features Guide: “LIN Bus Signal Monitoring”](#)

Channel Setting Menu

1. On the waveform screen, tap **MENU > Channel > CH2** or **CH4**. A channel setting menu appears.
You can also tap or double-tap CH2 or CH4 in the channel information area to display the channel setting menu.
(If the channel is selected, tap; otherwise, double-tap.)

LIN Port Configuration (LIN Port Config)

2. Tap the **LIN Port Config.** tab.
3. Tap each item to set options and execute commands.

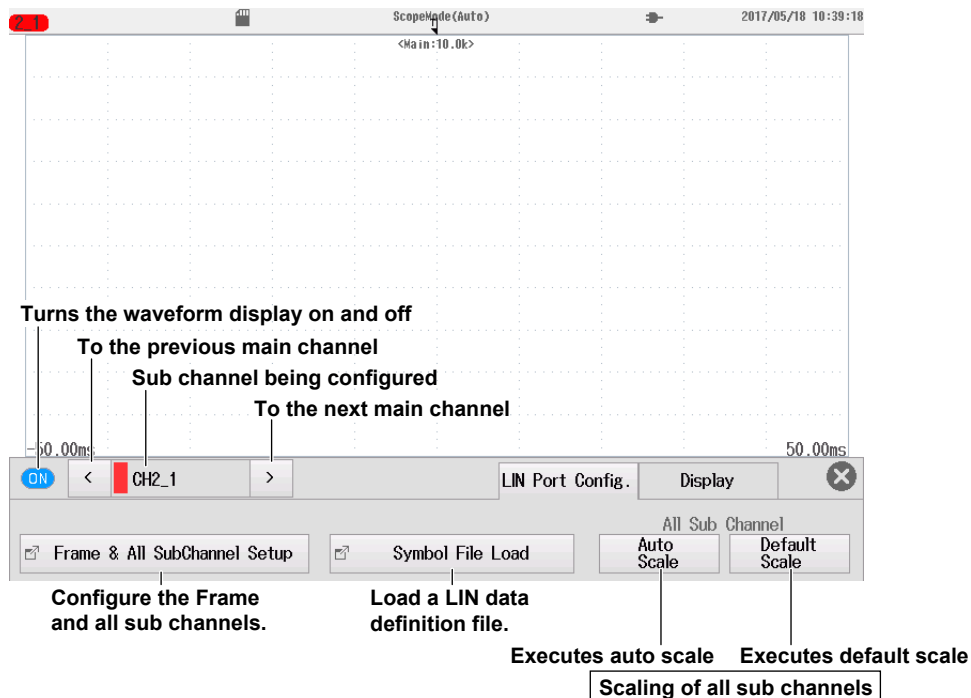

Frame and All Sub Channel Settings (Frame & All SubChannel Setup)

4. Tap **Frame & All SubChannel Setup**. A Frame & All SubChannel Setup screen appears.

Frame Settings (Frame Setup)

5. Tap the **Frame Setup** tab. The following screen appears.
6. Tap each item. Use the displayed list (options) or input box to set the items.

To set frames 0 to 59 to the same setting at once, change the settings in the All row. You cannot change the settings for frames 60 or above at once.

Data length			Checksum type			Bit rate		
Frame & All SubChannel Setup	Channel Setup	Frame Setup	All SubChannel Setup	All SubChannel Factor/Offset				
	Bit Rate	19200bps						
ID	Data Length	Checksum	ID	Data Length	Checksum	ID	Data Length	Checksum
All	1	Classic	-	-	-	-	-	-
0x00(0)	1	Classic	0x01(1)	1	Classic	0x02(2)	1	Classic
0x03(3)	1	Classic	0x04(4)	1	Classic	0x05(5)	1	Classic
0x06(6)	1	Classic	0x07(7)	1	Classic	0x08(8)	1	Classic
0x09(9)	1	Classic	0x0a(10)	1	Classic	0x0b(11)	1	Classic
0x0c(12)	1	Classic	0x0d(13)	1	Classic	0x0e(14)	1	Classic
0x0f(15)	1	Classic	0x10(16)	1	Classic	0x11(17)	1	Classic
0x12(18)	1	Classic	0x13(19)	1	Classic	0x14(20)	1	Classic
0x15(21)	1	Classic	0x16(22)	1	Classic	0x17(23)	1	Classic

Slide to display zoom frames that do not fit in the screen.

Note

All IDs are displayed. Only the settings for the frames that have IDs that data will be read for will be enabled. The settings for frames that have other IDs will be ignored.

All Sub Channel Setup (All SubChannel Setup - LIN Data Extraction Conditions)

5. Tap the **All SubChannel Setup** tab. The following screen appears.
6. Tap each item. Use the displayed list (options) or input box to set the items.

Turns the sub channel monitoring on and off

To set all the sub channels to the same setting, change the settings in the All row.

LIN data extraction conditions							
Frame & All SubChannel Setup	Channel Setup	Frame Setup	All SubChannel Setup	All SubChannel Factor/Offset			
	Input	Label	ID(Hex)	Start Bit	Bit Cnt	Byte Order	Value Type
All	OFF						
1	OFF	CH2_1	0x00	0	8	Little	Unsigned
2	OFF	CH2_2	0x00	0	8	Little	Signed
3	+	CH2_3	0x00	0	8	Little	Logic
4	OFF	CH2_4	0x00	0	8	Little	Unsigned
5	OFF	CH2_5	0x00	0	8	Little	Unsigned
6	OFF	CH2_6	0x00	0	8	Little	Unsigned
7	OFF	CH2_7	0x00	0	8	Little	Unsigned
8	OFF	CH2_8	0x00	0	8	Little	Unsigned
9	OFF	CH2_9	0x00	0	8	Little	Unsigned
10	OFF	CH2_10	0x00	0	8	Little	Unsigned

Slide to display channels that do not fit in the screen.

2.11 Configuring the Monitoring of LIN Bus Signals (/VE option)

All Sub Channel Factor/Offset (All SubChannel Factor/Offset - LIN Data Conversion Condition)

5. Tap the **All SubChannel Factor/Offset** tab. The following screen appears.
6. Tap each item. Use the displayed input box to set the items.

LIN data conversion conditions

Frame 8 All SubChannel Setup		Frame Setup	All SubChannel Setup	All SubChannel Factor/Offset	
	Input	Label	Factor	Offset	Unit
All	<input type="radio"/>				
1	<input type="radio"/>	CH2_1	1.0000	0.0000	
2	<input type="radio"/>	CH2_2	1.0000	0.0000	
3	<input checked="" type="radio"/>	CH2_3	*	*	*
4	<input type="radio"/>	CH2_4	1.0000	0.0000	
5	<input type="radio"/>	CH2_5	1.0000	0.0000	
6	<input type="radio"/>	CH2_6	1.00		
7	<input type="radio"/>	CH2_7	1.0000	0.0000	
8	<input type="radio"/>	CH2_8	1.0000	0.0000	
9	<input type="radio"/>	CH2_9	1.0000	0.0000	
10	<input type="radio"/>	CH2_10	1.0000	0.0000	

* You cannot set Factor, Offset, or Unit when the data type (Value Type) is set to Logic.

Loading a LIN Data Definition File (Symbol File Load)

4. Tap **Symbol File Load**. A file list appears.
5. On the file list, tap a symbol file (SBL file).
For details on file list operations, see section 6.10.
6. Select the load destination channel.
▶ section 6.9
7. Tap **Load**. A confirmation message appears.
8. Tap **OK**. The symbol file is loaded.

Sub Channel Display Settings (Display)

2. Tap the **Display** tab.
3. Tap each item. Use the displayed list (options) or input box to set the items.

When the Data Type (Value Type) is Unsigned or Signed

The screenshot shows the 'Display' configuration for CH2_1. It includes a 'Sub Channel' selector set to 1, 'Upper' and 'Lower' limit input fields with values 400.00 and -100.00 respectively, 'Auto Scale' and 'Default Scale' buttons, and a 'Display Group' selector with options 1, 2, 3, 4, and M. Brackets and arrows point from these elements to descriptive text below.

Upper and lower limits of the display range

Specify the sub channel. (Tap + or – to change.)

Executes auto scale

Executes default scale

Scaling of the specified sub channel

Display group

When the Data Type (Value Type) is Logic

The screenshot shows the 'Display' configuration for CH2_3. It includes a 'Sub Channel' selector set to 3, a 'Position' input field with '0.00div', a 'V Zoom' dropdown menu set to 'x 1', and a 'Display Group' selector with options 1, 2, 3, 4, and M. Brackets and arrows point from these elements to descriptive text below.

Vertical position (Tap + or – to adjust.)

Vertical zoom

Specify the sub channel. (Tap + or – to change.)

Display group

2.12 Configuring the Monitoring of SENT Signals (/VE option)

This section explains the following settings for monitoring SENT signals:

Items Common to Scope Mode and Recorder Mode

- SENT port configuration (waveform display on/off, SENT format, error channel, input settings, all sub channel settings, error count reset)
- Display settings (display range of each sub channel, scaling each sub channel, vertical position of each sub channel, vertical zoom of each sub channel (zooming by setting the magnification), display groups)

► [Features Guide: “SENT Signal Monitoring”](#)

Channel Setting Menu

1. On the waveform screen, tap **MENU > Channel >** any channel from **CH1 to CH4**. A channel setting menu appears.
You can also tap or double-tap any channel from CH1 to CH4 in the channel information area to display the channel setting menu.
(If the channel is selected, tap; otherwise, double-tap.)

SENT Port Configuration (SENT Port Config)

2. Tap the **SENT Port Config.** tab.
3. Tap each item to set options and execute commands.

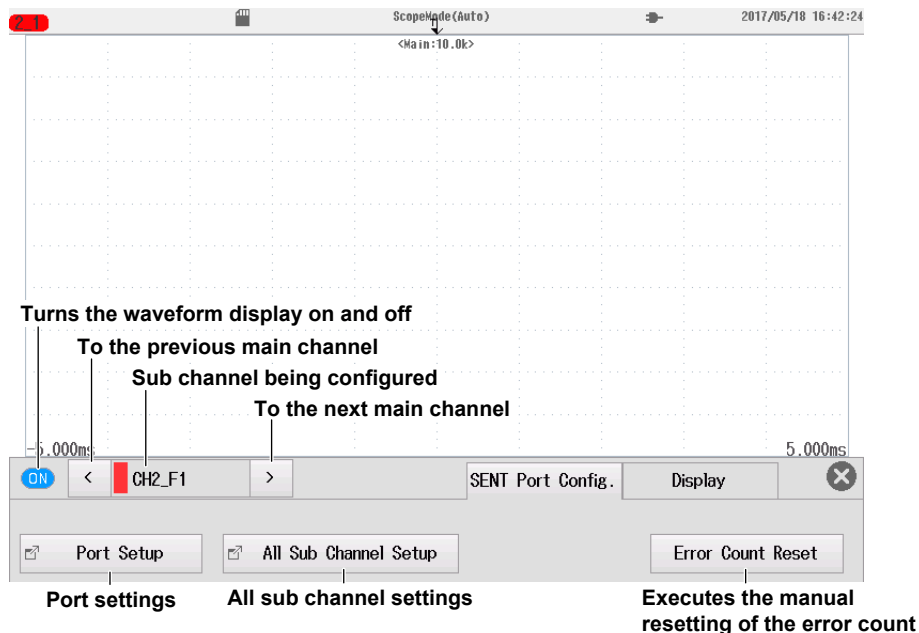

Port Settings (Port Setup)

4. Tap **Port Setup**. A Port Setup screen appears.

SENT Format (SENT Format)

5. Tap the **SENT Format** tab. The following screen appears.
6. Tap each item. Use the displayed list (options) or input box to set the items.

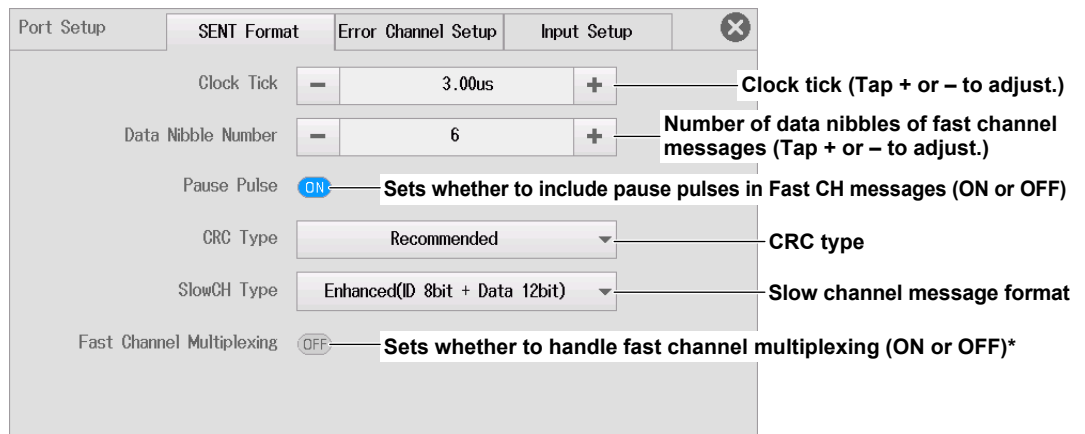

* You can set fast channel multiplexing when the SENT monitor module (720243(SENT)) version is 0x07 or later.

Error Channel Settings (Error Channel Setup)

5. Tap the **Error Channel Setup** tab. The following screen appears.
6. Tap each item to set options and execute commands.

Turns error detection on and off (Successive Calibration Pulses (Option2) only)

Error detection (Detect) is always on for Fast Channel CRC, Slow Channel CRC, Nibble Value, and Pulse Number.

Turns error trigger display on and off

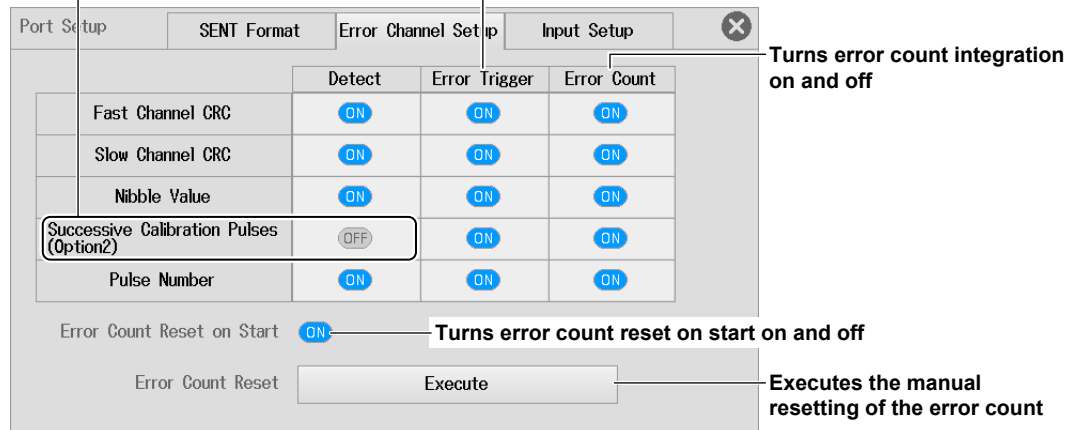

Input Settings (Input Setup)

5. Tap the **Input Setup** tab. The following screen appears.
6. Tap each item. Use the displayed list (options) or input box to set the items.

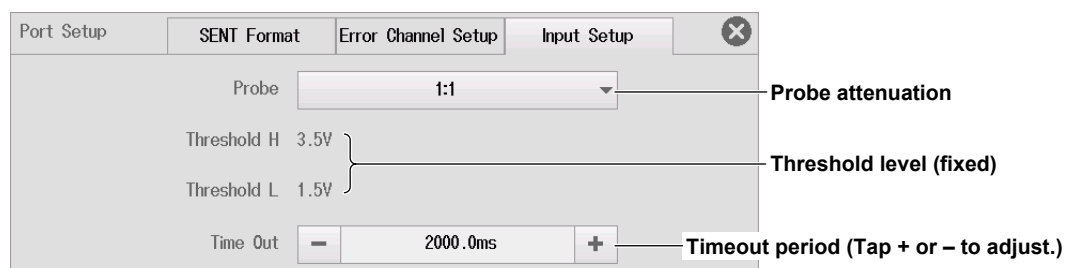

All Sub Channel Setup (All Sub Channel Setup)

4. Tap All Sub Channel Setup. An All Sub Channel Setup screen appears.

All Sub Channel Settings (All SubChannels Setup - SENT Data Extraction Conditions)

5. Tap the All SubChannel Setup tab. The following screen appears.
6. Tap each item. Use the displayed list (options) or input box to set the items.

Turns the sub channel monitoring on and off

Data type			SENT data extraction conditions*						
	Data Type	Input	Label	ID	Endian	Start Bit	Bit Size	Value Type	
1	FastCH	<input checked="" type="checkbox"/>	CH1_F1		Big	0	12	Unsigned	
2	FastCH	<input checked="" type="checkbox"/>	CH1_F2		Big	12	12	Unsigned	
3	FastCH	<input checked="" type="checkbox"/>	CH1_F3		Big	0	12	Unsigned	
4	S&C	<input checked="" type="checkbox"/>	CH1_SC						
	_1	<input checked="" type="checkbox"/>	Bit0						
	_2	<input checked="" type="checkbox"/>	Bit1						
	_3	<input checked="" type="checkbox"/>	Bit2						
	_4	<input checked="" type="checkbox"/>	Bit3						
5	SlowCH	<input checked="" type="checkbox"/>	CH1_S1	0x00		0	12	Unsigned	
6	SlowCH	<input checked="" type="checkbox"/>	CH1_S2	0x00		0	12	Unsigned	
7	SlowCH	<input checked="" type="checkbox"/>	CH1_S3	0x00		0	12	Unsigned	

 Slide to display channels that do not fit in the screen.

When Fast Channel Multiplexing is set to ON

If you tap a sub channel whose data type (Data Type) is set to FastCH, the ID column changes to an FC column, and you can set FC (Frame Control).
 If you tap a sub channel whose data type is set to SlowCH, you can set ID.

	Data Type	Input	Label	FC	Endian	Start Bit	Bit Size	Value Type
1	FastCH	<input checked="" type="checkbox"/>	CH1_F1	0x00	Big	0	12	Unsigned
2	FastCH	<input checked="" type="checkbox"/>	CH1_F2	0x00	Big	12	12	Unsigned
3	FastCH	<input checked="" type="checkbox"/>	CH1_F3	0x00				
	_3							
	_4	<input checked="" type="checkbox"/>	Bit3					
5	FastCH	<input checked="" type="checkbox"/>	CH1_S1	0x00	Big	0	12	Unsigned
6	SlowCH	<input checked="" type="checkbox"/>	CH1_S2	0x00		0	12	Unsigned
7	SlowCH	<input checked="" type="checkbox"/>	CH1_S3	0x00		0	12	Unsigned
8	SlowCH	<input checked="" type="checkbox"/>	CH1_S4	0x00		0	12	Unsigned
9	SlowCH	<input checked="" type="checkbox"/>	CH1_S5	0x00		0	12	Unsigned
10	Error Trigger	<input checked="" type="checkbox"/>	CH1_ET					
11	Error Count	<input checked="" type="checkbox"/>	CH1_EC					

Switch the data type.

Sub Channel and Data Type

The types of data acquired in sub channels are as follows.

Sub Channel	Data Type	
1		
2	FastCH	
3		
4	S&C (Stauts & Communication)	
5		
6		
7	SlowCH, FastCH*	* You can change this to FastCH only when Fast Channel Multiplexing is set to ON.
8		
9		
10	Error Trigger	
11	Error Count	

All Sub Channel Factor/Offset (All SubChannel Factor/Offset - SENT Data Conversion Condition)

5. Tap the **All SubChannel Factor/Offset** tab. The following screen appears.
6. Tap each item. Use the displayed input box to set the items.

SENT data conversion conditions

All Sub Channel Setup

All SubChannel Setup

All SubChannel Factor/Offset

✕

	Data Type	Input	Label	Factor	Offset	Unit
1	FastCH	<input checked="" type="checkbox"/>	CH2_F1	1.0000	0.0000	
2	FastCH	<input checked="" type="checkbox"/>	CH2_F2	1.0000	0.0000	
3	FastCH	<input checked="" type="checkbox"/>	CH2_F3	1.0000	0.0000	
4	S&C	<input checked="" type="checkbox"/>	CH2_SC			
_1		<input checked="" type="checkbox"/>	Bit0			
_2		<input checked="" type="checkbox"/>	Bit1			
_3		<input checked="" type="checkbox"/>	Bit2			
_4		<input checked="" type="checkbox"/>	Bit3			
5	SlowCH	<input checked="" type="checkbox"/>	CH2_S1	1.0000	0.0000	
6	SlowCH	<input checked="" type="checkbox"/>	CH2_S2	1.0000	0.0000	
7	SlowCH	<input checked="" type="checkbox"/>	CH2_S3	1.0000	0.0000	

↑ Slide to display channels that do not fit in the screen.

Sub Channel Display Settings (Display)

2. Tap the **Display** tab.
3. Tap each item. Use the displayed list (options) or input box to set the items.

When the Data Type Is Fast CH, SlowCH, or Error Count

Sub Channel: 1

Upper: 4.5000E+03

Lower: -500.00

Auto Scale

Default Scale

Display Group: 1 2 3 4 M

Upper and lower limits of the display range

Specify the sub channel.
(Tap + or - to change.)

Executes auto scale

Executes default scale

Scaling of the specified sub channel

When the Data Type Is S&C (Status & Communication) and Error Trigger

Sub Channel: 4

Position: 0.00div

V Zoom: x 1

Display Group: 1 2 3 4 M

Vertical position (Tap + or - to adjust.)

Vertical zoom

Specify the sub channel.
(Tap + or - to change.)

2.13 Configuring the GPS Position Information Monitor

This section explains the following settings for monitoring position information with the GPS (Global Positioning System).

To acquire GPS position information, a GPS unit (an accessory sold separately) must be connected to the instrument and the position information acquisition setting must be turned on (see section 18.1).

Items Common to Scope Mode and Recorder Mode

- Common settings (All Items Setup)
- Basic settings (position information, display labels, range, 3D positioning status, GPS time sync status)
- Display settings (position information, display range, vertical position, vertical zoom, display groups)

► [Features Guide: “Position Information \(GPS\)”](#)

1. Set position information acquisition to ON. For the procedure, see section 18.1.

Channel Setting Menu

2. On the waveform screen, tap **MENU > Channel > GPS**. A channel setting menu appears. You can also tap or double-tap GPS in the channel information area to display the channel setting menu. (If the channel is selected, tap; otherwise, double-tap.)

Common Settings (Common)

3. Tap the **Common** tab.
4. Tap each item to set options.

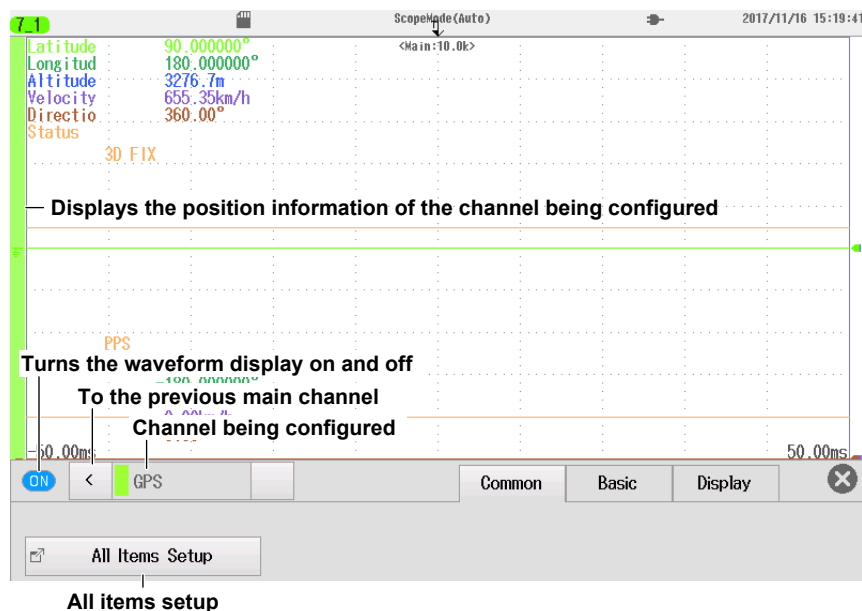

All Items Setup (All Items Setup)

5. Tap the **All Items Setup** tab. The following screen appears.
6. Tap each item. Use the displayed list (options) or input box to set the items.

Display on/off state of each position information entry

Display label

Measurement range

Upper and lower limits of the display range
When the position information is status (Status), set the vertical position and vertical zoom.

	Disp	Label	Range	Upper	Lower
1	<input checked="" type="checkbox"/>	Latitude		90.000000°	-90.000000°
2	<input checked="" type="checkbox"/>	Longitude		180.000000°	-180.000000°
3	<input checked="" type="checkbox"/>	Altitude	3276.7m	3276.7m	-3276.8m
4	<input checked="" type="checkbox"/>	Velocity	655.35km/h	655.35km/h	0.00km/h
5	<input checked="" type="checkbox"/>	Direction		360.00°	0.00°
6	<input checked="" type="checkbox"/>	Status		0.00div	x 1
_1		3D FIX			
_2		PPS			

Basic Setup (Basic)

3. Tap the **Basic** tab.
4. Tap **Item**. Use the displayed list (options) to set the position information.
5. Tap each item. Use the displayed list (options) or input box to set the items.

Latitude (Latitude), Longitude (Longitude), Direction (Direction)

Display on/off state of each position information entry

Set the position information to Latitude, Longitude, or Direction.

Display label

Altitude (Altitude)



Velocity (Velocity)

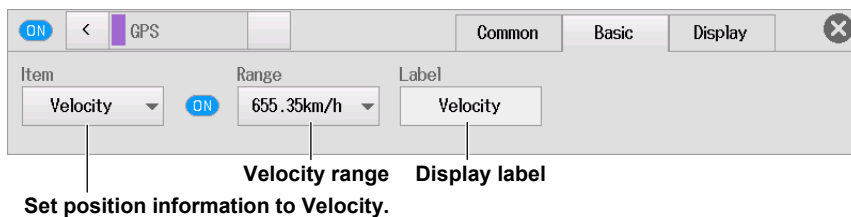

Status (Status)

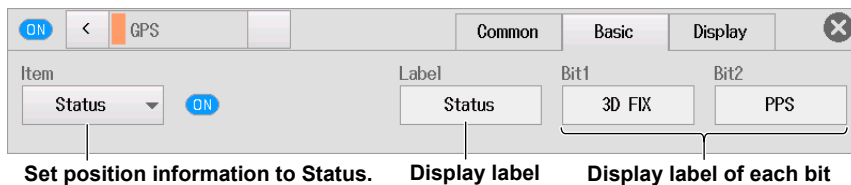

Configuring the Display (Display)

3. Tap the **Display** tab.
4. Tap **Item**. Use the displayed list (options) to set the position information.
5. Tap each item. Use the displayed list (options) or input box to set the items.

Latitude (Latitude), Longitude (Longitude), Direction (Direction), Altitude (Altitude), Velocity (Velocity)

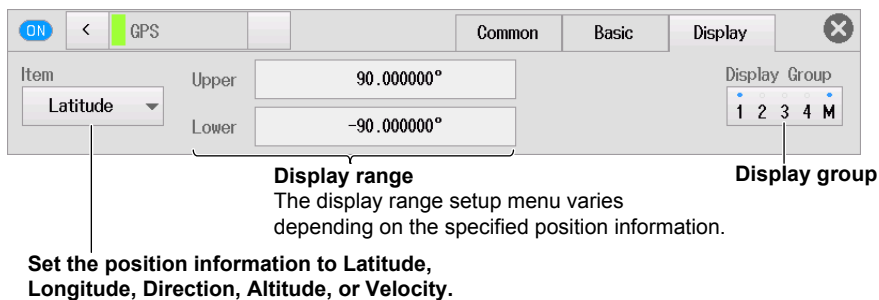

Status (Status)

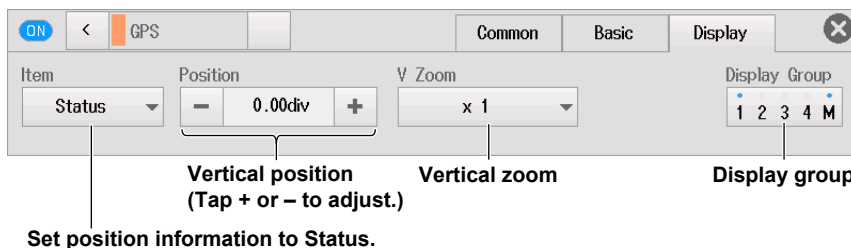

3.1 Setting Conditions for Waveform Acquisition (Scope mode)

This section explains the following settings for acquiring waveforms.

Applicable to Scope Mode

- Basic settings (time scale, record length, acquisition mode, waveform acquisition count)
- Detail settings (time base, trigger position, trigger delay)
- Action/SD recording (action (action mode, action settings), SD recording (auto naming, file name, detail settings))

For recorder mode, see section 3.2.

► [Features Guide: “Waveform Acquisition”](#)

Waveform Acquisition Basic Setting Menu

1. On the waveform screen, tap **MENU** > **Acquire**. The Acquire menu appears.
2. Tap the **Basic** tab.
3. Tap each item. Use the displayed list (options) or input box to set the items.

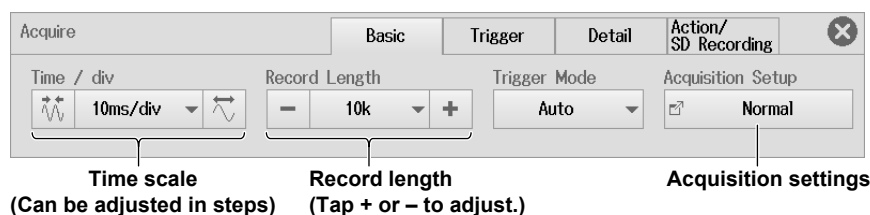

Acquisition Settings (Acquisition Setup)

4. Tap **Acquisition Setup**. Tap **Acquisition Mode**. Use the displayed list (options) to select the acquisition mode.

Acquisition Mode

Normal: Displays waveforms without processing the sampled data. Set the waveform acquisition count.

Envelope: Displays waveforms in envelope mode. Set the waveform acquisition count.

Average: Displays averaged waveforms. Set the average count or attenuation constant.

- **Normal Mode (Normal), Envelope Mode (Envelope)**

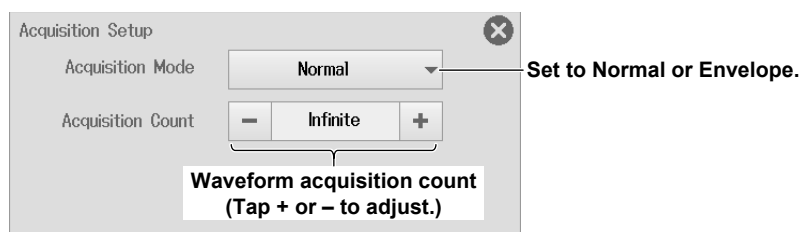

3.1 Setting Conditions for Waveform Acquisition (Scope mode)

- **Averaging Mode (Average)**

Acquisition Setup

Acquisition Mode: Average

Average Count: Infinite

Weight: 16

Set to Average.

Average count
Slide to display counts that do not fit in the screen.

Attenuation constant
Set this when the average count is set to Infinite.

Waveform Acquisition Detail Setting Menu

2. Tap the **Detail** tab.
3. Tap **Time Base**. Use the displayed list (options) to set the time base.
4. Tap each item. Use the displayed input box to set the items.

When the time base is the internal clock signal

Acquire

Basic | Trigger | **Detail** | Action/SD Recording

Time Base: Internal

Position: 50.0%

Trigger Delay: 0us

Set to Internal.

Trigger position
(Tap + or - to adjust.)

Trigger delay
(Tap + or - to adjust.)

When the time base is an external clock signal

Acquire

Basic | Trigger | **Detail** | Action/SD Recording

Time Base: External

Pulse/Rotate: 1

Position: 50.0%

Set to External.

Pulse/rotation
(Tap + or - to adjust.)

Trigger position
(Tap + or - to adjust.)

Waveform Acquisition Action/SD Recording

2. Tap the Action/SD Recording tab.

Action (Action)

When the acquisition mode is set to Normal (Normal) or Envelope (Envelop), you can set an action.

3. Tap Action/SD Recording, and select the action (Action).
4. Tap each item. Use the displayed list (options) or input box to set the items.

Set to Action.

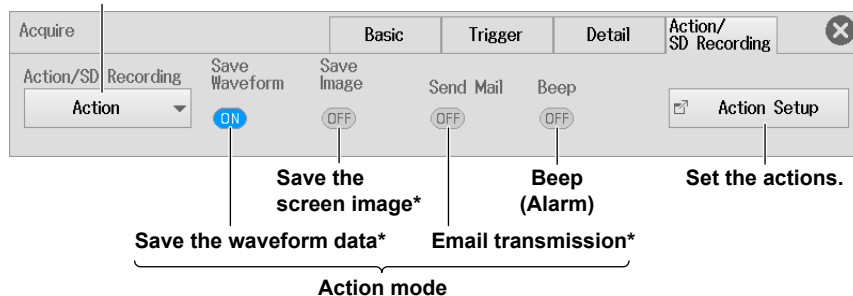

Action Settings (Action Setup)

5. Tap Action Setup. The following screen appears.

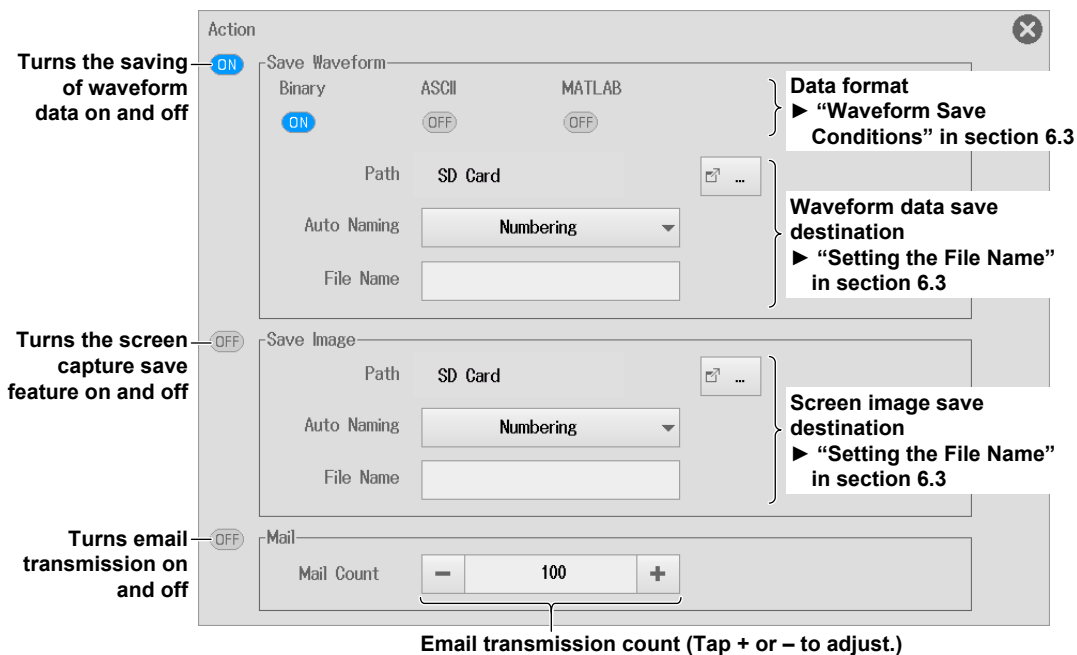

3.1 Setting Conditions for Waveform Acquisition (Scope mode)

SD Recording (SD Recording)

When the acquisition mode is set to Normal (Normal) or Envelope (Envelop), you can set SD recording.

3. Tap **Action/SD Recording**, and select SD Recording (SD Recording).
4. Tap each item. Use the displayed list (options) or input box to set the items.

Set to SD Recording.



Detail Settings (Detail Setup)

5. Tap **Detail Setup**. The following screen appears.

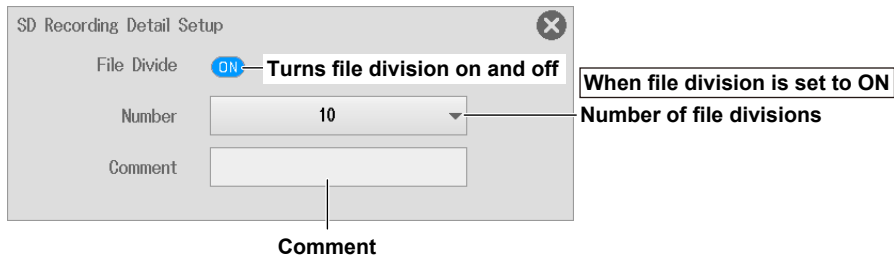

3.2 Setting Conditions for Waveform Acquisition (Recorder mode)

This section explains the following settings for acquiring waveforms.

Applicable to Recorder Mode

- Basic settings (acquisition time/acquisition length, sample interval, record time/record length, numeric recording interval, acquisition condition, acquisition method)
- Detail settings (acquisition method, acquisition mode, time base)

For scope mode, see section 3.1.

► [Features Guide: "Waveform Acquisition"](#)

Waveform Acquisition Basic Setting Screen

1. On the waveform screen, tap **MENU** > **Acquire**. The Acquire screen appears.
2. Tap the **Basic** tab. The basic setting screen appears.
3. Tap each item. Use the displayed list (options) or input box to set the items.

Sample interval
Slide to display sample intervals that do not fit in the screen.

The displayed items vary depending on the acquisition method and time base settings. ► "Acquisition Method" on the next page

Acquire **Acquisition time** Basic Detail

Acquisition Time 10s Sample Interval 10us

Acquisition Condition
Acquisition Time
When the START/STOP key is pressed, the acquisition starts. It automatically stops after the set acquisition time.

Acquisition Method
Memory
Acquire data into internal memory. The acquisition data will be lost at the next START or power OFF.

Start End
Acquisition Time
(Max. 10day 00hour)

The display changes depending on the selected acquisition condition and acquisition method.

Acquisition Condition (Acquisition Condition)

* When the acquisition method is SD Recording (SD Recording), this item is not available.

4. Tap **Acquisition Condition**. Use the displayed list (options) to set the acquisition condition.

There are four acquisition conditions.

- Acquisition time (Acquisition Time)
- Continuous acquisition (Continuous)
- Start acquisition on trigger (Start On Trigger)
- Stop acquisition on trigger (Stop On Trigger)

Acquisition Method (Acquisition Method)

5. Tap **Acquisition Method**. Use the displayed list (options) to set the acquisition method.

You can also set the acquisition method in the detail settings explained later.

Memory (Memory), Memory + Save on Stop (Memory + Save on Stop)

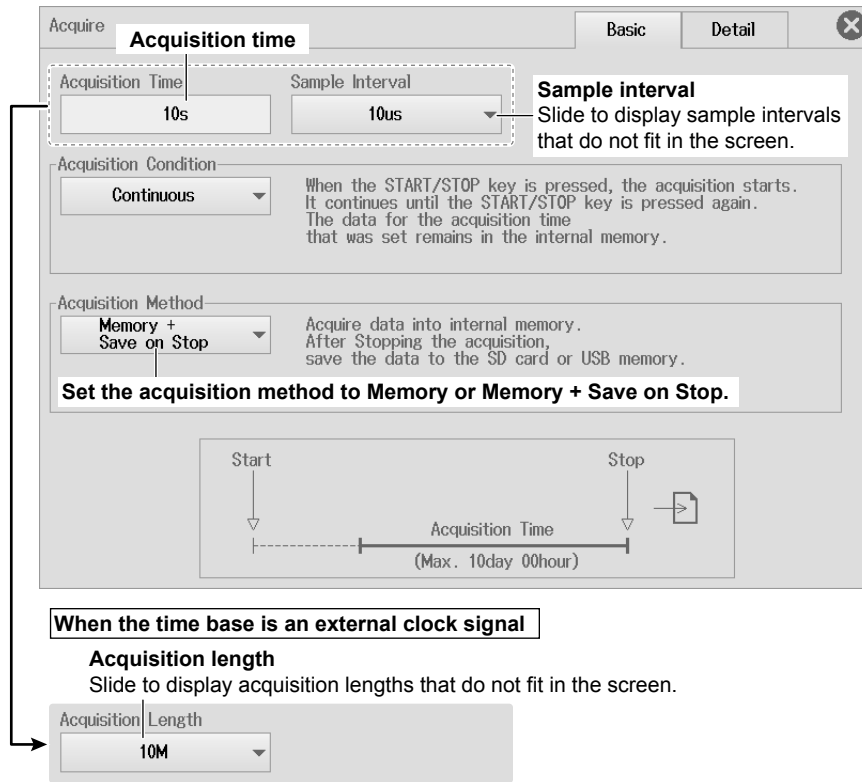

For time base settings, see "Detail" explained later.

Memory + SD Numeric Recording (Memory + SD Numeric Recording)

6. Tap **Numeric Interval**. Use the displayed list (options) to set the numeric recording interval.

Sample interval

Slide to display sample intervals that do not fit in the screen.

Acquire Acquisition time Basic Detail

Acquisition Time: 10s | Sample Interval: 10us | Numeric Interval: 1sec

Numeric recording interval
Slide to display numeric recording intervals that do not fit in the screen.

Acquisition Condition: Continuous
When the START/STOP key is pressed, the acquisition starts. It continues until the START/STOP key is pressed again. The data for the acquisition time that was set remains in the internal memory.

Acquisition Method: Memory + SD Numeric Recording
Acquire data into internal memory. At the same time, data is recorded in text format to the SD card. The recording interval is in text format.

Set the acquisition method to Memory + SD Numeric Recording.

Start | Stop
Acquisition Time (Max. 10day 00hour)

When the time base is an external clock signal

▶ “Memory (Memory), Memory + Save on Stop (Memory + Save on Stop)” on the previous page.

SD Recording (SD Recording)

Acquire Recording time Basic Detail

Record Time: 10s | Sample Interval: 10us

Sample interval
Slide to display sample intervals that do not fit in the screen.

Acquisition Method: SD Recording
Record data to the SD card. The sample interval is limited depending on the number of channels to be recorded.

Set the acquisition method to SD Recording.

Start | End
Record Time (Max. 50day 00hour)

When the time base is an external clock signal

Record length

Slide to display record lengths that do not fit in the screen.

Record Length: 10M

For time base settings, see “Detail” explained later.

Waveform Acquisition Detail Setting Screen

2. Tap the **Detail** tab. The Detail Setup screen appears.
3. Tap each item. Use the displayed list (options) or input box to set the items.

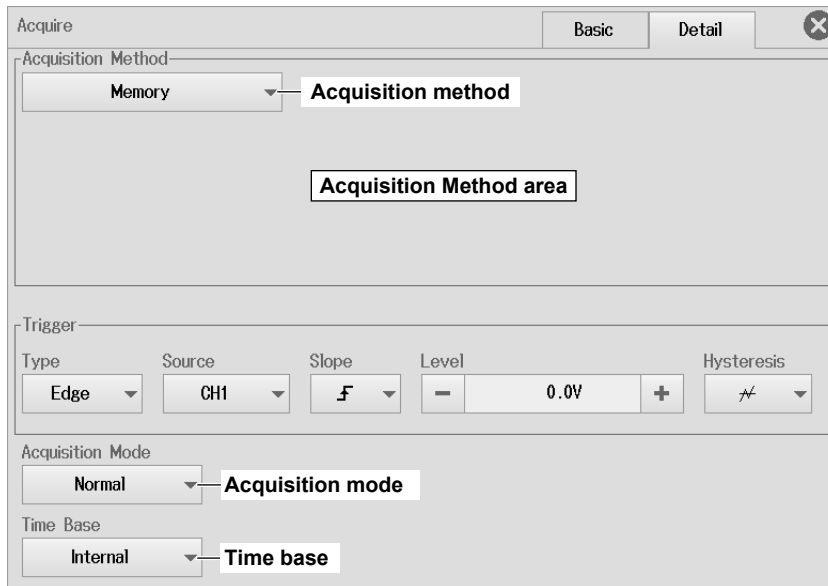

When the time base is an external clock signal

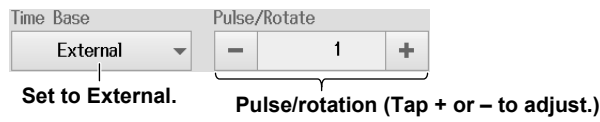

Acquisition Method (Acquisition Method)

4. Tap **Acquisition Method**. Use the displayed list (options) to set the acquisition method. The items shown in the Acquisition Method area vary depending on the specified acquisition method.

Memory (Memory)

- See the above figure.

Memory + Save on Stop (Memory + Save on Stop)

5. Tap each item. Use the displayed list (options) or input box to set the items.

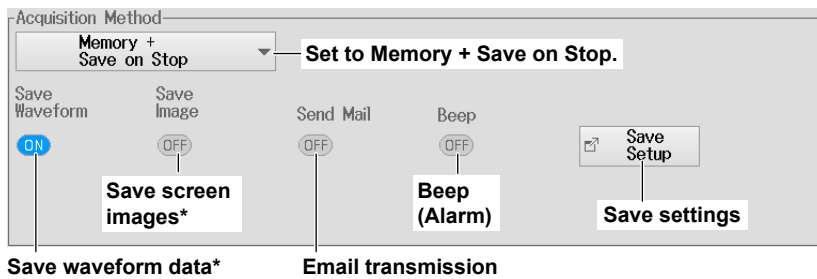

Set the actions you want to execute at the end of measurements to ON.

* You can turn waveform data saving and screen image saving on and off also on the save setting screen.

Save Settings (Save Setup)

6. Tap **Save Setup**. The following screen appears.

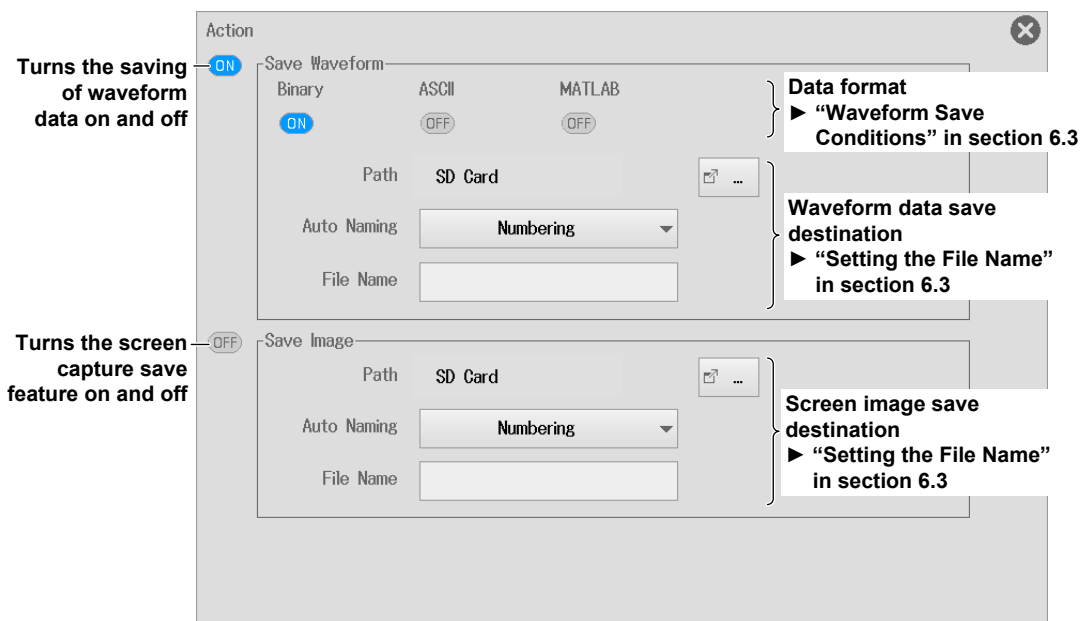

Memory + SD Numeric Recording (Memory + SD Numeric Recording)

5. Tap each item. Use the displayed list (options) or input box to set the items.

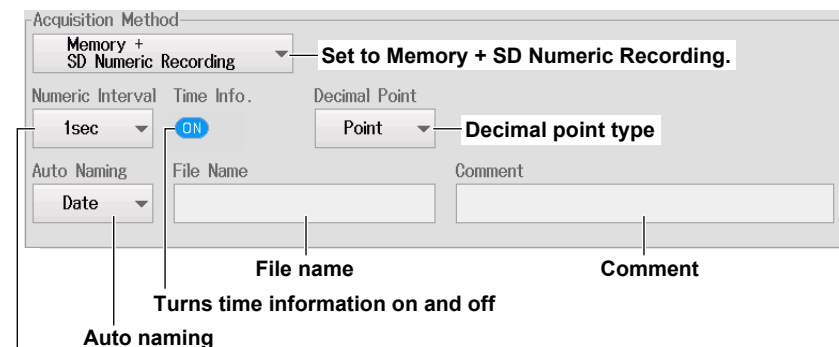

Numeric recording interval

Slide to display numeric recording intervals that do not fit in the screen.

SD Recording (SD Recording)

5. Tap each item. Use the displayed list (options) or input box to set the items.

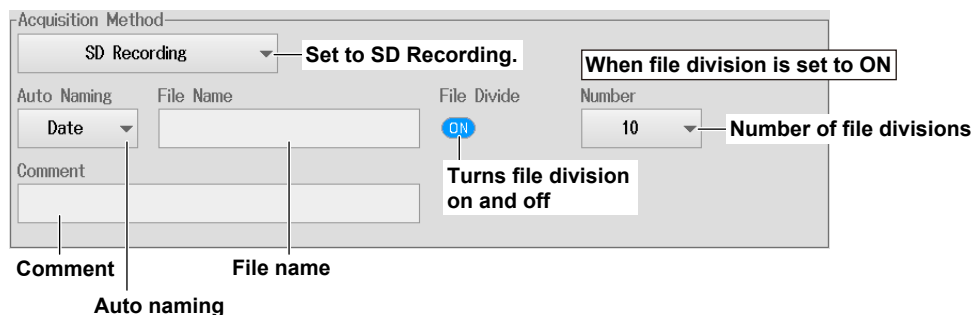

3.3 Starting and Stopping Waveform Acquisition

This section explains how to start and stop waveform acquisition.

Items Common to Scope Mode and Recorder Mode

START/STOP key

Waveform Acquisition (START/STOP)

Press **START/STOP** to start or stop waveform acquisition.

The key is illuminated while the instrument is acquiring waveforms.

▶ [Features Guide: “Waveform Acquisition \(START/STOP\)”](#)

4.1 Setting the Trigger Mode

This section explains the following setting for updating the displayed waveform.

Applicable to Scope Mode

Trigger mode

This setting is not available in recorder mode.

► [Features Guide: “Trigger mode \(Trigger Mode\)”](#)

Waveform Acquisition Basic Setting Menu

1. On the waveform screen, tap **MENU** > **Acquire**. The Acquire menu appears.
2. Tap the **Basic** tab.
3. Tap **Trigger Mode**. Use the displayed list (options) to select the trigger mode.

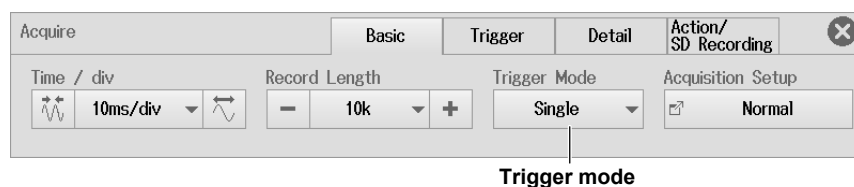

Trigger mode (Trigger Mode)

Auto

If the trigger conditions are met within a 50-ms timeout period, the instrument updates the displayed waveforms on each trigger occurrence. If not, the instrument automatically updates the displayed waveforms. If simple trigger is in use and the trigger source is set to Time, the instrument operates in Normal mode even when Auto mode is specified. If the time axis is set to a value that would cause the display to switch to roll mode, roll mode display will be enabled.

Normal

The instrument updates the waveform display only when the trigger conditions are met. If no triggers occur, the display is not updated. If you want to view waveforms that the instrument cannot trigger on, or if you want to check the ground level, use Auto mode.

Single

When the trigger conditions are met, the instrument updates the displayed waveform once and stops signal acquisition. If the time axis is set to a value that would cause the display to switch to roll mode, roll mode display will be enabled. When the instrument triggers, it begins recording data. When data has been acquired up to the amount specified by the set record length, the waveform display stops.

On Start

Regardless of the trigger settings, when you press the START key, the instrument updates the displayed waveforms once and stops signal acquisition. If the time axis is set to a value that would cause the display to switch to roll mode, roll mode display will be enabled. When data has been acquired up to the amount specified by the set record length, the waveform display stops.

4.2 Setting the Trigger Position and Trigger Delay

This section explains the following setting for updating the displayed waveform.

Applicable to Scope Mode

Trigger position and trigger delay

These settings are not available in recorder mode.

► [Features Guide: “Trigger Position \(Position\)”](#)
[“Trigger Delay \(Trigger Delay\)”](#)

Waveform Acquisition Detail Setting Menu

1. On the waveform screen, tap **MENU** > **Acquire**. The Acquire menu appears.
2. Tap the **Detail** tab > **Time Base**, and select Internal.
3. Tap each item. Use the displayed input box to set the items.

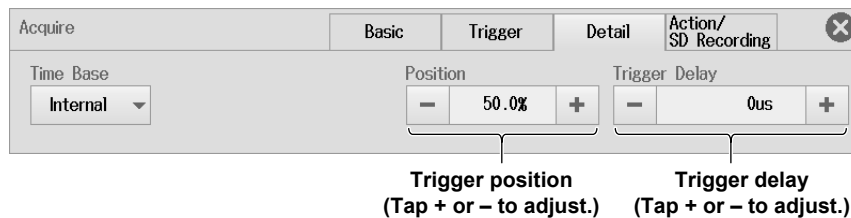

4.3 Triggering on an Edge Trigger

This section explains the following settings for triggering on the edges of an analog-signal trigger source:

For Scope Mode

Setting the trigger to Simple, trigger source, trigger slope, trigger level, trigger hysteresis

For Recorder Mode

Setting the trigger type to Edge, trigger source, trigger slope, trigger level, trigger hysteresis

- [Features Guide: “Trigger Settings \(Setting\),” “Trigger \(Trigger\)”](#)
[“Trigger Source \(Source\),” “Trigger Slope \(Slope\)”](#)
[“Trigger Level \(Level\),” “Trigger Hysteresis \(Hysteresis\)”](#)

Waveform Acquisition Trigger Menu

1. On the waveform screen, tap **MENU > Acquire**. The Acquire menu appears.

For Scope Mode

2. Tap the **Trigger** tab > **Setting**, and select Simple.
3. Tap each item. Use the displayed list (options) or input box to set the items.

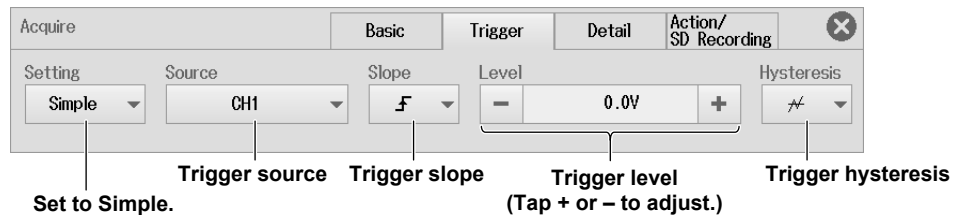

Trigger Source (Source)

4. Tap **Source**. Select the trigger source from the list (a context-sensitive list that varies depending on the installed module).

The displayed options vary depending on the installed module, waveform display on/off state, and waveform label settings. For CAN, CAN FD, LIN, and SENT, sub channel whose input (Input) is set to OFF cannot be selected.

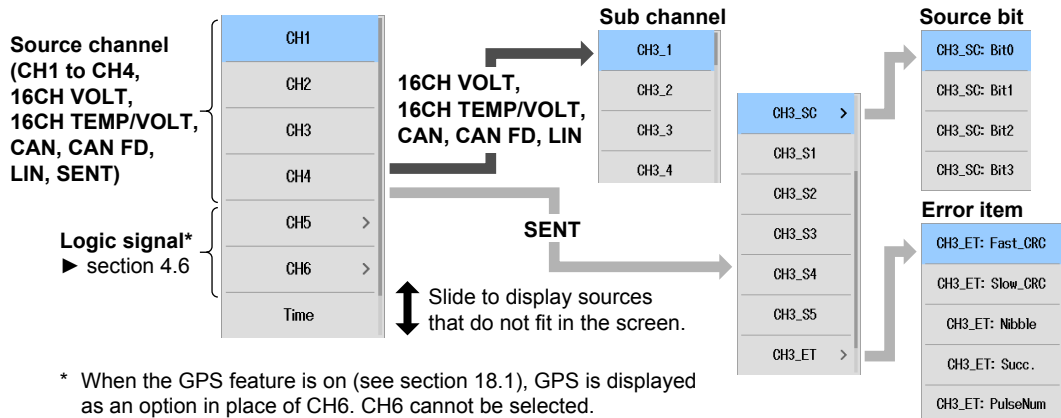

For Recorder Mode

2. Tap the **Detail** tab > **Type** in the Trigger area, and select Edge.
3. Tap each item in the Trigger area. Use the displayed list (options) or input box to set the items.

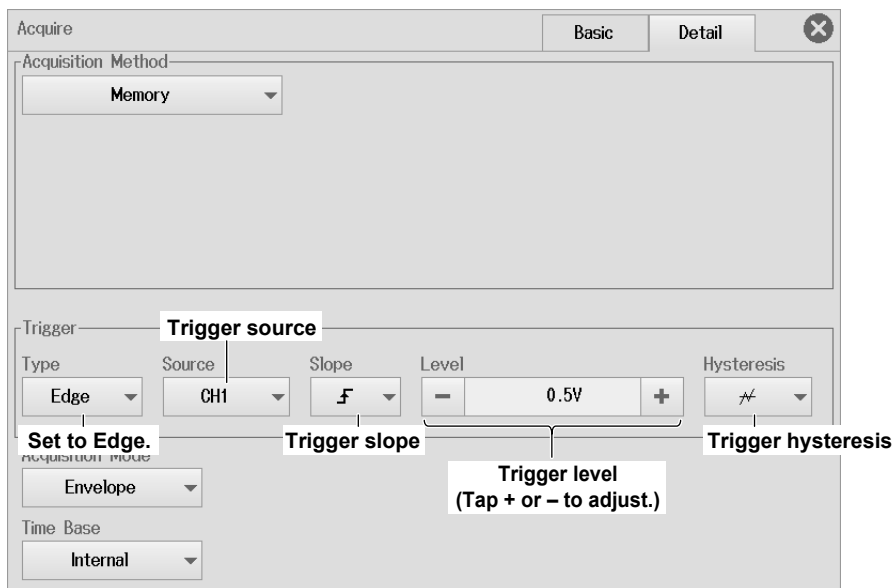

Trigger Source (Source)

- ▶ See the description on the previous page for scope mode.

4.4 Triggering on a Timer Trigger

This section explains the settings that are used when triggering on a specific date and time.

For Scope Mode

Setting the trigger to Simple, setting the trigger source to Time, date and time, time interval

For Recorder Mode

Setting the trigger type to Time, date and time

► [Features Guide: “Time \(Time\),” “Trigger Source \(Source\)”](#)

Waveform Acquisition Trigger Menu

1. On the waveform screen, tap **MENU** > **Acquire**. The Acquire menu appears.

For Scope Mode

2. Tap the **Trigger** tab > **Setting**, and select Simple.
3. Tap **Source**, and select Time.
4. Tap each item. Use the displayed list (options) or input box to set the items.

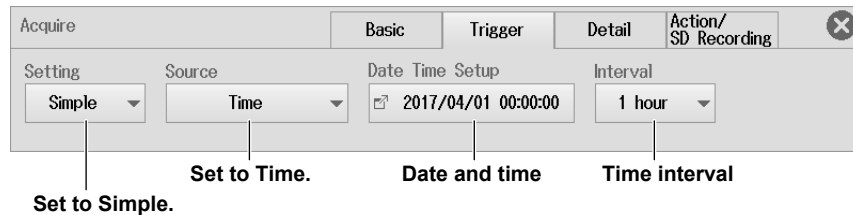

Date and Time (Date/Time Setup)

5. Tap **Date Time Setup**. The following screen appears.
6. Tap each item. Use the displayed list (options) or input box to set the items.

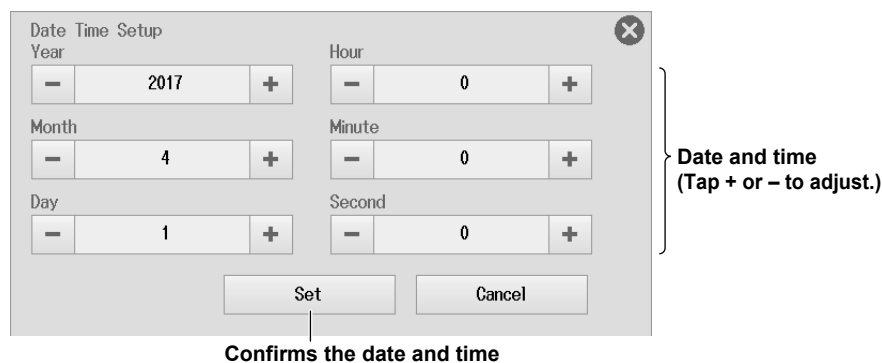

For Recorder Mode

2. Tap the **Detail** tab > **Type** in the Trigger area, and select Time.

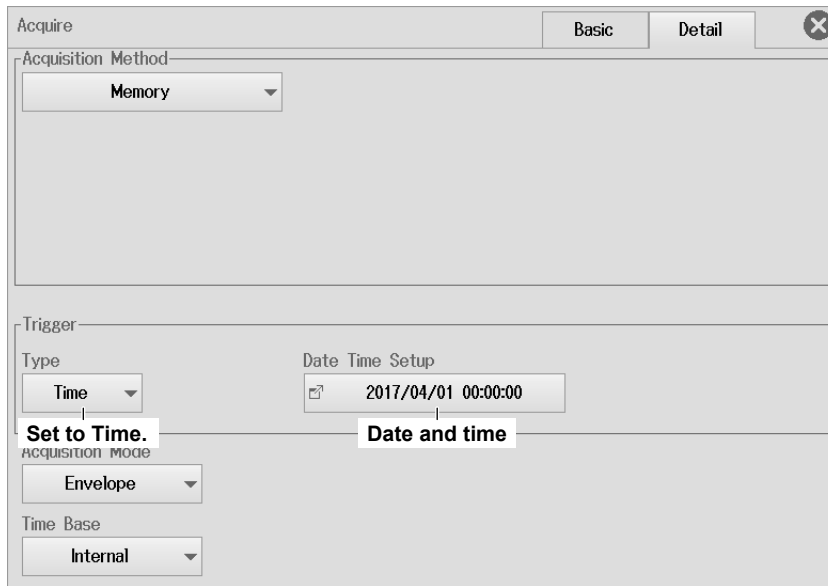

Date and Time (Date Time Setup)

- ▶ See the description on the previous page for scope mode.

4.5 Triggering on an External Trigger

This section explains the settings that are used when triggering on an external signal.

Applicable to Scope Mode

Setting the trigger to Simple, setting the trigger source to External, trigger slope

For Recorder Mode

Setting the trigger type to Edge, setting the trigger source to External, trigger slope

► [Features Guide: “External Signal \(External\),” “Trigger Source \(Source\)”](#)
[“Trigger Slope \(Slope\)”](#)

Waveform Acquisition Trigger Menu

1. On the waveform screen, tap **MENU** > **Acquire**. The Acquire menu appears.

For Scope Mode

2. Tap the **Trigger** tab > **Setting**, and select Simple.
3. Tap **Source**, and select External.
4. Tap **Slope**, and select the trigger slope.

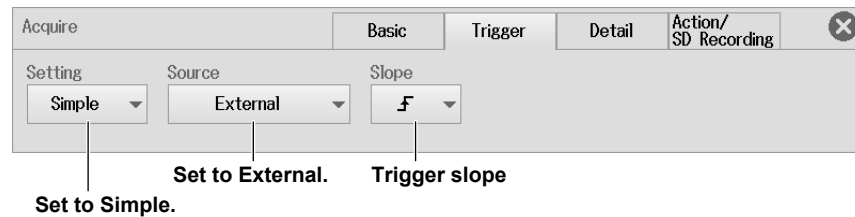

4.5 Triggering on an External Trigger

For Recorder Mode

2. Tap the **Detail** tab > **Type** in the Trigger area, and select Edge.
3. Tap **Source**, and select External.
4. Tap **Slope**, and select the trigger slope.

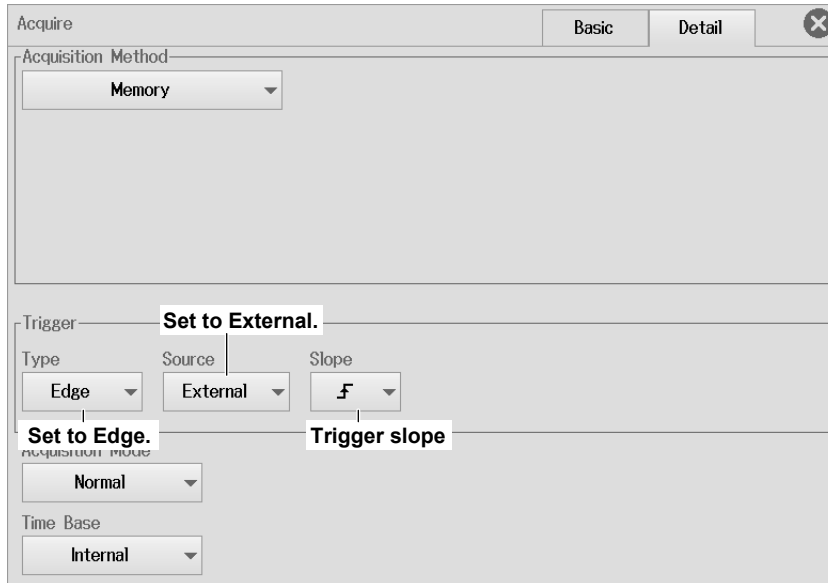

4.6 Triggering on an Edge Trigger of a Logic Signal

This section explains the following settings for triggering on the edges of a logic-signal trigger source:

For Scope Mode

Setting the trigger to Simple, trigger source, source bit, trigger slope

For Recorder Mode

Setting the trigger type to Edge, trigger source, source bit, trigger slope

► [Features Guide: “Simple \(Simple\),” “Trigger Source \(Source\)” “Trigger Slope \(Slope\)”](#)

Waveform Acquisition Trigger Menu

1. On the waveform screen, tap **MENU** > **Acquire**. The Acquire menu appears.

For Scope Mode

2. Tap the **Trigger** tab > **Setting**, and select Simple.
3. Tap **Slope**, and select the trigger slope.

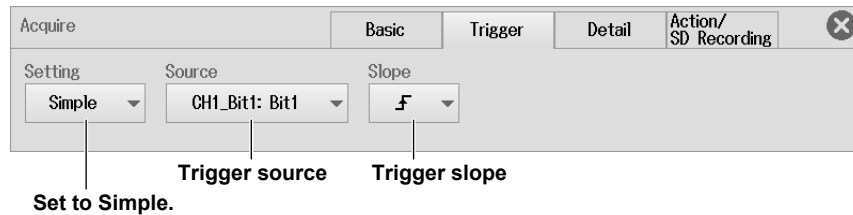

Trigger Source (Source)

4. Tap **Source**, and select a channel of the logic input module or CH5 or CH6. A list of source bits appears.
5. Tap the source bit you want to select.

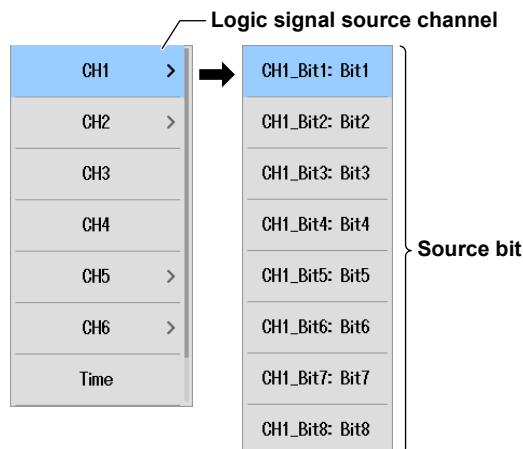

For Recorder Mode

2. Tap the **Detail** tab > **Type** in the Trigger area, and select Edge.
3. Tap **Slope**, and select the trigger slope.

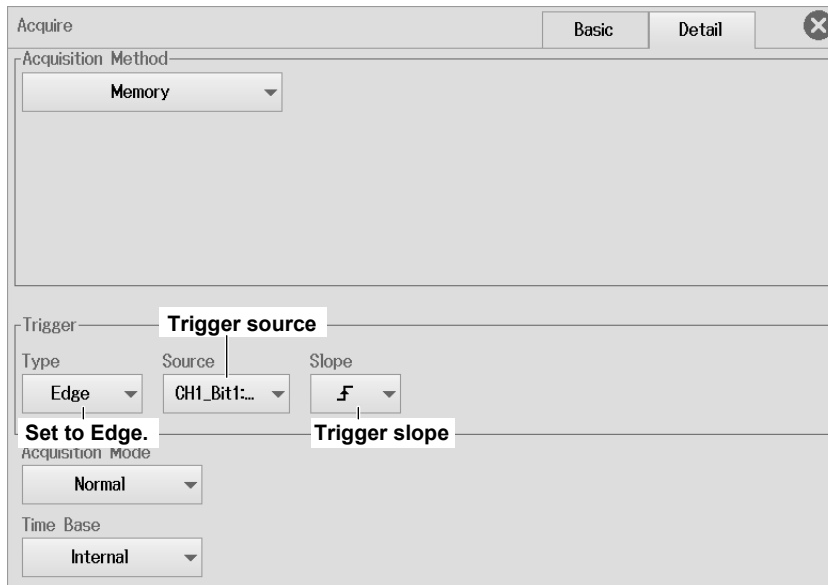

Trigger Source (Source)

- ▶ See the description on the previous page for scope mode.

4.7 Triggering on an Edge On A Trigger

This section explains the following settings for triggering on an Edge On A trigger.

Applicable to Scope Mode

Setting the trigger to Enhanced, setting the trigger type to Edge On A, state condition, edge detection condition, trigger condition, state condition achievement condition

These settings are not available in recorder mode.

► [Features Guide: “Edge On A Trigger \(Enhanced\)”](#)

Waveform Acquisition Trigger Menu

1. On the waveform screen, tap **MENU** > **Acquire**. The Acquire menu appears.
2. Tap the **Trigger** tab > **Setting**, and select Enhanced.
3. Tap **Type** and select Edge On A.

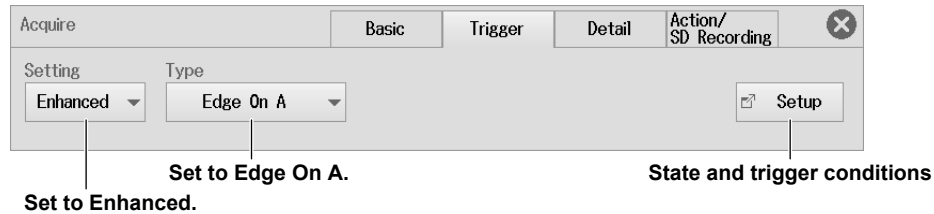

State Condition, Trigger Condition (Setup)

4. Tap **Setup**. The following screen appears.
5. Tap each item. Use the displayed list (options) or input box to set the items.

State condition (Select “X” to not use as a trigger source.)

Edge detection condition

Trigger level

	A State	Edge	Level	Hys
CH1	H	-	0.0V	≠
CH2	X	F	0.0V	≠
CH3	X	-	0.0V	≠
CH4	X	L	0.0V	≠
CH5	[+]			
CH6	[-]			
CH6_Bit1: Bit1	H	-		
CH6_Bit2: Bit2	L	-		
CH6_Bit3: Bit3	X	F		
CH6_Bit4: Bit4	X	-		

On a module with logic inputs or sub channels, expand the menu, and set each bit or sub channel.

Slide to display sources that do not fit in the screen.

4.8 Triggering on an OR Trigger

This section explains the following settings for triggering on an OR trigger.

For Scope Mode

Setting the trigger to Enhanced, setting the trigger type to OR, edge detection condition, trigger condition

For Recorder Mode

Setting the trigger type to OR, edge detection condition, trigger condition

► [Features Guide: “OR Trigger \(Enhanced\)”](#)

Waveform Acquisition Trigger Menu

1. On the waveform screen, tap **MENU > Acquire**. The Acquire menu appears.

For Scope Mode

2. Tap the **Trigger** tab > **Setting**, and select Enhanced.
3. Tap **Type** and select OR.

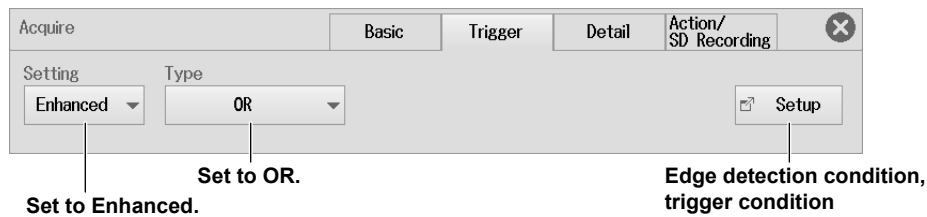

Edge Detection Condition, Trigger Condition (Setup)

4. Tap **Setup**. The following screen appears.
5. Tap each item. Use the displayed list (options) or input box to set the items.

Edge detection condition
(Select “—” to not use as a trigger source.)

Trigger level

Level width (when the edge detection condition is set to IN or OUT).

	Edge	Level	Width	Hys	Trigger hysteresis
CH1	F	0.0V	5.0V	≠	
CH2	T	0.0V	5.0V	≠	
CH3	IN	0.0V	5.0V	≠	
CH4	OUT	0.0V	5.0V	≠	
CH5	[+]				
CH6	[-]				
CH6_Bit1: Bit1	F				
CH6_Bit2: Bit2	T				
CH6_Bit3: Bit3	-				
CH6_Bit4: Bit4	-				

On a module with logic inputs or sub channels, expand the menu, and set each bit or sub channel.

Slide to display sources that do not fit in the screen.

For Recorder Mode

2. Tap the **Detail** tab > **Type** in the Trigger area, and select OR.

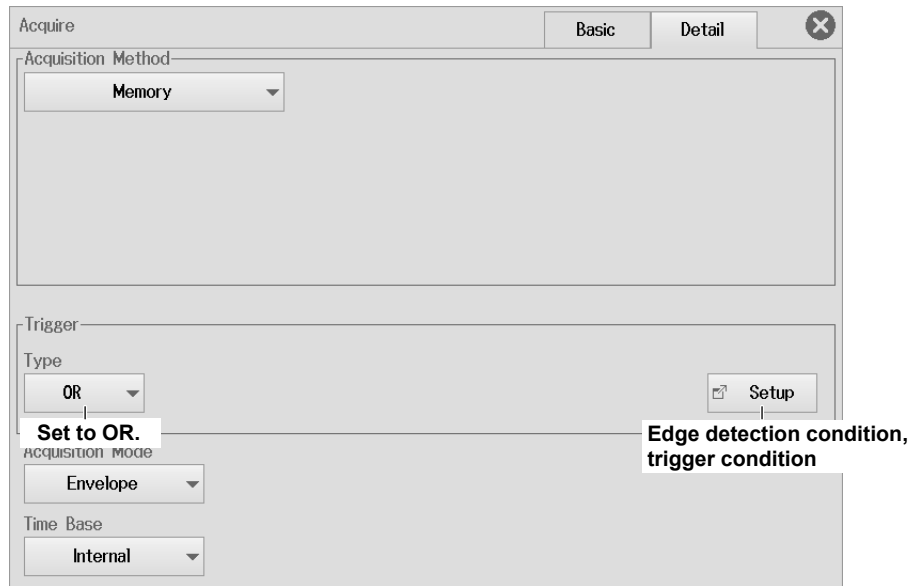

Edge Detection Condition, Trigger Condition (Setup)

- ▶ See the description on the previous page for scope mode.

4.9 Triggering on an AND Trigger

This section explains the following settings for triggering on an AND trigger.

For Scope Mode

Setting the trigger to Enhanced, setting the trigger type to AND, achievement condition, trigger condition

For Recorder Mode

Setting the trigger to AND, achievement condition, trigger condition

► [Features Guide: “AND Trigger \(Enhanced\)”](#)

Waveform Acquisition Trigger Menu

1. On the waveform screen, tap **MENU** > **Acquire**. The Acquire menu appears.

For Scope Mode

2. Tap the **Trigger** tab > **Setting**, and select Enhanced.
3. Tap **Type** and select AND.

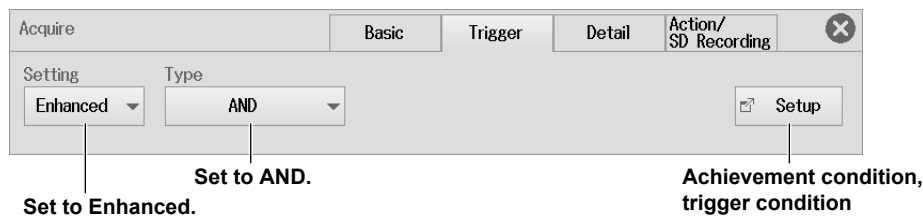

Achievement condition, Trigger Condition (Setup)

4. Tap **Setup**. The following screen appears.
5. Tap each item. Use the displayed list (options) or input box to set the items.

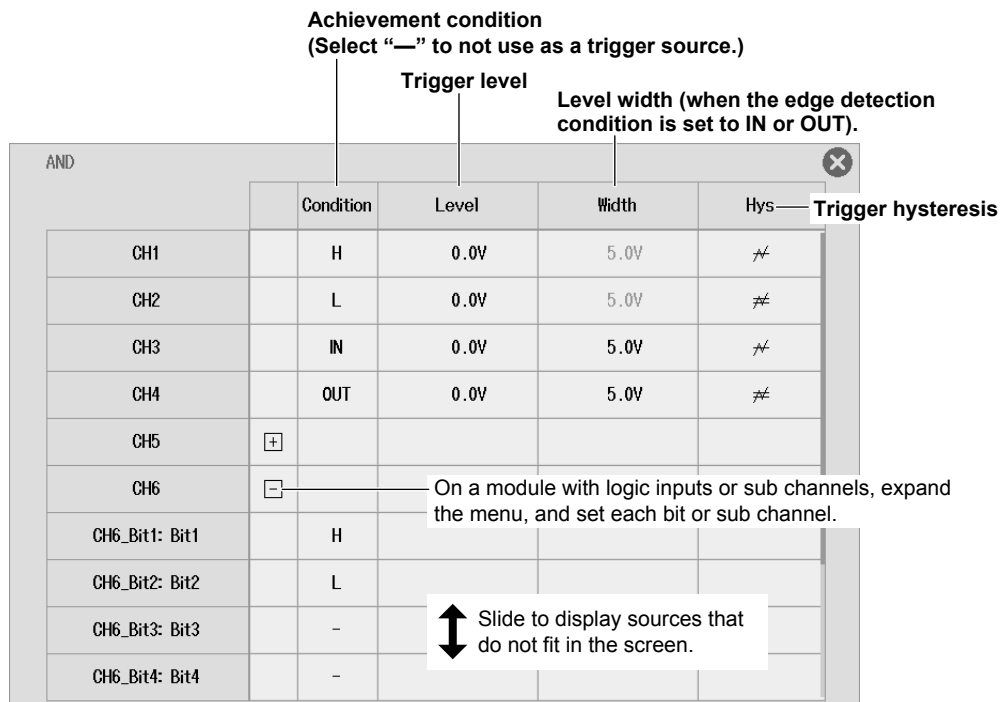

For Recorder Mode

2. Tap the **Detail** tab > **Type** in the Trigger area, and select AND.

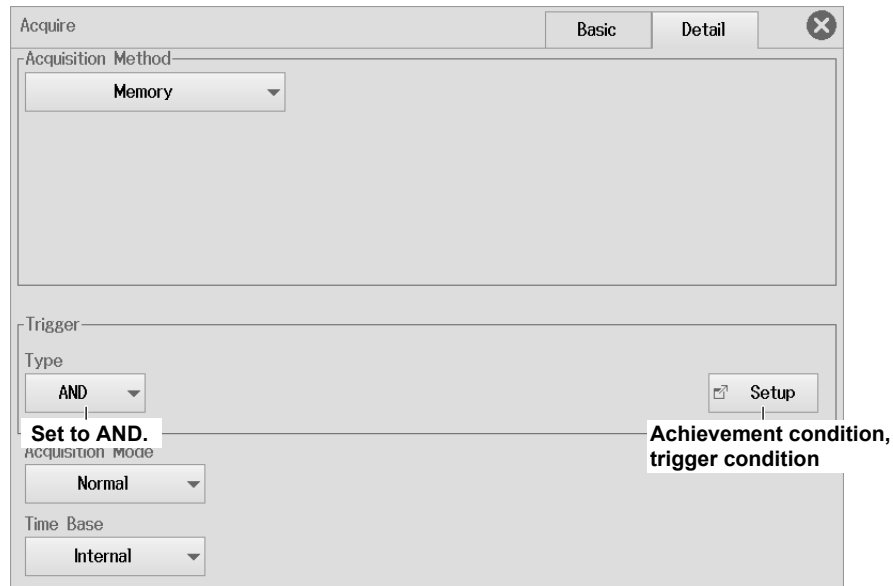

Achievement condition, Trigger Condition (Setup)

- ▶ See the description on the previous page for scope mode.

4.10 Triggering on a Period Trigger

This section explains the following settings for triggering on a period trigger.

Applicable to Scope Mode

Setting the trigger to Enhanced, setting the trigger type to Period, state condition, trigger condition, determination mode, reference time

These settings are not available in recorder mode.

► [Features Guide: “Period Trigger \(Enhanced\)”](#)

Waveform Acquisition Trigger Menu

1. On the waveform screen, tap **MENU > Acquire**. The Acquire menu appears.
2. Tap the **Trigger** tab > **Setting**, and select Enhanced.
3. Tap **Type** and select Period.

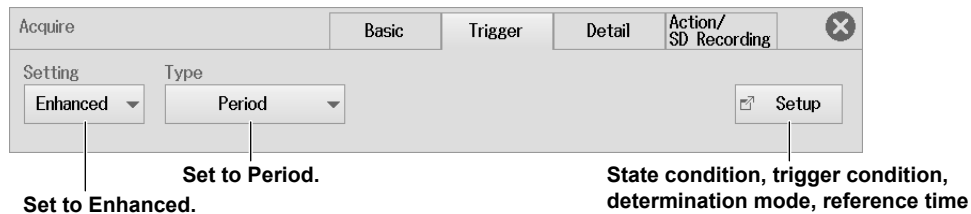

State Condition, Trigger Condition, Determination Mode, Reference Time (Setup)

4. Tap **Setup**. The following screen appears.
5. Tap each item. Use the displayed list (options) or input box to set the items.

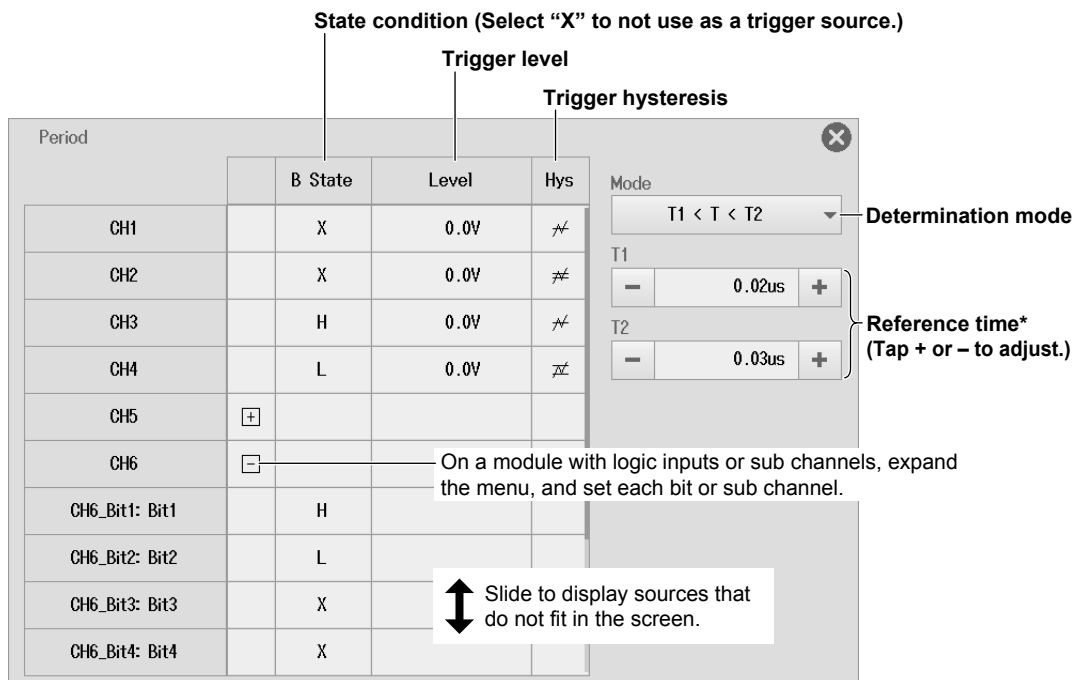

* Set T1 and T2 when the determination mode is T1 < T < T2 or T < T1, T2 < T. Set Time when the determination mode is T < Time or T > Time.

Determination Mode (Mode)

Set what kind of relationship must be established between period T and the specified reference times (Time or T1 and T2) for the instrument to trigger.

T < Time	Period T must be shorter than the reference time (Time).
T > Time	Period T must be longer than the reference time (Time).
T1 < T < T2	Period T must be longer than reference time T1 and shorter than reference time T2.
T < T1, T2 < T	Period T must be shorter than reference time T1 or longer than reference time T2.

4.11 Triggering on a Pulse Width Trigger

This section explains the following settings for triggering on a pulse width trigger.

Applicable to Scope Mode

Setting the trigger to Enhanced, setting the trigger type to Pulse Width, state condition, trigger condition, determination mode, reference time

These settings are not available in recorder mode.

► [Features Guide: “Pulse Width Trigger \(Enhanced\)”](#)

Waveform Acquisition Trigger Menu

1. On the waveform screen, tap **MENU > Acquire**. The Acquire menu appears.
2. Tap the **Trigger** tab > **Setting**, and select Enhanced.
3. Tap **Type** and select Pulse Width.

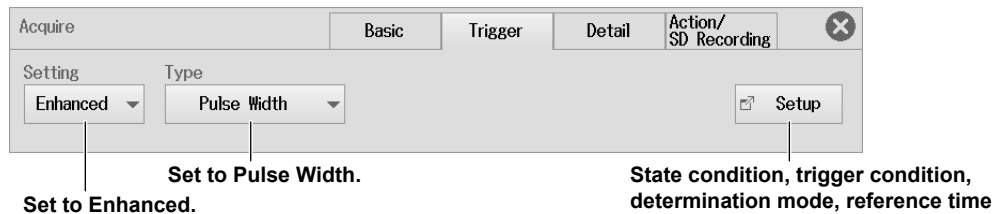

State Condition, Trigger Condition, Determination Mode, Reference Time (Setup)

4. Tap **Setup**. The following screen appears.
5. Tap each item. Use the displayed list (options) or input box to set the items.

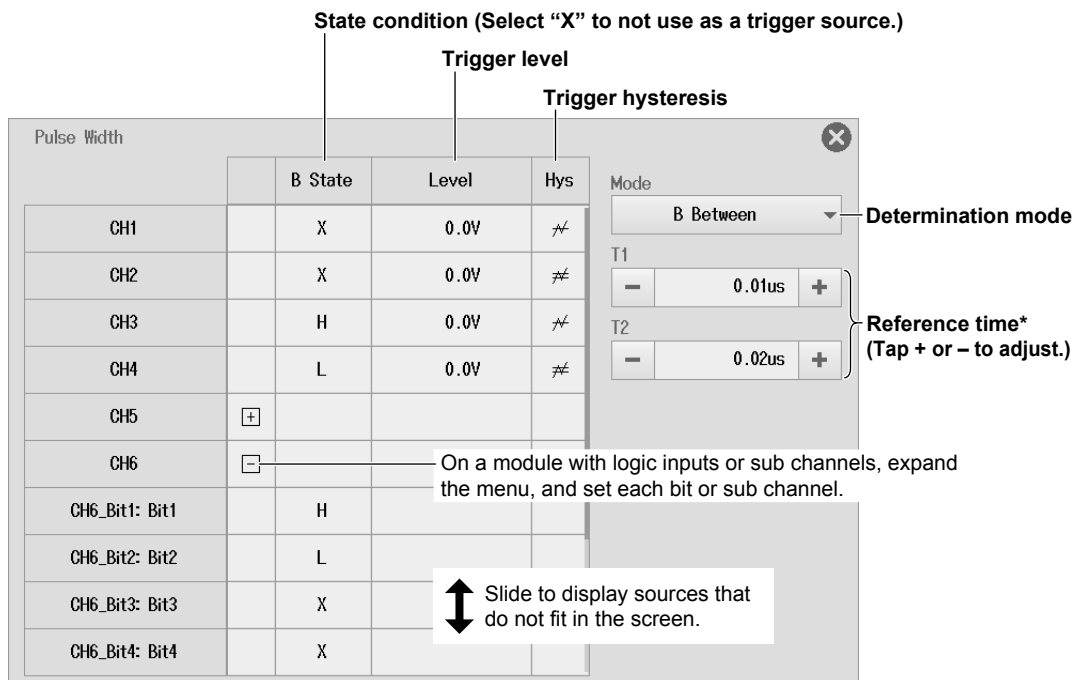

* Set T1 and T2 when the determination mode is B Between.
Set Time when the determination mode is B < Time, B >Time, or B TimeOut.

Determination Mode (Mode)

Set what kind of relationship must be established between the state condition B achievement time and the specified reference times (Time or T1 and T2) for the instrument to trigger.

B < Time	The instrument triggers when the achievement time is shorter than the reference time (Time), and the state condition changes from being met to not being met.
B > Time	The instrument triggers when the achievement time is longer than the reference time (Time), and the state condition changes from being met to not being met.
B TimeOut	The instrument triggers when the achievement time is longer than the reference time (Time).
B Between	The instrument triggers when the achievement time is longer than reference time T1 and shorter than reference time T2, and the state condition changes from being met to not being met.

4.12 Triggering on a Wave Window Trigger

This section explains the following settings for triggering on a wave window trigger.

Applicable to Scope Mode

Setting the trigger to Enhanced, setting the trigger type to Wave Window, source channel, tolerance, cycle frequency, reference cycle, sync channel, trigger condition

These settings are not available in recorder mode.

► [Features Guide: “Wave Window Trigger \(Enhanced\)”](#)

Waveform Acquisition Trigger Menu

1. On the waveform screen, tap **MENU** > **Acquire**. The Acquire menu appears.
2. Tap the **Trigger** tab > **Setting**, and select Enhanced.
3. Tap **Type** and select Wave Window.

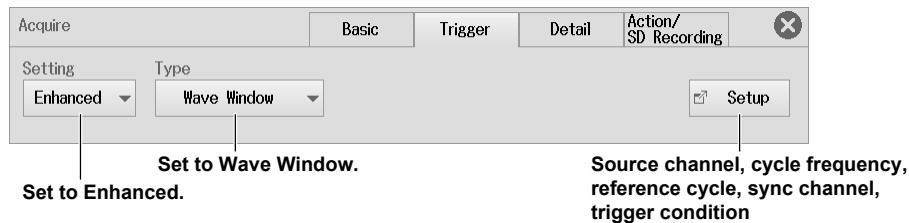

Source Channel, Cycle Frequency, Reference Cycle, Sync Channel, Trigger Condition (Setup)

4. Tap **Setup**. The following screen appears.
5. Tap each item. Use the displayed list (options) or input box to set the items.

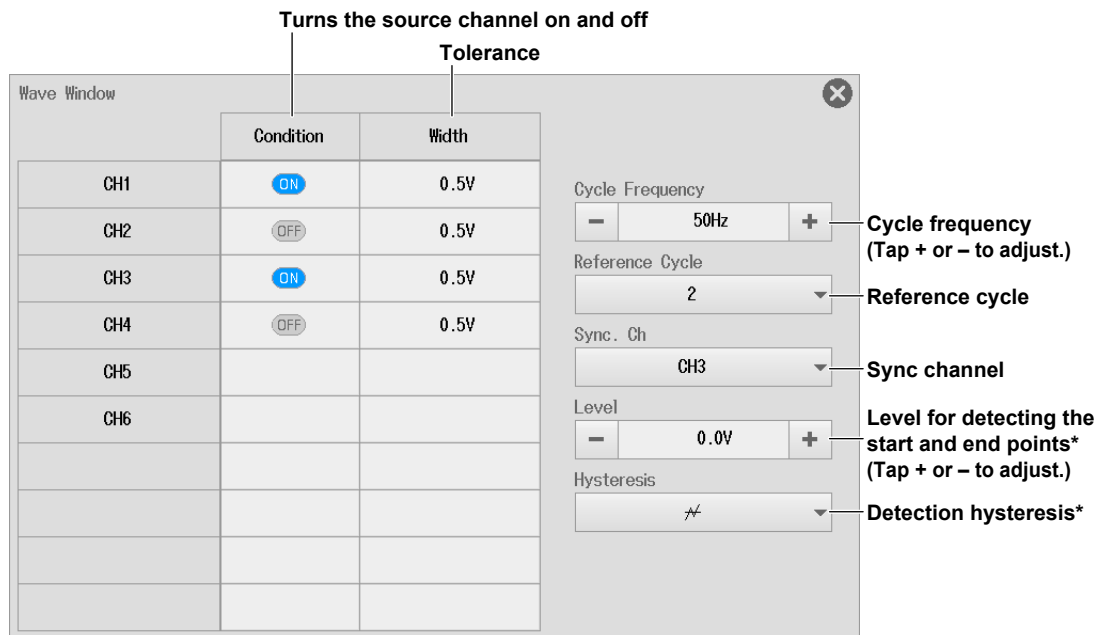

* Set when the sync channel is CH1 to CH4.

4.13 Triggering the Instrument Manually (Manual Trigger)

This section explains how to trigger the instrument manually.

Items Common to Scope Mode and Recorder Mode

TRIGGER key

► [Features Guide: “Trigger Settings \(Setting\)”](#)
[“Trigger \(Trigger\)”](#)

Press **TRIGGER** ().

5.1 Setting Display Groups and Display Format

This section explains the following settings for displaying waveforms.

Items Common to Scope Mode and Recorder Mode

Display group, display format (number of divided screens)

► [Features Guide: “Display Group \(Select Group\)”](#)
[“Display Format \(Format\)”](#)

Display Menu

1. On the waveform screen, tap **MENU** > **Display**. The Display menu appears.

For Scope Mode

2. Tap each item. Use the displayed list (options) to set the items.

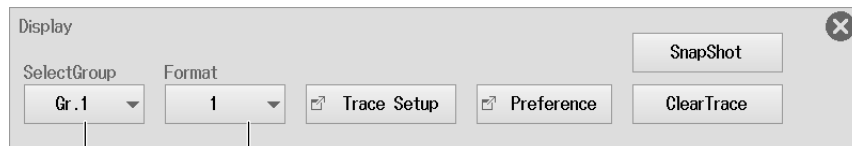

Display group

Display format

- Display format Group 1 can be selected when the display group is Gr.2 to Gr.4.
- This item is not available when the display group is DMM.

For Recorder Mode

2. Tap the **Basic** tab.
3. Tap each item. Use the displayed list (options) to set the items.

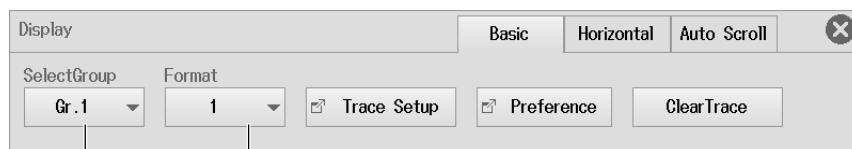

Display group

Display format

- Display format Group 1 can be selected when the display group is Gr.2 to Gr.4.
- This item is not available when the display group is DMM.

5.2 Setting the Waveform Arrangement, Color, and Grouping

This section explains the following settings for displaying waveforms.

Items Common to Scope Mode and Recorder Mode

Waveform arrangement, color, and grouping

► [Features Guide: “Waveform Arrangement, Color, and Grouping \(Trace Setup\)”](#)

Display Menu

1. On the waveform screen, tap **MENU > Display**. The Display menu appears.

For Scope Mode

2. Tap **Trace Setup**.

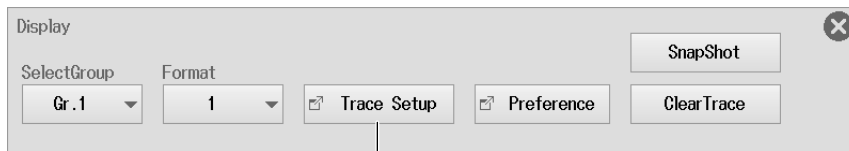

Waveform arrangement, color, and grouping

Waveform arrangement, color, and grouping

3. Tap the display group tab you want to group.
4. Tap each item. Use the displayed list (options) or input box to set the items.

Clears all the settings of the selected display group

Display group tab

The screenshot shows the 'Trace Setup' screen with a 'Gr. 1 Clear' button and 'Auto Grouping' and 'Mapping Mode' (set to 'Auto') options. Below is a table with columns for channel number (#), channel name (CH), and color. The table is divided into four sections for Gr. 1, Gr. 2, Gr. 3, and Gr. 4, plus a DMM section. A 'Mapping list' box highlights the table content. A note states: 'Automatically reassigns just the waveforms whose displays are turned on'. A legend at the bottom left shows a color swatch and the text 'Color Waveform to assign'.

#	CH	Color	#	CH	Color	#	CH	Color
1	CH1	Red	12			25		
2	CH2	Green	13			26		
3	CH3	Blue	14	-	-	27		
4	CH4	Purple	15			28		
5	CH5	Brown	16			29		
6	CH6	Orange	17			30		
7	Math1	Red	18			31		
8	Math2	Green	19			32		
9	-	-	20					
10	-	-	21					
11	-	-	22					

Color Waveform to assign Screen assignment of each waveform
When the mapping mode is set to User, set how to map each waveform to the divided screens.

For Recorder Mode

2. Tap the **Basic** tab.
3. Tap **Trace Setup**.

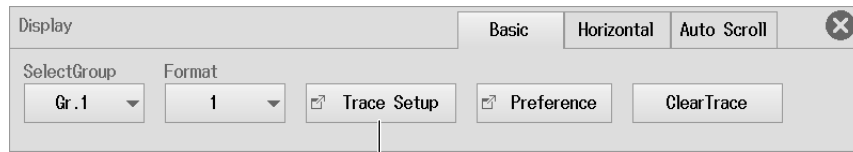

Waveform arrangement, color, and grouping

Waveform arrangement, color, and grouping

- ▶ See the description on the previous page for scope mode.

5.3 Configuring the Display Preferences

This section explains the waveform information and preference settings for displaying waveforms.

Items Common to Scope Mode and Recorder Mode

- Waveform data (interpolation method, decimation, accumulation, manual event)
- Information (scale value, horizontal axis display mode, font size, trace label, level indicator)
- Window (grid, extra window, display ratio of main window, window layout)
- Intensity (grid, cursor, marker)

► [Features Guide: “Environment Settings \(Preference\)”](#)

Display Menu

1. On the waveform screen, tap **MENU > Display**. The Display menu appears.

For Scope Mode

2. Tap **Preference**.

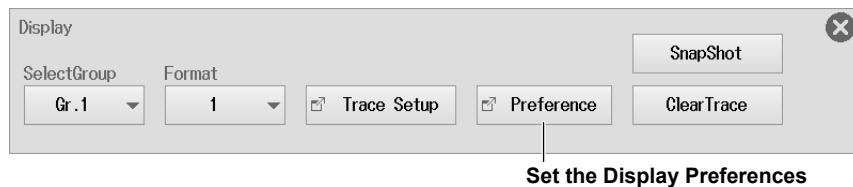

Setting the Display Preferences

- **Waveform data**

3. Tap the **WaveForm** tab.
4. Tap each item. Use the displayed list (options) or **ON/OFF** to set the items.

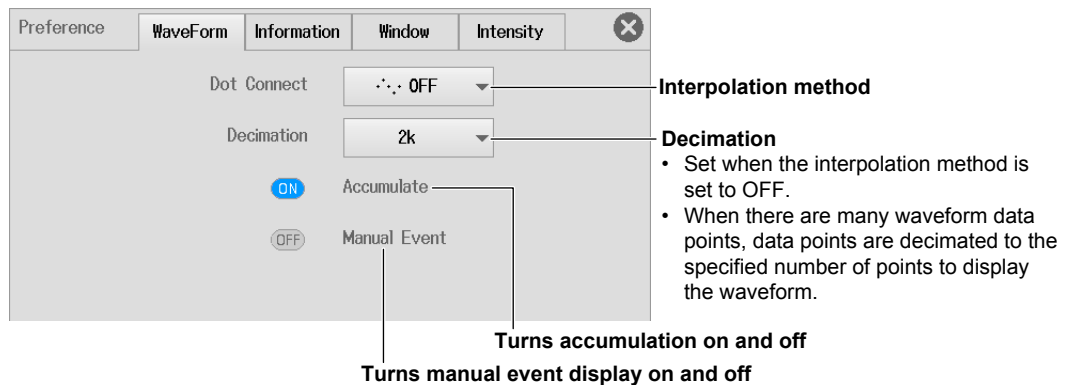

• **Information**

3. Tap the **Information** tab.
4. Tap each item. Use the displayed list (options) or **ON/OFF** to set the items.

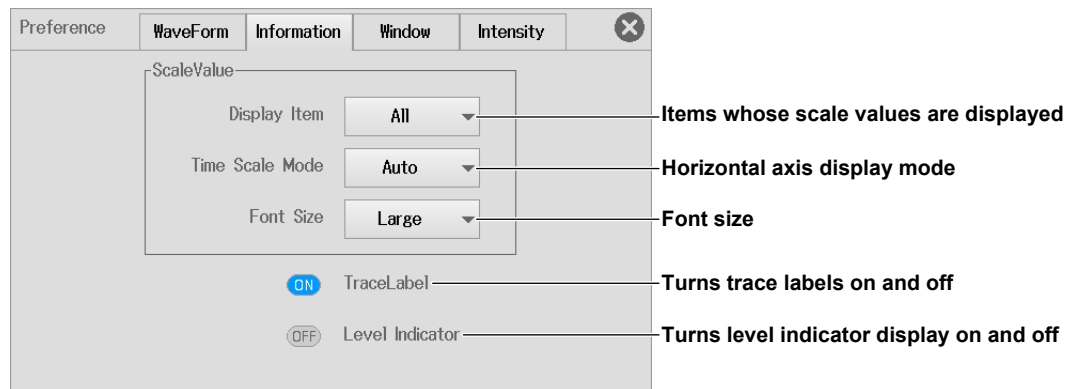

• **Window**

3. Tap the **Window** tab.
4. Tap each item. Use the displayed list (options) to set the items.

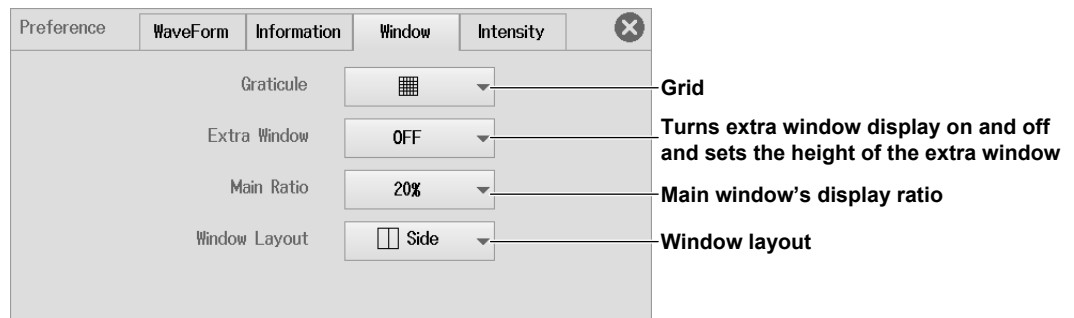

• **Intensity**

3. Tap the **Intensity** tab.
4. Tap each item. Use the displayed input box to set the items.

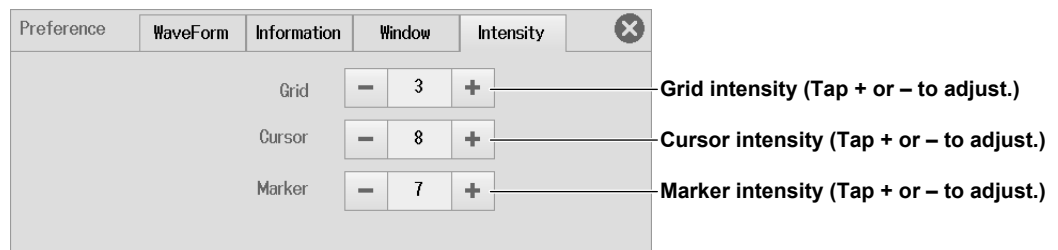

5.3 Configuring the Display Preferences

For Recorder Mode

2. Tap the **Basic** tab.
3. Tap **Preference**.

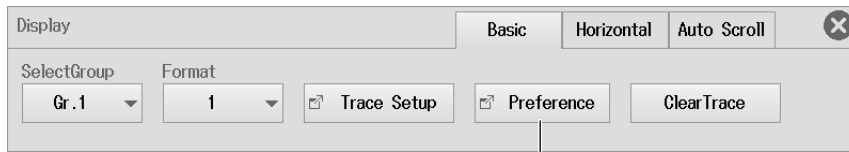

Display preferences

Configuring the Display Preferences

- ▶ See the description on the previous two page for scope mode.

The Accumulate on/off setting is not available in recorder mode.

5.4 Using the Snapshot and Clear Trace Features

This section explains how to take snapshots and clear traces.

For Scope Mode

- Snapshot
- Clear trace

For Recorder Mode

Clear trace

(The snapshot feature is not available in recorder mode.)

► [Features Guide: “Snapshot \(SnapShot\)”](#)
[“Clear Trace \(Clear Trace\)”](#)

Display Menu

1. On the waveform screen, tap **MENU > Display**. The Display menu appears.

For Scope Mode

Snapshot

2. Tap **SnapShot**.

Clear trace

2. Tap **Clear Trace**.

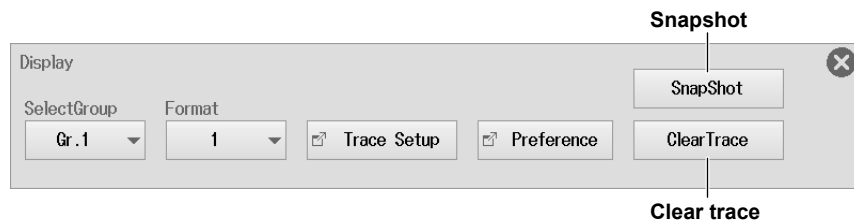

For Recorder Mode

Clear trace

2. Tap the **Basic** tab.
3. Tap **Clear Trace**.

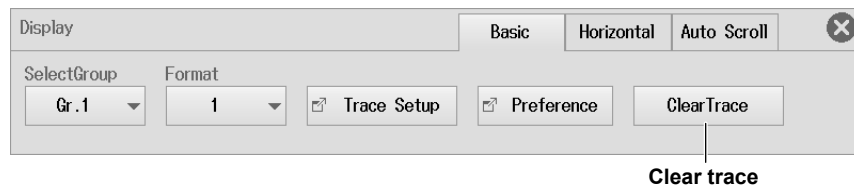

5.5 Setting the Display Time and Display Position

This section explains the following settings for displaying acquired waveforms.

Applicable to Recorder Mode

Display time, display position

These settings are not available in scope mode.

► [Features Guide: “Horizontal Scale \(Horizontal\)”](#)

Display Menu

1. On the waveform screen, tap **MENU > Display**. The Display menu appears.
2. Tap the **Horizontal** tab.
3. Tap each item. Use the displayed list (options) or input box to set the items.

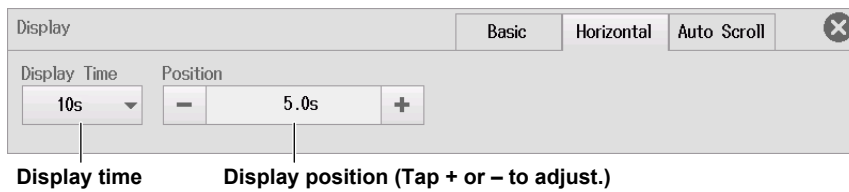

5.6 Auto Scrolling the Display Range

This section explains the following settings for auto scrolling the display range.

Applicable to Recorder Mode

Scroll direction, jumping to the left or right edge, scroll speed

These settings are not available in scope mode.

► [Features Guide: “Auto Scrolling \(Auto Scroll\)”](#)

Display Menu

1. On the waveform screen, tap **MENU** > **Display**. The Display menu appears.
2. Tap the **Auto Scroll** tab.
3. Tap the appropriate buttons. The display range scrolls according to the buttons you tap.
To change the scroll speed, tap the **Speed** value. Use the displayed input box to set the scroll speed.

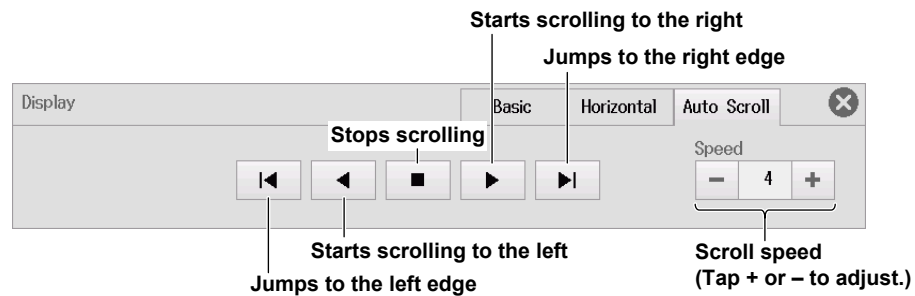

6.1 Connecting a Storage Device

This section explains the following settings for connecting to a storage device.

Items Common to Scope Mode and Recorder Mode

SD memory card, USB storage device

SD Memory Card



CAUTION

- Do not insert the SD memory card in the wrong direction. Doing so may damage the SD memory card and the instrument.
- Inserting and removing the SD memory card quickly (within the span of a second) may damage the instrument.
- Removing the SD memory card from the instrument while the card is being accessed may corrupt the data on the SD memory card. Be sure to close the SD memory card drive cover.
- An icon  appears at the top center of the screen when the SD memory card is being accessed.

French



ATTENTION

- Ne pas insérer la carte mémoire SD dans le mauvais sens. Cela pourrait endommager la carte mémoire SD ainsi que l'instrument.
- L'insertion et le retrait rapides de la carte mémoire SD (en l'espace d'une seconde) pourrait endommager l'instrument.
- Le retrait de la carte mémoire SD de l'instrument alors qu'une personne est en train d'y accéder pourrait corrompre les données de la carte mémoire SD. Veiller à fermer le clapet du lecteur de la carte mémoire SD.
- Une icône  apparaît en haut au centre de l'écran lorsqu'une personne est en train d'accéder à la carte mémoire SD.

Compatible SD Memory Cards

You can use memory cards that conform to the SD or SDHC standard with the instrument. For details, contact your nearest YOKOGAWA dealer.

This instrument shows the installation status of an SD memory card at the top of the screen.

When an SD memory card is installed: 

When an SD memory card is not installed: 

Note

- When using an SD memory card with a PC, make sure that the PC is compatible with the SD memory card. Also, depending on the type of PC, some of the SD cards listed above may not function properly. Check it in advance.
- We recommend you test the operation of the SD memory card once before saving data to it. Further, when you want to save important data, format the SD memory card first.
- If file operations (save, copy, move, delete, etc.) are performed repeatedly on the SD memory card, file access may slow down. If this occurs, format the SD memory card, or replace with a new one.

How to Insert an SD Memory Card

1. Slide the SD memory card drive cover. The SD memory card drive is on the left side panel of the instrument.
2. Insert the SD memory card into the slot with the front of the card facing the front panel. If you are using an SD memory card that has a write-protection feature and you want to save data to or format the card, disable the write-protection feature before you insert the SD memory card into the instrument.
3. Slide the SD memory card drive cover. Slide until you hear it click.

SD memory card drive cover

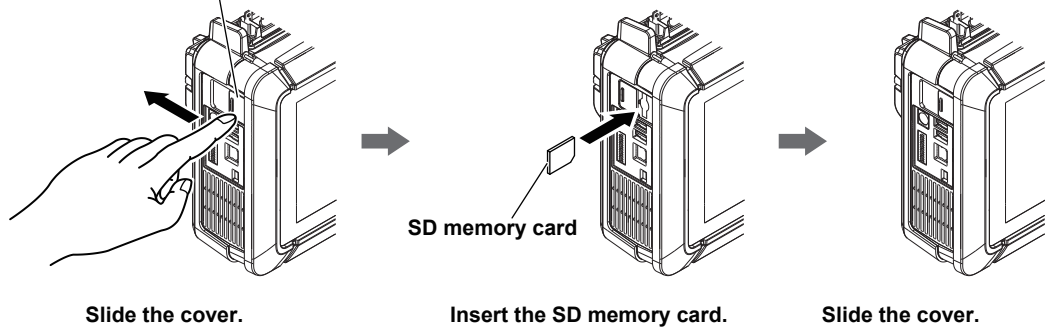

Removing the SD Memory Card

1. Slide the SD memory card drive cover.

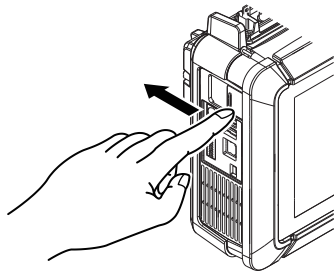

2. Push the SD memory card with your finger and release to eject the card. Remove the SD memory card.

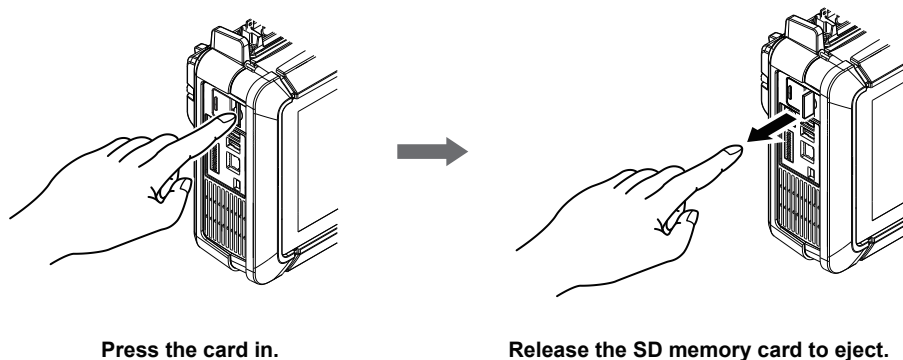

General SD Memory Card Handling Precautions

Follow the general handling precautions that are provided with your SD memory card.

USB Storage Device

CAUTION

- Do not remove the USB storage device or turn off the power when the medium is being accessed. If you do so, the data on the USB storage device may be corrupted.
- An icon  appears at the top center of the screen when the USB storage device is being accessed.

French

ATTENTION

- Pendant que le dispositif accède au support de stockage USB, ne retirez pas ce dernier et ne mettez pas l'alimentation hors tension. Vous risqueriez d'endommager les données sur le support de stockage USB.
- Une icône  au centre de la partie supérieure de l'écran indique que le dispositif est en train d'accéder au support de stockage USB.

Compatible USB Storage Devices

You can use USB storage devices that are compatible with USB Mass Storage Class version 1.1.

Note

- Only connect a USB keyboard, USB mouse, USB printer, or USB storage device to the USB connector for peripherals.
- The instrument can handle up to four storage devices. If the connected device is partitioned, the instrument treats each partition as a separate storage device.
- Connect USB storage device directly, not through a USB hub.
- Do not connect and disconnect the two USB devices repetitively. Provide at least a 10-second interval between removal and connection.

How to Connect a USB Storage Device

When connecting a USB storage device to the instrument's USB port, connect the USB cable directly as shown in the figure below. You can connect/disconnect a USB cable at any time regardless of whether the instrument is on or off (hot-plugging is supported). Connect the type A connector of the USB cable to the instrument, and connect the type B connector to the USB storage device. If you connect a USB storage device when the power switch is on, the device becomes available for use after the instrument identifies it.

The instrument has two USB ports: USB-0 and USB-1. The port numbers are not fixed. The port at which the first USB storage device is detected becomes USB-0. The second detected USB storage device becomes USB-1.



General USB Storage Device Handling Precautions

Follow the general handling precautions that are provided with your USB storage device.

6.2 Formatting an SD Memory Card

This section explains the following settings for formatting the SD memory card.

Items Common to Scope Mode and Recorder Mode

Formatting an SD memory card

► [Features Guide: “System Configuration \(System Configuration\)”](#)

CAUTION

- When you format an SD memory card, all the data saved in the card will be erased.
- If a formatted SD memory card cannot be detected by the instrument, use the instrument to format it again.

French

ATTENTION

- Lorsque vous formatez un support de la carte mémoire SD, toutes les données qu'il contient sont supprimées.
- Si le l'instrument ne détecte pas un support de la carte mémoire SD formaté, utilisez le l'instrument pour formater de nouveau le support de la carte mémoire SD.

Utility System Menu

1. On the waveform screen, tap **MENU > Utility > System**. A System screen appears.

Formatting an SD Memory Card (SD Card Format)

2. Tap the **Others** tab.
3. Tap **Execute Format** to execute.

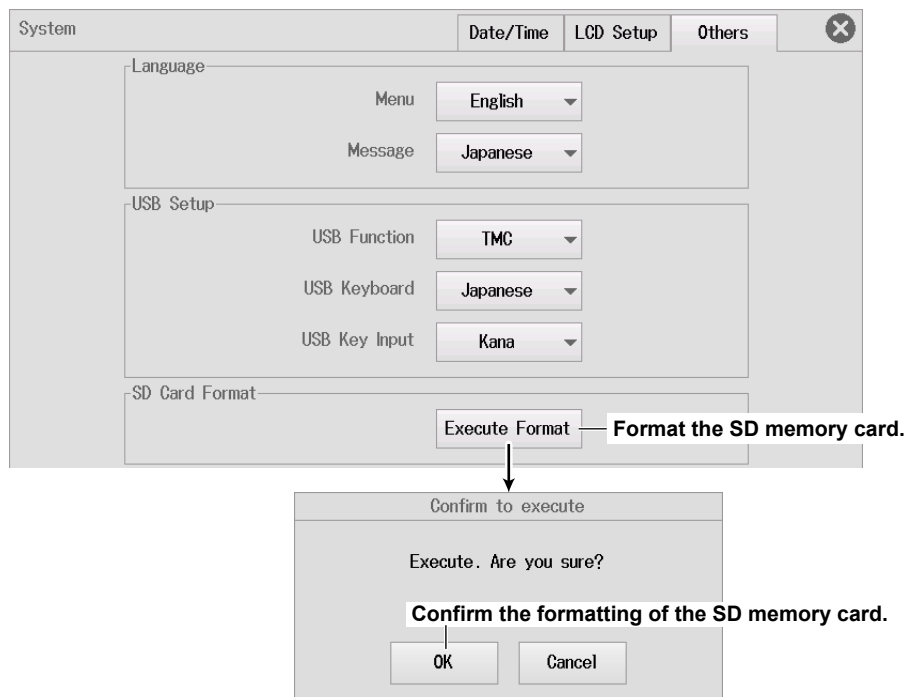

6.3 Saving Waveform Data

This section explains the following settings for saving waveform data):

Items Common to Scope Mode and Recorder Mode

Save destination, file name, data format, save range, waveform to save, saving waveform data

► [Features Guide: “Saving Waveform Data \(Waveform Save\)”](#)

Save/Load Waveform Save Menu

1. On the waveform screen, tap **MENU > Save/Load > Waveform Save**. A Waveform Save menu appears.
2. Tap each item. Use the displayed input box to set the items.



Setting the File Name (FileName Setup)

3. Tap **FileName Setup**. A Setup menu appears.
 - * The set path name appears.
4. Tap each item. Use the displayed list (options) or input box to set the items.

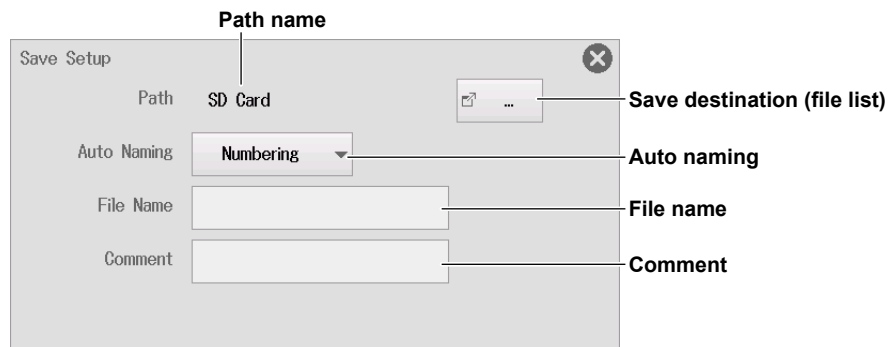

6.3 Saving Waveform Data

Save Destination (File List)

5. Tap . The following screen appears.
6. Set the waveform data save destination (device/folder).

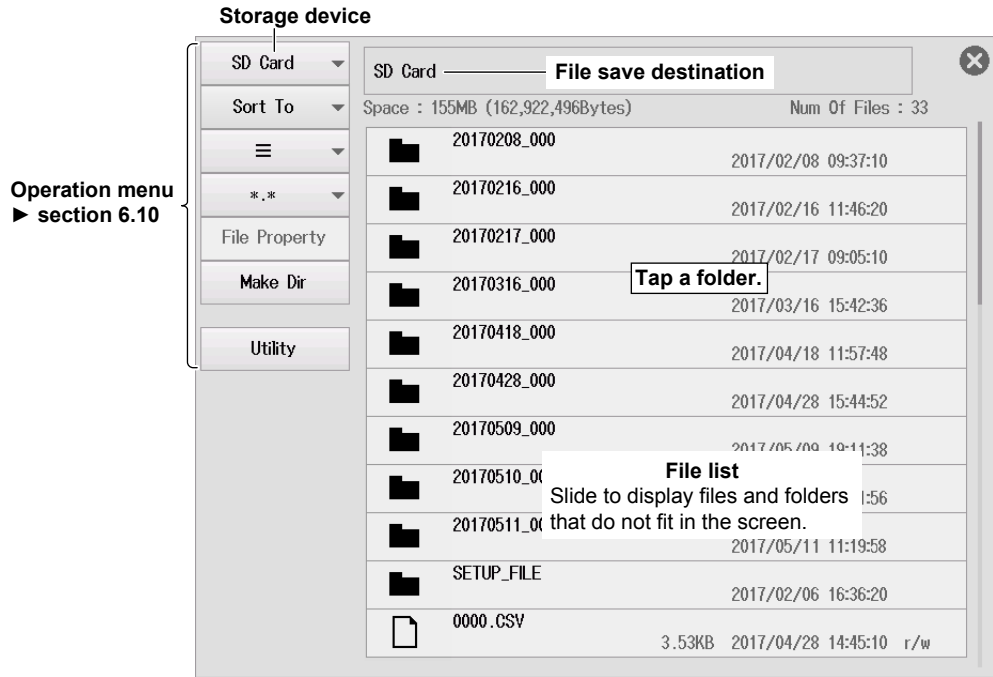

Auto Naming (Auto Naming)

OFF: The auto naming feature is disabled. The name that you specify using the File Name setting is used. If there is a file with the same name in the save destination folder, you cannot save the data.

Numbering: The instrument automatically adds a four-digit number (0000 to 9999) after the common name specified using the File Name setting (up to 32 characters).

Date: The file name is the date and time (down to ms) when the file is saved. The file name specified using the File Name setting is not used.

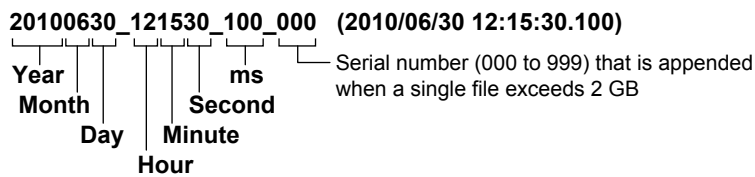

Regardless of whether the auto naming feature is set to OFF, Numbering, or Date, if the data size of a single file exceeds 2 GB, an underscore and a three-digit sequence number (000 to 999) is appended to the file name. The sequence number is incremented by one each time a file is added. This is appended only if the file exceeds 2 GB.

However, when a file is saved through the SD recording feature, an underscore and the three-digit serial number are appended to the file name even if the file size does not exceed 2 GB.

Comment (Comment)

You can add a comment that consists of up to 120 characters when you save a file. You do not have to enter a comment. All characters, including spaces, can be used in comments.

Waveform Save Conditions (Waveform Save Setup)

3. Tap **Waveform Save Setup**. A Waveform Save Setup menu appears.

Basic Setup (Basic)

4. Tap the **Basic** tab. The following screen appears.
5. Tap each item. Use the displayed list (options) or input box to set the items.

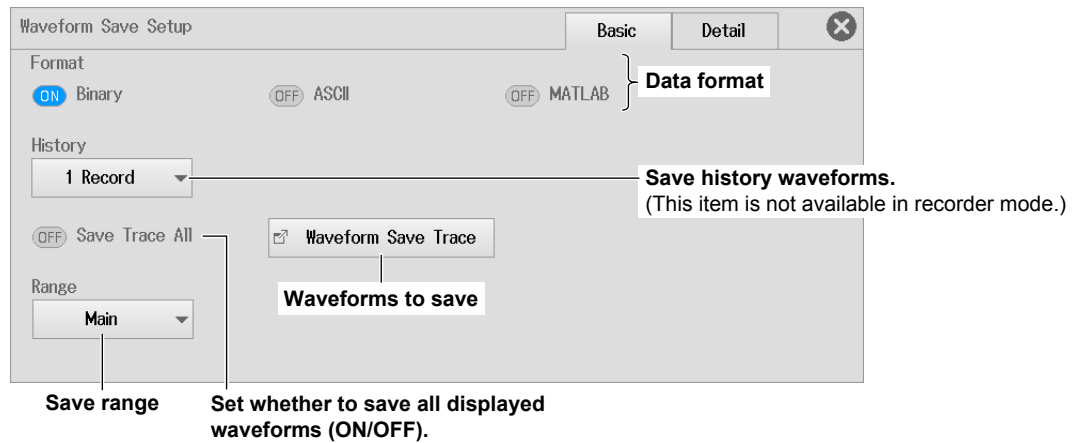

- **Data Format (Format)**

You can save the sampling data stored in the acquisition memory in the following data formats.

Data Format	Extension	
Binary	.WDF	Data is saved in binary format. You can load this type of data into the instrument. ► section 6.7
ASCII	.CSV	Data is scaled using the specified range and saved to a file in ASCII format. You cannot load this type of data into the instrument.
MATLAB	.MAT	Data is saved in MATLAB format. You cannot load this type of data into the instrument.

- **Saving History Waveforms (History)**

Set this item for scope mode.

1 Record: The one waveform that is selected with Select Record on the History menu will be saved.

All Record: All waveforms within the range bounded by Start Record and End Record on the History menu will be saved.

* If the data type is set to MATLAB, a single waveform (1 record) selected with Select Record from the History menu is saved, regardless of the 1 Record or All Record setting.

Note

Average waveforms of history waveforms cannot be saved. Save the necessary range of history waveforms using All Record, load the saved history waveforms, and then select Average Record from the History menu to display the average waveform.

6.3 Saving Waveform Data

- **Waveforms to Save (Waveform Save Trace)**

6. Tap **Waveform Save Trace**. The following screen appears.

7. Tap each item to set options.



Set whether to save the specified waveforms (ON/OFF).

- You can select CH1 to CH6, 16CH VOLT, 16CH TEMP/VOLT, CAN, CAN FD, LIN, SENT, and Math waveforms. The waveforms you select that are displayed are saved.
- In scope mode, if you set History to All Record, Math waveforms will not be saved. If you want to save the Math data, set History to 1 Record.
If you set History to All Record, all history waveforms within the range bounded by Start Record and End Record on the History menu will be saved. If you want to select which waveform will be saved, do not select All Record.

- **Save Range (Range)**

You can select the waveform save range (area) from one of the choices below.

- Scope mode

Main: The normal waveform range. Waveforms are saved up to the displayed record length (the range that is displayed on the screen).

Zoom1: The range of zoom waveform Zoom1.

Zoom2: The range of zoom waveform Zoom2.

Cursor Range: The range that is bounded by Cursor1 and Cursor2.

- Recorder mode

All: The entire range during the acquisition time.

Display area: The range shown in the waveform display window.

Zoom: The range shown in the zoom window.

Cursor: The range specified with cursors.

Detail Settings (Detail)

4. Tap the **Detail** tab. The following screen appears.
5. Tap each item. Use the displayed list (options) or input box to set the items.

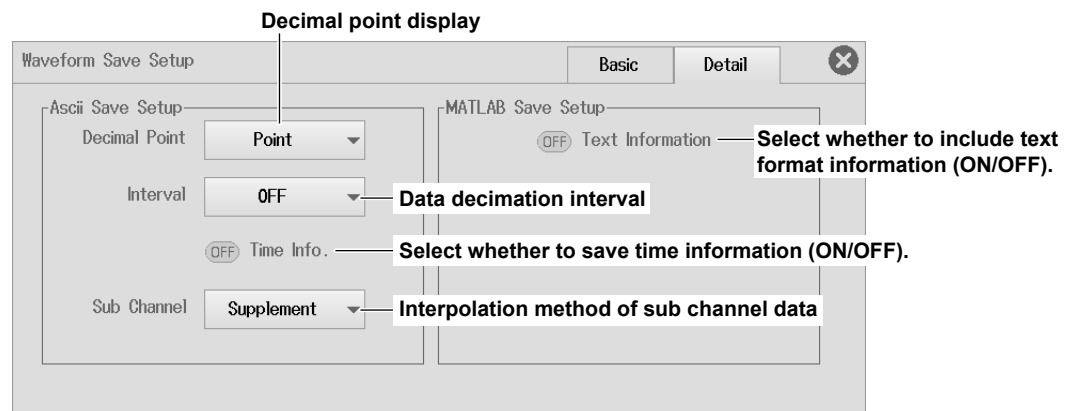

- **Decimal Point (Decimal Point)**

When you save data in ASCII format, you can choose how to separate the data.

Point (Point): The decimal point is a period, and the separator is a comma.

Comma (Comma): The decimal point is a comma, and the separator is a period.

- **Data Removal Interval (Interval)**

When you save data in ASCII format, you can thin out the data before you convert it to ASCII format. Set the data removal interval.

OFF (no data is removed), 5 points (Per 5), 10 points (Per 10), 20 points (Per 20), 50 points (Per 50), 100 points (Per 100), 200 points (Per 200), 500 points (Per 500), 1000 points (Per 1000), 2000 points (Per 2000), 5000 points (Per 5000)

For example, if you select Per 5, the data will be removed as indicated below.

First data point, +5, +10, +15...

- **Time Information (Time Info.)**

When you save data in ASCII format, you can choose whether to save time information (ON/OFF).

- **Interpolation Method of Sub Channel Data (Sub Channel)**

When you save data in ASCII format, you can choose how to interpolate the sub channel data of 16-CH voltage input, 16-CH temperature/voltage input, CAN bus monitor, CAN/CAN FD monitor, CAN & LIN bus monitor, and SENT monitor modules.

Supplement (Supplement): Blank spaces are filled with repetitions of the same data so that the sub channels have the same amount of data as an ordinary channel.

Space (Space): Spaces are left where there is no data.

- **MATLAB Save Settings (MATLAB Save Setup)**

You can select whether to include text format information (ON) or not (OFF).

6.4 Saving Setup Data

This section explains the following settings for saving setup data. You can save setup data to a file.

Items Common to Scope Mode and Recorder Mode

Save destination, file name, saving setup data

► [Features Guide: “Saving Setup Data \(Setup Save\)”](#)

Save/Load Setup Save Menu

1. On the waveform screen, tap **MENU > Save/Load > Setup Save**. A Setup Save menu appears.
2. Tap each item to set options and execute commands.

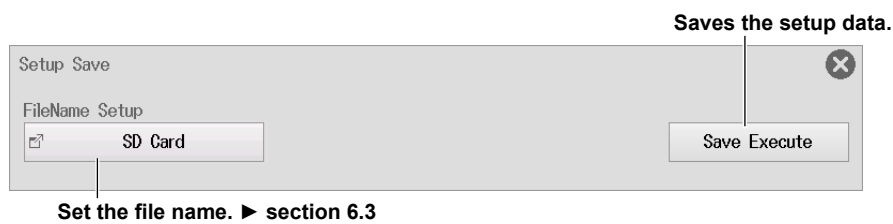

Saving Setup Data (Save Execute)

- Setup parameters are saved to a file. The extension is .SET.
- The date, time, and communication setup parameters are not saved.
- You cannot save setup data during waveform acquisition. Press START/STOP to stop the waveform acquisition.

6.5 Saving Other Types of Data

This section explains the following settings for saving the results of automated measurement of waveform parameters, snapshot waveform data, screen captures, FFT analysis results, and harmonic analysis results.

Items Common to Scope Mode and Recorder Mode

Save destination, file name, data to save, data format (screen image), color data (screen image), saving data

► [Features Guide: “Saving Other Types of Data \(Others Save\)”](#)

Save/Load Others Save Menu

1. On the waveform screen, tap **MENU > Save/Load > Others Save**. An Others Save menu appears.

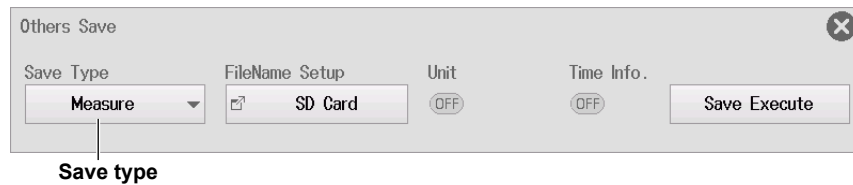

Save Type (Save Type)

Measure: You can save the results of the automated measurement of waveform parameters to a file in CSV format.

Snap: You can save the waveform data captured in a snapshot. The extension is .SNP.

Image: You can save the displayed screen image to a file in PNG, BMP, or JPEG.

FFT: You can save FFT analysis results to a file in CSV format.

Harmonic: You can save harmonic analysis results to a file in CSV format.

Automated Measurement Values of Waveform Parameters (Measure)

2. Select **Measure**.
3. Tap each item to set options and execute commands.

Proceed to step 5 on page 6-14.

The screenshot shows the 'Others Save' dialog box with the following elements and annotations:

- Save Type:** A dropdown menu set to 'Measure'. Annotation: **Set to Measure.**
- FileName Setup:** A text field containing 'SD Card'. Annotation: **Set the file name. ▶ section 6.3**
There is no comment box.
- Unit:** A radio button set to 'OFF'. Annotation: **Select whether to save the unit (ON/OFF).**
- Time Info.:** A radio button set to 'OFF'. Annotation: **Select whether to save time information (ON/OFF).**
- Save Execute:** A button to execute the save command. Annotation: **Saves automated measurement values of waveform parameters**

Snapshot (Snap)

2. Select **Snap**.
3. Tap each item to set options and execute commands.

Proceed to step 5 on page 6-14.

The screenshot shows the 'Others Save' dialog box with the following elements and annotations:

- Save Type:** A dropdown menu set to 'Snap'. Annotation: **Set to Snap.**
- FileName Setup:** A text field containing 'SD Card'. Annotation: **Set the file name. ▶ section 6.3**
There is no comment box.
- Save Execute:** A button to execute the save command. Annotation: **Saves the snapshot waveform.**

Screen Capture (Image)

2. Select **Image**.
3. Tap each item to set options and execute commands.



Save Conditions (Image Save Setup)

4. Tap **Image Save Setup**. An Image Save Setup screen appears.
 - * The specified data format and color format are displayed.

Proceed to step 5 on page 6-14.

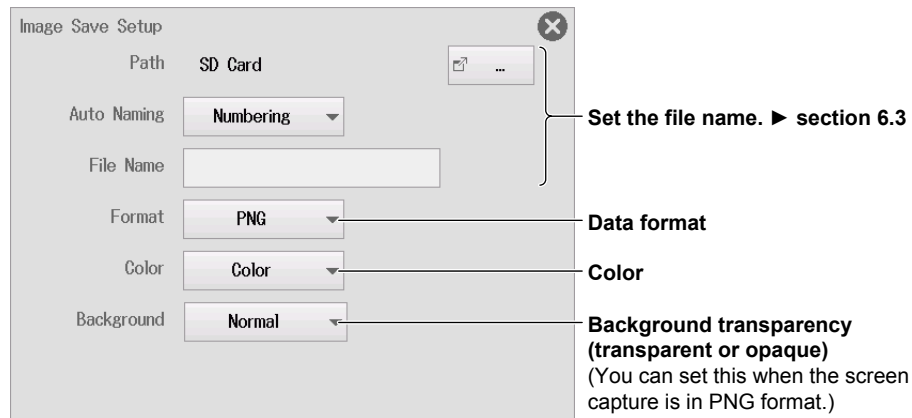

- **Data Format (Format)**

You can save the following types of files to the specified storage device. The table below shows the extensions that are automatically assigned to each format and the approximate sizes of files in each format.

Data Format	Extension	File Size ¹
PNG	*.PNG	Approx. 100 KB (approx. 50 KB) ²
JPEG	*.JPG	Approx. 250 KB
BMP	*.BMP	Approx. 1 MB (approx. 70 KB) ²

¹ When Color is set to Color, Color (Reverse), or Gray

² The file sizes in parentheses indicate the file size when Color is set to OFF.

- **Color (Color)**

OFF: A black-and-white image is produced.

Color: An image is produced with a 65536-color palette.

Color (Reverse): An image is produced with a 65536-color palette. The screen background will be white. You can select this when the color theme in environment settings is set to Black (Black).

Gray: An image is produced with a 16-color grayscale palette.

FFT Analysis Results (FFT)

2. Select **FFT**.
3. Tap each item. Use the displayed list (options) or input box to set the items.

Proceed to step 5.

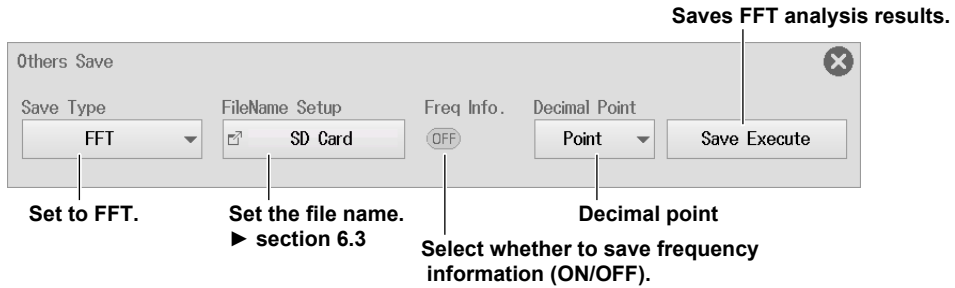

Harmonic Analysis Results (Harmonics)

2. Select **Harmonic**.
3. Tap each item to set options and execute commands.

Proceed to step 5.

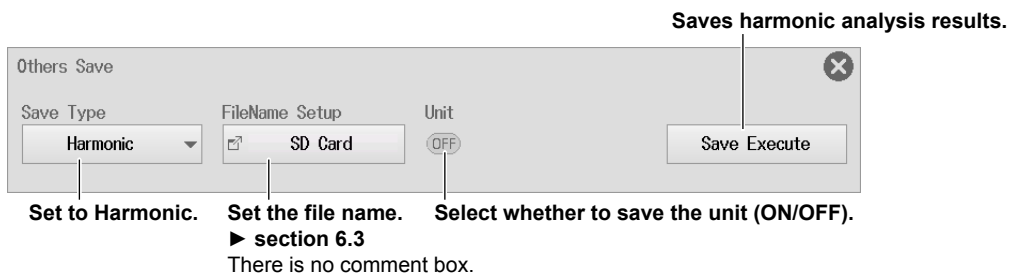

Saving (Execute Save)

5. Tap **Save Execute**. Saves the data to the specified save destination with the specified file name.

6.6 Setting the SAVE Key Function

This section explains the following settings for using the SAVE key to save waveform data and screen images and print then on a USB printer.

Items Common to Scope Mode and Recorder Mode

- Saving waveform data (save destination, file name, data format, save range, waveform to save)
- Saving a screen image (save destination, file name, data format (screen image), color data (screen image))
- Printing on a USB printer (output destination, printer type, color, comment, mode, long print (print range (output start point and output end point), print magnification)

► [Features Guide: “SAVE Key Setup \(Save Key Setup\)”](#)

Save/Load Save Key Setup Menu

1. On the waveform screen, tap **MENU > Save/Load > SAVE Key Setup**. A SAVE Key Setup menu appears.
2. Tap each item. Use the displayed list (options) or input box to set the items.

If USB printer printing is off, proceed to step 5 on page 6-18.

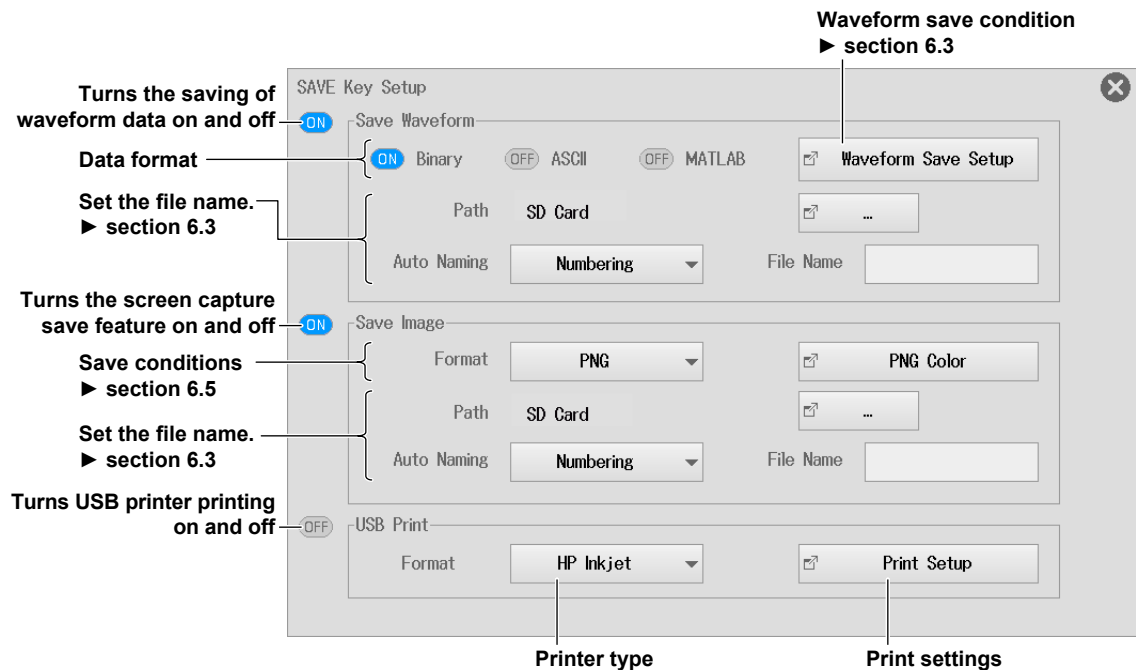

USB Printer Printing (USB Print)

3. Tap **Print Setup**. A USB Print Setup screen appears.
4. Tap each item to set options.

When the Printer Type is HP Inkjet

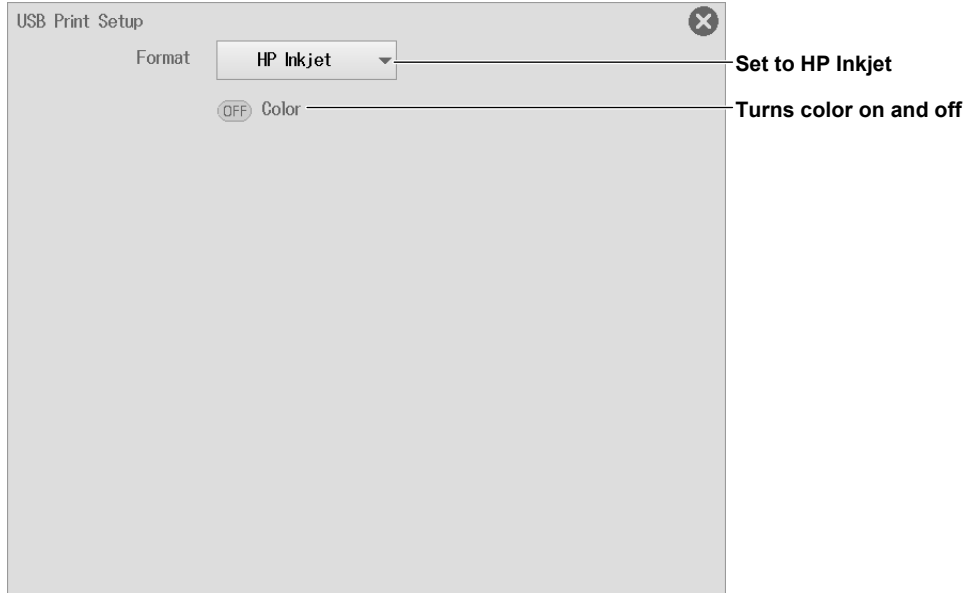

When the Printer Type is Brother

- When the mode is Hard Copy (Hard Copy)



• When the mode is Long Print (Long Print)

The screenshot shows the 'USB Print Setup' dialog box with the following settings and annotations:

- Format:** Brother (Set to Brother.)
- Mode:** Long Print (Set to Long Print.)
- Comment:** Scope mode (Comment)
- Time Range1:** -5.00div (Print range (Tap + or - to adjust.))
- Time Range2:** 5.00div (Print range (Tap + or - to adjust.))
- Print Mag:** 10ms/div (Print magnification)
- Graticle Type:** DIV (Set width of the vertical scale.)
- Display Information:** Time, Gauge, Header, Annotation (Display information)
- Annotation Type:** Trace Info (Annotation type (Appears only when the Annotation check box under Display Information is selected.))

The screenshot shows the 'Recorder mode' settings with the following annotations:

- Time Range1:** 0.00s (Print range (Tap + or - to adjust.))
- Time Range2:** 10.00s (Print range (Tap + or - to adjust.))

When Annotation Type is set to Message

The screenshot shows the 'Annotation Type' settings with the following annotations:

- Display Information:** Time, Gauge, Header, Annotation (checked)
- Annotation Type:** Message (Set the annotation type to Message.)
- Trace:** CH1 (Waveform to set)
- Message:** (Message (up to 50 characters))

6.6 Setting the SAVE Key Function

Print Magnification (Print Mag)

Set the print time magnification. Multiple pages are printed according to the print time range and print magnification.

Length of a page = 10 div (approx. 10 cm)

Note

The maximum number of pages that can be printed at once is 25. If the maximum number of print pages is exceeded, an error message will appear when printing is executed.

The method to set the magnification varies depending on whether the waveforms to be printed are sampled using the internal clock or sampled using an external clock.

- **For waveforms sampled with the internal clock**

Set using the time per division (T/div).

The selectable range varies depending on the T/div value and record length (in 1-2-5 steps).

- **For waveforms sampled with an external clock**

Set using the magnification.

Selectable range: Varies depending on the record length.

Saving

5. Press **SAVE**.

When waveform data saving and screen image saving are on, waveform data and screen image files are saved in the specified folder. When USB printer printing is on, a screen capture is output to the USB printer.

Long Print Example

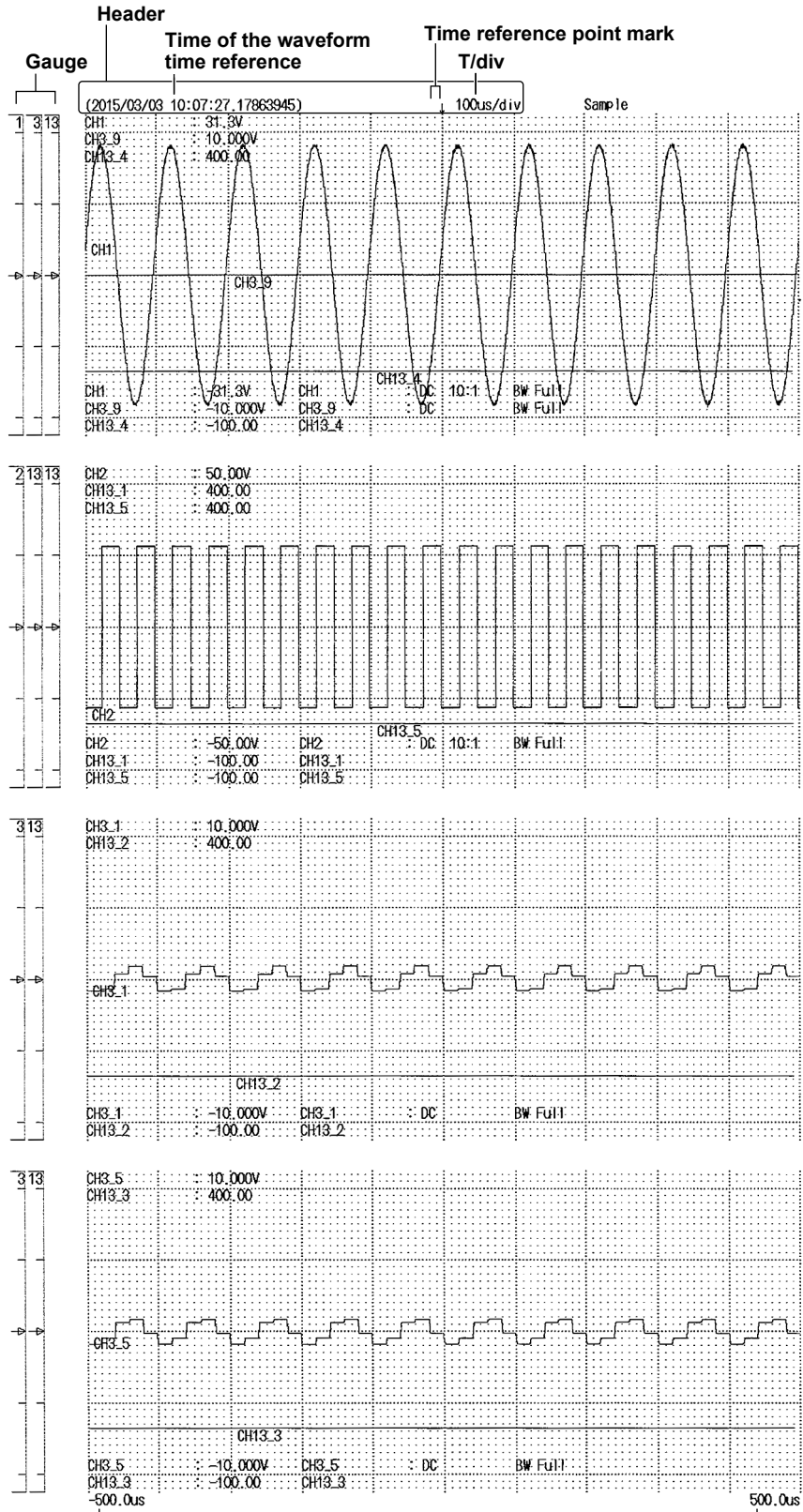

Recording start time from the time reference mark

Recording end time from the time reference mark

6.7 Loading Waveform Data

This section explains the following settings for loading waveform data):

Items Common to Scope Mode and Recorder Mode

Displaying file information, loading to channels

► [Features Guide: “Loading Waveform Data \(Waveform Load\)”](#)

Save/Load Waveform Load Menu

1. On the waveform screen, tap **MENU > Save/Load > Waveform Load**. The following screen appears.
2. Select the file to load from the file list.
3. Tap **Load**. A confirmation message appears.
4. Tap **OK** or **Cancel**.

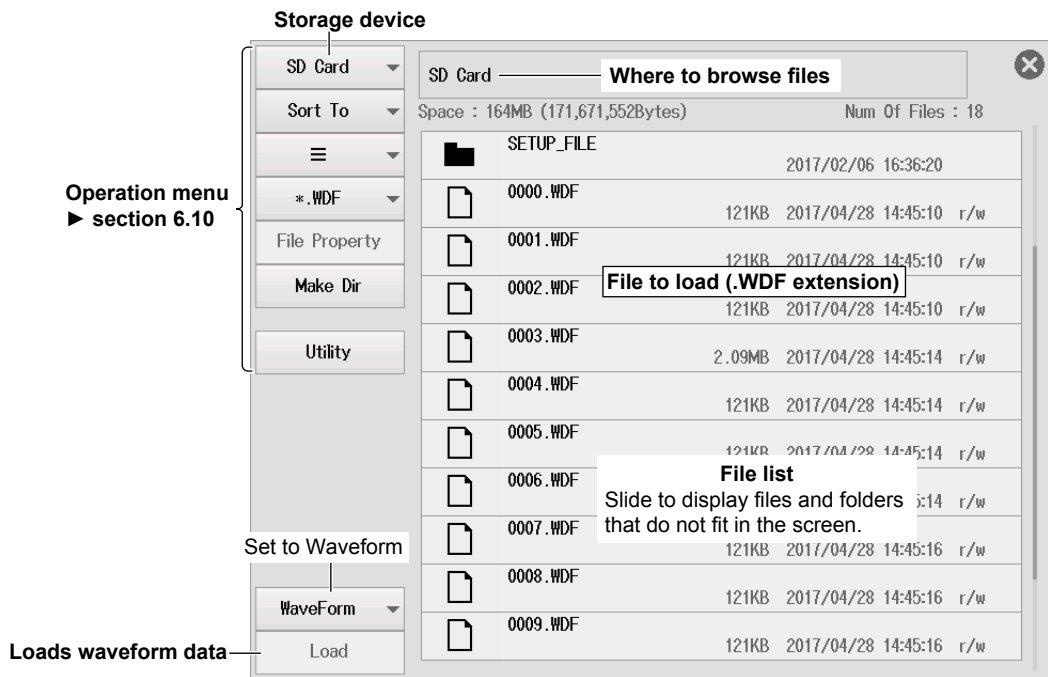

Loading Waveform Data (Load)

- The selected waveform data file is loaded together with the setup file. The extension is .WDF. Loaded data is cleared when you start measurement.
- If the module configuration when the waveform data is saved and that when the data is loaded are different, waveform data cannot be loaded.

6.8 Loading Setup Data

This section explains the following settings for loading setup data.

Items Common to Scope Mode and Recorder Mode

Displaying file information, loading setup data

► [Features Guide: “Loading Setup Data \(Setup Load\)”](#)

Save/Load Setup Load Menu

1. On the waveform screen, tap **MENU** > **Save/Load** > **Setup Load**. The following screen appears.
2. Select the file to load from the file list.
3. Tap **Load**. A confirmation message appears.
4. Tap **OK** or **Cancel**.

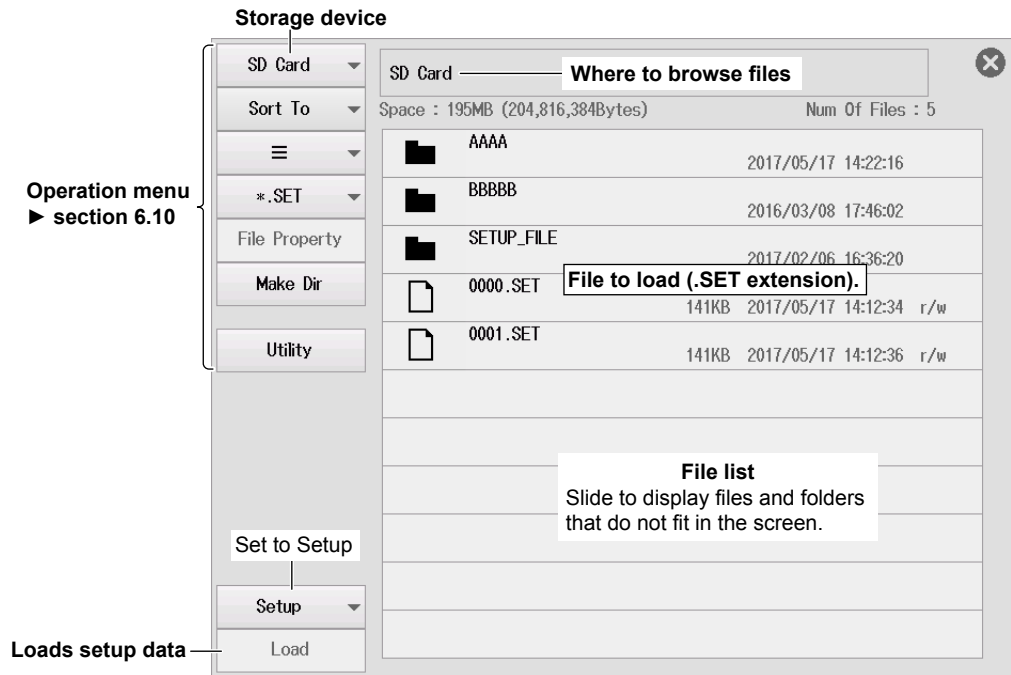

Loading Setup Data (Load)

- Select the setup data and load it. The extension is .SET.
- If the module configuration when the setup data is saved and that when the data is loaded are different, only the setup data of modules that match is loaded. When loading is complete, a message indicating the channel numbers that were not loaded is displayed.

6.9 Loading Other Types of Data

This section explains the following settings for loading snapshot waveforms or symbol definition files. Symbol definition files are displayed when a CAN bus monitor, CAN/CAN FD monitor, or CAN & LIN bus monitor module is installed.

For Scope Mode

Displaying file information, data type to load (snapshot waveform, symbol definition file), loading data

For Recorder Mode

Displaying file information, data type to load (symbol definition file), loading data

- ▶ [Features Guide: "Loading Other Types of Data \(Others Load\)"](#)
- ▶ ["Loading a CAN/CAN FD Data Definition File \(Symbol File Load\)"](#)
- ▶ ["Loading a LIN Data Definition File \(Symbol File Load\)"](#)

For Scope Mode

Save/Load Others Load Menu

1. On the waveform screen, tap **MENU > Save/Load > Others Load**.
The following screen appears.
2. To load a CAN/CAN FD or LIN data definition file (.SBL), tap , and select Symbol.
3. Select the file to load from the file list.
4. Tap **Load**. A confirmation message appears.
5. Tap **OK** or **Cancel**.

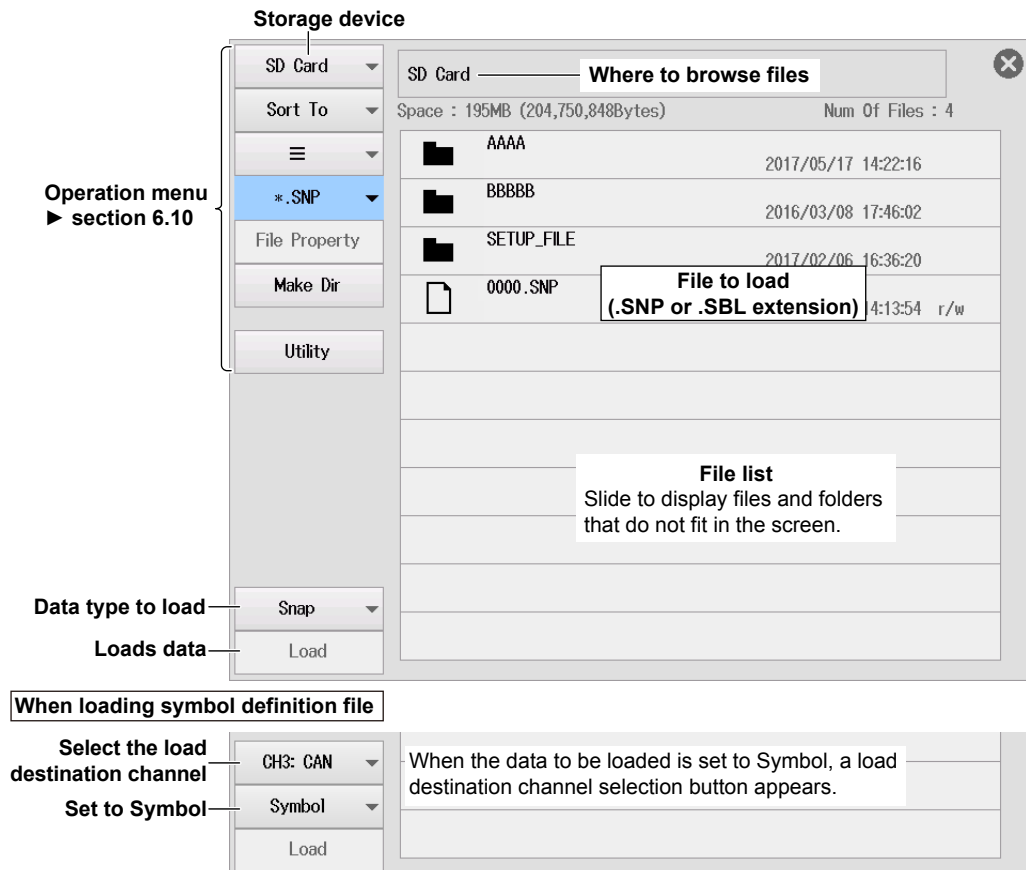

Data Type to Load

Snap: A saved snapshot waveform is loaded. The extension is .SNP.

Symbol: A CAN/CAN FD or LIN data definition file is loaded. The extension is .SBL.

Clearing the Waveform

To clear a loaded snapshot waveform, perform clear trace or initialize.

For Recorder Mode**Save/Load Symbol Load Menu**

1. On the waveform screen, tap **MENU** > **Save/Load** > **Symbol Load**.
2. Select the file to load from the file list.
 - ▶ See the figure on the previous page.
3. Select the load destination channel.
4. Tap **Load**. A confirmation message appears.
5. Tap **OK** or **Cancel**.

6.10 Performing File Operations

This section explains the following settings for performing various file operations from the file list or the file utility menu.

Items Common to Scope Mode and Recorder Mode

Changing the storage device, list sorting, display format, selecting the files to list, displaying file information, creating folders (directories), file utility (deleting files and folders, changing file and folder names, copying files and folders, moving files and folders, selecting and unselecting all)

► [Features Guide: “File Operation”](#)

Utility File Menu

1. On the waveform screen, tap **MENU > Utility > File**. The file operation screen will appear.

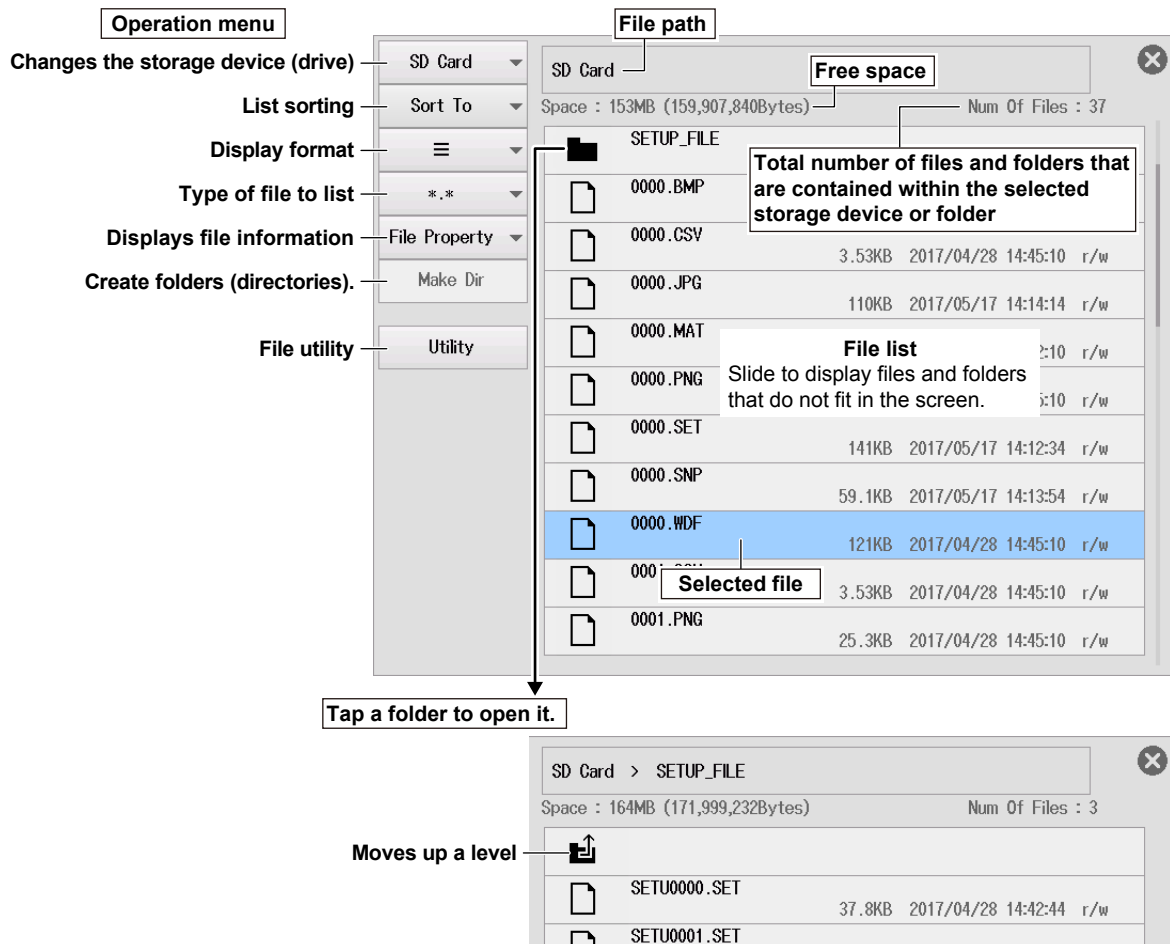

Note

The maximum number of files that can be shown in the file list is about 1000. This number varies depending on the storage device connection status and folder structure. It is possible to save files in a folder that contains more than 1000 files, but they may not appear in the file list. If this happens, delete some files or move them to another folder so that the number of files in the folder is less than about 1000 files.

Changing the Storage Device or Drive (Change Drive)

2. Tap a storage device on the menu. Use the displayed list (options) to set the storage device you want to control.

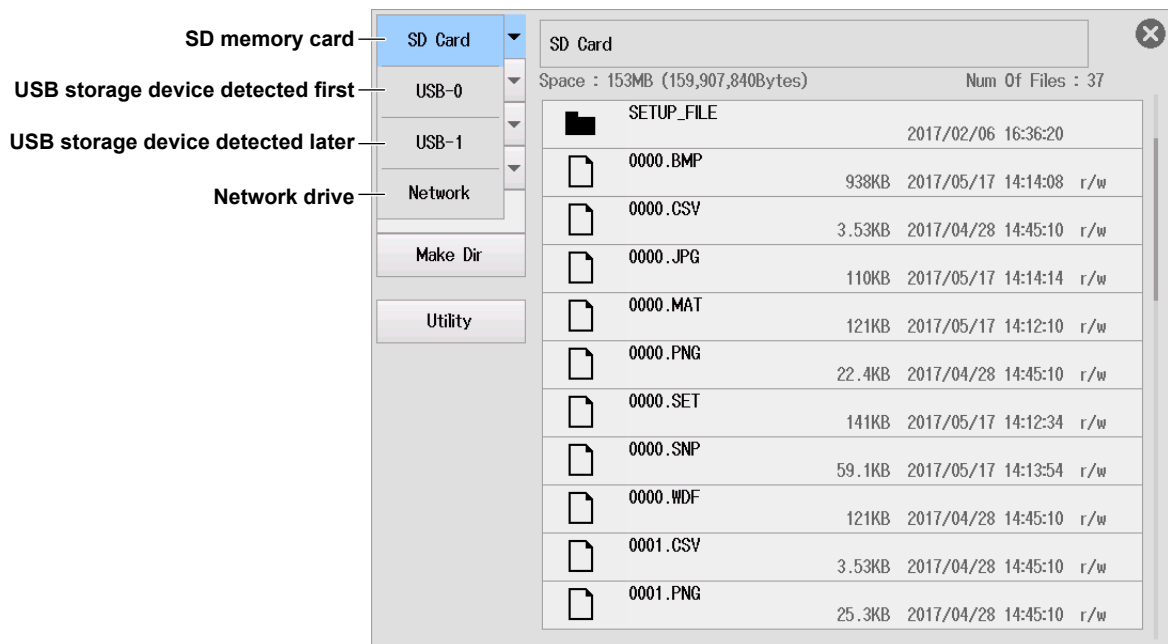

Sorting the List (Sort To)

2. On the menu, tap **Sort To**. Use the displayed list (options) to set the display order.

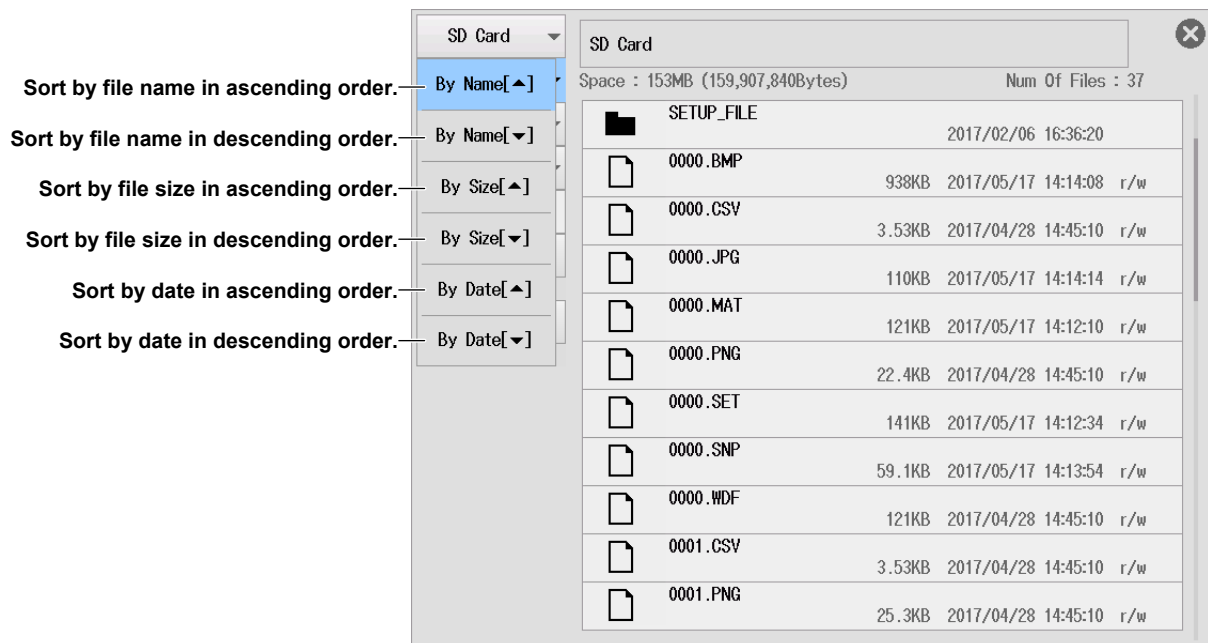

Display Format

2. Tap a display format on the menu. Use the displayed list (options) to set the display format of the file list.

List display (☰)

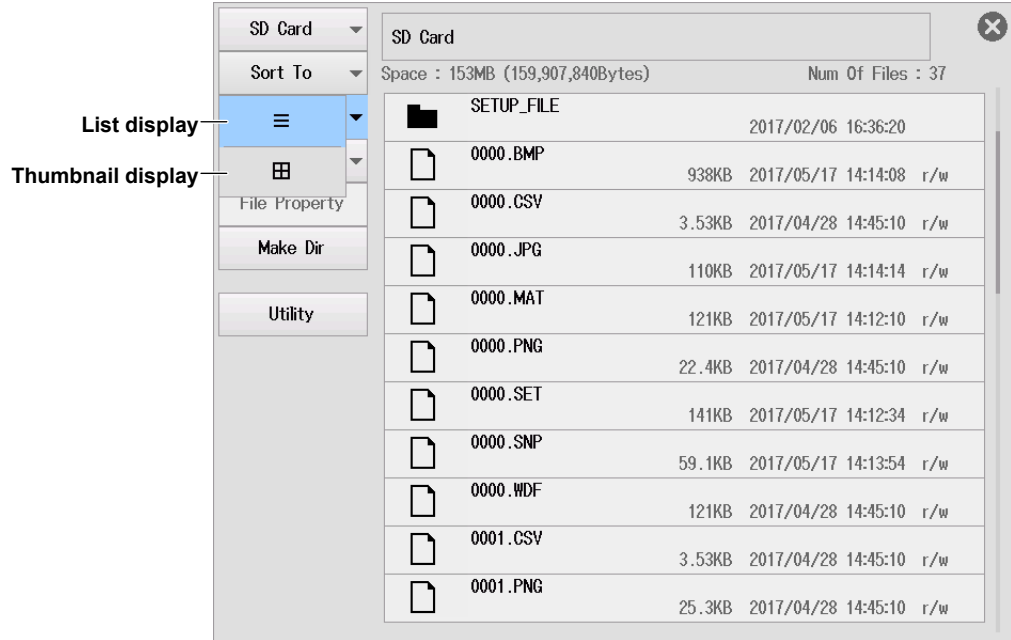

Thumbnail display (田)

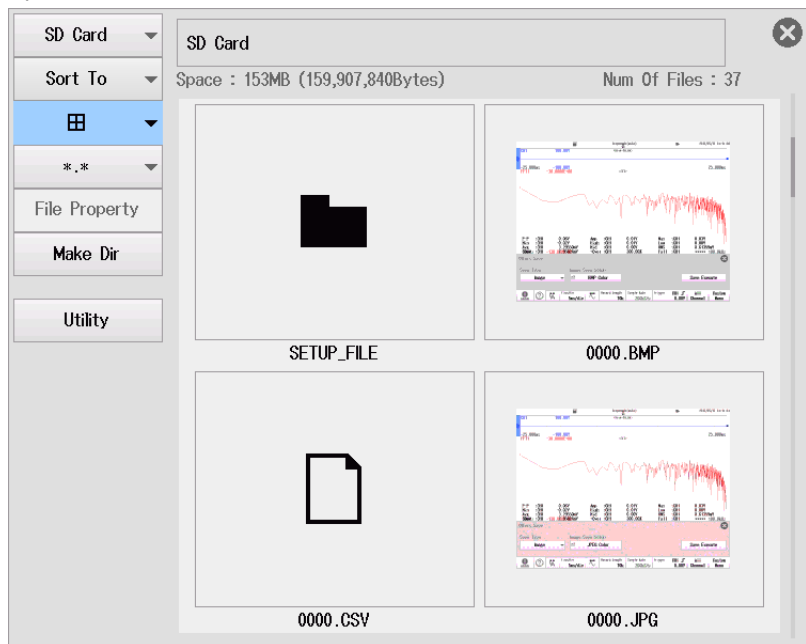

Selecting the Type of Files to List

- On the menu, tap *.* (or *.extension). Use the displayed list (options) to select the type of files to list by specifying the extension.

Select the extension of the files to list.
Slide to display extensions that do not fit in the screen.

Extension	File Type
.	All files
*.WDF	Binary waveform files
*.CSV	ASCII waveform files
*.MAT	MATLAB waveform files
*.SET	Setup files
.SET;.WDF	Setup files and binary waveform files
*.BMP	Bitmap image files
*.PNG	PNG image files
*.JPG	JPEG image files
*.SNP	Snapshot waveform files
*.SBL	SBL files (CAN/CAN FD or LIN data definition files)

Extension	File Type
.	All files
*.WDF	Binary waveform files
*.CSV	ASCII waveform files
*.MAT	MATLAB waveform files
*.SET	Setup files
.SET;.WDF	Setup files and binary waveform files
*.BMP	Bitmap image files
*.PNG	PNG image files
*.JPG	JPEG image files
*.SNP	Snapshot waveform files
*.SBL	SBL files (CAN/CAN FD or LIN data definition files)

The type of files listed is limited to the selected type.

Example When *.WDF Is Selected

Extension	File Type
.	All files
*.WDF	Binary waveform files
*.CSV	ASCII waveform files
*.MAT	MATLAB waveform files
*.SET	Setup files
.SET;.WDF	Setup files and binary waveform files
*.BMP	Bitmap image files
*.PNG	PNG image files
*.JPG	JPEG image files
*.SNP	Snapshot waveform files
*.SBL	SBL files (CAN/CAN FD or LIN data definition files)

File Properties (File Property)

- On the file list, tap the file you want to view the information of. **File Property** on the menu is enabled.
- On the menu, tap **File Property**. Information on the selected file is displayed.

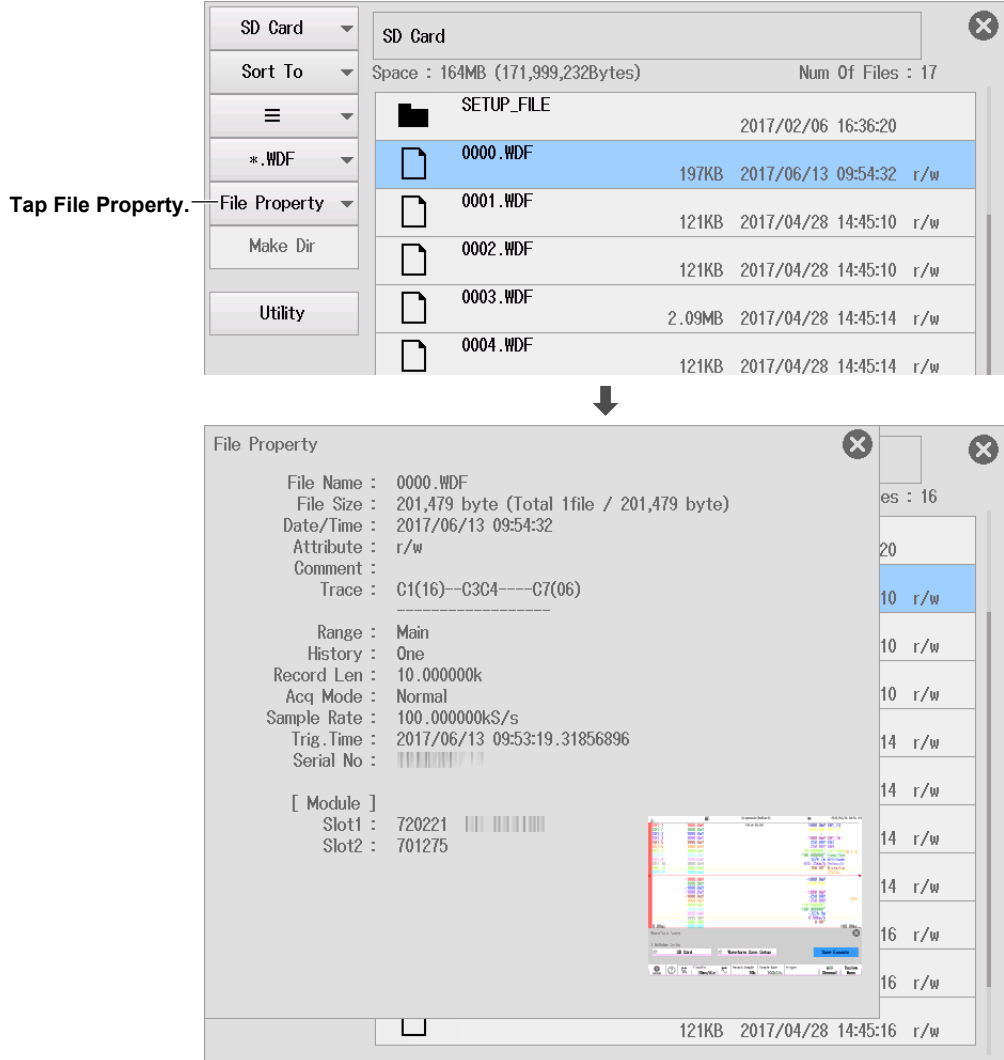

Making Folders (Make Dir)

2. Select the drive or folder in the file list that you want to make the new folder in.
3. On the menu, tap **Make Dir**. The following screen appears.

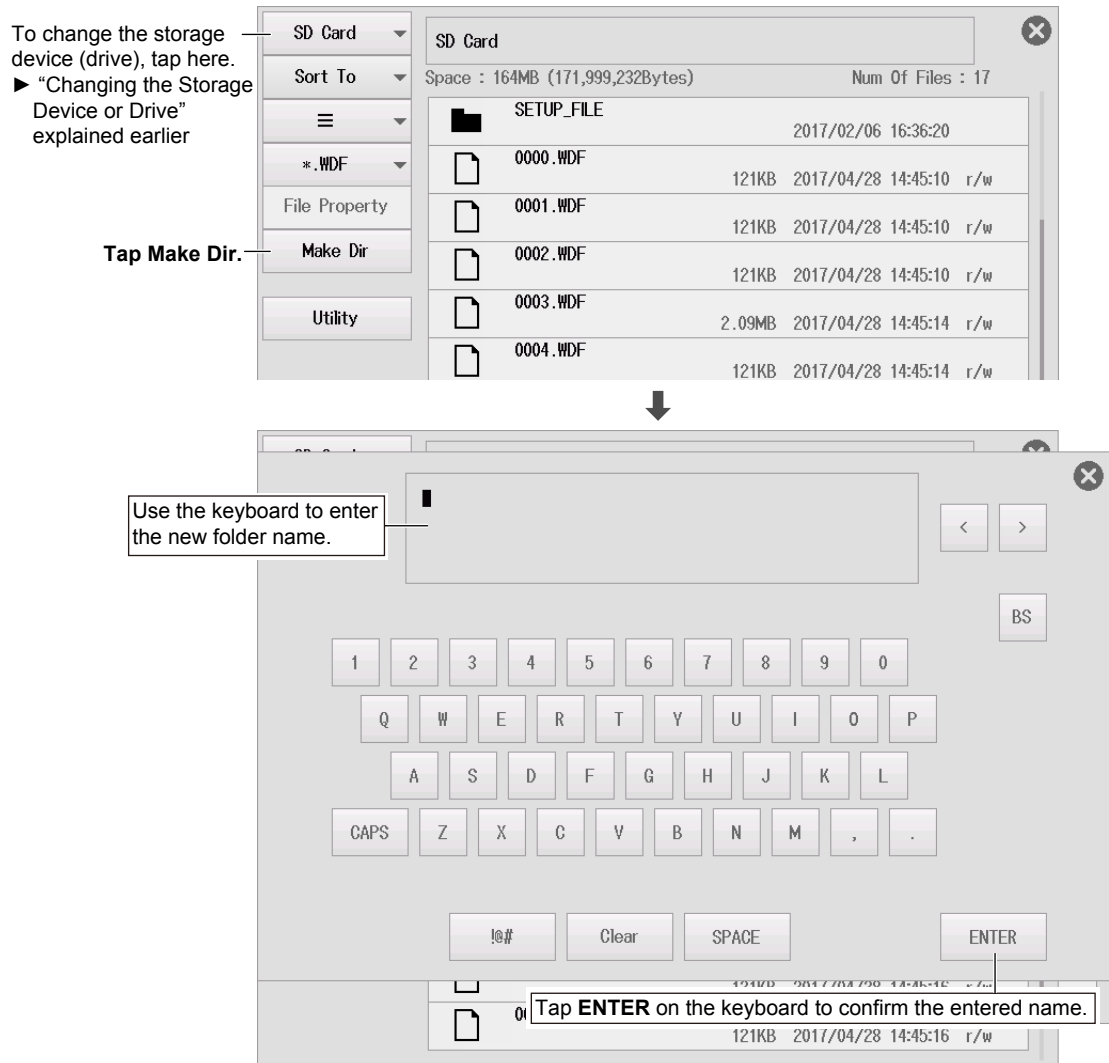

File Utility (Utility)

2. On the menu, tap **Utility**.

A utility menu opens. If the file list display format is set to list, check boxes for selecting and unselecting files and folders appear. You can select the files and folders to manipulate by tapping them on the list.

* To open a folder, close the utility menu, and tap the folder.

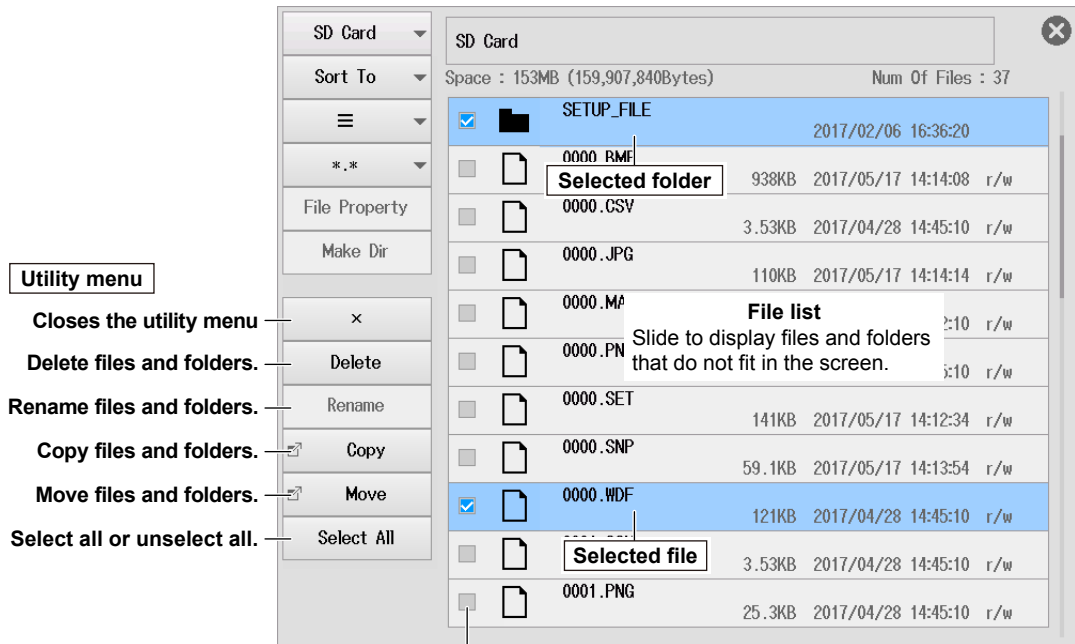

Check box
Select the check box to manipulate the corresponding item.

Deleting Files and Folders (Delete)

3. Select the file or folder that you want to delete from the file list.

4. On the utility menu, tap **Delete**. A confirmation message appears.

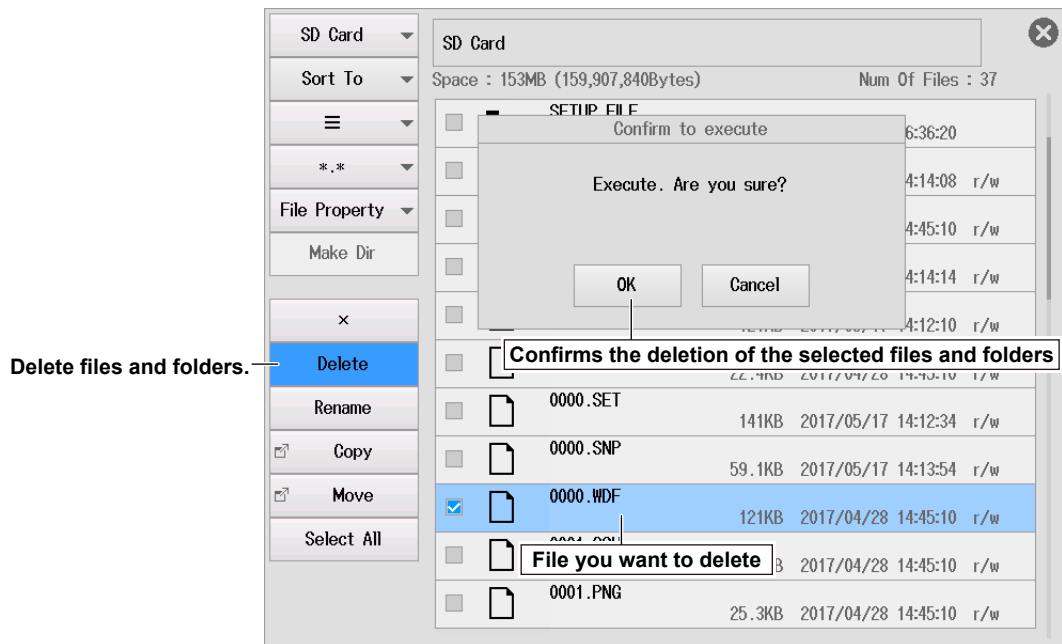

5. Tap **OK**. The progress is shown on the screen.
6. When the process is complete, tap **Close**.

Note

You can abort (Abort) file deleting. However, files that are already being processed are not applicable.

Renaming Files and Folders (Rename)

3. Select the file or folder that you want to rename from the file list.
4. On the utility menu, tap **Rename**. The following screen appears.

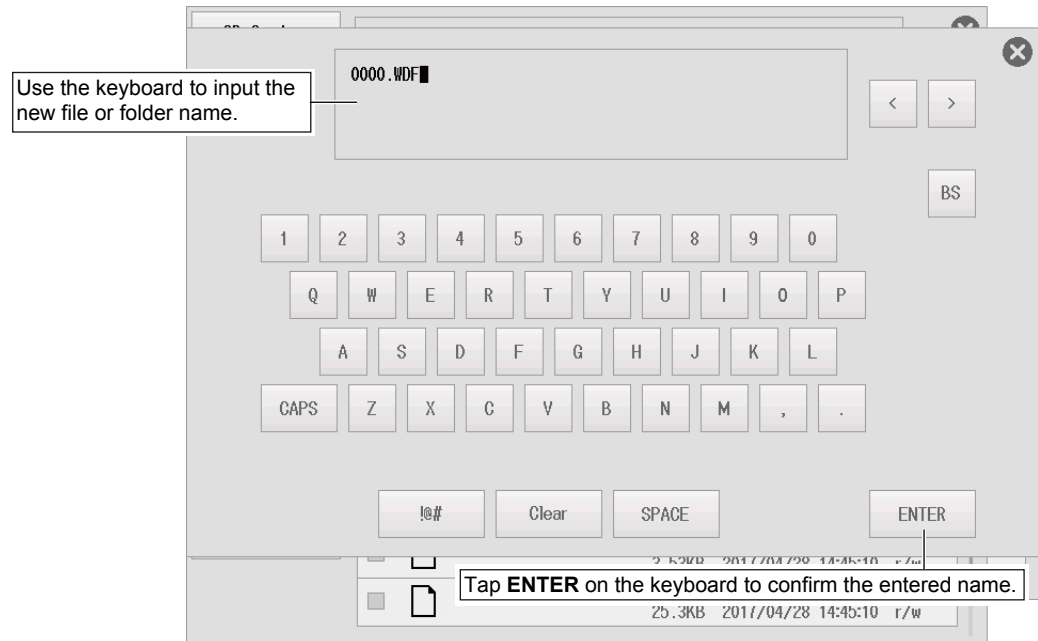

6.10 Performing File Operations

Copying Files and Folders (Copy)

3. Select the file that you want to copy from the file list.
4. On the utility menu, tap **Copy**. The following screen appears.

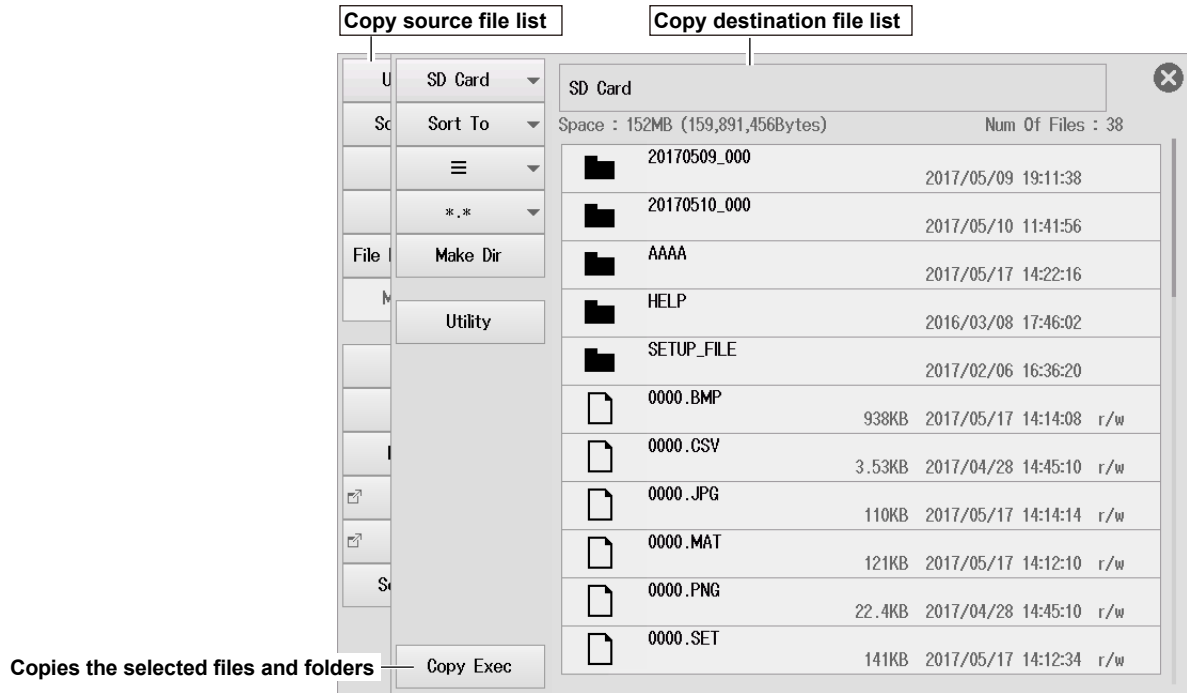

5. Select the drive or folder on the file list that you are copying to.
6. On the utility menu, tap **Copy Exec**. A confirmation message appears.

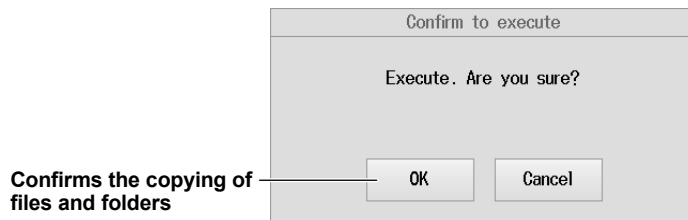

7. Tap **OK**. The progress is shown on the screen.
8. When the process is complete, tap **Close**.

Note

- You can abort (Abort) file copying.
- Changing the storage device, list sorting, display format, selecting the files to list, creating folders (directories), file utility (deleting files and folders, changing file and folder names) can also be performed on the copy destination file list.

Moving Files and Folders (Move)

3. Select the file that you want to move from the file list.
4. On the utility menu, tap **Move**. The following screen appears.

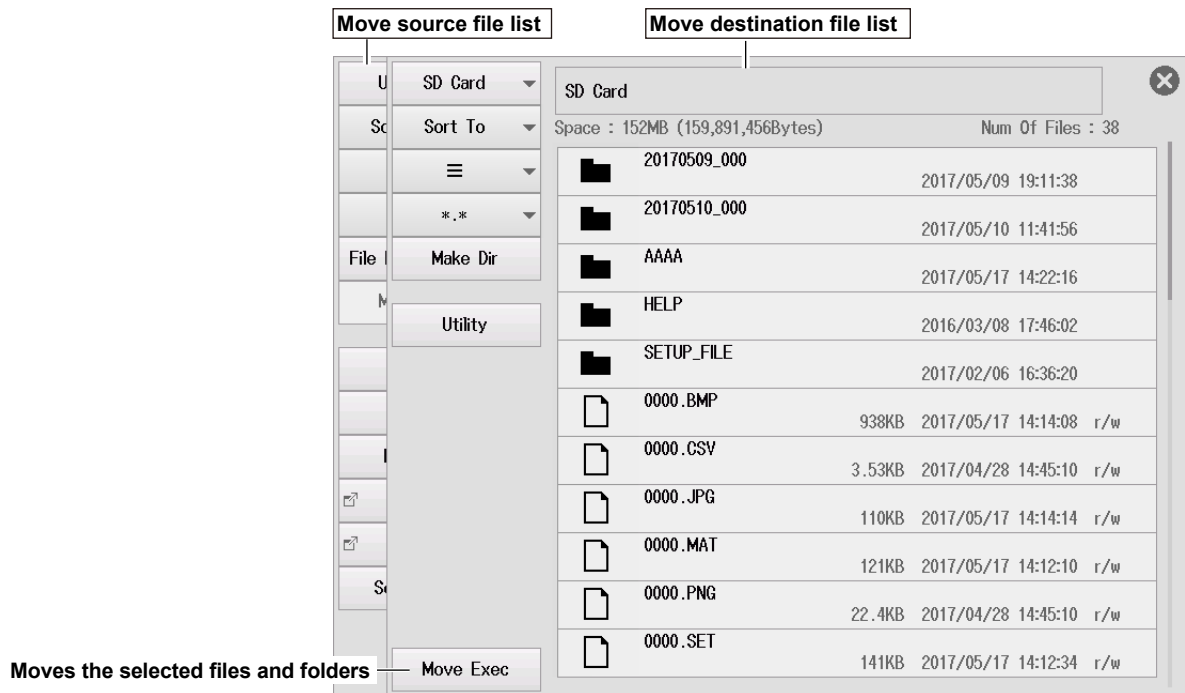

5. Select the drive or folder in the file list that you are moving to.
6. On the utility menu, tap **Move Exec**. A confirmation message appears.

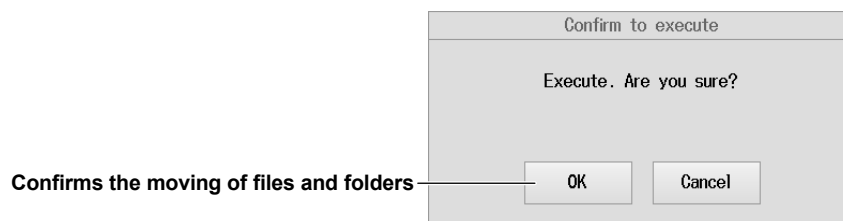

7. Tap **OK**. The progress is shown on the screen.
8. When the process is complete, tap **Close**.

Note

Changing the storage device, list sorting, display format, selecting the files to list, creating folders (directories), file utility (deleting files and folders, changing file and folder names) can also be performed on the move destination file list.

Selecting All, Unselecting All (Select All/Deselect All)

- On the utility menu, tap **Select All**. All the files and folders in the drive or folder on the file list are selected.

Select All on the utility menu changes to **Deselect All**.

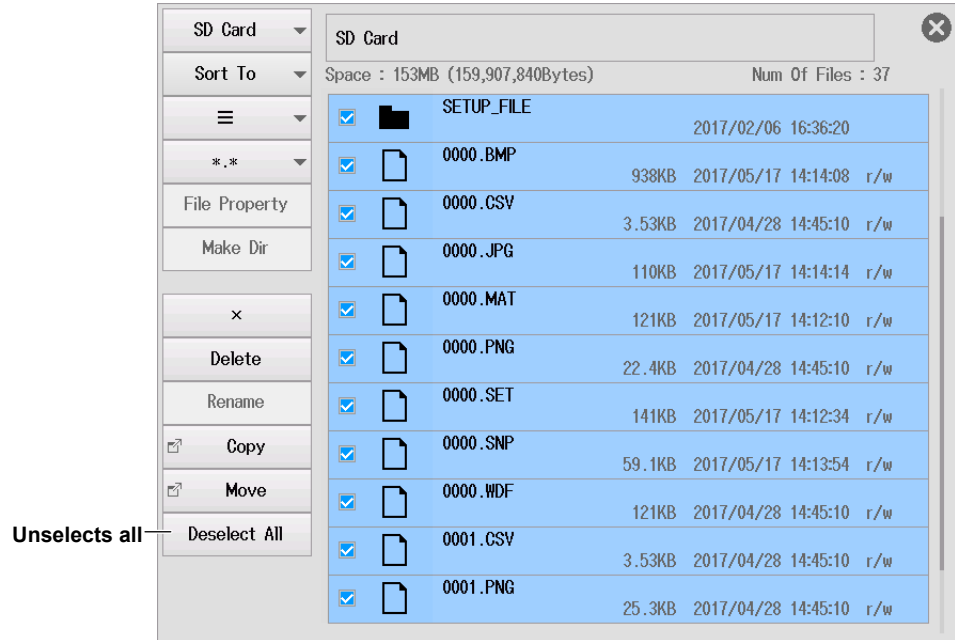

Tapping **Deselect All** unselects all the files and folders.

7.1 Measuring with Horizontal Cursors

This section explains the following settings for measuring T-Y waveforms with horizontal cursors:

Items Common to Scope Mode and Recorder Mode

Cursor measurement on/off, setting the cursor type to Horizontal, measurement source waveform, moving cursors, measurement items

For information on setting the cursor measurement items for X-Y waveforms, see chapter 11.

► [Features Guide: “Horizontal Cursors \(Horizontal\) - T-Y waveforms”](#)

Cursor Horizontal Menu

1. On the waveform screen, tap **MENU > Cursor**. The Cursor menu appears. At this point, cursor measurement is automatically turned on.
2. Tap **Type** and select Horizontal.
3. Tap each item. Use the displayed list (options) or input box to set the items.

Turns cursor measurement on or off

Source waveform
Slide to display waveforms that do not fit in the screen.

Can be set as follows within the setting range

- Retain the Cursor1 and Cursor2 interval
- Not retain the Cursor1 and Cursor2 interval

Set to Horizontal.

Move the cursors (Tap + or - to move.)
You can also tap the cursors to move them.

Measurement items

Measurement Items (Item Setup)

4. Tap **Item Setup**. The following screen appears.

Item Setup

ON Y1 ON Y2 ON ΔY — Set this to ON for items to be measured.

7.2 Measuring with Vertical Cursors

This section explains the following settings for measuring T-Y waveforms with vertical cursors:

Items Common to Scope Mode and Recorder Mode

Cursor measurement on/off, setting the cursor type to Vertical, measurement source waveform, moving cursors, measurement items

For information on setting the cursor measurement items for X-Y waveforms, see chapter 11.

► [Features Guide: “Vertical Cursors \(Vertical\) - T-Y waveforms”](#)

Cursor Vertical Menu

1. On the waveform screen, tap **MENU > Cursor**. The Cursor menu appears.
At this point, cursor measurement is automatically turned on.
2. Tap **Type** and select Vertical.
3. Tap each item. Use the displayed list (options) or input box to set the items.

Turns cursor measurement on or off

Source waveform
Slide to display waveforms that do not fit in the screen.

Can be set as follows within the setting range

- Retain the Cursor1 and Cursor2 interval
- Not retain the Cursor1 and Cursor2 interval

Set to Vertical.

Move the cursors (Tap + or - to move.)
You can also tap the cursors to move them.

Measurement items

For Scope Mode		
Cursor1	-4.000div	+
Cursor2	4.000div	+

For Recorder Mode		
-	1.000s	+
-	9.000s	+

Measurement Items (Item Setup)

4. Tap **Item Setup**. The following screen appears.

Item Setup

ON X1 ON X2 ON ΔX ON $1/\Delta X$

ON Y1 ON Y2 ON ΔY

Set this to ON for items to be measured.

7.3 Measuring with Marker Cursors

This section explains the following settings for measuring T-Y waveforms with marker cursors:

Items Common to Scope Mode and Recorder Mode

Cursor measurement on/off, setting the cursor type to Marker, marker settings (measurement source waveform, marker form, measurement items), movement target marker, marker position

For information on setting the cursor measurement items for FFT waveforms, see chapter 10.

For information on setting the cursor measurement items for X-Y waveforms, see chapter 11.

► [Features Guide: “Marker Cursors \(Marker\) - T-Y waveforms”](#)

Cursor Marker Menu

1. On the waveform screen, tap **MENU > Cursor**. The Cursor menu appears. At this point, cursor measurement is automatically turned on.
2. Tap **Type** and select Marker.
3. Tap each item. Use the displayed list (options) or input box to set the items.

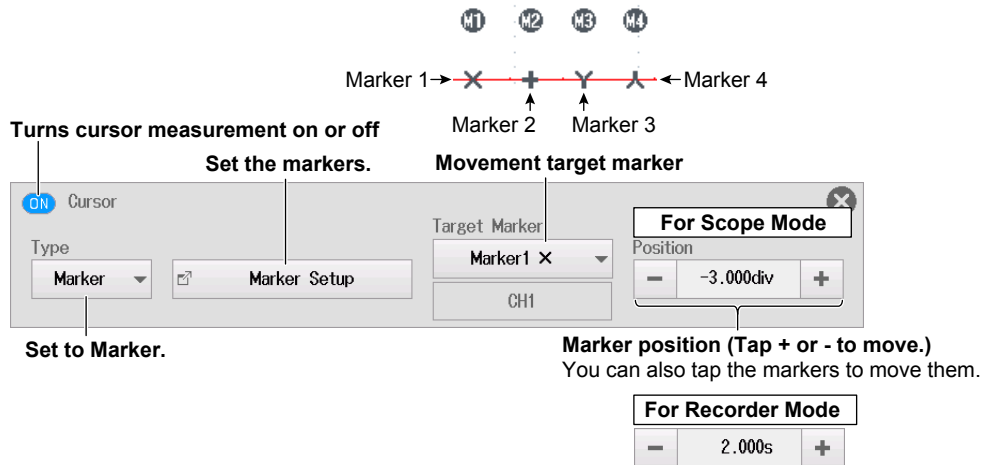

Setting the Marker (Marker Setup)

4. Tap **Marker Setup**.

Measurement Source Waveform and Marker Form (Trace)

5. Tap the **Trace** tab. The following screen appears.
6. Tap each item. Use the displayed list (options) to set the items.

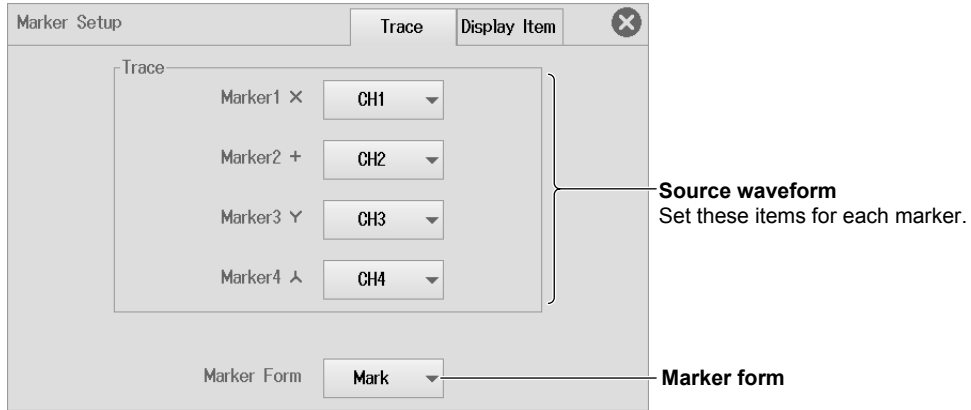

Measurement Items (Display Item)

5. Tap the **Display Item** tab. The following screen appears.



7.4 Measuring with Angle Cursors

This section explains the following settings for measuring T-Y waveforms with angle cursors:

Items Common to Scope Mode and Recorder Mode

Cursor measurement on/off, setting the cursor type to Degree, angle cursor settings (measurement source waveform, reference angle, measurement items), movement target cursor, moving cursors

► [Features Guide: “Angle Cursors \(Degree\) - T-Y waveforms”](#)

Cursor Degree Menu

1. On the waveform screen, tap **MENU > Cursor**. The Cursor menu appears. At this point, cursor measurement is automatically turned on.
2. Tap **Type** and select Degree.
3. Tap each item. Use the displayed list (options) or input box to set the items.

Can be set as follows within the setting range

- Retain the interval between cursors
- Not retain the interval between cursors

Turns cursor measurement on or off

Set the angle cursor. Movement target cursor

Set to Degree.

Move the cursors (Tap + or - to move.)*
You can also tap the cursors to move them.

For Recorder Mode

* When the movement target is Reference (reference cursor), move Ref Cursor1 and Ref Cursor2 to set the time width (time length) that corresponds to the reference angle. When the movement target is Cursor (angle cursor), move Cursor1 and Cursor2 to set the time width. The time width is converted into an angle based on the reference angle and becomes the measurement angle.

Movement target cursor	Reference	Cursor
Cursor movement Top row	Moves Ref Cursor1	Moves Cursor1
Cursor movement Bottom row	Moves Ref Cursor2	Moves Cursor2

Setting the Angle Cursor (Degree Setup)

4. Tap **Degree Setup**. The following screen appears.
5. Tap each item. Use the displayed list (options) or input box to set the items.

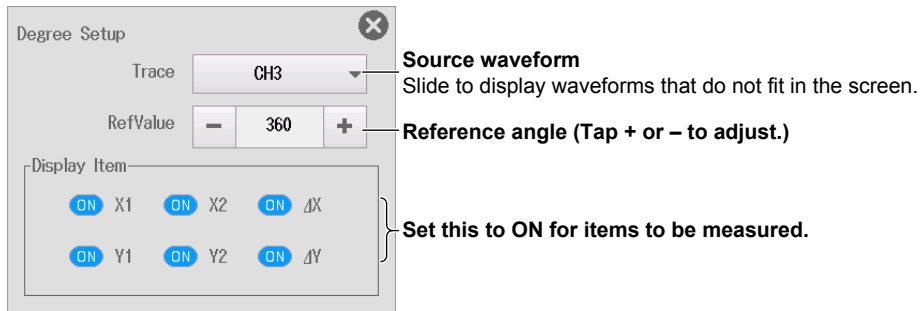

7.5 Measuring with Horizontal and Vertical Cursors

This section explains the following settings for measuring T-Y waveforms with horizontal and vertical cursors:

Items Common to Scope Mode and Recorder Mode

Cursor measurement on/off, setting the cursor type to H&V, horizontal and vertical cursor settings (measurement source waveform, measurement items), movement target cursor, moving cursors

For information on setting the cursor measurement items for X-Y waveforms, see chapter 11.

► [Features Guide: “Horizontal and Vertical Cursors \(H & V\) - T-Y waveforms”](#)

Cursor H & V Menu

1. On the waveform screen, tap **MENU > Cursor**. The Cursor menu appears. At this point, cursor measurement is automatically turned on.
2. Tap **Type** and select H & V.
3. Tap each item. Use the displayed list (options) or input box to set the items.

The screenshot shows the 'Cursor' menu with the following elements and annotations:

- Cursor**: ON (Turns cursor measurement on or off)
- Type**: H & V (Set to H & V.)
- H&V Setup**: (Set the horizontal and vertical cursors.)
- Target**: H-Cursor (Movement target cursor)
- Interval Settings**: 3.00div and 3.50div (Can be set as follows within the setting range:
 - Retain the interval between cursors
 - Not retain the interval between cursors
- Cursor Movement**: - 3.00div + and - 3.50div + (Move the cursors (Tap + or - to move.)* You can also tap the cursors to move them.)

Below the menu is a diagram showing two vertical cursors (V1, V2) and two horizontal cursors (H1, H2) on a grid. Arrows indicate the movement directions for each cursor.

In recorder mode when the movement target cursor is V-Cursor

- 1.000s +
- 9.000s +

Movement target cursor	H-Cursor	V-Cursor
Cursor movement Top row	Moves H-Cursor1	Moves V-Cursor1
Cursor movement Bottom row	Moves H-Cursor2	Moves V-Cursor2

Setting the Horizontal and Vertical Cursors (H&V Setup)

4. Tap **H&V Setup**. The following screen appears.

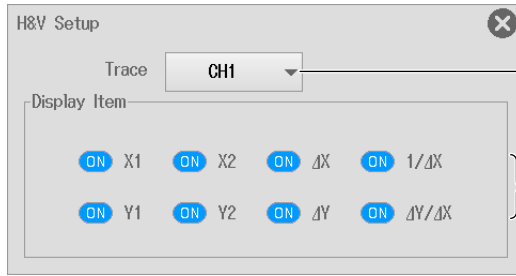

Source waveform

Slide to display waveforms that do not fit in the screen.

Set this to ON for items to be measured.

8.1 Automatically Measuring Waveform Parameters

This section explains the following settings for automatically measuring waveform parameters.

Items Common to Scope Mode and Recorder Mode

Automated measurement on/off, automated measurement parameters (measurement source waveform, measurement item, copying measurement items, delay (delay between channels)), measurement time range, 1-cycle mode on/off, high/low level setting method, time measurement reference level

► [Features Guide: “Automated Measurement of Waveform Parameters”](#)

Measure Basic Setting Menu

1. On the waveform screen, tap **MENU > Measure**. The Measure menu appears. At this point, automated measurement of waveform parameters is automatically turned on.
2. Tap the **Basic** tab.
3. Tap each item. Use the displayed list (options) or input box to set the items.

Turns automated measurement on and off

Automated measurement item

Measurement time range¹ (Tap + or – to adjust.)
You can also tap the cursors to change the measurement time range.

Turns 1-cycle mode on and off²

Can be set as follows within the setting range

- Retain the Time Range 1 and Time Range 2 interval
- Not retain the Time Range 1 and Time Range 2 interval

For Recorder Mode		
–	5.79s	+
–	7.07s	+

- 1 For SD recording waveforms, up to 100 Mpoint from the measurement start point (Time Range1) are measured.
- 2 If the space between Time Range1 and Time Range2 is less than one period, “*****” is displayed for the measured value.

Automated Measurement Items (Measure Setup)

3. Tap Measure Setup.

Source Waveform and Measurement Items

4. Tap the **Item** tab. The any of the following screens appears according to the measurement source waveform.

5. Tap each item to set options and execute commands.

- When the measurement source waveform is CH1 to CH4, 16CH VOLT, 16CH TEMP/VOLT, CAN, CAN FD, LIN, SENT, Math1 to Math2, GPS

Source waveform
Slide to display waveforms that do not fit in the screen.

Measure Setup
Item
Delay Setup
✕

Trace CH1

Peak to Peak

Amplitude

Maximum

Minimum

High

Low

Average

Middle

RMS

Std. Deviation

+Overshoot

-Overshoot

Rise

Fall

Frequency

Period

+Width

-Width

Duty

Pulse

Burst1

Burst2

Avg. Frequency

Avg. Period

Integ1TY

Integ2TY

Delay

High/Low

Measurement items
Select the check boxes for the items to be measured to turn measurement on.

All clear
All measurement items can be turned off collectively. (Clears the check boxes)

Copies to the specified channels

↓

Copy to
✕

<input type="checkbox"/> CH1	<input checked="" type="checkbox"/> CH2	<input checked="" type="checkbox"/> CH3	<input checked="" type="checkbox"/> CH4
<input checked="" type="checkbox"/> Math1	<input checked="" type="checkbox"/> Math2	-	-
-	-	-	-
-	-	-	-
-	-	-	-
-	-	-	-
-	-	-	-
-	-	-	-

Copy destination
Select the check boxes for the copy destination channels to turn copying on.

Executes the copying of the copy source settings

- When the measurement source waveform is a logic waveform

Measurement source waveform (bit)
 Slide to display waveforms (bits) that do not fit in the screen.

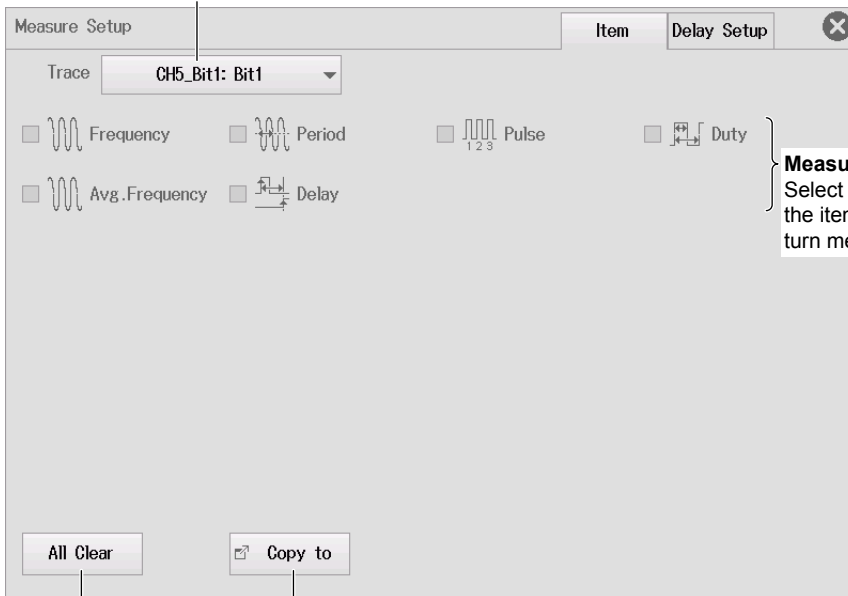

Measurement items
 Select the check boxes for the items to be measured to turn measurement on.

All clear
 All measurement items can be turned off collectively. (Clears the check boxes)

Copies to the specified channels (bits)

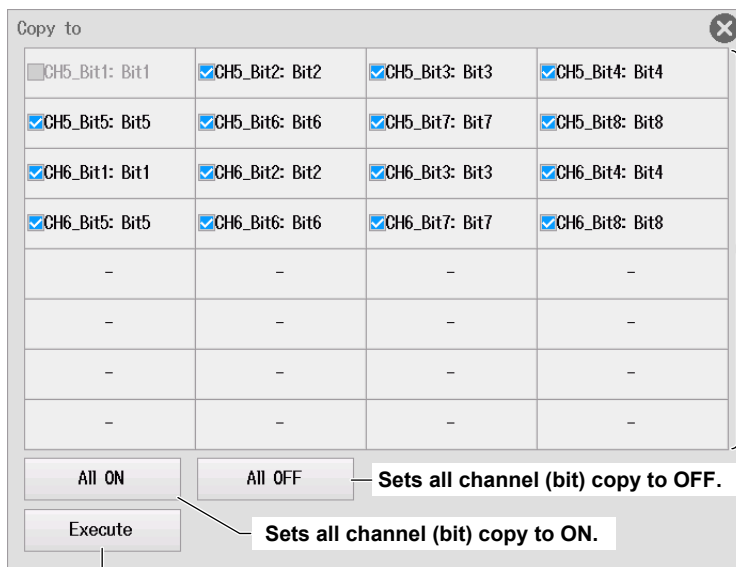

Copy destination
 Select the check boxes for the copy destination channels (bits) to turn copying on.

All ON **All OFF** **Sets all channel (bit) copy to OFF.**

Execute **Sets all channel (bit) copy to ON.**

Executes the copying of the copy source settings

8.1 Automatically Measuring Waveform Parameters

- When the measurement source waveform is an X-Y waveform

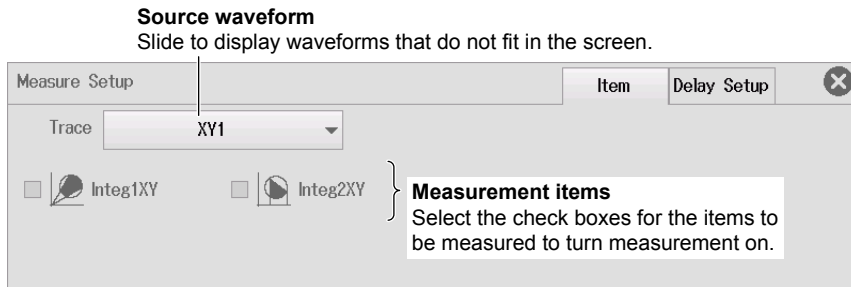

Delay (Delay between Channels)

4. Tap the **Delay Setup** tab. The following screen appears.
You cannot set the delay (delay between channels) when the measurement source waveform is an X-Y waveform.
5. Tap each item. Use the displayed list (options) or input box to set the items.

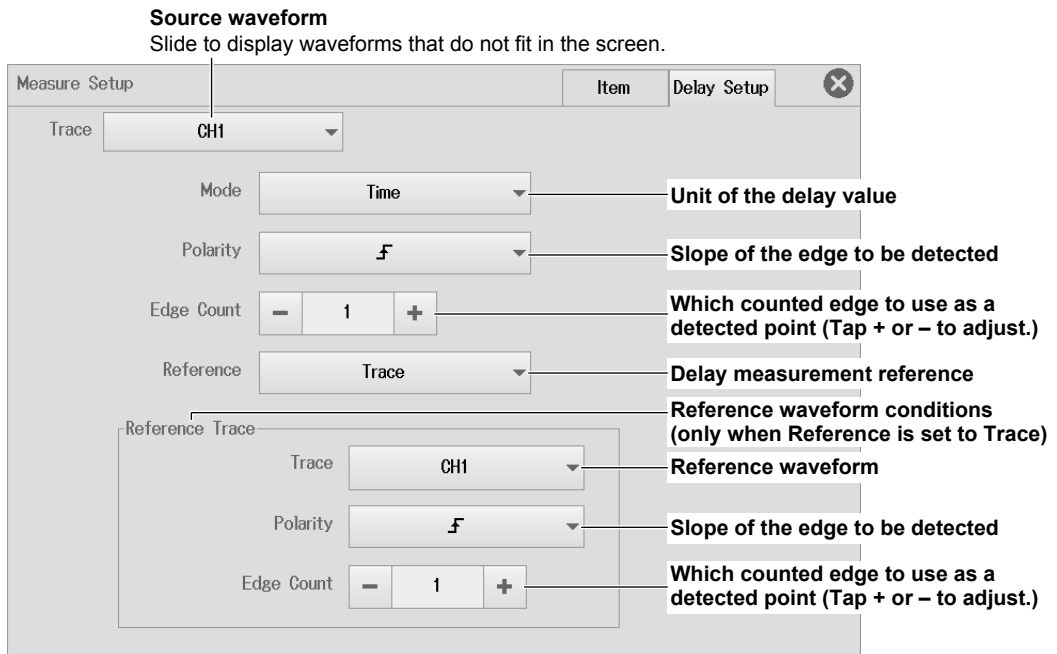

Time Measurement Reference Level (Detail)

2. Tap the **Detail** tab.
3. Tap each item. Use the displayed list (options) or input box to set the items.

Waveform to be configured

Slide to display waveforms that do not fit in the screen.
(This is synchronized to the measurement source waveform of the automated measurement item.)

- Distal - When you set the reference level unit to Unit, the Distal, Mesial, and Proximal cursors appear.
 - Mesial
 - Proximal

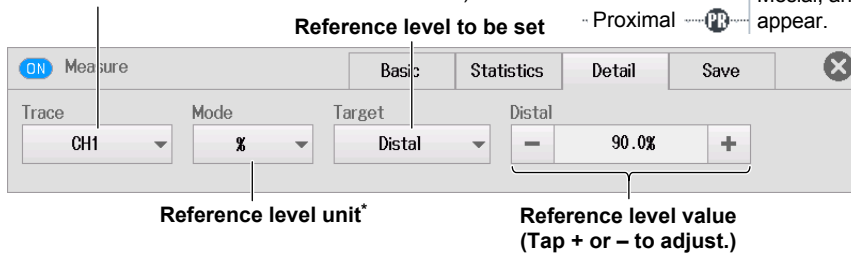

- * When the reference level unit is set to Unit
You can also tap the Distal, Mesial, and Proximal cursors to set the reference levels.

8.2 Performing Continuous Statistical Processing

This section explains the following setting for performing continuous statistical processing on the displayed waveforms:

Items Common to Scope Mode and Recorder Mode

Statistical processing on/off, setting the statistical processing type to Continuous

► [Features Guide: “Continuous Statistical Processing \(Continuous Statistics\)”](#)

Measure Statistics Menu

1. On the waveform screen, tap **MENU > Measure**. The Measure menu appears.
At this point, automated measurement of waveform parameters is automatically turned on.
2. Tap the **Statistics** tab.
3. Tap **Type** and select Continuous.

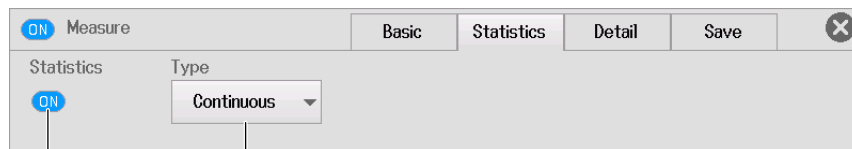

Set to Continuous.
Turns statistical processing on and off

8.3 Performing Cyclic Statistical Processing

This section explains the following settings for performing cycle statistic processing on the displayed waveforms):

Items Common to Scope Mode and Recorder Mode

Statistical processing on/off, setting the statistical processing type to Cycle, cycle trace (source waveform used to determine the cycle), displaying the results of statistical processing

► [Features Guide: “Cyclic Statistical Processing \(Cycle Statistics\)”](#)

Measure Statistics Menu

1. On the waveform screen, tap **MENU > Measure**. The Measure menu appears.
At this point, automated measurement of waveform parameters is automatically turned on.
2. Tap the **Statistics** tab.
3. Tap **Type** and select Cycle.
4. Tap each item to set options and execute commands.

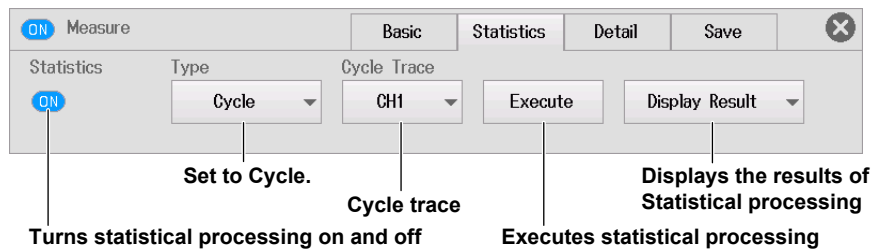

Cycle Trace (Cycle Trace)

Own

The instrument determines the cycle of each source waveform. It then automatically measures the waveform parameters and performs statistical processing for each cycle. If signals that have different periods are applied to multiple channels, the number of iterations of automated measurement and statistical processing for each signal is equal to the number of periods in the slowest signal.

CH1 to CH6, 16CH VOLT, 16CH TEMP/VOLT, CAN, CAN FD, LIN, SENT, Math1 to Math2, GPS

The instrument automatically measures the waveform parameters of all the source waveforms and performs statistical processing on the measured values for each cycle of the specified channel.

Displaying the Results of Statistical Processing

↑: Displayed next to the maximum value of each measurement item.

↓: Displayed next to the minimum value of each measurement item.

Cycle Statistics				
	+Over(CH1)	-Over(CH1)	RMS(CH2)	SDev(CH2)
8	3.10%	7.75%	1.44034V	1.44031V
9	5.97%	8.95%	1.44016V	1.44014V
10	80.00%	120.00 (↑)	1.44039V	1.44036V
11	5.79%	5.79%	1.44023V	1.44021V
12	3.10%	4.65%	1.44027V	1.44025V
13	2.17%	1.63%	1.44021V	1.44018V
14	1.38%	1.38%	1.44022V	1.44019V
15	4.46%	1.78%	1.44005V	1.44003V
16	0.45 (↓)	2.29%	1.44055 (↑)	1.44053 (↑)
17	3.33%	2.22%	1.44041V	1.44039V
18	1.48%	3.70%	1.44043V	1.44040V
19	1.47%	5.88%	1.44013V	1.44010V

Tapping the list displays the corresponding waveform.

When this scroll bar is displayed, you can scroll the display.

8.4 Performing Statistical Processing on History Waveforms

This section explains the following settings for performing statistical processing on history waveforms.

Applicable to Scope Mode

Statistical processing on/off, setting the statistical processing type to History, displaying the results of statistical processing

These settings are not available in recorder mode.

► [Features Guide: “Statistical Processing of History Waveforms \(History Statistics\)”](#)

Measure Statistics Menu

1. On the waveform screen, tap **MENU > Measure**. The Measure menu appears. At this point, automated measurement of waveform parameters is automatically turned on.
2. Tap the **Statistics** tab.
3. Tap **Type** and select History.
4. Tap each item to set options and execute commands.

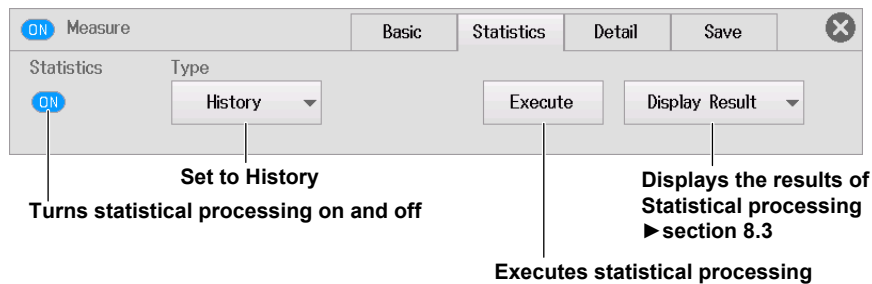

8.5 Saving Automated Measurement Values of Waveform Parameters

This section explains the following settings for saving the results of automated measurement of waveform parameters.

Items Common to Scope Mode and Recorder Mode

Saving the unit (on/off), saving time information (on/off), save destination, file name

► [Features Guide: "Saving Other Types of Data \(Others Save\)"](#)

Measure Save Menu

1. On the waveform screen, tap **MENU > Measure**. The Measure menu appears.
At this point, automated measurement of waveform parameters is automatically turned on.
2. Tap the **Save** tab.
3. Tap each item to set options and execute commands.

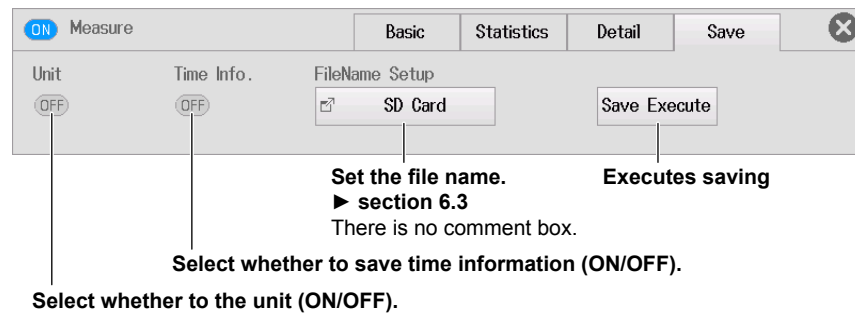

9.1 Setting Equations

This section explains the following settings for setting equations.

Items Common to Scope Mode and Recorder Mode

Target computation waveform, computation on/off, setting equations (operator, function, computation source waveform, unit, label, settings for specific operators and functions)

► [Features Guide: "Computation"](#)

Math Basic Setting Menu

1. On the waveform screen, tap **MENU > Analysis > Math**. The Math menu appears.
At this point, the computation of Math1 or Math2 is automatically turned on.
2. Tap the **Basic** tab.
3. Tap **Math1** or **Math2**, and select the target computation waveform.
4. Tap each item to set options.

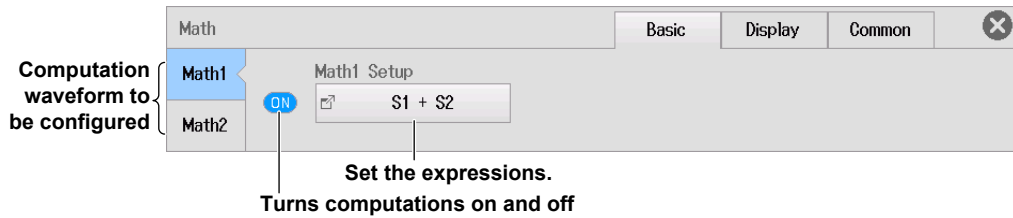

Setting the Equation (Math1 Setup, Math2 Setup)

5. Tap **Math1 Setup**. The following screen appears.
When the computation waveform is Math2, the button name changes to **Math2 Setup**.
6. Tap each item. Use the displayed list (options) or input box to set the items.

This section describes the Math1 Setup screen. Math2 Setup can be set in the same manner.

Addition, Subtraction, Multiplication, and Division

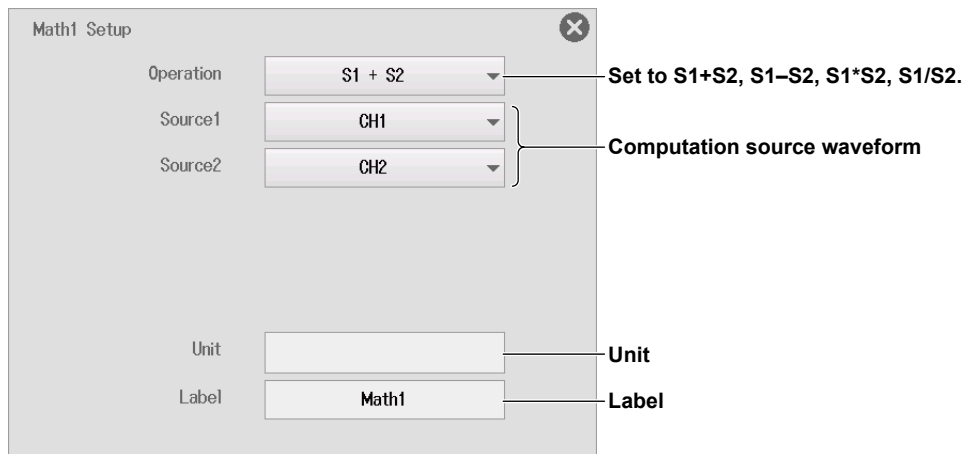

Addition, Subtraction, Multiplication, and Division with Coefficients

The screenshot shows the 'Math1 Setup' dialog box with the following fields and annotations:

- Operation:** A dropdown menu showing the formula $A(S1) + B(S2) + C$. An annotation points to it: "Set to $A(S1)+B(S2)+C$, $A(S1)-B(S2)+C$, $A(S1)*B(S2)+C$, or $A(S1)/B(S2)+C$."
- Source1:** A dropdown menu showing "CH1".
- Source2:** A dropdown menu showing "CH2".
- A:** A text input field containing "1.0000".
- B:** A text input field containing "1.0000".
- C:** A text input field containing "1.0000".
- Unit:** An empty text input field.
- Label:** A text input field containing "Math1".

Annotations on the right side of the dialog:

- A bracket groups Source1 and Source2, labeled "Computation source waveform".
- A bracket groups A, B, and C, labeled "Scaling coefficient".
- C is labeled "Offset".
- Unit is labeled "Unit".
- Label is labeled "Label".

Binary Computation

The screenshot shows the 'Math1 Setup' dialog box with the following fields and annotations:

- Operation:** A dropdown menu showing "Bin(S1)". An annotation points to it: "Set to Bin(S1)."
- Source:** A dropdown menu showing "CH1". An annotation points to it: "Computation source waveform".
- Thr. Upper:** A control with minus and plus buttons and a text input field containing "0.0V". An annotation points to it: "Upper threshold limit (Tap + or - to adjust.)"
- Thr. Lower:** A control with minus and plus buttons and a text input field containing "0.0V". An annotation points to it: "Lower threshold limit (Tap + or - to adjust.)"
- Unit:** An empty text input field.
- Label:** A text input field containing "Math1".

Annotations on the right side of the dialog:

- Unit is labeled "Unit".
- Label is labeled "Label".

Phase Shift

The screenshot shows the 'Math1 Setup' dialog box with the following fields and annotations:

- Operation:** A dropdown menu showing "Shift(S1)". An annotation points to it: "Set to Shift(S1)."
- Source:** A dropdown menu showing "CH1". An annotation points to it: "Computation source waveform".
- Shift:** A control with minus and plus buttons and a text input field containing "0.00ms". An annotation points to it: "Amount of phase shift (Tap + or - to adjust.)"
- Unit:** An empty text input field.
- Label:** A text input field containing "Math1".

Annotations on the right side of the dialog:

- Unit is labeled "Unit".
- Label is labeled "Label".

Frequency

The screenshot shows the 'Math1 Setup' dialog box with the following settings and annotations:

- Operation:** A dropdown menu set to 'FREQ(S1)'. An arrow points to it with the text 'Set to FREQ(S1)'.
- Source:** A dropdown menu set to 'CH1'. An arrow points to it with the text 'Computation source waveform'.
- Thr. Upper:** A control with a minus sign, a text field containing '0mV', and a plus sign. An arrow points to it with the text 'Upper threshold limit (Tap + or - to adjust.)'.
- Thr. Lower:** A control with a minus sign, a text field containing '0mV', and a plus sign. An arrow points to it with the text 'Lower threshold limit (Tap + or - to adjust.)'.
- Unit:** An empty text input field. An arrow points to it with the text 'Unit'.
- Label:** A text input field containing 'Math1'. An arrow points to it with the text 'Label'.

Period

The screenshot shows the 'Math1 Setup' dialog box with the following settings and annotations:

- Operation:** A dropdown menu set to 'Period(S1)'. An arrow points to it with the text 'Set to Period(S1)'.
- Source:** A dropdown menu set to 'CH1'. An arrow points to it with the text 'Computation source waveform'.
- Thr. Upper:** A control with a minus sign, a text field containing '0mV', and a plus sign. An arrow points to it with the text 'Upper threshold limit (Tap + or - to adjust.)'.
- Thr. Lower:** A control with a minus sign, a text field containing '0mV', and a plus sign. An arrow points to it with the text 'Lower threshold limit (Tap + or - to adjust.)'.
- Unit:** An empty text input field. An arrow points to it with the text 'Unit'.
- Label:** A text input field containing 'Math1'. An arrow points to it with the text 'Label'.

Moving average

The screenshot shows the 'Math1 Setup' dialog box with the following settings and annotations:

- Operation:** A dropdown menu set to 'MEAN(S1)'. An arrow points to it with the text 'Set to MEAN(S1)'.
- Source:** A dropdown menu set to 'CH1'. An arrow points to it with the text 'Computation source waveform'.
- Count:** A dropdown menu set to '10'. An arrow points to it with the text 'Average Times'.
- Unit:** An empty text input field. An arrow points to it with the text 'Unit'.
- Label:** A text input field containing 'Math1'. An arrow points to it with the text 'Label'.

Rms Value

Math1 Setup

Operation: RMS(S1) — Set to RMS(S1).

Source: CH1 — Computation source waveform

Thr. Upper: - 0mV + — Upper threshold limit (Tap + or - to adjust.)

Thr. Lower: - 0mV + — Lower threshold limit (Tap + or - to adjust.)

Unit: — Unit

Label: Math1 — Label

9.2 Setting the Display Conditions for Computed Waveforms

This section explains the following settings for displaying computed waveforms.

Items Common to Scope Mode and Recorder Mode

Vertical scale

► [Features Guide: "Computation"](#)

Math Display Setting Menu

1. On the waveform screen, tap **MENU > Analysis > Math**. The Math menu appears. At this point, the computation of Math1 or Math2 is automatically turned on.
2. Tap the **Display** tab.
3. Tap **Math1** or **Math2**, and select the target computation waveform.
4. Tap **Vert Scale**, and select Auto or Manual.
5. If you select Manual, set the upper and lower limits of the vertical scale.

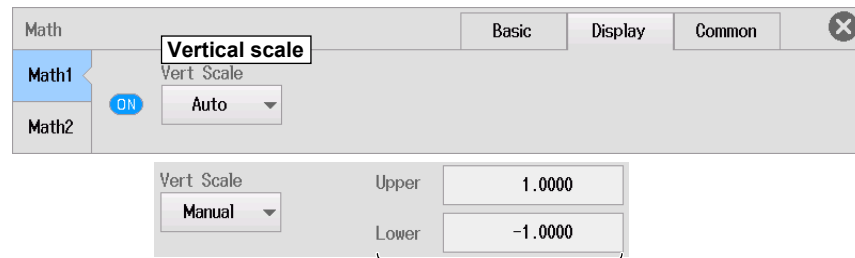

Upper and lower limits of the vertical scale

9.3 Setting the Computation Range and Averaging

This section explains the following settings for computation range and averaging.

For Scope Mode

Computation start and end points, averaging settings (including peak computation)

For Recorder Mode

Computation start and end points

► [Features Guide: “Computation”](#)

Math Common Setting Menu

1. On the waveform screen, tap **MENU > Analysis > Math**. The Math menu appears. At this point, the computation of Math1 or Math2 is automatically turned on.
2. Tap the **Common** tab.
3. Tap each item. Use the displayed list (options) or input box to set the items.

For Scope Mode

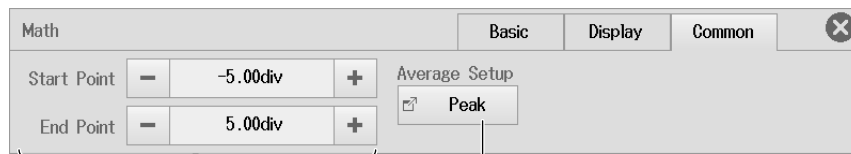

Computation start and end points
(Tap + or – to change.)

Set the average.

Configuring Averaging (Average Setup)

4. Tap **Average Setup**. The following screen appears.

- **Linear average**



Set to Linear.

Average target

Average count (acquisition count)

- Exponential average

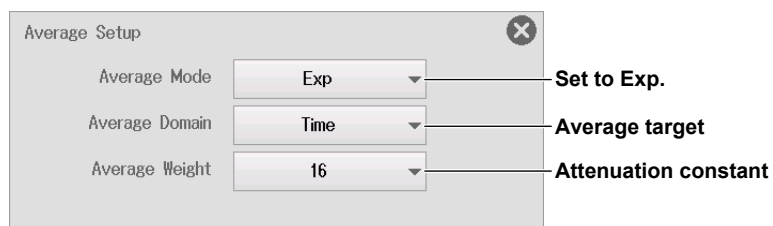

- Cycle average

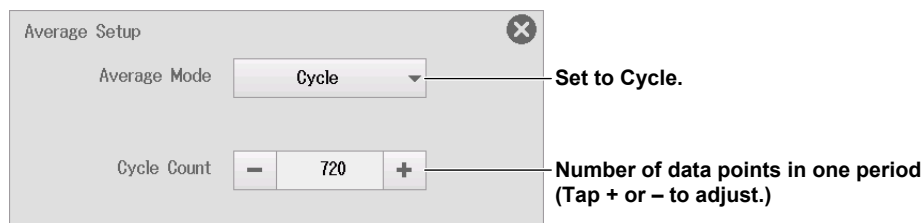

- Peak computation

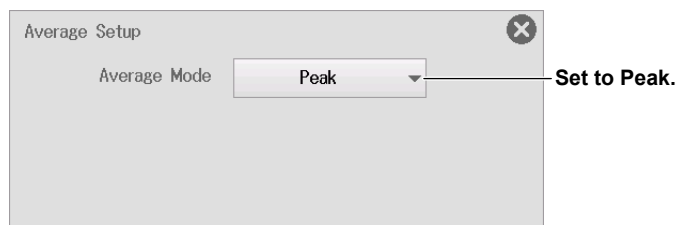

For Recorder Mode

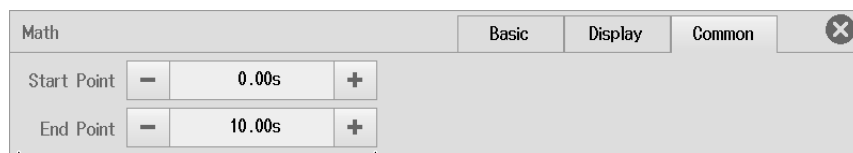

Computation start and end points
(Tap + or - to change.)

10.1 Setting Conversion Equations

This section explains the following settings for the conversion equation of FFT analysis.

Items Common to Scope Mode and Recorder Mode

Target FFT waveform, FFT analysis on/off, FFT settings (spectrum type, analysis source waveform, unit)

► [Features Guide: "FFT"](#)

FFT Basic Setting Menu

1. On the waveform screen, tap **MENU > Analysis > FFT**. The FFT menu appears.
At this point, the FFT analysis of FFT1 or FFT2 is automatically turned on.
2. Tap the **Basic** tab.
3. Tap **FFT1** or **FFT2**, and select the target FFT waveform.
4. Tap each item to set options.

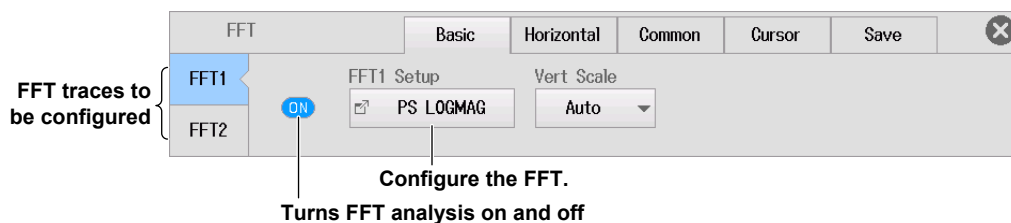

Setting the FFT (FFT1 Setup, FFT2 Setup)

5. Tap **FFT1 Setup**. The following screen appears.
When the computation waveform is FFT2, the button name changes to **FFT2 Setup**.
6. Tap each item. Use the displayed list (options) or input box to set the items.

This section describes the FFT1 Setup screen. FFT2 Setup can be set in the same manner.

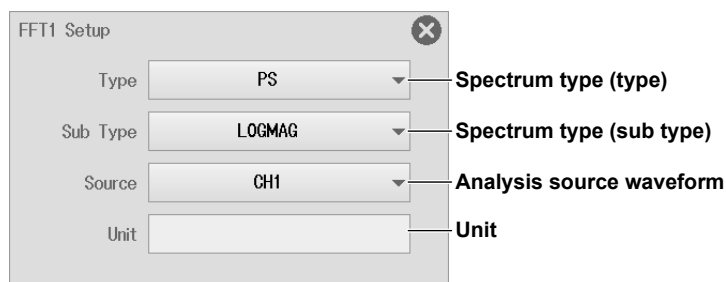

10.2 Setting the Vertical Axis of the FFT

This section explains the following settings for the vertical axis of the FFT.

Items Common to Scope Mode and Recorder Mode

Vertical scale

► [Features Guide: “FFT”](#)

FFT Basic Setting Menu

1. On the waveform screen, tap **MENU > Analysis > FFT**. The FFT menu appears.
At this point, the FFT analysis of FFT1 or FFT2 is automatically turned on.
2. Tap the **Basic** tab.
3. Tap **FFT1** or **FFT2**, and select the target FFT waveform.
4. Tap **Vert Scale**, and select Auto or Manual.
5. If you select Manual, set the center point and sensitivity of the vertical axis.

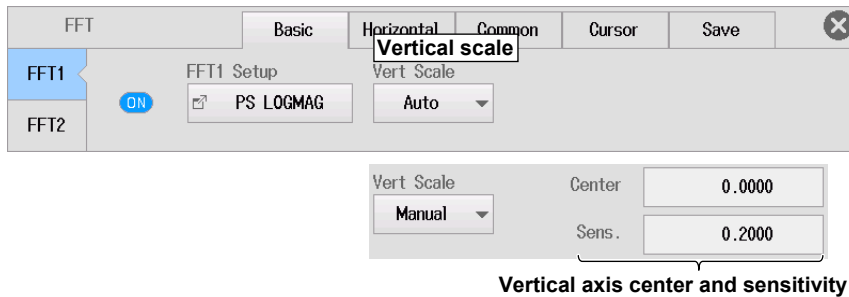

10.3 Setting the Horizontal Axis of the FFT

This section explains the following settings for the horizontal axis of the FFT.

Items Common to Scope Mode and Recorder Mode

Horizontal scale display method, Horizontal scale unit, horizontal range

► [Features Guide: "FFT"](#)

FFT Horizontal Menu

1. On the waveform screen, tap **MENU > Analysis > FFT**. The FFT menu appears. At this point, the FFT analysis of FFT1 or FFT2 is automatically turned on.
2. Tap the **Horizontal** tab.
3. Tap **FFT1** or **FFT2**, and select the target FFT waveform.
4. Tap each item. Use the displayed list (options) or input box to set the items.

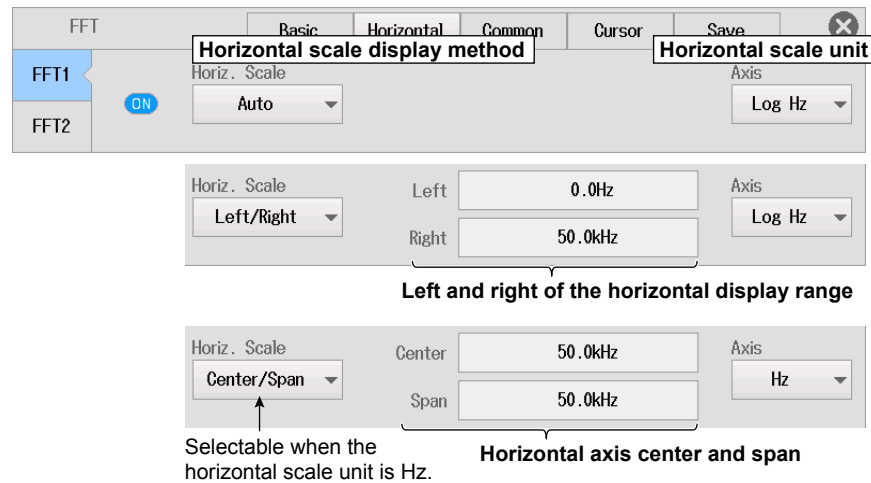

10.4 Setting the Analysis Start Point, Number of FFT Points, Window Function, and Averaging

This section explains the following settings for performing FFT analysis.

For Scope Mode

Analysis start point, detail settings (number of FFT points, window function, averaging settings (including peak computation))

For Recorder Mode

Analysis start point, detail settings (number of FFT points, window function)

► [Features Guide: “FFT”](#)

FFT Common Setting Menu

1. On the waveform screen, tap **MENU > Analysis > FFT**. The FFT menu appears. At this point, the FFT analysis of FFT1 or FFT2 is automatically turned on.
2. Tap the **Common** tab.
3. Tap each item. Use the displayed list (options) or input box to set the items.

For Scope Mode

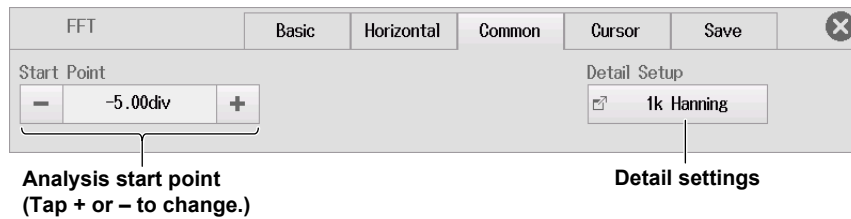

Detail Settings (Detail Setup)

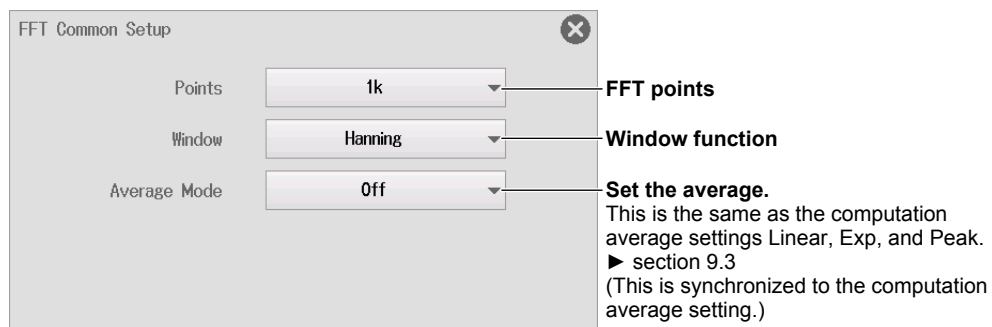

For Recorder Mode

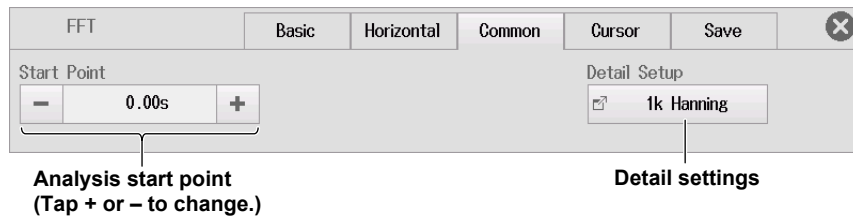

Detail Settings (Detail Setup)

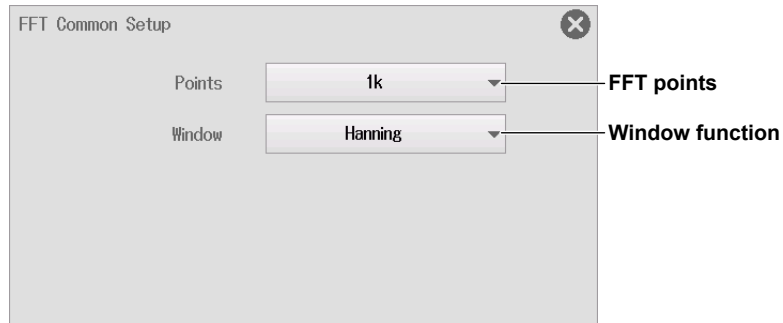

10.5 Measuring FFT Waveforms with Cursors

This section explains the following settings for measuring FFT waveforms with cursors for each cursor type:

Items Common to Scope Mode and Recorder Mode

Cursor measurement on/off, cursor type, measurement source waveform, moving cursors, measurement items, marker settings, marker position, peak detection range

► [Features Guide: "Cursor Measurement on FFT Waveforms"](#)

FFT Cursor Menu

1. On the waveform screen, tap **MENU > Analysis > FFT**. The FFT menu appears.
At this point, the FFT analysis of FFT1 or FFT2 is automatically turned on.
2. Tap the **Cursor** tab.

Measuring FFT Waveforms with Marker Cursors (Marker)

3. Tap **Type** and select Marker.
4. Tap each item. Use the displayed list (options) or input box to set the items.

Turns cursor measurement on or off

Set the markers.

Movement target marker

Cursor ON

Type Marker

Marker Setup

Marker No. Marker1

Position -4.64div

Marker position (Tap + or - to move.)
You can also tap the markers to move them.

Setting the Marker (Marker Setup)

5. Tap **Marker Setup**.

- **Measurement Source Waveform and Marker Form (Trace)**

6. Tap the **Trace** tab. The following screen appears.

7. Tap each item. Use the displayed list (options) to set the items.

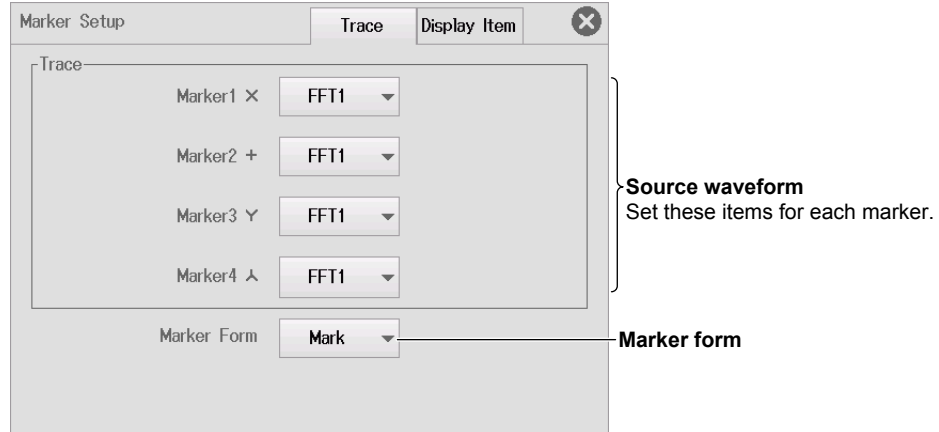

- **Measurement Items (Display Item)**

6. Tap the **Display Item** tab. The following screen appears.

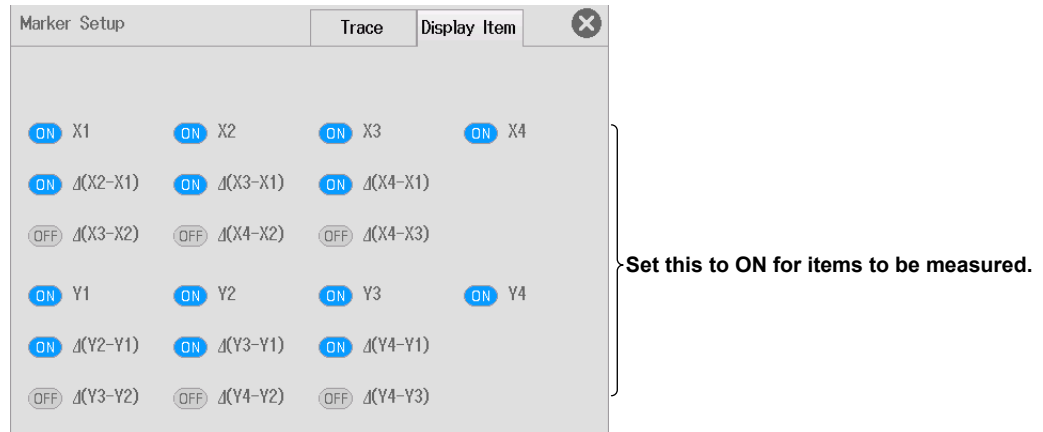

Measuring FFT Waveforms with Peak Cursors (Peak)

3. Tap **Type** and select Peak.
4. Tap each item. Use the displayed list (options) or input box to set the items.

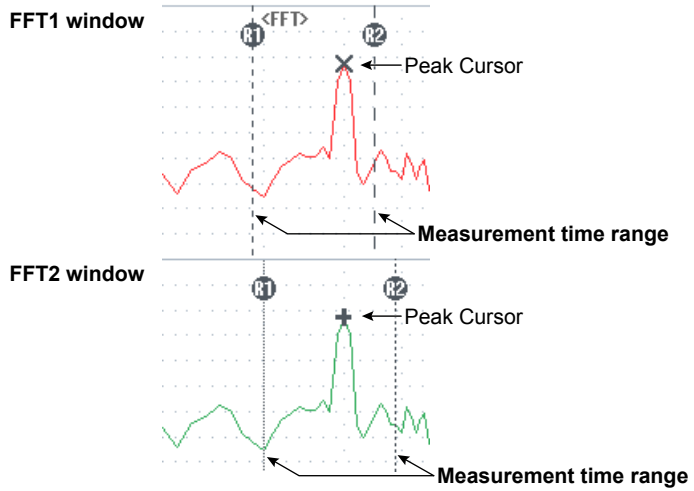

Turns cursor measurement on or off

Measurement items		Measurement source FFT window	
Cursor	Type	Range	Cursor
<input checked="" type="checkbox"/>	Peak	FFT1	Save
	Peak Setup	Range 1	-4.62div
		Range 2	-4.30div

Set to Peak.

Measurement time range (Tap + or - to change.)
 You can also tap the range cursors (R1, R2) to change the range.

Measurement Items (Peak Setup)

5. Tap **Peak Setup**. The following screen appears.

Peak Setup	
<input checked="" type="checkbox"/> F1	<input checked="" type="checkbox"/> F2
<input checked="" type="checkbox"/> Y1	<input checked="" type="checkbox"/> Y2

Set this to ON for items to be measured.

10.6 Saving the Results of FFT Analysis

This section explains the following settings for saving the results of FFT analysis.

Items Common to Scope Mode and Recorder Mode

Saving frequency information (on/off), decimal point, save destination, file name

► [Features Guide: "Saving Other Types of Data \(Others Save\)"](#)

FFT Save Menu

1. On the waveform screen, tap **MENU > Analysis > FFT**. The FFT menu appears.
At this point, the FFT analysis of FFT1 or FFT2 is automatically turned on.
2. Tap the **Save** tab.
3. Tap each item to set options and execute commands.

Select whether to save frequency information (ON/OFF).

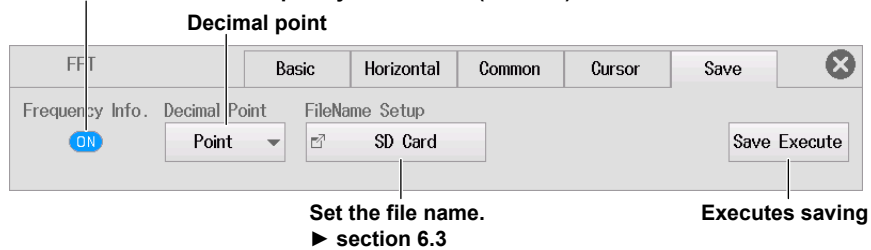

11.1 Setting the X-Y Waveform Trace

This section explains the following settings for displaying X-Y waveforms.

Items Common to Scope Mode and Recorder Mode

X-Y waveform display on/off, source waveform (X-axis, Y-axis), start point and end point of display range

► [Features Guide: “X-Y Waveforms”](#)

X-Y Basic Setting Menu

1. On the waveform screen, tap **MENU** > **Analysis** > **X-Y**. An X-Y window and X-Y menu appear.
2. Tap the **Basic** tab.
3. Tap each item. Use the displayed list (options) or input box to set the items.

Turns the X-Y window display on and off

Can be set as follows within the setting range

- Retain the start-point and end-point interval
- Not retain the start-point and end-point interval

Turn the X-Y waveform on and off and set the source waveforms.

Start and end points of display range (Tap + or - to adjust.)

For Recorder Mode

-	0.00s	+
-	10.00s	+

Turning the X-Y Waveform Display On and Off and Setting the Source Waveforms (XY Trace Setup)

4. Tap **XY Trace Setup**. The following screen appears.

XY Trace Setup

	Display	X Trace	Y Trace
XY1	ON	CH1	CH2
XY2	OFF	CH1	CH2

X-axis source waveforms

Y-axis source waveforms

Set the X-Y waveform items you want to display to ON.

11.2 Setting the Display Conditions for X-Y Waveforms

This section explains the following settings for the display conditions of X-Y waveforms.

Items Common to Scope Mode and Recorder Mode

Interpolation method, number of points to use to display waveforms, display ratio of main window, window layout, pen marker on/off, clearing waveforms at acquisition start on/off

► [Features Guide: “X-Y Waveforms”](#)

X-Y Display Setting Menu

1. On the waveform screen, tap **MENU** > **Analysis** > **X-Y**. An X-Y window and X-Y menu appear.
2. Tap the **Display** tab.
3. Tap each item. Use the displayed list (options) or input box to set the items.

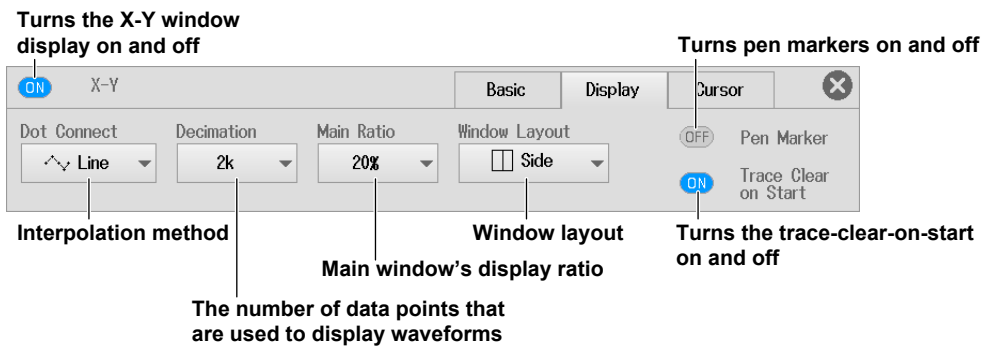

11.3 Measuring X-Y Waveforms with Cursors

This section explains the following settings for measuring X-Y waveforms with cursors for each cursor type:

Items Common to Scope Mode and Recorder Mode

Cursor measurement on/off, cursor type, measurement source waveform, moving cursors, measurement items, marker settings, marker position

► [Features Guide: "Cursor Measurement on X-Y Waveforms"](#)

X-Y Cursor Menu

1. On the waveform screen, tap **MENU** > **Analysis** > **X-Y**. An X-Y window and X-Y menu appear.
2. Tap the **Cursor** tab.

Measuring with X-Y Waveforms with Horizontal Cursors

3. Tap **Type** and select Horizontal.
4. Tap each item. Use the displayed list (options) or input box to set the items.

The screenshot shows the X-Y Cursor menu with the following annotations:

- Turns the X-Y window display on and off:** Points to the **X-Y** toggle switch.
- Turns cursor measurement on or off:** Points to the **Cursor** toggle switch.
- Set to Horizontal:** Points to the **Type** dropdown menu.
- Source waveform:** Points to the **Trace** dropdown menu.
- Move the cursors (Tap + or - to move.):** Points to the **Cursor1** and **Cursor2** value fields.
- Measurement items:** Points to the **Item Setup** button.
- Can be set as follows within the setting range:** Points to the **Cursor** sub-menu, which contains:
 - Retain the Cursor1 and Cursor2 interval
 - Not retain the Cursor1 and Cursor2 interval

Measurement Items (Item Setup)

5. Tap **Item Setup**. The following screen appears.

The **Item Setup** screen shows three toggle switches for measurement items:

- Y1:** ON
- Y2:** ON
- ΔY :** ON

— Set this to ON for items to be measured.

Measuring X-Y Waveforms with Vertical Cursors

3. Tap **Type** and select Vertical.
4. Tap each item. Use the displayed list (options) or input box to set the items.

Turns the X-Y window display on and off

Source waveform

Can be set as follows within the setting range

- Retain the Cursor1 and Cursor2 interval
- Not retain the Cursor1 and Cursor2 interval

Turns cursor measurement on or off

Set to Vertical.

Move the cursors (Tap + or - to move.)
You can also tap the cursors to move them.

Measurement items

Measurement Items (Item Setup)

5. Tap **Item Setup**. The following screen appears.

Item Setup

X1 X2 ΔX — Set this to ON for items to be measured.

Measuring X-Y Waveforms with Marker Cursors (Marker)

3. Tap **Type** and select Marker.
4. Tap each item. Use the displayed list (options) or input box to set the items.

Turns the X-Y window display on and off

Set to Marker.

Turns cursor measurement on or off

Set the markers.

Movement target marker

Marker position* (Tap + or - to move.)
You can also tap the markers to move them.

* You can move the marker positions also by moving the X1, X2, X3, and X4 cursors displayed in the T-Y waveform area. X1, X2, X3, and X4 cursors correspond to Marker 1, Marker 2, Marker 3, and Marker 4, respectively.

Setting Markers (Marker Setup)

5. Tap **Marker Setup**.
- **Measurement Source Waveform and Marker Form (Trace)**
6. Tap the **Trace** tab. The following screen appears.

Source waveform
Set these items for each marker.

Marker form

• Measurement Items (Display Item)

7. Tap the **Display Item** tab. The following screen appears.

Set this to ON for items to be measured.

Measuring X-Y Waveforms with Horizontal and Vertical Cursors (H & V)

3. Tap **Type** and select H & V.
4. Tap each item. Use the displayed list (options) or input box to set the items.

Turns the X-Y window display on and off

Set the horizontal and vertical cursors.

Can be set as follows within the setting range

- Retain the interval between cursors
- Not retain the interval between cursors

Movement target cursor

Turns cursor measurement on or off

Set to H & V.

Move the cursors (Tap + or - to move.) You can also tap the cursors to move them.

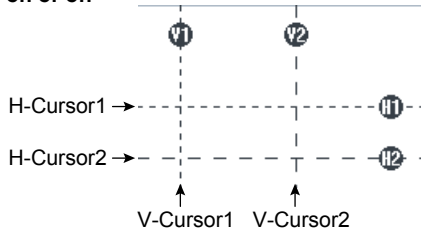

Movement target cursor	H-Cursor	V-Cursor
Cursor movement Top row	Moves H-Cursor1	Moves V-Cursor1
Cursor movement Bottom row	Moves H-Cursor2	Moves V-Cursor2

Setting Horizontal and Vertical Cursors (H&V Setup)

5. Tap **H&V Setup**. The following screen appears.

Source waveform

Set this to ON for items to be measured.

12.1 Setting the Harmonic Analysis Conditions

This section explains the following settings for harmonic analysis conditions.

Items Common to Scope Mode and Recorder Mode

Harmonic analysis display on/off, fundamental frequency, start point, harmonic analysis on voltage and current, harmonic analysis on active power

► Features Guide: “Harmonic Analysis”

Harmonic Analysis Basic Setting Menu

1. On the waveform screen, tap **MENU > Analysis > Harmonic**. The Harmonic menu appears. At this point, harmonic analysis is automatically turned on.
2. Tap the **Basic** tab.
3. Tap each item. Use the displayed list (options) or input box to set the items.

Turns harmonic analysis result display on and off

Fundamental frequency

Start point (Tap + or - to adjust.)

Set the harmonic analysis on voltage and current.

Set the harmonic analysis on active power.

For Recorder Mode

Setting the Harmonic Analysis on Voltage and Current (Line RMS Setup)

4. Tap **Line RMS Setup**. The following screen appears.

Item	Mode	Source	Hysteresis
LineRMS1	ON	CH1	#
LineRMS2	OFF	CH1	#
LineRMS3	OFF	CH1	#
LineRMS4	OFF	CH1	#
LineRMS5	OFF	CH1	#
LineRMS6	OFF	CH1	#
LineRMS7	OFF	CH1	#
LineRMS8	OFF	CH1	#

Set the analysis mode for items you want to analyze to ON.

Computation source waveform

Hysteresis

Setting the Harmonic Analysis on Active Power (Power Setup)

4. Tap **Power Setup**. The following screen appears.

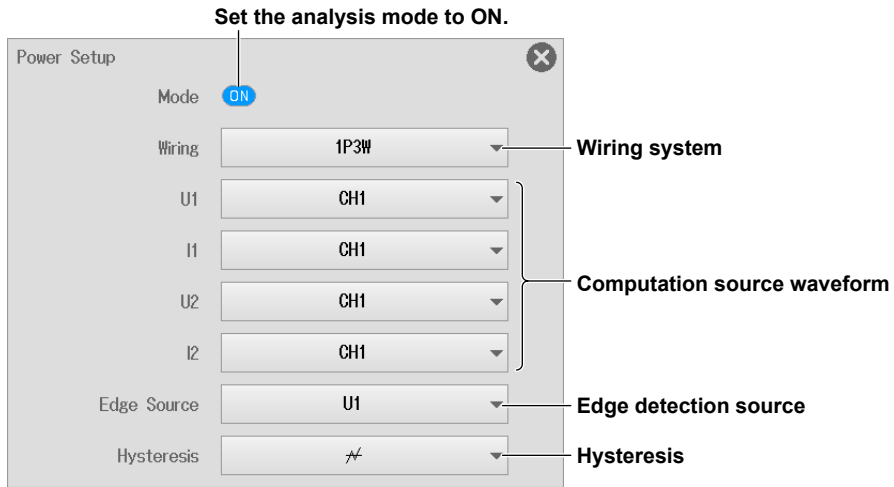

12.2 Setting the Harmonic Analysis Display Conditions

This section explains the following settings for harmonic analysis display conditions.

Items Common to Scope Mode and Recorder Mode

Display mode, displayed items, displayed order, phase scale, vertical scale

► [Features Guide: "Display \(Display\)"](#)

Harmonic Analysis Display Setting Menu

1. On the waveform screen, tap **MENU > Analysis > Harmonic**. The Harmonic menu appears. At this point, harmonic analysis is automatically turned on.
2. Tap the **Display** tab.
3. Tap **Mode** and select the display mode.
4. Tap each item. Use the displayed list (options) or input box to set the items.

Turns harmonic analysis result display on and off

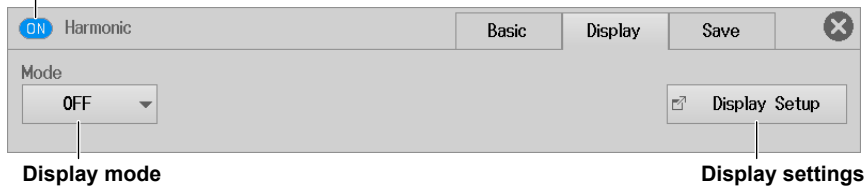

When the display mode is Bar



When the display mode is List

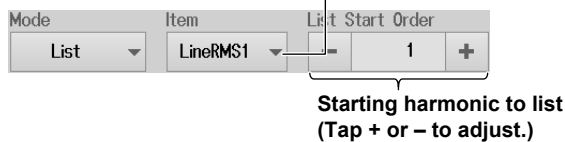

Configuring the Display (Display Setup)

5. Tap the **Display Setup** tab. The following screen appears.

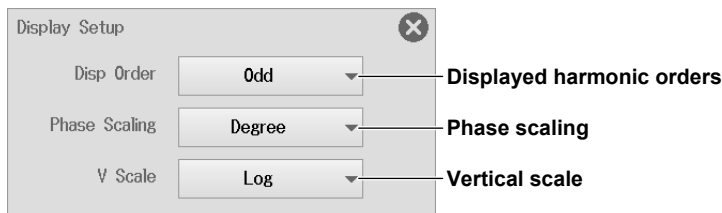

12.3 Setting the Harmonic Analysis Save Conditions

This section explains the following settings for harmonic analysis save conditions.

Items Common to Scope Mode and Recorder Mode

Unit display on/off, setting save conditions, executing the save operation

► [Features Guide: “Save Settings \(Save\)”](#)

Harmonic Analysis Save Setting Menu

1. On the waveform screen, tap **MENU > Analysis > Harmonic**. The Harmonic menu appears. At this point, harmonic analysis is automatically turned on.
2. Tap the **Save** tab.
3. Tap each item to set options and execute commands.

Turns harmonic analysis result display on and off

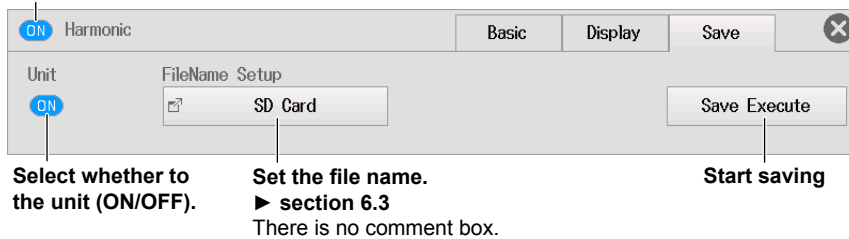

13.1 Performing GO/NO-GO Determination with Waveform Zones

This section explains the following settings for performing GO/NO-GO determination with waveform zones:

Applicable to Scope Mode

- Basic settings (GO/NO-GO determination on/off, setting the determination type to Wave Zone, determination period, linking determination periods, judgment conditions)
- Action (action mode, action settings)
- Editing waveform zones (number of the waveform zone to edit, editing the source waveform zone)

This setting is not available in recorder mode.

► [Features Guide: “GO/NO-GO Determination \(Scope mode only\)”](#)

GO/NO-GO Menu

1. On the waveform screen, tap **MENU > Analysis > GO/NO-GO**. The GO/NO-GO menu appears.

Basic Setup (Basic)

2. Tap the **Basic** tab.

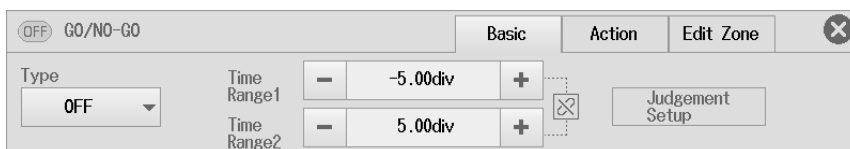

3. Tap **Type** and select Wave Zone. The GO/NO-GO determination on/off display is set to ON, and the **Judgement Setup** button is enabled.
4. Tap each item. Use the displayed list (options) or input box to set the items.

Can be set as follows within the setting range

- Retain the Time Range1 and Time Range2 interval
- Not retain the Time Range1 and Time Range2 interval

Turns GO/NO-GO determination on and off

Set the determination type to Wave Zone.

Determination period (Tap + or – to adjust.)

Set the judgment conditions.

Setting the Judgment Conditions (Judgement Setup)

5. Tap **Judgement Setup**.

• **Setting the Pattern (Pattern Setup)**

6. Tap the **Pattern Setup** tab. The following screen appears.

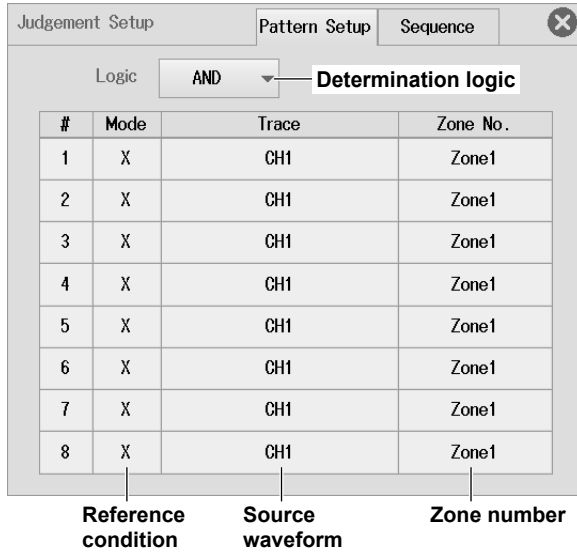

• **Sequence (Sequence)**

7. Tap the **Sequence** tab. The following screen appears.

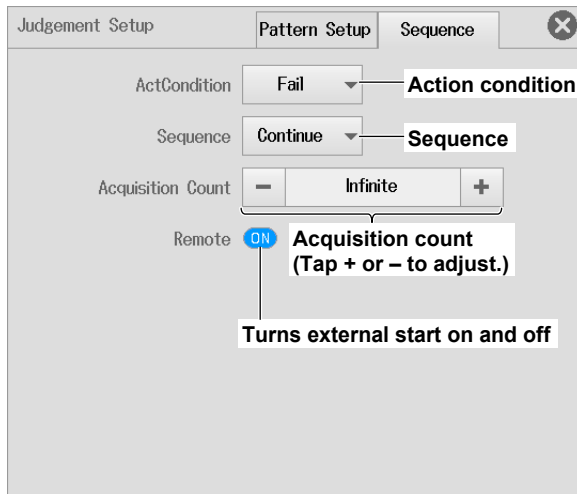

Action (Action)

2. Tap the **Action** tab. The following menu appears.
3. Tap each item to set options.

Turns GO/NO-GO determination on and off

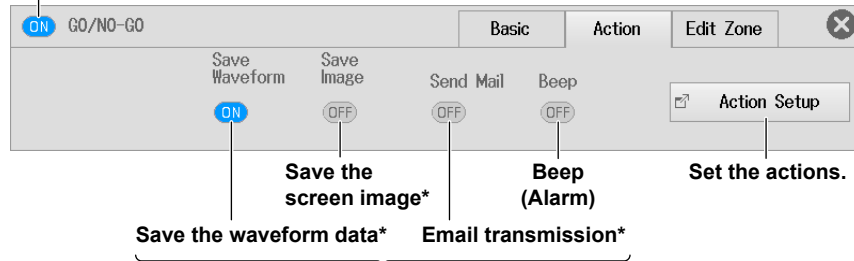

Action mode

Set the actions you want to execute to ON.

* Items other than beep can be turned on and off on the action setting screen.

Action Settings (Action Setup)

- ▶ section 3.1

Editing a Waveform Zone (Edit Zone)

You can edit waveform zones when the GO/NO-GO determination type is set to Wave Zone.

2. Tap the **Basic** tab > **Type**, and select Wave Zone.
3. Tap the **Edit Zone** tab. The following menu appears.
4. Tap the number of the waveform zone you want to edit, and select the source waveform zone.

Set GO/NO-GO determination to ON.

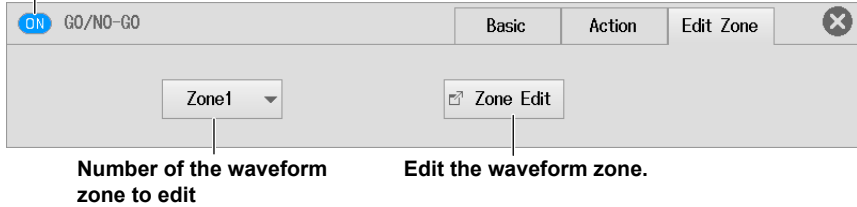

Editing the Source Waveform Zone (Zone Edit)

To perform other operations while editing a zone, tap **X** to close the zone edit menu. Settings that you are editing will be discarded.

5. Tap **Zone Edit**.
6. When you create a new waveform zone, you need to select the waveform that you will base it on (the base waveform).
Select a waveform whose display is on. The waveform zone edit items are displayed.

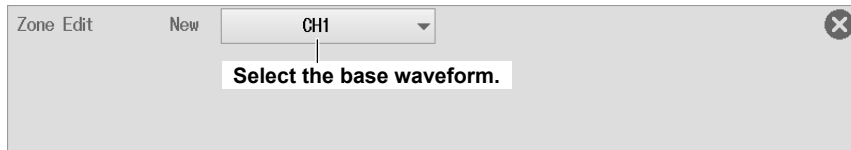

7. Tap each item. Use the displayed list (options) or input box to set the items.

• **When making the edit range the entire waveform**

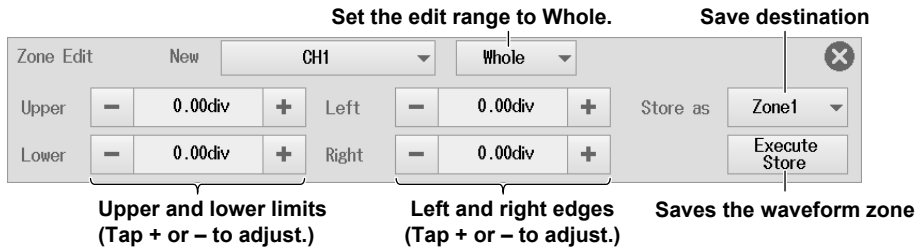

• **When making the edit range a section of the waveform**

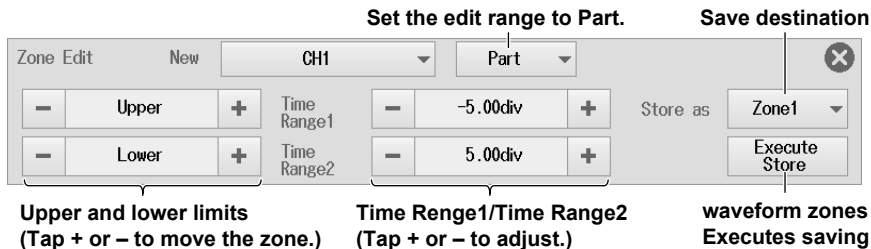

8. Tap **Execute Store**.

13.2 Performing GO/NO-GO Determination with Waveform Parameters

This section explains the following settings for performing GO/NO-GO determination with waveform parameters.

Applicable to Scope Mode

- Basic settings (GO/NO-GO determination on/off, setting the determination type to Parameter, determination period, linking determination periods, judgment conditions)
- Action (action mode, action settings)

This setting is not available in recorder mode.

► [Features Guide: "GO/NO-GO Determination \(Scope mode only\)"](#)

GO/NO-GO Menu

1. On the waveform screen, tap **MENU > Analysis > GO/NO-GO**. The GO/NO-GO menu appears.

Basic Setup (Basic)

2. Tap the **Basic** tab.

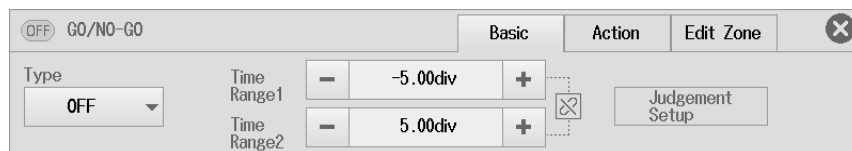

3. Tap **Type** and select **Parameter**. The GO/NO-GO determination on/off display is set to ON, and the **Judgement Setup** button is enabled.
4. Tap each item. Use the displayed list (options) or input box to set the items.

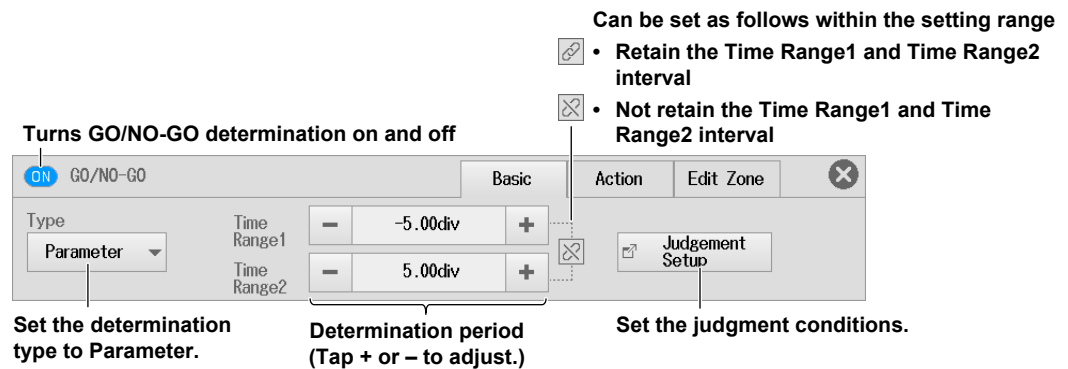

Setting the Judgment Conditions (Judgement Setup)

5. Tap **Judgement Setup**.

• Setting the Pattern (Pattern Setup)

6. Tap the **Pattern Setup** tab. The following screen appears.

Judgement Setup Pattern Setup Sequence

Logic: AND **Determination logic**

#	Mode	Trace	Item	Upper	Lower
1	X	CH1	Peak to Peak	0.0000	0.0000
2	X	CH1	Peak to Peak	0.0000	0.0000
3	X	CH1	Peak to Peak	0.0000	0.0000
4	X	CH1	Peak to Peak	0.0000	0.0000
5	X	CH1	Peak to Peak	0.0000	0.0000
6	X	CH1	Peak to Peak	0.0000	0.0000
7	X	CH1	Peak to Peak	0.0000	0.0000
8	X	CH1	Peak to Peak	0.0000	0.0000

Reference condition Source waveform **Waveform parameters**
 Upper and lower limits of the parameters

Slide to display parameters that do not fit in the screen.
 ▶ section 8.1

• Sequence (Sequence)

7. Tap the **Sequence** tab. The following screen appears.

Judgement Setup Pattern Setup Sequence

ActCondition: Fail **Action condition**

Sequence: Continue **Sequence**

Acquisition Count: - Infinite + **Acquisition count (Tap + or - to adjust.)**

Remote: ON **Turns external start on and off**

Action (Action)

▶ sections 13.1, 3.1

14.1 Setting the Waveform Zoom Range

This section explains the following settings for zooming the time scale of waveforms.

Applicable to Scope Mode

Zoom window display on/off, zoom factor (Time/div or Mag), zoom position, zoom link, display format

For recorder mode, see chapter 15.

► [Features Guide: “Waveform Zoom \(Scope mode only\)”](#)

Zoom Basic Setting Menu

1. On the waveform screen, tap **MENU > Analysis > Zoom**. The Zoom menu appears.
At this point, the Zoom1 or Zoom2 window appears automatically.
2. Tap the **Basic** tab.
3. Tap **Zoom1** or **Zoom2**, and select the target zoom window.
4. Tap each item. Use the displayed list (options) or input box to set the items.

Turns the Zoom1 window on and off

Select Zoom1.

Zoom link

- Retain the positional relationship between zoom box 1 and zoom box 2.
Retain the relative spacing between the zoom factor settings of zoom box 1 and zoom box 2.
- Not retain the positional relationship between zoom box 1 and zoom box 2.
Not retain the relative spacing between the zoom factor settings of zoom box 1 and zoom box 2.

Zoom factor of Zoom1

When the time base¹ is the internal clock signal
When the time base¹ is an external clock signal

Slide to display zoom factors that do not fit in the screen.

Zoom position of zoom box 1²
(Tap + or – to adjust.)

Display format of the Zoom1 window
Slide to display formats that do not fit in the screen.

Turns the Zoom2 window on and off

Select Zoom2.

Zoom link ► See the above figure.

Zoom factor of Zoom2

When the time base¹ is the internal clock signal
When the time base¹ is an external clock signal

Slide to display zoom factors that do not fit in the screen.

Zoom position of zoom box 2²
(Tap + or – to adjust.)

Zoom source window

Display format of the Zoom2 window
Slide to display formats that do not fit in the screen.

- 1 For time base settings, see section 3.1.
- 2 For the zoom position, set the center position of the zoom box.

14.2 Setting the Display Conditions for Waveforms

This section explains the following settings for zooming the time scale of waveforms.

Applicable to Scope Mode

Display ratio of main window, window layout, zoom source waveform, the range for performing automated measurement of waveform parameters

For recorder mode, see chapter 15.

► [Features Guide: “Waveform Zoom \(Scope mode only\)”](#)

Zoom Common Setting Menu

1. On the waveform screen, tap **MENU > Analysis > Zoom**. The Zoom menu appears.
At this point, the Zoom1 or Zoom2 window appears automatically.
2. Tap the **Common Setup** tab.
3. Tap each item. Use the displayed list (options) or input box to set the items.

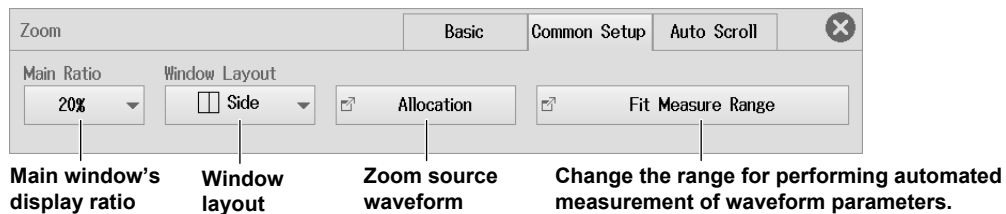

Allocating Zoom Source Waveforms (Allocation)

4. Tap **Allocation**. The following screen appears.

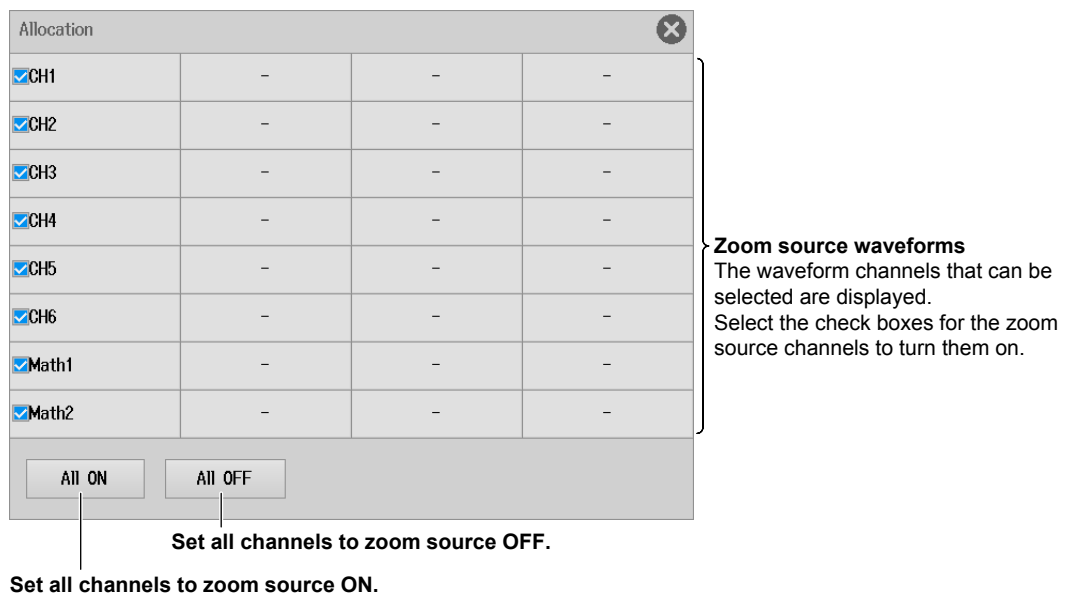

Change the Range for Performing Automated Measurement of Waveform Parameters (Fit Measure Range)

4. Tap **Fit Measure Range**. The following screen appears.

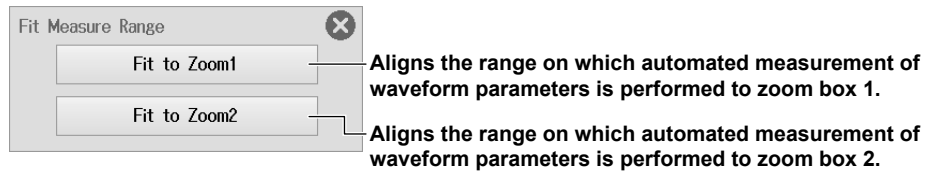

For details on the range for performing automated measurement of waveform parameters, see section 8.1.

14.3 Auto Scrolling the Zoom Position

This section explains the following settings for auto scrolling the zoom range.

Applicable to Scope Mode

Auto scroll source waveform, scroll direction, jumping to the left or right edge, scroll speed

For recorder mode, see chapter 15.

► [Features Guide: “Auto Scrolling \(Auto Scroll\)”](#)

Zoom Auto Scroll menu

1. On the waveform screen, tap **MENU** > **Analysis** > **Zoom**. The Zoom menu appears.
At this point, the Zoom1 or Zoom2 window appears automatically.
2. Tap the **Auto Scroll** tab.
3. Tap **Target**, and select Zoom1 or Zoom2.
4. Tap the appropriate buttons. The zoom position scrolls according to the buttons you tap.
To change the scroll speed, tap the **Speed** value. Use the displayed input box to set the scroll speed.

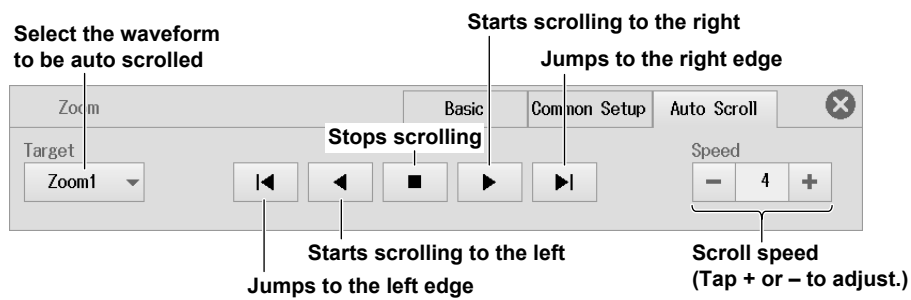

15.1 Setting the Waveform Display Range and Zoom Range

This section explains the following settings for zooming the time scale of waveforms.

Applicable to Recorder Mode

Zoom window display on/off, zoom factor (Time Range), zoom position, display format

For scope Time mode, see chapter 14.

► [Features Guide: “Waveform Display Position and Zoom \(Recorder mode only\)”](#)

Zoom Basic Setting Menu

1. On the waveform screen, tap **MENU > Analysis > Zoom**. The Zoom menu appears. At this point, a zoom window appears automatically.
2. Tap the **Basic** tab.
3. Tap each item. Use the displayed list (options) or input box to set the items.

- **When the time base¹ is the internal clock signal**

Turns the zoom window on and off

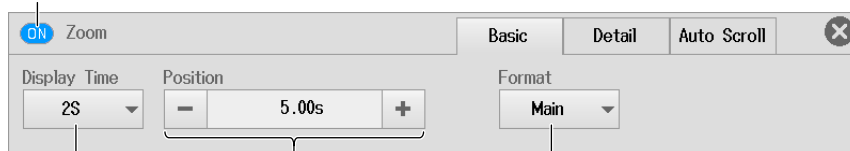

- Zoom factor
Slide to display zoom factors that do not fit in the screen.
- Zoom position²
(Tap + or – to adjust.)
- Display format of the zoom window
Slide to display formats that do not fit in the screen.

- **When the time base¹ is an external clock signal**

Turns the zoom window on and off

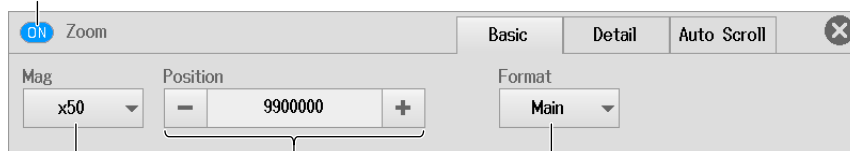

- Zoom factor
Slide to display zoom factors that do not fit in the screen.
- Zoom position²
(Tap + or – to adjust.)
- Display format of the zoom window
Slide to display formats that do not fit in the screen.

1 For time base settings, see section 3.2.
2 For the zoom position, set the center position of the zoom box.

15.2 Setting the Display Conditions for Waveforms

This section explains the following settings for zooming the time scale of waveforms.

Applicable to Recorder Mode

Zoom window display on/off, display ratio of main window, window layout, zoom source waveform, the range for performing automated measurement of waveform parameters

For scope mode, see chapter 14.

► [Features Guide: “Waveform Display Position and Zoom \(Recorder mode only\)”](#)

Zoom Detail Setting Menu

1. On the waveform screen, tap **MENU > Analysis > Zoom**. The Zoom menu appears.
At this point, a zoom window appears automatically.
2. Tap the **Detail** tab.
3. Tap each item. Use the displayed list (options) or input box to set the items.

Turns the zoom window on and off

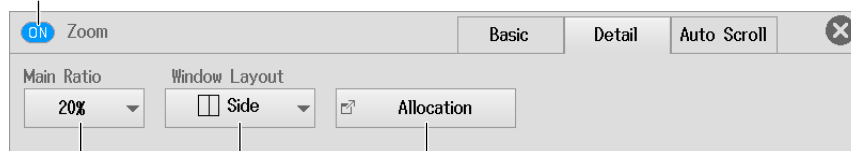

Main window's
display ratio

Window
layout

Zoom source waveforms

Allocating Zoom Source Waveforms (Allocation)

► section 14.2

15.3 Auto Scrolling the Zoom Position

This section explains the following settings for auto scrolling the zoom range.

Applicable to Recorder Mode

Scroll window display on/off, scroll direction, jumping to the left or right edge, scroll speed

For scope mode, see chapter 14.

► [Features Guide: “Auto Scrolling \(Auto Scroll\)”](#)

Zoom Auto Scroll menu

1. On the waveform screen, tap **MENU > Analysis > Zoom**. The Zoom menu appears.
At this point, a zoom window appears automatically.
2. Tap the **Auto Scroll** tab.
3. Tap the appropriate buttons. The zoom position scrolls according to the buttons you tap.
To change the scroll speed, tap the **Speed** value. Use the displayed input box to set the scroll speed.

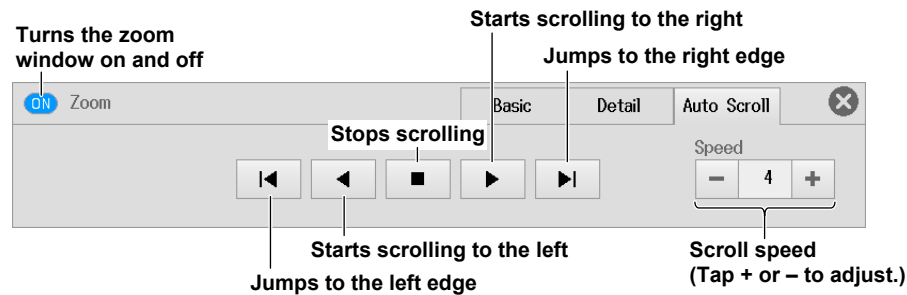

16.1 Searching for Edges

This section explains the following settings for searching for edges.

Items Common to Scope Mode and Recorder Mode

Search type, search conditions (source waveform, level for determining the state of the source waveform, edge polarity, hysteresis, and the number of times to detect the conditions), detected point number, search range (search start point and end point), executing the search

► [Features Guide: “Edge Search \(Edge\)”](#)

Search Edge Menu

1. On the waveform screen, tap **MENU > Analysis > Search**. The Search menu appears.
2. Tap **Type** and select **Edge**.
3. Tap each item. Use the displayed input box to set the items.

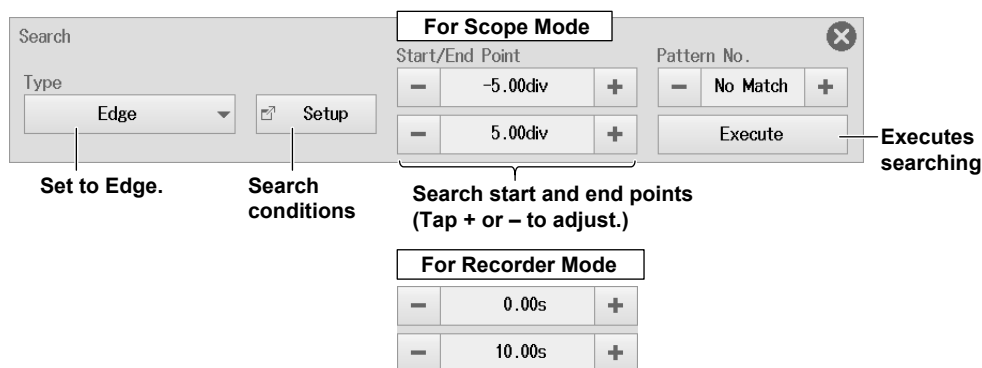

- In scope mode, the Zoom1 window is displayed automatically when you open the Search menu.
- In recorder mode, the Zoom window is not displayed automatically when you open the Search menu. For the zoom window display settings, see section 15.
- In both scope mode and recorder mode, the search target is the main window.

Setting Search Conditions (Setup)

- 4. Tap **Setup**. A menu appears according to the waveform to be searched you specified.
- 5. Tap each item. Use the displayed list (options) or input box to set the items.

If the waveform to search is set to CH1 to CH4, 16CH VOLT, 16CH TEMP/VOLT, CAN,¹ CAN FD,¹ LIN,¹ SENT,¹ GPS²

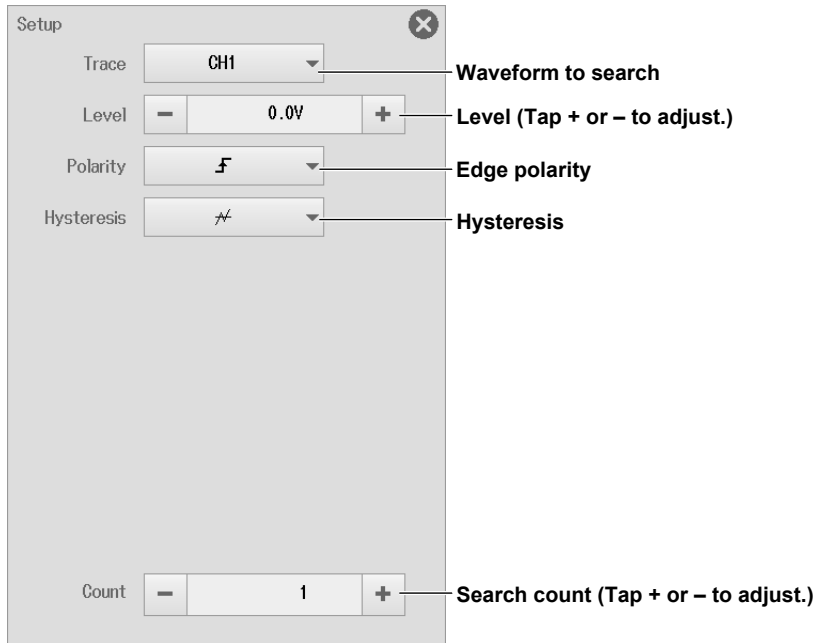

- 1 Use this menu for waveforms whose sub channel Value Type on the CAN bus monitor, CAN/CAN FD monitor, or CAN & LIN bus monitor is Unsigned, Signed, or Float and waveforms whose sub channel on the SENT monitor is FastCH, SlowCH, or Error Count.
- 2 Use this menu when the GPS feature is on and the position information is set to Latitude, Longitude, Altitude, Velocity, or Direction.

If the Waveform to Search Is Set to a Logic Channel

- For CH5 or CH6
- Waveforms of logic input modules
- Waveforms whose sub channel Value Type on the CAN bus monitor, CAN/CAN FD monitor, or CAN & LIN bus monitor is Logic
- Waveforms whose sub channel on the SENT monitor is S&C or Error Trigger
- When the GPS feature is on and the position information is set to Status

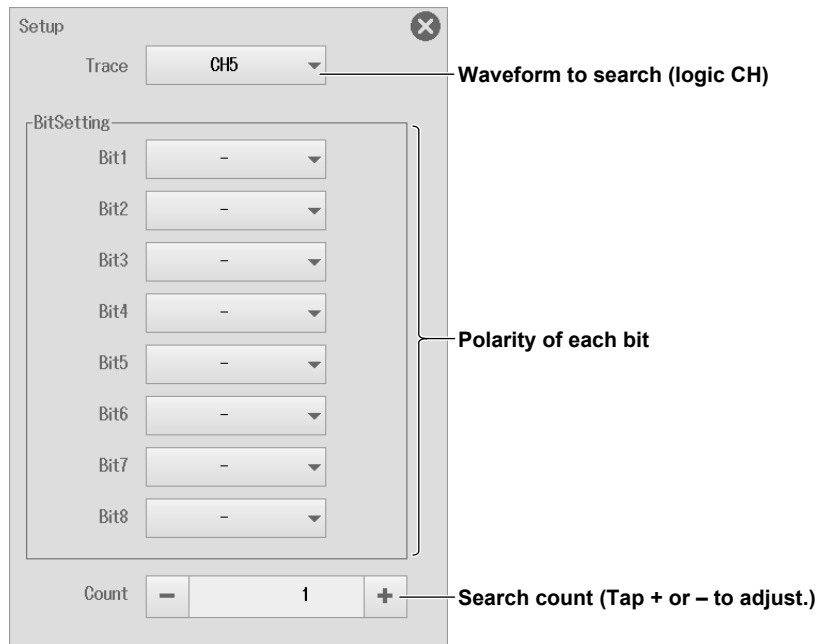

Executing a Search (Execute)

6. Tap **Execute**. The instrument searches for the search conditions. If the instrument finds points that match the search conditions (detected points), it shows numbers (0, 1, 2, etc.) from the left of the waveform display in the order that the points were detected.
7. You can set the pattern number and display the waveform with the detected point in the center of the zoom window.

The image shows a software interface for searching for edges. It is divided into two main sections: 'For Scope Mode' and 'For Recorder Mode'.
For Scope Mode: Includes a 'Type' dropdown set to 'Edge' and a 'Setup' button. Below are two 'Start/End Point' fields with values '-5.00div' and '5.00div', each with minus and plus adjustment buttons. To the right is a 'Pattern No.' field showing 'No Match' with adjustment buttons, and an 'Execute' button. A callout points to the 'Execute' button with the text 'Executes searching'.
For Recorder Mode: Includes two time-based fields with values '0.00s' and '10.00s', each with minus and plus adjustment buttons.
 Below the main interface, a callout box shows the 'Pattern No.' field set to '10' with adjustment buttons. A callout points to this field with the text 'Pattern number (Tap + or - to adjust.)'.
 An arrow points from the 'Execute' button in the 'For Scope Mode' section down to the text: 'This appears when a point that matches the specified search conditions is found.'

16.2 Searching for Events

This section explains the following settings for searching for events):

Items Common to Scope Mode and Recorder Mode

Search type, search target (event number)

► [Features Guide: “Event Search \(Event\)”](#)

Search Event Menu

1. On the waveform screen, tap **MENU** > **Analysis** > **Search**. The Search menu appears.
2. Tap **Type** and select **Event**.
3. Tap each item to set options and execute commands.

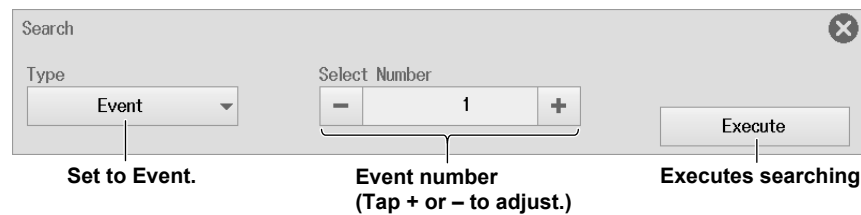

Executing a Search (Execute)

4. **Tap Execute.** The instrument displays the waveform with the selected event number in the center of the zoom window.

16.3 Searching for Logic Patterns

This section explains the following settings for searching for logic patterns):

Items Common to Scope Mode and Recorder Mode

Search type, search conditions (source waveform, source bits, and the number of times to detect the conditions)

► [Features Guide: “Logic Pattern Search \(Logic Pattern\)”](#)

Search Logic Pattern Menu

1. On the waveform screen, tap **MENU** > **Analysis** > **Search**. The Search menu appears.
2. Tap **Type** and select **Logic Pattern**.
3. Tap each item. Use the displayed input box to set the items.

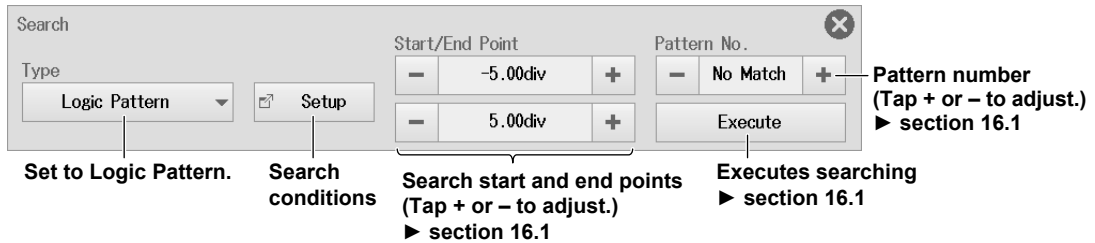

Setting Search Conditions (Setup)

4. Tap **Setup**. The Setup screen appears.
5. Tap each item. Use the displayed list (options) or input box to set the items.

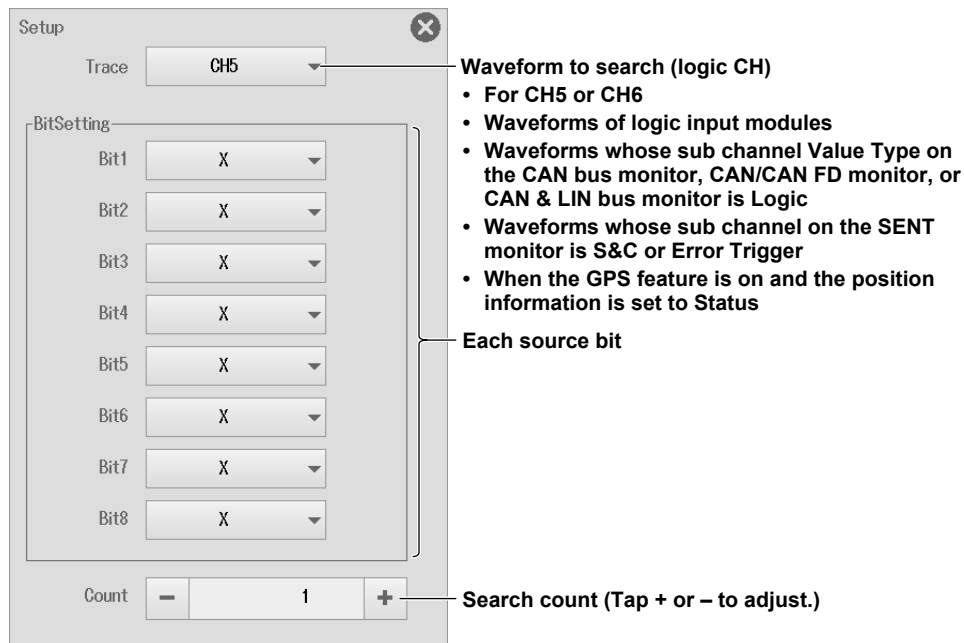

16.4 Searching for a Specific Date and Time

This section explains the following settings for searching for a specific date and time.

Items Common to Scope Mode and Recorder Mode

Search type, search target (date and time)

► [Features Guide: "Time Search \(Time\)"](#)

Search Time Menu

1. On the waveform screen, tap **MENU** > **Analysis** > **Search**. The Search menu appears.
2. Tap **Type** and select **Time**.
3. Tap each item to set options and execute commands.

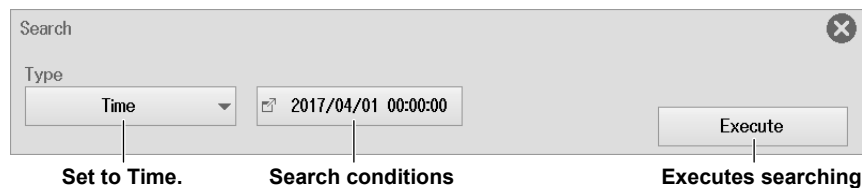

Setting Search Conditions

4. Tap **yyyy/mm/dd hh:mm:ss**. * The Setup screen appears.
* The set date and time appear.
5. Tap each item. Use the displayed input box to set the items.

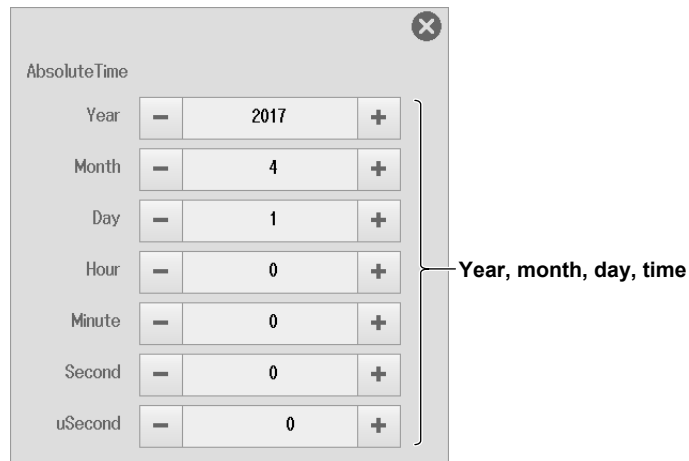

Executing a Search (Execute)

6. Tap **Execute**. The waveform is displayed in the zoom window with the specified time at the center.

17.1 Displaying Waveform History Waveforms

This section explains the following settings for displaying history waveforms, which are waveforms that were previously saved to acquisition memory.

Applicable to Scope Mode

Display mode, highlight display (selected record number), display range (start and end numbers), displaying a list of timestamps, clearing all history waveforms

These settings are not available in recorder mode.

► [Features Guide: “History Waveform Display \(Scope mode only\)”](#)

History Menu

1. On the waveform screen, tap **MENU** > **Analysis** > **History**. The History menu appears.
2. Tap each item. Use the displayed list (options) or input box to set the items.

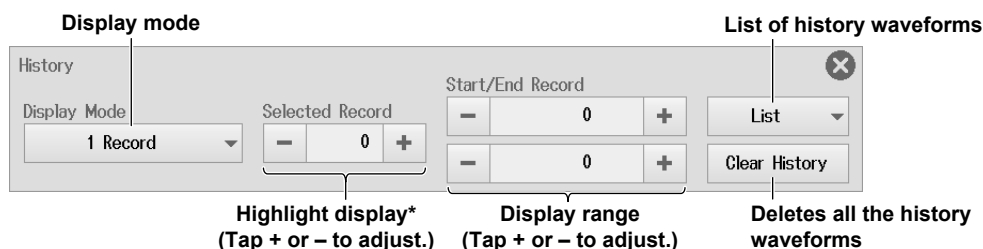

* This setting only appears when Display Mode is set to 1 Record or All Record.

Setting the Display Mode (Display Mode)

- 1 Record: Only the waveform corresponding to the selected record number is displayed.¹
- All Record: All selected waveforms are superimposed on each other.² All other waveforms¹ are displayed with an intermediate color.
- Average Record: All selected waveforms² are linearly averaged and displayed.
- 1 Specify the highlighted waveform with Selected Record.
 - 2 Specify with Start and End Record.

Note

The averaging feature requires a certain amount of acquisition memory. If this is not available, you will not be able to display the Average Record.

List of History Waveforms (List)

3. Tap **List**. The following screen appears.

Tapping the data selected from the list displays the corresponding waveform.

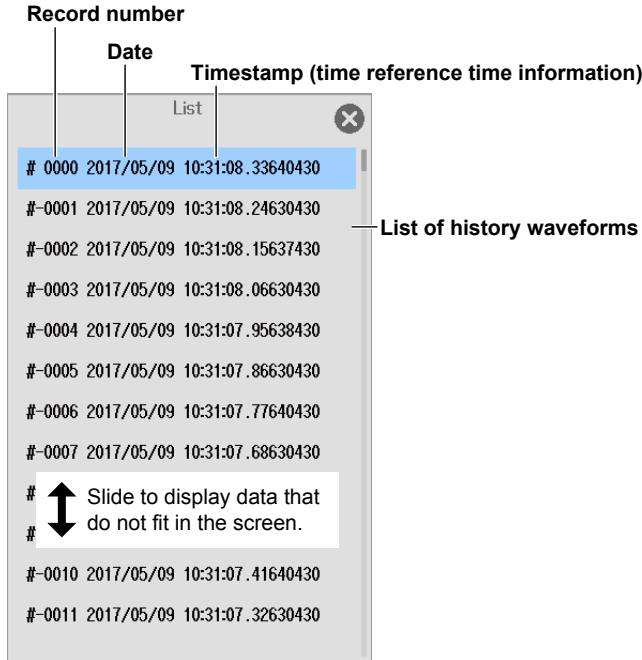

Note

Notes on Using the History Feature

- When the acquisition mode is set to Average, you cannot use the history feature.
- You cannot use the history feature when SD recording is being executed.
- If you stop waveform acquisition, even if one complete screen's worth of waveform data has not been acquired, the waveform at which the trigger occurred is displayed as a single history waveform.
- You can start waveform acquisition when the History menu is displayed. However, you cannot change the history feature settings while waveform acquisition is in progress.
- The settings are restricted so that the following relationship is retained: Last record (End Record) \leq Selected Record \leq first record (Start Record).
- When you load waveform data from the specified storage medium, history waveforms up to that point are cleared. The loaded waveform data is placed in record number zero. If you load a file containing multiple history waveforms, the latest waveform is placed in zero, and earlier waveforms are placed in order to record numbers -1, -2, and so on.
- Computation and automated measurement of waveform parameters are performed on the waveform of the record number specified by Selected Record. You can analyze old data as long as you do not overwrite the acquisition memory contents by restarting waveform acquisition. If Display Mode is set to Average Record, analysis is performed on the averaged waveform.
- History waveforms are cleared when you turn the power off.

18.1 Acquiring Position Information

This section explains the following settings for acquiring position information with the GPS (Global Positioning System).

Items Common to Scope Mode and Recorder Mode

Position information acquisition on/off, time synchronization feature on/off, time difference between the time obtained from the GPS and the time of the region that this instrument is used in

► [Features Guide: "Position Information \(GPS\)"](#)

GPS Menu

1. On the waveform screen, tap **MENU > Analysis > GPS**. The GPS menu appears.
2. Tap each item to set options and execute commands.

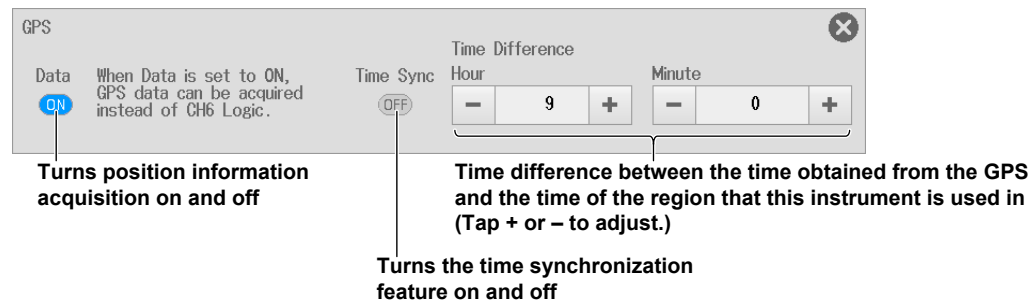

19.1 Connecting the Instrument to a Network

This section explains how to connect the instrument to a network.

Ethernet Interface Specifications

There is an Ethernet port located on the side panel of the instrument.

Item	Specifications
Ports	1
Electrical and mechanical	IEEE802.3 compliant
Transmission system	Ethernet(100BASE-TX/10BASE-T)
Communication protocol	TCP/IP
Supported services	Server: HTTP (Web) and VXI-11 Client: FTP (Net Drive), SMTP (mail), SNMP, DHCP, and DNS
Connector type	RJ-45 modular jack

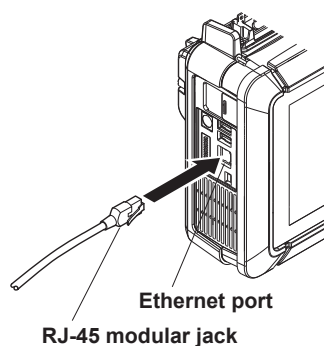

Items Required to Connect the Instrument to a Network

Cable

Use one of the following types of network cable that conforms to the transfer speed of your network.

- A UTP (Unshielded Twisted-Pair) cable
- An STP (Shielded Twisted-Pair) cable

Connection Method

To Connect to a PC over a Network

1. Turn off the instrument.
2. Connect one end of a UTP (or STP) cable to the Ethernet port on the side panel.
3. Connect the other end of the UTP (or STP) cable to a hub or router.
4. Turn on the instrument.

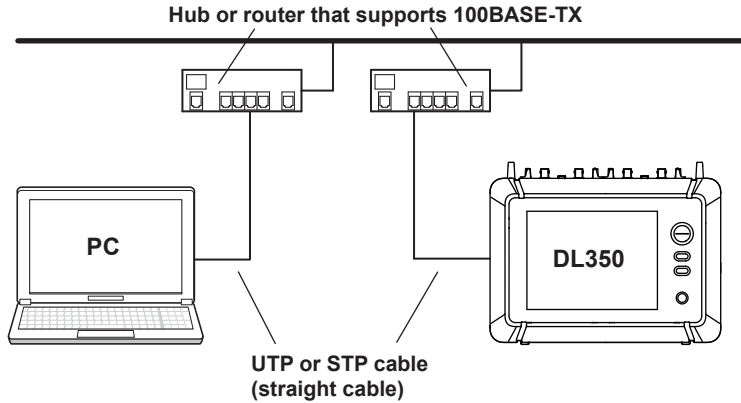

To Connect to a PC through a Hub or Router

1. Turn off the instrument and the PC.
2. Connect one end of a UTP (or STP) cable to the port on the side panel.
3. Connect the other end of the UTP (or STP) cable to a hub or router.
4. Connect the PC to the hub or router in the same way.
5. Turn on the instrument.

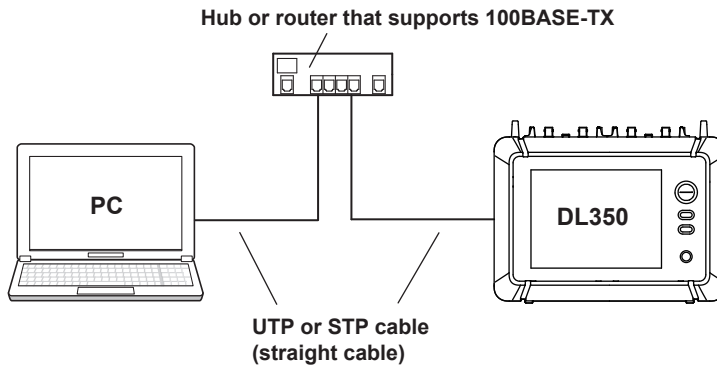

Note

- Use a hub or router that conforms to the transfer speed of your network.
 - When you connect a PC to the instrument through a hub or router, the PC must be equipped with an auto switching 100BASE-TX/10BASE-T network card.
 - Do not connect the instrument to a PC directly. Direct communication without a hub or router is not guaranteed to work.
 - If you specify a fixed IP address or network drive, be sure to use the instrument in an environment where it can be accessed. If it cannot be accessed, you may not be able to operate the instrument for the specified timeout period.
-

19.2 Configuring TCP/IP Settings

This section explains the following TCP/IP settings for connecting to a network.

Items Common to Scope Mode and Recorder Mode

- DHCP (IP address, subnet mask, and default gateway)
- DNS (domain name, DNS server IP address, and domain suffix)

► [Features Guide: "TCP/IP \(TCP/IP\)"](#)

Utility Network Menu

1. On the waveform screen, tap **MENU > Utility > Network**. A network screen appears.

Configuring TCP/IP Settings (TCP/IP)

2. Tap the **TCP/IP** tab.
3. Tap each item. Use the displayed list (options) or input box to set the items.

The screenshot shows the TCP/IP configuration screen with the following settings and annotations:

- Network** tab selected.
- DHCP** is set to **OFF**. Annotation: "Turns DHCP on and off".
- IP Address**: 192 . 168 . 0 . 100. Annotation: "Set these when DHCP is set to OFF. When set to ON, you cannot set these items."
- Subnet Mask**: 255 . 255 . 255 . 0. Annotation: "• IP address, • Subnet mask, • Default gateway"
- Default Gateway**: 192 . 168 . 0 . 1.
- DNS** is set to **ON**. Annotation: "Set the DNS (OFF, ON, Auto).* * Auto is displayed when DHCP is turned on."
- Domain Name**: [Empty]. Annotation: "Set these when DNS is set to ON. When set to Auto or OFF, you cannot set these items."
- DNS Server1**: 0 . 0 . 0 . 0. Annotation: "• Domain name, • DNS server IP addresses (primary, secondary)"
- DNS Server2**: 0 . 0 . 0 . 0.
- Domain Suffix1**: [Empty]. Annotation: "Set these when DNS is set to ON or Auto. When set to OFF, you cannot set these items."
- Domain Suffix2**: [Empty]. Annotation: "• Domain suffixes (primary and secondary)"
- Bind** button. Annotation: "Apply the settings."

DNS Settings (DNS)

OFF: DNS is disabled.

ON: DNS is enabled. Set the domain name, and the DNS server's primary and secondary IP addresses and domain suffixes.

Auto: DNS is enabled. Set the domain suffix. The domain name and the DNS server IP addresses are set automatically. This option can only be selected when DHCP is on.

19.3 Monitoring the Instrument's Display from a PC (Web Server)

This section explains the following settings for connecting to the instrument from a PC over a network to show the instrument's display on the PC and to start and stop waveform acquisition from the PC:

Items Common to Scope Mode and Recorder Mode

User name, password, timeout period, connecting from a PC

► [Features Guide: "Web Server \(Web Server\)"](#)

Utility Network Menu

1. On the waveform screen, tap **MENU > Utility > Network**. A network screen appears.

Configuring the Web Server (Web Server)

2. Tap the **Web Server** tab.
3. Tap each item. Use the input box to set the items.

The screenshot shows the 'Web server' configuration screen. At the top, there are tabs for 'Network', 'TCP/IP', 'Web server', 'Mail', 'Net Drive', and 'SNTP'. The 'Web server' tab is selected. The screen contains the following fields and controls:

- User Name:** An input field containing the text 'anonymous'. A callout box points to this field with the text: 'Settings for accessing the instrument from a PC' and '• User name (up to 15 characters)'.
- Password:** An empty input field. A callout box points to this field with the text: '• Password (up to 15 characters)'.
- TimeOut(sec):** A numeric keypad with a minus sign on the left, the number '1800' in the center, and a plus sign on the right. A callout box points to this field with the text: '• Timeout period (Tap + or - to adjust.)'.
- Entry:** A button at the bottom center. A callout box points to this button with the text: 'Apply the settings.'

19.4 Connecting to a Network Drive

This section explains the following settings for accessing a network drive through an Ethernet connection to load or save various instrument's data.

Items Common to Scope Mode and Recorder Mode

FTP server (file server), login name, password, FTP passive mode on/off, timeout period, connecting/disconnecting from the network drive

► [Features Guide: "Network Drive \(Net Drive\)"](#)

Utility Network Menu

1. On the waveform screen, tap **MENU > Utility > Network**. A network screen appears.

Configuring a Network Drive and Connecting to It (Net Drive)

2. Tap the **Net Drive** tab.
3. Tap each item. Use the displayed input box to set the items.

The screenshot shows the 'Net Drive' configuration screen with the following fields and callouts:

- FTP Server**: Input box for the FTP server address. Callout: "Settings used to connect to a network drive" and "• FTP server (IP address, or when DNS is enabled, the host name and domain name)".
- LoginName**: Input box containing "anonymous". Callout: "• Login name (up to 15 characters)".
- Password**: Input box for the password. Callout: "• Password (up to 15 characters)".
- Passive**: Toggle switch set to "ON". Callout: "• FTP passive mode on/off".
- TimeOut(sec)**: Spinners showing "15". Callout: "• Timeout period (Tap + or - to adjust.)".
- Connect** button: Callout: "Connects to the network drive".
- Disconnect** button: Callout: "Disconnects from the network drive".

19.5 Configuring Mail Transmission (SMTP client)

This section explains the following settings for transmitting mail to a specified mail address on a network.

Items Common to Scope Mode and Recorder Mode

Mail server, mail transmission destination address, comment, image data attachment, timeout period, mail test transmission

► [Features Guide: “Mail \(Mail\)”](#)

Utility Network Menu

1. On the waveform screen, tap **MENU > Utility > Network**. A network screen appears.

Configuring Mail (Mail)

2. Tap the **Mail** tab.
3. Tap each item. Use the displayed input box to set the items.

The screenshot shows the 'Mail' configuration screen. At the top, there are tabs for 'Network', 'TCP/IP', 'Web server', 'Mail', 'Net Drive', 'SNTP', and 'VXI11'. The 'Mail' tab is selected. Below the tabs are several input fields and controls:

- Mail Server**: An input box for the mail server address. Callout: "Mail server (IP address, or when DNS is enabled, the host name and domain name)".
- Mail Address**: An input box for the mail destination address. Callout: "Mail address".
- Comment**: An input box for a comment. Callout: "Comment".
- Attached Image File**: A toggle switch currently set to 'OFF'. Callout: "Turns image data attachment on and off".
- TimeOut(sec)**: A numeric input field with a value of '15' and minus/plus buttons. Callout: "Timeout period (Tap + or - to adjust.)".
- Send Test Mail**: A button to send a test mail. Callout: "Sets a test mail".

19.6 Using SNTP to Set the Date and Time

This section explains how to use SNTP to set the Instrument's date and time.

Items Common to Scope Mode and Recorder Mode

SNTP server, timeout period, auto adjustment on/off, time adjustment

► [Features Guide: "SNTP \(SNTP\)"](#)

Utility Network Menu

1. On the waveform screen, tap **MENU > Utility > Network**. A network screen appears.

Configuring SNTP Settings (SNTP)

2. Tap the **SNTP** tab.
3. Tap each item. Use the displayed input box to set the items.

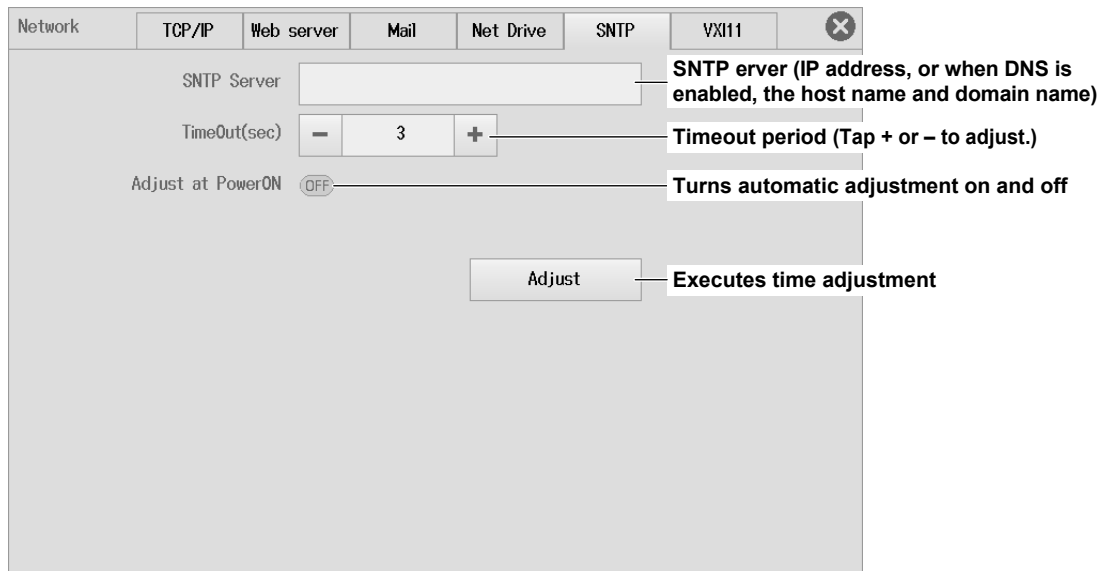

19.7 Configuring the VXI-11

This section explains how to set the timeout period for when there is no access to the instrument when the instrument is connected to the network using VXI-11.

Items Common to Scope Mode and Recorder Mode

Timeout period

► [Features Guide “VXI11 \(VXI11\)”](#)

Utility Network Menu

1. On the waveform screen, tap **MENU > Utility > Network**. A network screen appears.
2. Tap the **VXI11** tab.
3. Tap **Time Out**. Use the displayed input box to set the timeout period.

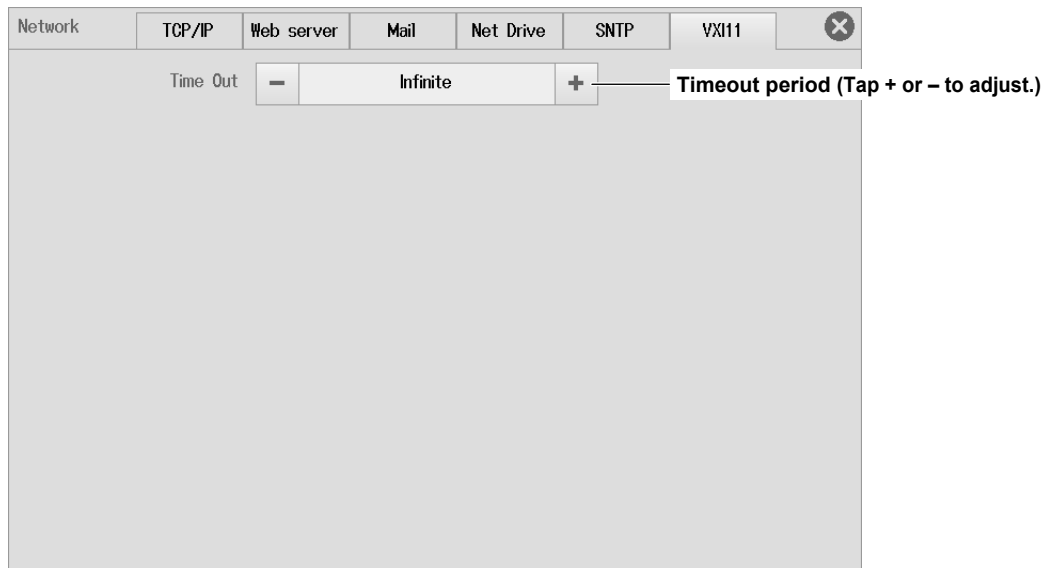

20.1 Setting the Date and Time

For details on setting the date and time, see the *Getting Started Guide*, IM DL350-03EN.

20.2 Configuring the LCD

This section explains the following settings for adjusting the LCD.

Items Common to Scope Mode and Recorder Mode

LCD off, LCD auto-off on/off, auto-off time, adjusting the brightness

► [Features Guide: “System Configuration \(System Configuration\)”](#)

Utility System Menu

1. On the waveform screen, tap **MENU > Utility > System**. The System Setup screen appears.

Configuring the LCD (LCD Setup)

2. Tap the **LCD Setup** tab.
3. Tap each item. Use the displayed list (options) or input box to set the items.

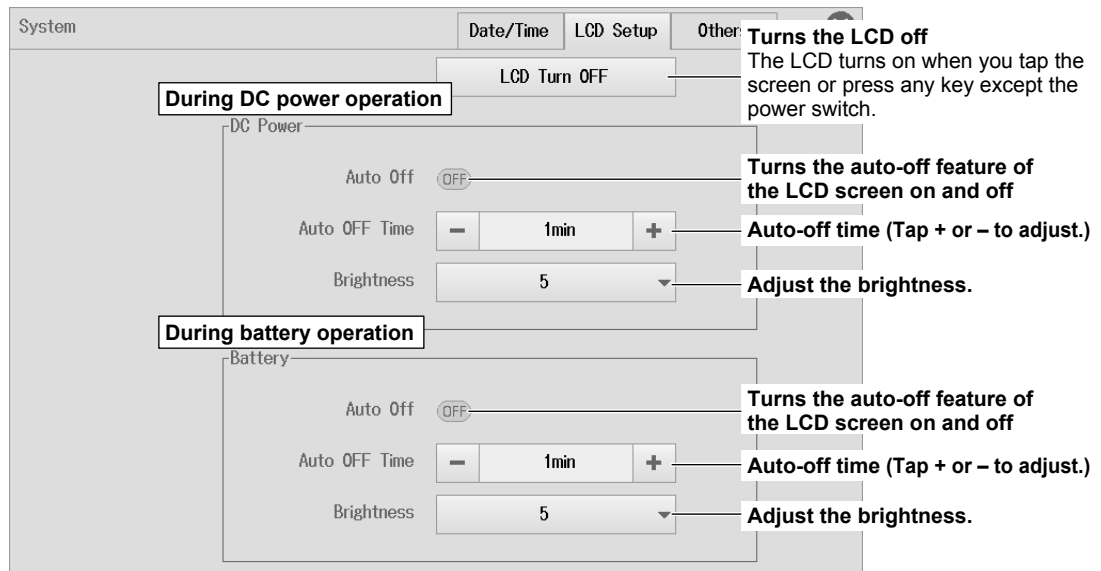

20.3 Setting the Message Language, Menu Language, and USB

This section explains the following language and USB communication feature settings.

Items Common to Scope Mode and Recorder Mode

Message language, menu language, USB communication feature, USB keyboard language, USB keyboard input

► [Features Guide: “System Configuration \(System Configuration\)”](#)

Utility System Menu

1. On the waveform screen, tap **MENU > Utility > System**. The System Setup screen appears.

Setting the Language, USB Communication Feature, USB Keyboard (Others)

2. Tap the **Others** tab.
3. Tap each item. Use the displayed list (options) to set the items.

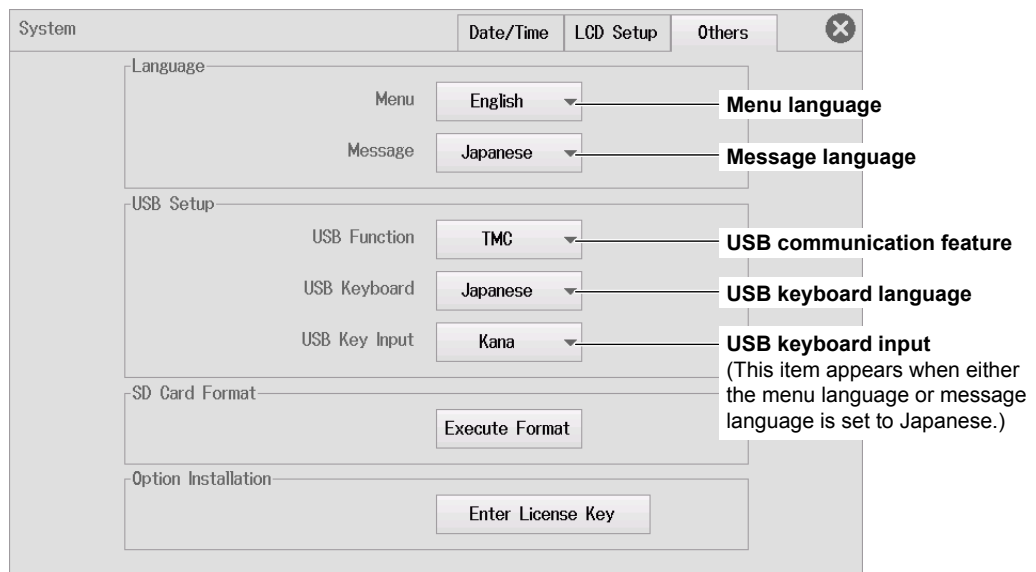

20.4 Adding Options to the DL350

For details on how to add options, see the Getting Started Guide (IM DL350-03EN).

20.5 Setting Preferences

This section explains the following settings.

Items Common to Scope Mode and Recorder Mode

- Logic (logic channel display method, cursor reading order, bit data display order)
- Terminal (enabling or disabling the remote signal high edge (STOP), trigger output signal)
- Key, touch (start/stop key response time, touch lock)
- Menu (color theme, channel information, custom menu)
- Others (cursor read mode, data save destination upon action execution, backup at power-off on/off, beep on error on/off)

► [Features Guide: “Environment Settings \(Preference\)”](#)

Utility Preference Menu (Preference)

1. On the waveform screen, tap **MENU > Utility > Preference**. The Environmental setting window appears.

Configuring the Logic Settings (Logic Setup)

2. Tap the **Logic Setup** tab.
3. Tap each item. Use the displayed list (options) to set the items.

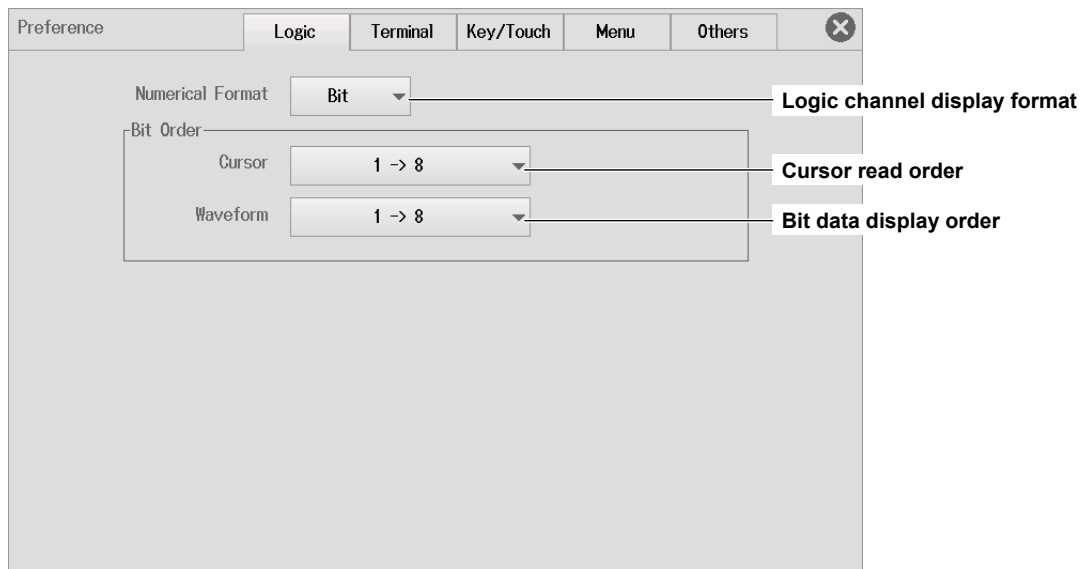

Configuring the External I/O Terminal Settings (Terminal Setup)

2. Tap the **Terminal Setup** tab.
3. Tap each item to set options and execute commands.



When the Terminal Output Signal Is Set to Pulse

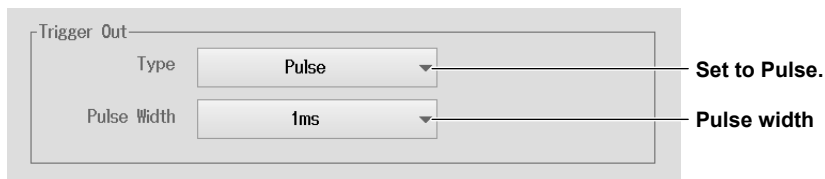

When the Terminal Output Signal Is Set to Sample Pulse

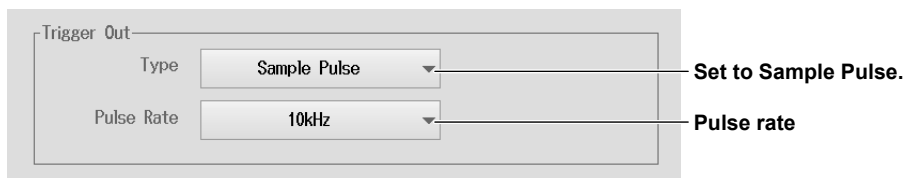

List that appears when you tap Pulse Rate

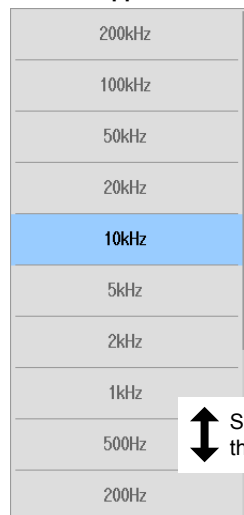

* You cannot specify a frequency that is faster than the instrument's sample rate (main channel sample rate). The pulse rate must be set so that the instrument's sample rate is an integer multiple of the pulse rate. You may not be able to use the pulse rate that you select depending on the combination of the pulse rate and the instrument's sample rate.

Slide to display pulse rates that do not fit in the screen.

Setting the Start/Stop Key Response Time and Key/Touch Lock (Key/Touch)

2. Tap the **Key/Touch** tab.
3. Tap each item. Use the displayed list (options) or input box to set the items.

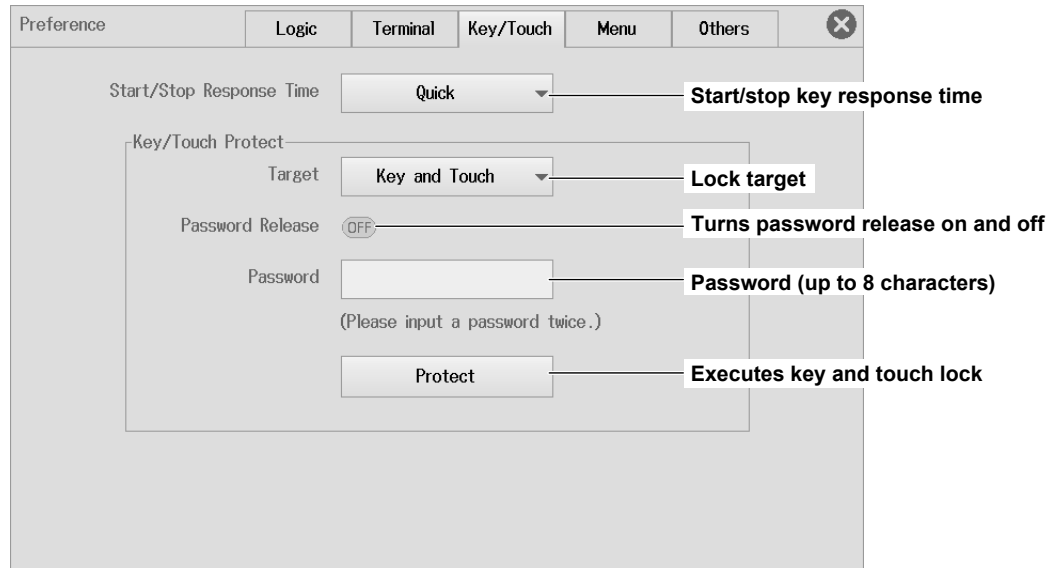

Setting the Color Theme, Channel Information, and Custom Menu

2. Tap the **Menu** tab.
3. Tap each item. Use the displayed list (options) to set the items.

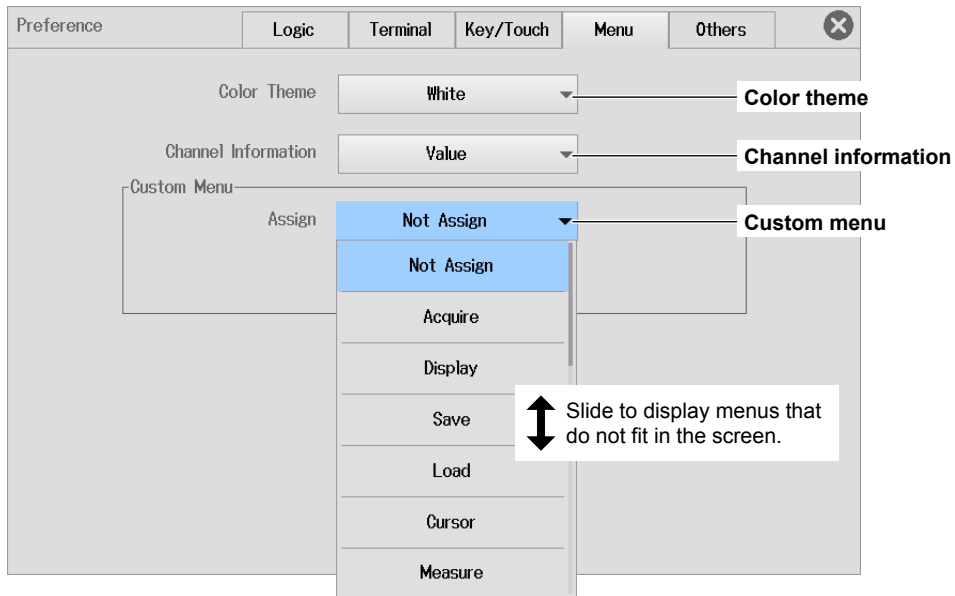

List that appears when you tap Custom Menu
 The custom menu list varies depending on the operation mode (scope mode or recorder mode).

When Custom Menu Is Set to Save



When Custom Menu Is Set to Load

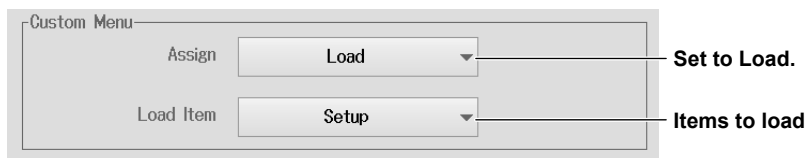

Cursor Read Mode, Data Save Destination Upon Action Execution, Backup at Power-Off , Beep on Error (Others)

2. Tap the **Others** tab.
3. Tap each item to set options.

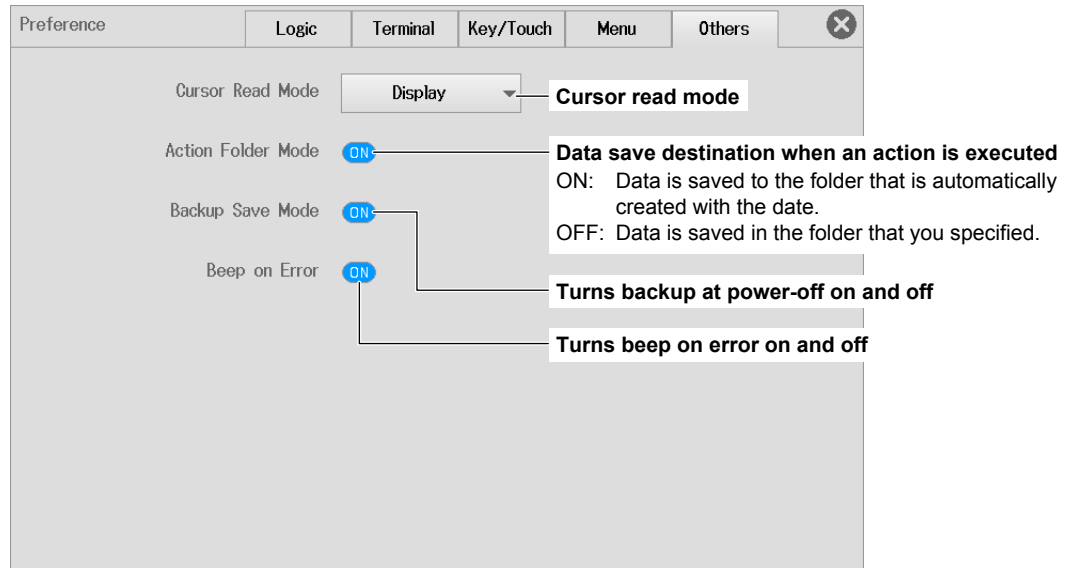

Index

A	Page	D	Page
achievement condition (AND trigger).....	4-14	data save destination upon action execution.....	20-9
acquisition mode (recorder).....	3-8	data type to load.....	6-23
acquisition mode (scope).....	3-1	date and time.....	4-5
action conditions.....	13-2	definitions file (CAN/CAN FD).....	2-39
action (GO/NO-GO).....	13-3	definitions file (LIN).....	2-44
action settings.....	3-3	determination mode (period trigger).....	4-17
all sub channel Factor/Offset (CAN, CAN FD).....	2-37	determination mode (pulse width trigger).....	4-19
all sub channel Factor/Offset (LIN).....	2-44	display format.....	6-26
all sub channel Factor/Offset (SENT).....	2-49	Display menu (auto scroll).....	5-9
all sub channel settings (CAN, CAN FD).....	2-37	Display menu (display group, format).....	5-1
all sub channel settings (LIN).....	2-43	Display menu (display preferences).....	5-4
all sub channel settings (SENT).....	2-48	Display menu (display range, display position).....	5-8
automated measurement of waveform parameters (saving).....	6-12	Display menu (snapshot, clear trace).....	5-7
auto naming.....	6-6	Display menu (waveform arrangement, color, grouping).....	5-2
auto setup.....	1-9	display mode (history).....	17-1
Auto (trigger mode).....	4-1	DNS.....	19-3
		drag.....	iv
		duty ratio (frequency module).....	2-30
B	Page	E	Page
backup at power-off.....	20-9	edge detection condition (OR trigger).....	4-12
B Between (determination mode).....	4-19	error channel settings (SENT).....	2-47
beep on error.....	20-9	Ethernet interface specifications.....	19-1
bit settings.....	2-35	external I/O terminal.....	20-6
B < Time (determination mode).....	4-19		
B > Time (determination mode).....	4-19		
B TimeOut (determination mode).....	4-19		
C	Page	F	Page
cable.....	19-1	factory default settings, initializing to.....	1-8
calibration.....	1-10	FFT analysis results (saving).....	6-14
CAN/CAN FD data definition file.....	2-39	FFT Common setting menu.....	10-1, 10-2
CAN or CAN FD data conversion conditions.....	2-37	FFT Cursor menu.....	10-6
CAN or CAN FD data extraction conditions.....	2-37	FFT Horizontal menu.....	10-9
channel selection.....	1-5	FFT Save menu.....	10-4
channel setting menu (acceleration).....	2-24	file and folders, deleting.....	6-30
channel setting menu (CAN, CAN FD).....	2-36	file information.....	6-28
channel setting menu (frequency).....	2-27	file name.....	6-5
channel setting menu (GPS).....	2-51	file operation screen.....	6-24
channel setting menu (LIN).....	2-42	files and folders, copying.....	6-32
channel setting menu (logic signal).....	2-34	files and folders, moving.....	6-33
channel setting menu (SENT).....	2-46	files and folders, renaming.....	6-31
channel setting menu (strain).....	2-22	folders (directories), creating.....	6-29
channel setting menu (temperature).....	2-15	format (SD card).....	6-4
channel setting menu (voltage).....	2-4	frame settings (LIN).....	2-43
character strings, entering.....	vi	frequency (frequency module).....	2-28
color theme.....	20-8		
comment.....	6-6		
connection, items required.....	19-1		
connection procedure.....	19-2		
Cursor Degree menu.....	7-5		
Cursor Horizontal menu.....	7-1		
Cursor H & V menu.....	7-7		
Cursor Marker menu.....	7-3		
cursor read mode.....	20-9		
Cursor Vertical menu.....	7-2		
custom menu.....	20-8		
cycle trace.....	8-6		
		G	Page
		GO/NO-GO menu (waveform parameter).....	13-5
		GO/NO-GO menu (waveform zone).....	13-1
		GPS menu.....	18-1
		H	Page
		hard copy.....	6-16
		harmonic analysis results (saving).....	6-14
		Harmonic Basic setting menu.....	12-1
		Harmonic Display setting menu.....	12-3
		Harmonic Save setting menu.....	12-4
		history map.....	17-2
		History menu.....	17-1

Index

I	Page
initialization	1-8
input box	v
input conditions	2-32
input coupling	2-5
input coupling (ACCEL)	2-25
input coupling (TC)	2-15
input settings (SENT)	2-47

K	Page
keyboard, operating	vi
key/touch lock	20-7

L	Page
language	20-3
LCD settings	20-2
LIN data conversion conditions	2-44
LIN data definition file	2-44
LIN data extraction conditions	2-43
linear scaling	2-7
linear scaling (all channels)	2-2
linear scaling (all sub channels of temperature/voltage)	2-19
linear scaling (all sub channels of voltage)	2-12
list sorting	6-25
logic	20-5
long print	6-17

M	Page
mail	19-6
marker settings (FFT)	10-3, 10-7
marker settings (T-Y)	7-4
Math Basic setting menu	9-1
Math Common setting menu	9-6
Math Display setting menu	9-5
Measure automated measurement results save menu	8-9
Measure Basic setting menu	8-1
Measure continuous statistics menu	8-5
Measure Cycle statistics menu	8-6
Measure history waveform statistics menu	8-8
medium (drive), changing	6-25
menu (channel information)	20-8

N	Page
navigation screen (easy setup)	1-4
navigation screen (recorder/scope)	1-1
navigation screen (setup file)	1-2
network drive	19-5
Normal (trigger mode)	4-1
numeric keypad	v

O	Page
One shot	2-40
one-shot output	2-40
On Start (trigger mode)	4-1
options, adding	20-4

P	Page
pattern number	16-4
period (frequency module)	2-29
pinch in	iv
pinch out	iv
port settings (CAN, CAN FD)	2-38
power frequency (frequency module)	2-30
preset items	2-32

probe	2-6
pulse integration (frequency module)	2-31
pulse width (frequency module)	2-30

R	Page
range unit	2-23
recorder mode	1-1
recording channels, turning on and off	1-5
record time	1-6
revolution rpm (frequency module)	2-28
revolution rps (frequency module)	2-29

S	Page
sample interval	1-7
save conditions (images)	6-13
save conditions (waveforms)	6-7
save destination	6-6
save, executing	6-14
Save/Load Others Load menu	6-22
Save/Load Others Save menu	6-11
Save/Load Save Key Setup menu	6-15
Save/Load Setup Load menu	6-21
Save/Load Setup Save menu	6-10
Save/Load Symbol Load menu	6-23
Save/Load Waveform Load menu	6-20
Save/Load Waveform Save menu	6-5
save (SAVE key)	6-18
save type	6-11
SBL file (CAN/CAN FD)	2-39
SBL file (LIN)	2-44
scope mode	1-1
screen image (saving)	6-13
SD memory card	6-1
SD recording	3-4
search	16-4, 16-5, 16-7
search conditions	16-2, 16-6, 16-7
Search Edge menu	16-1
Search Event menu	16-5
Search Logic Pattern menu	16-6
Search Time menu	16-7
select all, unselect all (Select All/Deselect All)	6-34
SENT data conversion conditions	2-49
SENT data extraction conditions	2-48
SENT format	2-47
setup data loading	6-21
setup data, saving	6-10
Single (trigger mode)	4-1
slide	iv
snapshot (saving)	6-12
SNTP	19-7
source waveform (X-Y waveform)	11-1
start/stop key response time	20-7
state condition (Edge On A trigger)	4-11
state condition (period trigger)	4-16
state condition (pulse width trigger)	4-18
sub channel display (CAN, CAN FD)	2-39
sub channel display (LIN)	2-45
sub channel display (SENT)	2-50
sub channel setting menu (16-CH voltage)	2-10, 2-17
swipe	iv
symbol file (CAN)	2-39
symbol file (LIN)	2-44

T	Page
T1 < T < T2 (determination mode)	4-17
tap	iv
TCP/IP	19-3

time base (recorder)	3-8	waveform acquisition (trigger position, delay)	4-2
time base (scope)	3-2	waveform acquisition (wave window trigger)	4-20
touch panel operations	iv	waveform, clearing	6-23
trigger condition (AND trigger)	4-14	waveform data loading	6-20
trigger condition (Edge On A trigger)	4-11	waveform vertical position	2-9
trigger condition (OR trigger)	4-12	waveform zone, editing	13-4
trigger condition (period trigger)	4-16	Web server	19-4
trigger condition (pulse width trigger)	4-18		
trigger condition (wave window trigger)	4-20	X	Page
trigger delay	4-2	X-Y Basic setting menu	11-1
trigger mode	4-1	X-Y Cursor menu	11-3
trigger position	4-2	X-Y Display setting menu	11-2
trigger settings (Enhanced - AND)	4-14	XY waveform, turning the display on and off	11-1
trigger settings (Enhanced - Edge On A)	4-11		
trigger settings (Enhanced - OR)	4-12	Z	Page
trigger settings (Enhanced - Period)	4-16	Zoom Auto Scroll menu (recorder)	15-3
trigger settings (Enhanced - Pulse Width)	4-18	Zoom Auto Scroll menu (scope)	14-4
trigger settings (Enhanced - Wave Window)	4-20	Zoom Basic setting menu (recorder)	15-1
trigger settings (Simple - Edge)	4-3	Zoom Basic setting menu (scope)	14-1
trigger settings (Simple - External)	4-7	Zoom Common setting menu (scope)	14-2
trigger settings (Simple - Logic)	4-9	Zoom Detail setting menu (recorder)	15-2
trigger settings (Simple - Time)	4-5	zoom source waveform (recorder/scope)	14-2, 15-2
trigger source (analog signal)	4-3		
trigger source (logic signal)	4-9		
T < T1, T2 < T (determination mode)	4-17		
T < Time (determination mode)	4-17		
T > Time (determination mode)	4-17		
type of file to list, selecting	6-27		
U	Page		
USB communication feature	20-3		
USB keyboard	20-3		
USB printer printing	6-16		
USB storage device	6-3		
Utility File menu	6-24		
Utility Network menu (mail transmission)	19-6		
Utility Network menu (net drive)	19-5		
Utility Network menu (SNTP)	19-7		
Utility Network menu (TCP/IP)	19-3		
Utility Network menu (VXI-11)	19-8		
Utility Network menu (Web server)	19-4		
Utility Preference menu	20-5		
Utility System menu (language/USB)	20-3		
Utility System menu (LCD)	20-2		
Utility System menu (SD formatting)	6-4		
V	Page		
values, entering	v		
velocity (frequency module)	2-31		
VXI-11	19-8		
W	Page		
waveform acquisition action/SD recording (scope)	3-3		
waveform acquisition (AND trigger)	4-14		
waveform acquisition basic setting menu (scope)	3-1		
waveform acquisition basic setting screen (recorder)	3-5		
waveform acquisition detail setting menu (scope)	3-2		
waveform acquisition detail setting screen (recorder)	3-8		
waveform acquisition (Edge On A trigger)	4-11		
waveform acquisition (edge trigger)	4-3		
waveform acquisition (external trigger)	4-7		
waveform acquisition (OR trigger)	4-12		
waveform acquisition (period trigger)	4-16		
waveform acquisition (pulse width trigger)	4-18		
waveform acquisition (START/STOP)	3-10		
waveform acquisition (time trigger)	4-5, 4-9		
waveform acquisition (trigger mode)	4-1		