

---

**User's  
Manual**

**SMARTDAC+™**

**Model GX10/GX20/GP10/GP20**

**Paperless Recorder  
User's Manual**

---



## Introduction

Thank you for purchasing the SMARTDAC+ Series GX10/GX20/GP10/GP20 (hereafter referred to as the GX or GP).

This manual explains how to use the GX/GP. **Although the display of GX20 is used in this manual, GX10/GP10/GP20 can be operated similarly.**

In this manual, the GX20/GP20 standard type and large memory type are distinguished using the following notations.

- **Standard type: GX20-1/GP20-1**
- **Large memory type: GX20-2/GP20-2**

Options are expressed using optional codes (/□□).

Example: Mathematical function (/MT)

For details on the settings and operation of the PID control module and program control (/PG option), see the *Loop Control Function, Program Control Function (/PG Option) User's Manual* (IM 04L51B01-31EN), provided as an electronic manual.

For details on other options, see the relevant user's manuals.

To ensure correct use, please read this manual thoroughly before beginning operation. The following manuals are provided for the GX/GP.

### • Paper Manuals

Manual Title	Manual No.	Description
Models GX10/GX20/GP10/GP20 Paperless Recorder First Step Guide	IM 04L51B01-02EN	Explains the basic operations of the GX/GP.

### • Downloadable Electronic Manuals

You can download the latest manuals from the following website.  
[www.smartdacplus.com/manual/en/](http://www.smartdacplus.com/manual/en/)

Manual Title	Manual No.	Description
Model GX10/GX20/GP10/GP20 Paperless Recorder First Step Guide	IM 04L51B01-02EN	This is the electronic version of the paper manual.
Model GX10/GX20/GP10/GP20 Paperless Recorder User's Manual	IM 04L51B01-01EN	Describes how to use the GX/GP. The communication control commands and some of the options are excluded.
Model GX10/GX20/GP10/GP20/GM10 Paperless Recorder Communication Command User's Manual	IM 04L51B01-17EN	Describes how to use command control communication functions.
SMARTDAC+ Standard Universal Viewer User's Manual	IM 04L61B01-01EN	Describes how to use Universal Viewer, which is a software that displays GX/GP measurement data files.
SMARTDAC+ Standard Hardware Configurator User's Manual	IM 04L61B01-02EN	Describes how to use the PC software for creating setting parameter for various GX/GP functions.
Model GX10/GX20/GP10/GP20/GM10 Multi-batch Function (/BT) User's Manual	IM 04L51B01-03EN	Describes how to use the multi-batch function (/BT option).
Model GX10/GX20/GP10/GP20 Advanced Security Function (/AS) User's Manual	IM 04L51B01-05EN	Describes how to use the advanced security function (/AS option).
Model GX10/GX20/GP10/GP20 Log Scale (/LG1) User's Manual	IM 04L51B01-06EN	Describes how to use the log scale (/LG option).
Model GX10/GX20/GP10/GP20 EtherNet/IP (/E1) Communication User's Manual	IM 04L51B01-18EN	Describes how to use the communication functions through the EtherNet/IP (/E1 option).
Model GX10/GX20/GP10/GP20 WT Communication (/E2) User's Manual	IM 04L51B01-19EN	Describes how to use WT communication (/E2 option).
Model GX10/GX20/GP10/GP20/GM10 OPC-UA Server (/E3) User's Manual	IM 04L51B01-20EN	Describes how to use the OPC-UA server function (/E3 option).
Model GX10/GX20/GP10/GP20/GM10 SLMP Communication (/E4) User's Manual	IM 04L51B01-21EN	Describes how to use SLMP communication function (/E4 option).
Model GX10/GX20/GP10/GP20/GM10 Loop Control Function, Program Operation Function (/PG Option) User's manual	IM 04L51B01-31EN	Describes how to use PID control and program control (/PG option).
DXA170 DAQStudio	IM 04L41B01-62EN	Describes how to create custom displays (/CG option).

---

## Notes

- The contents of this manual are subject to change without prior notice as a result of continuing improvements to the instrument's performance and functions.
- Every effort has been made in the preparation of this manual to ensure the accuracy of its contents. However, should you have any questions or find any errors, please contact your nearest YOKOGAWA dealer.
- Copying or reproducing all or any part of the contents of this manual without the permission of YOKOGAWA is strictly prohibited.

## Trademarks

- SMARTDAC+ is registered trademarks of Yokogawa Electric Corporation.
- Microsoft and Windows are registered trademarks or trademarks of Microsoft Corporation in the United States and/or other countries.
- Pentium is a trademark of Intel Corporation in the United States and/or other countries.
- Adobe and Acrobat are registered trademarks or trademarks of Adobe Systems Incorporated.
- Kerberos is a trademark of Massachusetts Institute of Technology (MIT).
- Company and product names that appear in this manual are registered trademarks or trademarks of their respective holders.
- The company and product names used in this manual are not accompanied by the registered trademark or trademark symbols (® and ™).

## Using Open Source Software

This product uses open source software.

For details on using open source software, see *Regarding the Downloading and Installing for the Software, Manuals and Labels* (IM 04L61B01-11EN).

## QR Code

The product has a QR Code pasted for efficient plant maintenance work and asset information management.

It enables confirming the specifications of purchased products and user's manuals. For more details, please refer to the following URL.

**<https://www.yokogawa.com/qr-code>**

QR Code is a registered trademark of DENSO WAVE INCORPORATED.

## Revisions

December 2012	1st Edition	September 2018	11th Edition
February 2013	2nd Edition	March 2019	12th Edition
May 2013	3rd Edition	December 2019	13th Edition
May 2014	4th Edition	April 2020	14th Edition
December 2014	5th Edition	May 2020	15th Edition
December 2015	6th Edition		
March 2016	7th Edition		
June 2017	8th Edition		
June 2018	9th Edition		
July 2018	10th Edition		



# GX/GP Version and Functions Described in This Manual

The contents of this manual correspond to the GX/GP with release number 4 (see the STYLE S number) and style number 3 (GX10/GX20/GP10), style number 4 (GP20) (see the STYLE H number).

## GX/GP Versions and Functions

► For the procedure to check the version, see page 2-63 in section 2.3.8, “Displaying the GX/GP System Information”.

Edition	Product	Addition and Change	Refer To
1	Version 1.01	–	–
2	Version 1.02	All data display for historical trend has been added.	section 2.2.7
		A feature that displays the maximum and minimum values and the date and time of the data at the left edge of the scale image has been added.	section 2.2.7
		The password input operation on the operation lock release screen has been changed.	section 2.9.2
		An icon for changing the report data on the report screen has been added.	section 2.3.4
		USB flash memory has been added as one of the possible alarm data save destinations.	section 2.3.1
		Web application version display has been added to the system information screen and reconfiguration screen.	section 1.24.2, section 2.3.7
		German, French, Russian, Chinese, and Korean have been added to the available languages.	section 1.18.1
		A/D calibration password is no longer initialized when the GX/GP is initialized.	section 1.24.1, section 5.1.3
		Changes have been made to prevent adjustment errors during touch screen adjustment.	section 5.1.4
3	Version 1.03	Electromagnetic relay type analog input modules have been added.	section 1.2.1, section 1.6.1, section 1.7.1, section 1.7.3, section 1.7.4, section 1.8.1, section 5.1.3, section 5.1.5
		A shortcut for the Context menu has been added.	section 2.2.5, section 2.2.6, section 2.2.7, section 2.3.3,
		Icons have been added for scrolling the tab area of the menu screen.	–
		A swipe feature has been added for selecting channels.	section 1.8.2
4	Version 2.01	Support for GX20/GP20 large memory type and expandable I/O has been added.	–
		Support for new modules (current (mA) input, low withstand voltage relay, and DI/DO) has been added.	section 1.2, section 1.3, section 1.4, section 5.1.2, section 5.1.3
		New operators have been added.	section 1.5
		Burnout criteria settings have been added.	section 1.7.5
		Record confirmation action setting has been added.	section 1.8.1, section 2.1.1
		PDF electronic signature has been added.	section 1.11.1
		Event action function has been added.	section 1.14
		SSL communication function has been added.	section 1.16.2, section 1.16.3, section 1.16.9, section 1.20.5, section 1.21.5, section 1.25, section 2.4.11
		DARWIN compatible communication has been added.	section 1.16.9, section 1.26
		Communication command execution using serial bar-codes has been added.	section 1.17.1
		Individual alarm acknowledge has been added.	section 1.18.3, section 2.4.1
		Communication command execution using USB bar-codes has been added.	section 1.18.11, section 2.6.3
		Advanced security function (/AS option) has been added	section 1.19
		Custom display function (/CG option) has been added.	section 1.20.6, section 1.21.6
		DO channel and internal switch status display has been added.	section 2.3.7
		User function key has been added.	section 2.4.10, section 1.14
		Firmware update function has been added.	section 5.1.6
		Web application function has been added.	section 3.1
		EtherNet/IP communication (/E1 option) has been added.	EtherNet/IP Communication User's Manual (IM04L51B01-18EN)
		WT communication (/E2 option) has been added.	WT Communication User's Manual (IM04L51B01-19EN)
		Log scale function (/LG option) has been added.	Log Scale User's Manual (IM04L51B01-06EN)

GX/GP Version and Functions Described in This Manual

Edition	Product	Addition and Change	Refer To
5	Version 2.02	Display span zoom function has been added.	section 2.2.7
		Display span modification from the monitor has been added.	section 2.2.1
		Support for DARWIN compatible serial communication has been added.	section 1.17, section 1.26
		Pulse input function for DI channels has been added.	section 1.3.1, section 1.7.6
		Number of scale divisions for DI channels have been added (during pulse input).	section 1.3.3
6	Version 3.01	Support for pulse input modules has been added.	section 1.4
		The number of math channels has been increased (GX20-2, GP20-2: 200 channels)	section 1.6
		The number of timers and match time timers has been increased (12).	section 1.14
		A new component for custom display (/CG option) has been added.	—
		Trend screen fine grid has been added.	section 2.2.1
		Modbus registers have been added (multi batch support).	section 4.5
		Alarm level was added as a way to detect alarm notification mails.	section 1.17.4
		Settings that can be selected to be initialized have been added.	section 1.25
		Settings that can be selected to be loaded from setting files have been added.	section 1.21
		Customization function has been added for the monitor tree display on the Web application.	section 1.17.10
		Support for saving and loading all settings through the Web application has been added.	section 3.1.6
		Support has been added for communication security function of DARWIN compatible communication.	—
		Aerospace heat treatment (/AH option) has been added.	section 1.28
		Multi-batch function (/BT option) has been added.	Multi-batch Function User's Manual (IM 04L51B01-03EN)
		OPC-UA server function (/E3 option) has been added.	OPC-UA Server Function User's Manual (IM 04L51B01-20EN)
SLMP communication (/E4 option) had been added.	SLMP Communication User's Manual (IM 04L51B01-21EN)		
7	Version 3.02	Quick setting function was added.	Chapter 1 Configuring the GX/GP "What Do You Want to Configure?"
		Read feature of Modbus register (batch related) has been added	section 4.5.5
		Description of the port limitation setting of DARWIN compatible communication has been added	section 1.27.1 Communication Command User's Manual (IM 04L51B01-17EN)
8	Version 4.01	Measurement mode has been added.	Section 1.29.3
		Support for high-speed AI, 4-wire RTD/resistance modules has been added.	Section 1.2
		Support for PID control modules and program control (/PG option) has been added.	Section 1.7
		Support for analog output modules has been added.	Section 1.5
		Logic math function (/MT option) has been added.	Section 1.9
		Variable constants have been added.	Section 1.8.7
		Individual settings have been added to initialization.	Section 1.29.2
		Control event action has been added.	Loop Control Function, Program Control Function (/PG Option) User's Manual (IM 04L51B01-31EN).
		Program control (/PG option) has been added.	Section 1.31
Support for new modules with DARWIN compatible communication function has been added. Support for DR commands has been added.	Section 1.31		
9	Version 4.02	Calibration correction of communication channel has been added.	section 1.20.4 section 1.32
10	Version 4.03	Support for high withstand voltage AI module.	section 1.2
11	Version 4.04	5.2.3 Auto restart when a device error occurs has been added.	section 5.2.3
12	Version 4.06	Support for GX/GP firmware version R4.06 (Removed the use of Java in the Web application. Added Google Chrome to supported browsers).	—
13	Version 4.07	Support for GX/GP firmware version R4.07 (Added data integrity for Advanced security function(/AS option). Added EtherNet/IP communication function.).	—
14	Version 4.08	Future pen function has been added.	section 1.33, section 2.2.11, section 2.3.11
15	Same as edition 14	Changed the style (H:3 (GX10/GX20/GP10), H:4 (GP20)).	—

# How to Use This Manual

## Structure of the Manual

Read the First Step Guide (IM04L51B01-02EN) first to familiarize yourself with the basic operation of the GX/GP, and then read this manual. For a description of the communication control command functions and the accompanying software programs—Standard Hardware Configurator and Universal Viewer—read the respective manuals.

This user's manual consists of the following sections.

Chapter	Title and Description
1	<b>Configuring the GX/GP</b> Explains how to configure the GX/GP.
2	<b>Operating the GX/GP</b> Explains how to operate the GX/GP.
3	<b>Using Network Functions (Ethernet interface)</b> Explains how to use network functions.
4	<b>Using Modbus Functions (Communicating with Modbus devices)</b> Explains how to use the Modbus functions.
5	<b>Maintenance and Troubleshooting</b> Explains how to inspect and calibrate the GX/GP and describes error messages and troubleshooting.
–	<b>Appendix</b> Explains measurement data file size, the types of data that the GX/GP can generate and how to use them, the text file data format, and so on.
–	<b>General Specifications</b> Provides the specifications of the GX/GP.

### Note

- This user's manual covers information regarding GX/GPs whose display language is English (language suffix code "E").
- ► For the procedure to set the display language, see page 1-205 in section 1.23.1, "Setting the Display Language, Temperature Unit, Decimal Point Type, and Date Format".

## Module Notation

When necessary, the following notations are used to distinguish the GX90XA analog input modules by type.

Type suffix code	Notation
-U2	Universal
-C1	Current (mA)
-L1	Low withstand voltage relay
-T1	Electromagnetic relay
-H0	High-speed universal or high-speed AI
-R1	4-wire RTD/resistance
-V1	High withstand voltage

## Conventions Used in This Manual

Unit	
K	Denotes 1024. Example: 768K (file size)
k	Denotes 1000.

### Markings



**CAUTION**

**WARNING**

**CAUTION**

**Note**

*Improper handling or use can lead to injury to the user or damage to the instrument.* This symbol appears on the instrument to indicate that the user must refer to the user's manual for special instructions. The same symbol appears in the corresponding place in the user's manual to identify those instructions. In the manual, the symbol is used in conjunction with the word "WARNING" or "CAUTION."

Calls attention to actions or conditions that could cause serious or fatal injury to the user, and precautions that can be taken to prevent such occurrences.

Calls attention to actions or conditions that could cause light injury to the user or cause damage to the instrument or user's data, and precautions that can be taken to prevent such occurrences.

Calls attention to information that is important for the proper operation of the instrument.

### Reference Item



Reference to related operation or explanation is indicated after this mark.

Example: ▶ section 4.1

### Conventions Used in the Procedural Explanations

**Bold characters** Denotes key or character strings that appear on the screen.

Example: **Volt**

A|a|#|1

Indicates the character types that can be used.

A uppercase alphabet, a lowercase alphabet, # symbol,

1 numbers

**Procedure**

Carry out the procedure according to the step numbers. All procedures are written with inexperienced users in mind; depending on the operation, not all steps need to be taken.

**Explanation**

Explanation gives information such as limitations related the procedure.

**Path**

Indicates the setup screen and explains the settings.

**Description**

# Contents

Introduction.....	i
GX/GP Version and Functions Described in This Manual .....	iii
How to Use This Manual.....	v
Basic Functions of the GX/GP .....	xiii
Measurement.....	xiii
Recording .....	xiii
Display.....	xv
Saving.....	xvii
Data Utilization .....	xviii
Control.....	xviii

## Chapter 1 Configuring the GX/GP and Viewing the Settings

Setup Guide (Read this first) .....	1-1
What Do You Want to Configure? .....	1-13
Quick Setting Function (GP10/GP20, Release number 3 (Version 3.02) and later).....	1-25
1.1 Setting the Date and Time.....	1-26
1.2 Configuring AI Channels (Analog (including DI) input) channels and AI (mA) channels ...	1-27
1.2.1 Setting the Range .....	1-27
1.2.2 Setting Alarms .....	1-35
1.2.3 Setting the Display .....	1-40
1.2.4 Setting Calibration Correction (Linearizer approximation, linearizer bias, Correction Factor <sup>1</sup> (release number 3 and later)).....	1-53
1.3 Configuring DI Channels (Digital input channels) .....	1-57
1.3.1 Setting the Range .....	1-57
1.3.2 Setting Alarms .....	1-58
1.3.3 Setting the Display .....	1-60
1.4 Configuring Pulse Input Channels (Release number 3 and later).....	1-63
1.4.1 Setting the Range .....	1-63
1.4.2 Setting Alarms .....	1-65
1.4.3 Setting the Display .....	1-66
1.5 Configuring AO Channels (Analog output channels).....	1-70
1.5.1 Setting the Range .....	1-70
1.5.2 Setting the Display .....	1-74
1.6 Configuring DO Channels (Digital output channels) .....	1-76
1.6.1 Setting the Range .....	1-76
1.6.2 Setting the Display .....	1-80
1.7 Configuring Control Function and Configuring Program Control Function.....	1-82
1.8 Configuring Math Channels (/MT option) .....	1-83
1.8.1 Setting Basic Computation Operations (Error indications, operation at start, overflow handling, PSUM overflow <sup>1</sup> handling) .....	1-83
1.8.2 Setting Expressions .....	1-84
1.8.3 Writing Expressions .....	1-91
1.8.4 Setting Alarms .....	1-101
1.8.5 Setting the Display .....	1-102
1.8.6 Setting Constants to Use in Computation .....	1-105
1.8.7 Setting Variable Constants to Use in Computation .....	1-106
1.9 Configuring Logic Math (/MT option).....	1-107
1.10 Setting Display Conditions .....	1-110
1.10.1 Setting the Trend Interval .....	1-110
1.10.2 Setting Display Groups .....	1-111
1.10.3 Setting Messages.....	1-113
1.10.4 Setting Trend Display Conditions .....	1-114
1.10.5 Setting Basic Screen Items.....	1-117
1.11 Setting Measurement Conditions (Scan interval, A/D integrate, etc.) .....	1-119
1.11.1 Setting the Scan Interval.....	1-119
1.11.2 Setting the Over-range Detection Method.....	1-120
1.11.3 Setting the Operation Mode of a Module .....	1-120
1.11.4 Setting the A/D Integral Time .....	1-122

1

2

3

4

5

App

Index

1.11.5	Setting the Noise Rejection (High-speed AI, PID control module) (Release number 4 and later)	1-123
1.11.6	Setting the Burnout Criteria (Release number 2 and later)	1-124
1.11.7	Setting the Chattering Filter (DI module) for Pulse Input	1-124
1.12	Setting Recording Conditions (Recording mode, recording interval, saving interval)	1-125
1.12.1	Setting the Type of Data to Record (Display or event data) and Recording Conditions	1-125
1.12.2	Configuring Recording Channels	1-133
1.13	Configuring the Dual Interval Settings (Release number 4 and later)	1-137
1.13.1	Setting the Scan Interval	1-137
1.13.2	Setting the Scan Interval of Each Module	1-138
1.13.3	Setting the Recording Conditions	1-138
1.13.4	Configuring Recording Channels	1-140
1.14	Setting the Conditions for Saving Data Files	1-141
1.14.1	Setting the Save Directory, File Header, and File Name	1-141
1.14.2	Setting the Save Method to Media (Auto save or manual save) and Media FIFO	1-143
1.14.3	Setting the File Format of Display Data and Event Data	1-147
1.15	Configuring the Batch Function	1-148
1.15.1	Configuring the Batch Function (Lot-No. digit and Auto increment)	1-148
1.15.2	Setting Batch Text	1-148
1.15.3	Setting the Recording Start Screen (Release number 3 and later)	1-149
1.16	Configuring the Report Function (/MT option)	1-151
1.16.1	Setting the Report Type, Creation Time, Data Type, Etc.	1-151
1.16.2	Setting the Channels to Output Reports	1-154
1.17	Using the Report Template Function (/MT option)	1-156
1.17.1	Excel Report Files	1-156
1.17.2	PDF Report Files	1-157
1.17.3	Printing on a Printer over the LAN	1-157
1.17.4	Creating Template-Based Report Files	1-158
1.17.5	Loading and Saving Report Template Files	1-158
1.18	Setting the Timers	1-159
1.18.1	Setting the Timers	1-159
1.18.2	Setting the Match Time Timer	1-160
1.19	Configuring the Event Action Function	1-162
1.19.1	Setting Event Action Numbers and Actions	1-162
1.19.2	Event Action Examples	1-170
1.20	Configuring Communication Channels (/MC option)	1-173
1.20.1	Enabling Communication Channels and Setting the Span, Decimal Point, and Unit	1-173
1.20.2	Setting Alarms	1-175
1.20.3	Setting the Display	1-176
1.20.4	Setting Calibration Correction (Linearizer approximation, linearizer bias, Correction Factor <sup>1</sup> (release number 4 (version 4.02) and later))	1-179
1.21	Configuring the Ethernet Communication Function	1-182
1.21.1	Setting Basic Communication Conditions	1-182
1.21.2	Configuring the FTP Client Function	1-184
1.21.3	Configuring the SMTP Client Function	1-186
1.21.4	Setting E-mail Transmission Conditions (When the SMTP client function is on)	1-187
1.21.5	Setting the SNTP Client Function	1-190
1.21.6	Configuring the Modbus Client Function (Option, Function available when /MC is specified)	1-191
1.21.7	Configuring the Server Function	1-194
1.21.8	Limiting the Connection to the Modbus Server (GX/GP)	1-195
1.21.9	Setting the Server Functions to Use (FTP, HTTP, SNTP, MODBUS, GENE, DARWIN compatible communication)	1-196
1.21.10	Setting the Web Content Selection Tree (release number 3 and later)	1-199
1.22	Configuring the Serial Communication Function (/C2 and /C3 options)	1-200
1.22.1	Setting Basic Communication Conditions	1-200
1.22.2	Enabling or Disabling the Modbus Master Function (/MC option) and Setting Communication Conditions	1-202
1.22.3	Setting Modbus Master Transmission Commands	1-203
1.23	Configuring System Settings (Time zone, display language, status relay, etc.)	1-205
1.23.1	Setting the Display Language, Temperature Unit, Decimal Point Type, and Date Format	1-205
1.23.2	Setting the Interval for Calculating the Rate-of-Change for Rate-of-Change Alarms	1-206
1.23.3	Setting the Alarm Display Hold/Nonhold and Individual Alarm ACK Operation	1-207
1.23.4	Setting the Time Zone, Gradual Time Adjustment, and Daylight Saving Time	1-207
1.23.5	Setting Internal Switches	1-210
1.23.6	Setting the FAIL Relay and Instrument Information Output (/FL option)	1-211

1.23.7	Setting the Printer Output Conditions.....	1-213
1.23.8	Configuring the Sound (Touch sound and warning sound) and LED Settings .....	1-214
1.23.9	Setting Instrument Tags .....	1-214
1.23.10	Setting Comments to Setting Files.....	1-215
1.23.11	Setting USB Input Devices (/UH option) .....	1-216
1.24	Configuring the Security Functions .....	1-220
1.24.1	Configuring the Security Functions .....	1-220
1.24.2	Setting Items to Lock the Operation Of (When touch operation is set to operation lock)...	1-221
1.24.3	Setting Registered User Conditions (When touch operation or communication is set to login) .....	1-224
1.24.4	Setting User Restrictions (When touch operation or communication is set to login).....	1-225
1.25	Loading Settings .....	1-226
1.25.1	Loading Setting Parameters.....	1-226
1.25.2	Loading and Deleting Scale Images .....	1-228
1.25.3	Loading Report Templates (/MT option).....	1-230
1.25.4	Loading and Deleting Trusted Certificates (Release number 2 and later) .....	1-232
1.25.5	Loading and Deleting Custom Displays (/CG option) (Release number 2 and later).....	1-234
1.25.6	Loading and Deleting Program Patterns (/PG option) (Release number 4 and later), .....	1-236
1.25.7	Loading Setting Parameters, Scale Images, Report Templates, Trusted Certificates (Release number 2 and later), Custom Display (/CG option) (Release number 2 and later), Program Pattern (/PG option) (Release number 4 and later), Multi-batch Settings (/BT option) (Release number 3 and later) at Once .....	1-238
1.26	Saving Setting Parameters .....	1-240
1.26.1	Saving the Setting Parameters .....	1-240
1.26.2	Saving a Scale Image .....	1-241
1.26.3	Saving a Report Template.....	1-243
1.26.4	Saving Trusted Certificates (Release number 2 and later) .....	1-244
1.26.5	Saving Custom Displays (/CG option) (Release number 2 and later).....	1-244
1.26.6	Saving Program Patterns (/PG option) (Release number 4 and later).....	1-246
1.26.7	Saving Setting Parameters, Scale Images, Report Templates, Trusted Certificates (Release number 2 and later), Custom Display (/CG option) (Release number 2 and later), Program Pattern (/PG option) (Release number 4 and later) at Once.....	1-248
1.27	Listing Files That Are on the External Storage Medium .....	1-249
1.28	Formatting the External Storage Medium .....	1-250
1.29	Initializing and Calibrating the System (Initialization, reconfiguration, touch screen calibration), Setting the Measurement Mode .....	1-251
1.29.1	Initializing the Settings and the Internal Memory .....	1-251
1.29.2	Initializing Display Groups or Recording Channels Separately.....	1-255
1.29.3	Setting the Measurement Mode .....	1-256
1.29.4	Reconfiguring the GX/GP.....	1-258
1.29.5	Adjusting the Touch Screen .....	1-259
1.30	Configuring Key Creation, Certificate Management, and Encryption/Certificate (SSL communication, PDF electronic signature) (Release number 2 and later).....	1-260
1.30.1	Enabling the Encryption Function .....	1-260
1.30.2	Creating a Key .....	1-260
1.30.3	Configuring Certificate Management (Creating self-signed certificates, creating certificate signature requests (CSRs), installing certificates, and installing intermediate certificates).....	1-261
1.30.4	Viewing Certificate Details and Removing Certificates .....	1-264
1.30.5	Configuring the Encryption of the Server Function and Client Function, and Applying PDF Electronic Signatures .....	1-266
1.30.6	Loading, Deleting, and Saving a Trusted Certificate .....	1-266
1.30.7	Verification Confirmation of Unverified Certificates .....	1-266
1.31	Using the DARWIN Compatible Communication Function (Release number 2 and later) .....	1-267
1.31.1	Overview .....	1-267
1.31.2	Supported Commands .....	1-269
1.31.3	Configuring the DARWIN Compatible Communication Function .....	1-273
1.31.4	Configuring the GX/GP IP Address, Subnet Mask, and the Like (for Ethernet) .....	1-273
1.31.5	Configuring the GX/GP's Basic Serial Communication Conditions (for RS-232, RS-422/485) (version 2.02 and later) .....	1-273
1.32	Using the Aerospace Heat Treatment (/AH option) (Release number 3 and later) .....	1-274
1.32.1	Setting the Calibration Reminder .....	1-274
1.32.2	Notification Screen Display .....	1-275
1.32.3	Resetting the Calibration Reminder Due Date, Performing Calibration Correction.....	1-276
1.32.4	Displaying Reminders .....	1-279
1.32.5	Limitation of Function (When the advanced security function (/AS) is enabled).....	1-280

1

2

3

4

5

App

Index



1.33	Setting the Future Pen, Using the Future Alarm (Release number 4 (Version 4.08) and later)	1-281
1.33.1	Setting the Future Pen, Future Pen Channels	1-281
1.33.2	Using Future Alarm	1-284

## Chapter 2 Operating the GX/GP

2.1	Starting and Stopping Recording and Computation	2-1
2.1.1	Starting and Stopping Recording	2-1
2.1.2	Using the Batch Function	2-4
2.1.3	Applying a Record Start Trigger for Event Data	2-6
2.1.4	Starting, Stopping, and Resetting Computation	2-7
2.1.5	Clearing Computation Data Dropout Displays	2-9
2.2	Configuration of Measured Data Display	2-10
2.2.1	Displaying Measured Data Using Waveforms, Numeric Values, Bar Graph, or Custom Display (/CG option) (Trend, digital, bar graph, and custom displays)	2-10
2.2.2	Switching the Group to Display	2-19
2.2.3	Displaying the Statuses of All Channels on One Screen (Overview Display)	2-21
2.2.4	Displaying the Multi Panel (GX20/GP20 only)	2-23
2.2.5	Writing Registered Messages and Free Messages	2-24
2.2.6	Writing Freehand Messages	2-29
2.2.7	Displaying Previously Measured Data (Historical trend display)	2-31
2.2.8	Switching to the Secondary Trend Interval	2-39
2.2.9	Registering and Showing the Standard Display	2-40
2.2.10	Loading and Displaying Display Data and Event Data from the External Storage Medium	2-40
2.2.11	Displaying Future Pen (Predicted future waveforms) (Release number 4 (Version 4.08) and later)	2-41
2.3	Displaying Various Types of Information	2-43
2.3.1	Listing the Log of Alarm Occurrences and Releases (Alarm Summary)	2-43
2.3.2	Displaying the Log of Written Messages (Message summary)	2-45
2.3.3	Displaying a List of Data Files in the Internal Memory and Saving Data (Memory summary)	2-47
2.3.4	Displaying Reports	2-51
2.3.5	Displaying Logs	2-53
2.3.6	Checking the Command Status of the Modbus Client and Modbus Master	2-60
2.3.7	Displaying the DO Channel and Internal Switch Status (Release number 2 and later)	2-62
2.3.8	Displaying the GX/GP System Information	2-63
2.3.9	Displaying Network Information	2-66
2.3.10	Displaying Reminders (/AH) (Release number 3 and later)	2-66
2.3.11	Listing the Log of Future Alarm Occurrences (Future Alarm Summary) (Release number 4 (Version 4.08) and later)	2-67
2.4	Executing Various Functions	2-69
2.4.1	Releasing Alarm Output (Alarm ACK and individual alarm ACK operation)	2-69
2.4.2	Disabling and Enabling Operation (Operation lock function)	2-70
2.4.3	Resetting Timers (Relative timers)	2-70
2.4.4	Resetting Match Time Timers	2-71
2.4.5	Generating a Record Start Trigger for Event Data	2-71
2.4.6	Using, Registering, and Deleting Favorite Screens	2-71
2.4.7	Performing a Test Print	2-72
2.4.8	Clearing the Buzzer Sound	2-72
2.4.9	Adjusting the Clock Manually	2-72
2.4.10	Using the User Function Keys (Release number 2 and later)	2-72
2.4.11	Verifying Unverified Certificates (Release number 2 and later)	2-73
2.4.12	Resetting the Calibration Reminder Due Date, Performing Calibration Correction (/AH) (Release number 3 and later)	2-73
2.5	Saving Various Types of Data	2-74
2.5.1	Automatically Saving Measured Data	2-74
2.5.2	Manually Saving Measured Data (Collectively saving unsaved data)	2-74
2.5.3	Manually Saving Instantaneous Values of Measured Data (Manual sample)	2-75
2.5.4	Saving and Printing Screen Image Data (Snapshot)	2-75
2.5.5	Saving Internal Memory Files to an SD Memory Card or USB Flash Memory	2-76
2.5.6	Saving Display Data or Event Data during Recording through Touch Operation	2-76
2.5.7	Removing the SD Memory Card or USB Flash Memory	2-77
2.6	Using USB Peripheral Devices	2-78
2.6.1	Using a Keyboard or Bar Code Reader	2-78
2.6.2	Using a Mouse	2-79
2.6.3	Executing Communication Commands with a USB Bar code Reader (Release number 2 and later)	2-80



2.7	Performing Network Related Operations .....	2-81
2.7.1	Performing an Mail Transmission Test .....	2-81
2.7.2	Starting and Stopping Mail Transmission .....	2-81
2.7.3	Checking FTP File Transfers (FTP transmission test).....	2-82
2.7.4	Adjusting the Clock Manually (SNTP time adjustment).....	2-82
2.7.5	Outputting Snapshots or Report Data to a Network Printer .....	2-83
2.7.6	Displaying Network Connection Information .....	2-83
2.7.7	Obtaining and Releasing Network Information Received through DHCP .....	2-83
2.8	Performing File Operations .....	2-85
2.8.1	Initializing the Internal Memory .....	2-85
2.8.2	Loading and Displaying the Measured Data (Display data and event data) from the Storage Medium .....	2-85
2.8.3	Formatting the External Storage Medium .....	2-86
2.9	Disabling Operation (Operation lock function) .....	2-87
2.9.1	Locking the Operation .....	2-87
2.9.2	Releasing the Operation Lock .....	2-87
2.10	Allowing Only Registered Users to Operate.....	2-88
2.10.1	Logging In and Logging Out.....	2-88
2.10.2	Changing the Password .....	2-89

## Chapter 3 Using Network Functions (Ethernet interface)

3.1	Using the Web Application to Change the GX/GP Settings, Monitor Data, and Control the GX/GP (Web server function).....	3-1
3.1.1	Connecting to a Network.....	3-1
3.1.2	Starting and Closing the Main Application.....	3-2
3.1.3	Controlling the GX/GP.....	3-10
3.1.4	Monitoring the GX/GP Data and Controlling the GX/GP from the Monitor Screen .....	3-16
3.1.5	Changing Settings .....	3-42
3.1.6	Saving and Loading Settings and Saving and Loading Various Files .....	3-55
3.1.7	Changing the Display Settings on the Browser.....	3-60
3.1.8	Changing the Password .....	3-61
3.2	Transmitting E-mail Messages .....	3-62
3.2.1	Configuring the SMTP Client Function .....	3-62
3.2.2	Setting the Mail Content.....	3-62
3.2.3	Performing an Mail Transmission Test .....	3-63
3.2.4	Starting and Stopping E-mail Transmission .....	3-63
3.2.5	E-mail Format.....	3-64
3.3	Accessing the Measurement Data File on the GX/GP from a PC (FTP server function) ..	3-72
3.3.1	Configuring FTP Server Settings .....	3-72
3.3.2	Accessing the GX/GP from a PC .....	3-72
3.4	Transferring Data Files from the GX/GP (FTP client function) .....	3-74
3.4.1	Configuring the FTP Client Function .....	3-74
3.4.2	Testing the FTP Transfer .....	3-76
3.5	Synchronizing the Time (SNTP client function).....	3-77
3.5.1	Configuring the SNTP Client Function .....	3-77
3.5.2	Adjusting the Clock Manually .....	3-77
3.6	Transmitting Time Information from the GX/GP to SNTP Client Devices (SNTP server function) .....	3-78
3.6.1	Configuring the SNTP Server Function .....	3-78

## Chapter 4 Using Modbus Functions (Communicating with Modbus devices)

4.1	Using Modbus/TCP to Enable Other Devices to Read Data from and Write Data to the GX/GP (Modbus server function) .....	4-1
4.1.1	Setting Basic Network Communication Conditions .....	4-1
4.1.2	Configuring the Modbus Server Function.....	4-1
4.1.3	Reading from and Writing to the GX/GP from Other Devices .....	4-2
4.2	Using Modbus/TCP to Enable the GX/GP to Read Data from and Write Data to Other Devices (Modbus client function) .....	4-3
4.2.1	Setting Basic Network Communication Conditions .....	4-3
4.2.2	Configuring the Modbus Client Function .....	4-3
4.2.3	Configuring the destination server .....	4-4
4.2.4	Setting Commands.....	4-4
4.2.5	Checking the Modbus Operation Status .....	4-7

4.3	Using Modbus to Enable Other Devices to Read Data from and Write Data to the GX/GP (Modbus slave function) .....	4-8
4.3.1	Setting Serial Communication Conditions .....	4-8
4.3.2	Reading from and Writing to the GX/GP from Other Devices .....	4-8
4.4	Using Modbus to Enable the GX/GP to Read Data from and Write Data to Other Devices (Modbus master function) .....	4-9
4.4.1	Setting Serial Communication Conditions .....	4-9
4.4.2	Configuring the Modbus Master Function .....	4-9
4.4.3	Setting Commands .....	4-9
4.4.4	Checking the Modbus Operation Status .....	4-10
4.5	Modbus Function and Register Assignments .....	4-11
4.5.1	Modbus Client/Master Function .....	4-11
4.5.2	Modbus Server/Slave Function .....	4-13
4.5.3	Register Assignments (Shared with the Modbus server/slave function) .....	4-13
4.5.4	Input Registers (Shared with the Modbus server/slave function) .....	4-16
4.5.5	Hold Registers (Shared with the Modbus server/slave function) .....	4-37
4.5.6	Coil .....	4-63
4.5.7	Input Relay .....	4-64
4.5.8	Property area .....	4-66

## Chapter 5 Maintenance and Troubleshooting

5.1	Maintenance .....	5-1
5.1.1	Periodic Inspection .....	5-1
5.1.2	Calibrating AI Modules .....	5-1
5.1.3	Performing A/D Calibration and Adjusting the Input Accuracy of AI Modules .....	5-6
5.1.4	Calibrating the D/A of AO Modules and Adjusting the Output Accuracy .....	5-11
5.1.5	Calibrating the I/O of PID Modules and Adjusting the I/O Accuracy .....	5-13
5.1.6	Adjusting and Checking the Touch Screen .....	5-18
5.1.7	Recommended Replacement Periods for Worn Parts .....	5-19
5.1.8	Updating the Firmware (Release number 2 and later) .....	5-21
5.2	Troubleshooting .....	5-24
5.2.1	Messages .....	5-24
5.2.2	Troubleshooting .....	5-42
5.2.3	Auto restart when a device error occurs (release number 4 (version R4.04) and later) .....	5-45

## Appendix

Appendix 1	File Size of Display Data and Event Data .....	App-1
Appendix 2	Types of Data Files That the GX/GP Can Create and How They Can Be Used .....	App-4
Appendix 3	Text File Data Format .....	App-5
Appendix 4	Creating Report Templates .....	App-17
Appendix 5	Power Recovery Operation .....	App-24
Appendix 6	Creating Scale Images .....	App-26
Appendix 7	Computation Examples Using Pulse Input .....	App-29
Appendix 8	Terminology .....	App-31

## Index

### General Specifications

GX10/GX20 General Specifications
GP10/GP20 General Specifications
GX60 Expandable I/O/GX90EX Expansion Module General Specifications
GX90XA/GX90XD/GX90YD/GX90WD/GX90XP/GX90YA I/O Module General Specifications
GX90UT PID Control Module General Specifications

# Basic Functions of the GX/GP

The basic functions of the GX/GP includes measurement, recording, display, storage, and data utilization.

In addition, loop control and program control (/PG option) become possible by installing the PID control module.

This section provides an overview of each function.

## Measurement

The GX/GP can measure signals from thermocouples, RTD sensor input, DC voltage, On/Off (voltage-free contact, level), DC current (mA), pulse input and resistance. (The input type varies depending on the module type.)

The GX/GP samples the signals received through the input modules at a specified **scan interval** and performs A/D conversion. These values become the measured values of each channel.

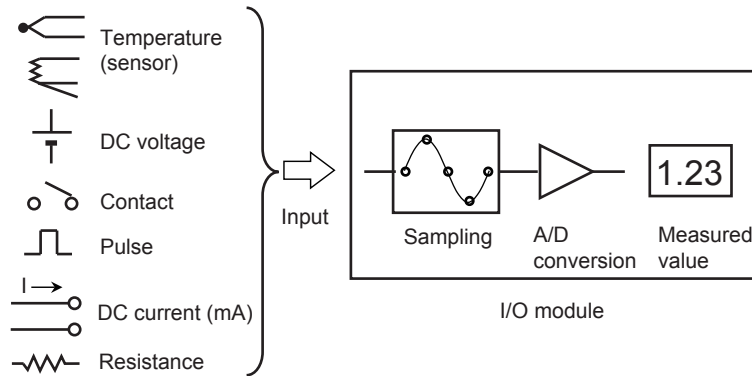

### Related Setup Items

Item	Reference
Scan interval	→page 1-119

## Recording

### Data Type

The GX/GP can record two types of measured data: **display data** and **event data** (event only when the measurement mode is set to High speed or Dual interval).

Data sampled at the scan interval is recorded in the internal memory as measured data for each specified **data type** (display data and event data).

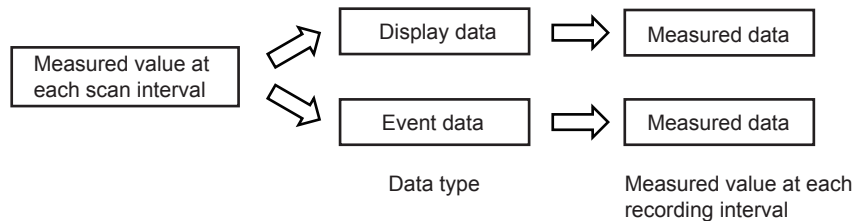

### Dual interval

When the measurement mode is Dual interval, measured data of the channels assigned to measurement groups are recorded in the internal memory by each measurement group.

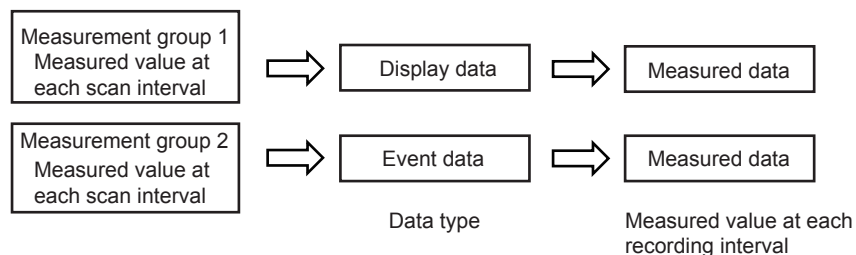

### Display Data

Display data can be likened to recording to chart paper on conventional pen recorders. Using the data sampled at the scan interval, the GX/GP records the maximum and minimum sampling data values within each recording interval (interval determined by the **trend interval [div]**). Detailed data of each sample is not retained, but because the maximum and minimum data values are recorded, display data expresses the fluctuation range in each recording interval. In addition, because the number of data values can be reduced, display data allows long-term data recording to the internal memory.

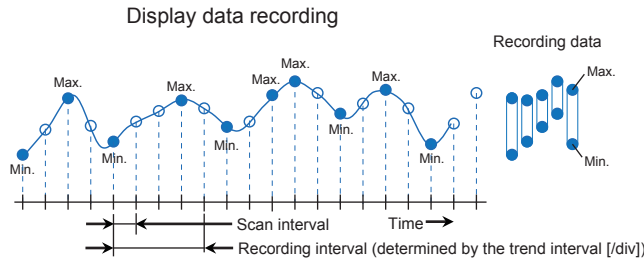

The measured data of display data is divided at the interval specified by the **saving interval** and saved to files.

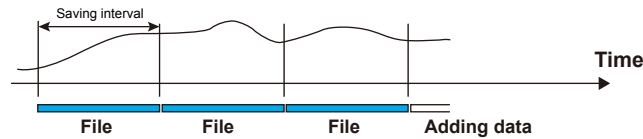

### Event Data

In the case of event data, the GX/GP records the data sampled at the scan interval at the specified **recording interval**. Event data can be likened to the data acquired using data loggers and the like where data is sampled at the scan interval (or recording interval). Detailed data is recorded, but the data size becomes large.

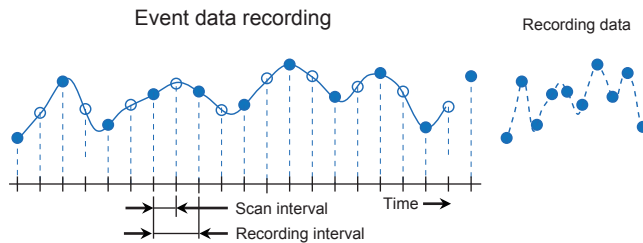

The measured data of event data is divided at the interval determined by the **data length** and saved to files.

Event data can be recorded using the following **recording modes**.

- Free: Records data at all times
- Single: Records data when the trigger condition is met
- Repeat: Records data every time the trigger condition is met

### Related Setup Items

Item	Reference
File type	→page 1-125
Saving interval	
Trend interval [div] (display data)	→page 1-110
Recording interval (event data)	→page 1-125
Data length	
Recording mode	

## Display

Measured data acquired in the internal memory can be displayed on the screen as trend waveforms, numeric values, bar graphs, and the like. In addition, in accordance with the application or the situation at the actual site, measured data can be displayed on a custom display (/CG option) that the user designs using DXA170 DAQStudio.

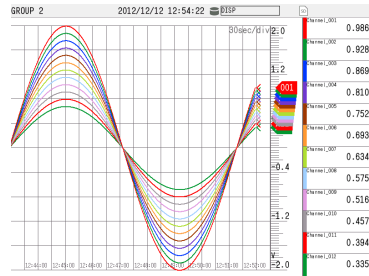

Trend

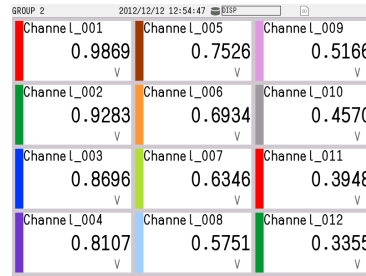

Digital

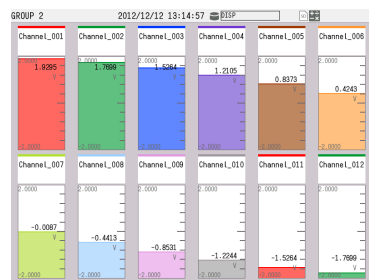

Bar graph

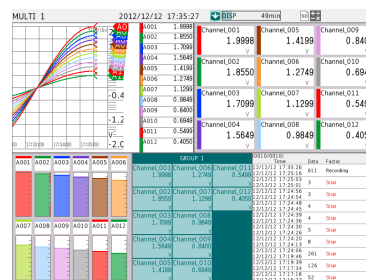

Multi panel

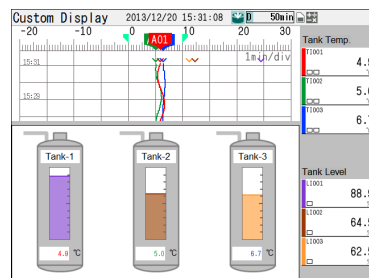

Custom display

### Trend Display of Display Data

The GX/GP shows display data according to the specified trend interval [/div]. The trend interval is specified as the time span per division of the screen. For example, if the screen shows 19 divisions, setting the trend interval to 1 min/div will cause the screen to display 19 minutes of data.

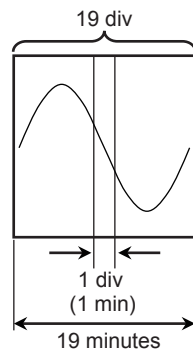

### Trend Display of Event Data

The GX/GP shows event data according to the trend interval [ /div ] that is determined by the recording interval setting.

The relationship between the recording interval and trend interval [ /div ] is shown below.

#### Recording Interval and Trend Interval

Recording interval	1ms	2ms	5ms	10ms	20ms	50ms					
Trend interval [ /div ]	100ms	200ms	500ms	1s	2s	3s					
Recording interval	100ms	200ms	500ms	1s	2s	5s	10s	15s	20s		
Trend interval [ /div ]	5s	10s	15s	30s	1min	150s	5min	450s	10min		
Recording interval	1min	2min	5min	10min	15min	20min	30min				
Trend interval [ /div ]	30min	1h	150min	5h	450min	10h	15h				

When trend interval switching is set to On, you can change between the trend intervals that are determined by the recording interval setting.

► Refer to page 1-110 in section 1.10.1, "Setting the Trend Interval"

#### Trend Interval and the Speed of Movement of Waveforms

The trend interval is analogous to the paper feeding speed of pen recorders and the like. The relationship between the trend interval and the speed of movement of waveforms is shown below.

##### GX20/GP20

Recording Interval (Trend interval)	100ms <sup>2</sup>	200ms <sup>2</sup>	500ms <sup>2</sup>	1s <sup>2</sup>	2s <sup>2</sup>	3s <sup>3</sup>
Time corresponding to one dot (ms)	1	2	5	10	20	50
Speed of waveform movement (approximation in mm/h)	1107000	553500	221400	110700	55350	22140

Recording Interval (Trend interval)	5s <sup>1</sup>	10s <sup>1</sup>	15s	30s	1min
Time corresponding to one dot (s)	0.1	0.2	0.5	1	2
Speed of waveform movement (approximation in mm/h)	11070	5535	2214	1107	554

Recording Interval (Trend interval)	2min	5min	10min	15min	20min
Time corresponding to one dot (s)	4	10	20	30	40
Speed of waveform movement (approximation in mm/h)	277	111	55	37	28

Recording Interval (Trend interval)	30min	1h	2h	4h	10h
Time corresponding to one dot (s)	60	120	240	480	1200
Speed of waveform movement (approximation in mm/h)	18	9.2	4.6	2.3	0.9

- 1 50 dots per division
- 2 100 dots per division
- 3 60 dots per division

## GX10/GP10

Recording Interval (Trend interval)	100ms <sup>2</sup>	200ms <sup>2</sup>	500ms <sup>2</sup>	1s <sup>2</sup>	2s <sup>2</sup>	3s <sup>3</sup>
Time corresponding to one dot (ms)	1	2	5	10	20	50
Speed of waveform movement (approximation in mm/h)	653400	326700	130680	65340	32670	13068

Recording Interval (Trend interval)	5s <sup>1</sup>	10s <sup>1</sup>	15s	30s	1min
Time corresponding to one dot (s)	0.1	0.2	0.5	1	2
Speed of waveform movement (approximation in mm/h)	6534	3267	1307	653	327

Recording Interval (Trend interval)	2min	5min	10min	15min	20min
Time corresponding to one dot (s)	4	10	20	30	40
Speed of waveform movement (approximation in mm/h)	163	65	33	22	16

Recording Interval (Trend interval)	30min	1h	2h	4h	10h
Time corresponding to one dot (s)	60	120	240	480	1200
Speed of waveform movement (approximation in mm/h)	11	5.4	2.7	1.4	0.5

- 1 50 dots per division
- 2 100 dots per division
- 3 60 dots per division

## Related Setup Items

Item	Reference
Trend interval [f/div] (display data)	→page 1-110
Recording interval (event data)	→page 1-125

## Saving

Data files that are divided at a specific time interval (saving interval) and held in the internal memory are automatically saved to an SD memory card (when auto save is set to On). Data files can also be exported to USB flash memory.

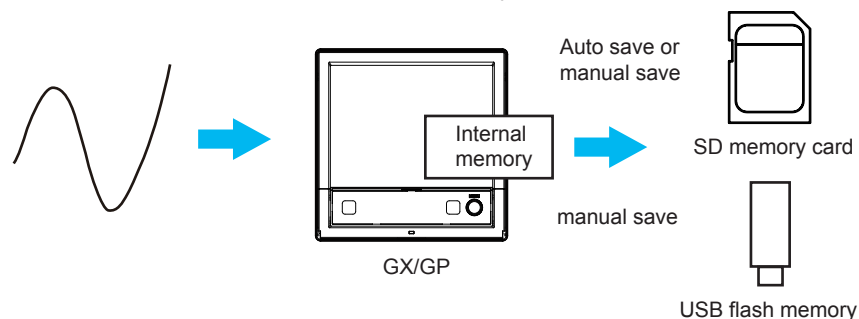

## Media FIFO Function

If not enough free space is available when saving a new data file to the SD memory card, files are deleted in order from the oldest data update date/time to save the new file. This operation is referred to as FIFO (first in first out).

When saving the data files automatically, you can save the data so that the most recent data files are constantly retained in the SD memory card. This method allows you to use the GX/GP continuously without having to replace the SD memory card.

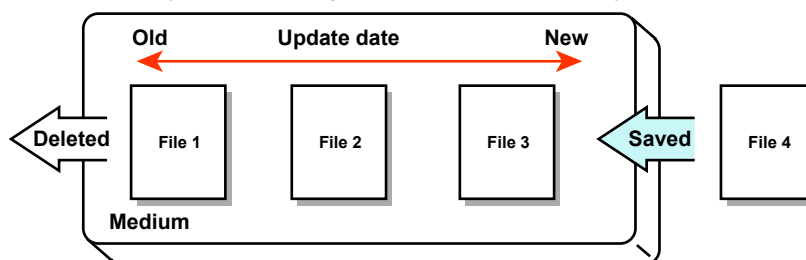

### Related Setup Items

Item	Reference
Saving interval	→page 1-125
Auto save	→page 1-143
Media FIFO	

## Data Utilization

Measurement data files can be loaded into the standard software (Universal Viewer) to display trend waveforms and values.

Moreover, data values at the cursor position can be read, statistics (maximum, minimum, P-P, average, rms) can be calculated, and so forth.

The loaded data can be converted into Excel or text format to be analyzed with other software applications or used in other ways.

## Control

By installing a PID Control Module (GX90UT), you can perform PID control of up to 20 loops (up to 6 loops for the GX10/GX20-1/GP10/GP20-1). In addition to control loop monitoring and the control group screen for convenient operation, adjustment using the tuning screen is available.

Adding the /PG option to the GX/GP main unit allows 99 patterns (up to 99 segments per pattern) of program patterns to be stored in the main unit. Further, up to 32 time events and 32 PV events can be set for each segment.



# Setup Guide (Read this first)

## GX/GP Setup Procedure

To use the GX/GP, follow the procedure below to configure it.

### Configuration flowchart

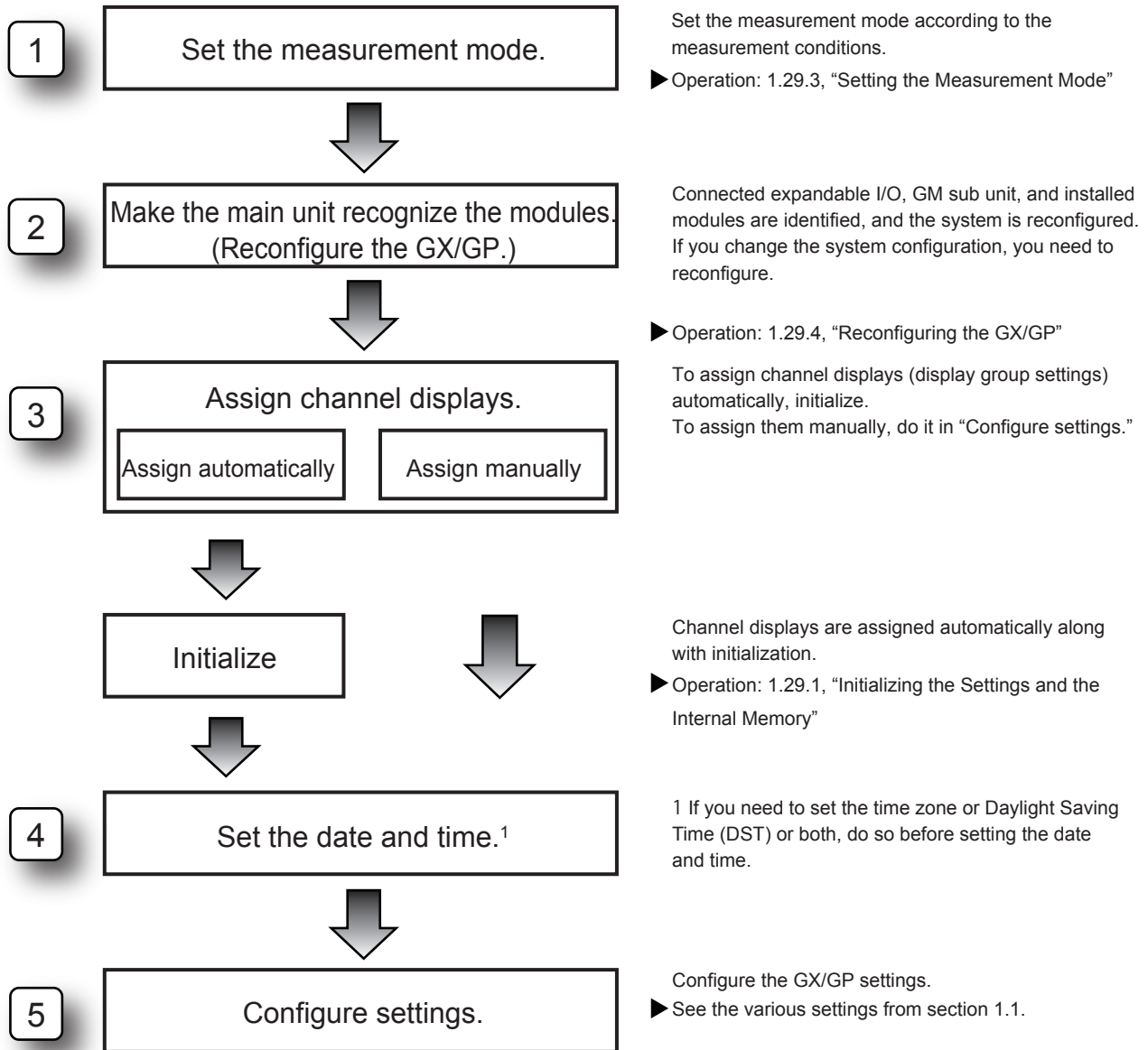

## Menu Screen

The diagram shows a 'MENU key' (a blue circular button) with an arrow pointing to the 'Menu screen'. The screen is divided into several sections:

- Top Bar:** Contains icons for Home, Eject, Recording, Computing, and Alarm Status.
- Context Tab:** Shows a graph of data for 'GROUP 1'.
- Universal Tab:** A grid of icons for various functions like Trend, Bright, Bar, Overview, Message summary, Memory summary, Internal, Set, Relay Status, Log, Multi-panel, Custom groups, Setting, Save load, Network information, and System information.
- Browse Tab:** Shows a list of items with numerical values.

Callouts from the top bar:

- Shows the standard (home) screen. A screen of your choice can be assigned to the standard screen.
- Ejects storage media (SD, USB).
- Starts and stops recording.
- Starts, stops, and resets computation.
- Shows the alarm status. You can acknowledge alarms.

**Menu screen**

**Browse tab**  
A screen for selecting what items are to be shown. Select the items to be shown such as the setting menu, measurement data, and various types of information.

**Common menu tab**  
Shows items that can be controlled globally independent of the currently displayed.

**Context tab**  
Shows the items that can be displayed and controlled on the currently displayed screen. The items vary depending on the displayed screen.

## Setting Screen

### Displaying the Setting Screen

- 1 Press **MENU**.  
The menu screen appears.
- 2 Tap the **Browse** tab.
- 3 Tap **Setting**.  
The Setting screen appears.

#### 1 MENU key



Menu screen

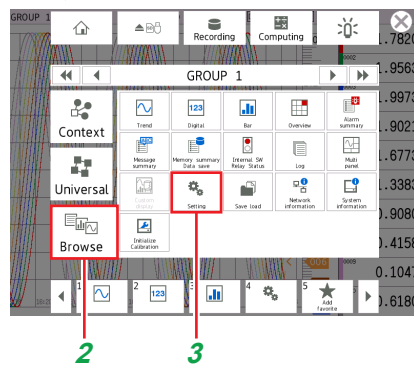

Setting screen

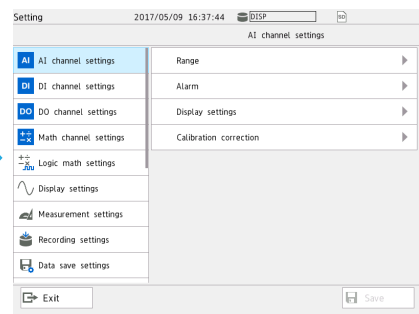

### Basic Setting Screen Operations

When you tap an item on the setting menu shown on the left side of the screen, the corresponding setup items appear in the area on the right. When a setup item is layered, tapping the setup item shows the lower layer.

Setting screen

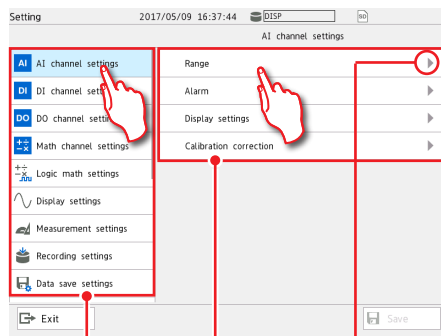

#### Setting menu

A setting menu appears.

#### Setup item

Shows the setup items for the item selected on the setting menu. When a setup item is layered, group items are displayed.

Indicates that there is a lower level.

Returns to the higher level.

Shows the item name of the current level

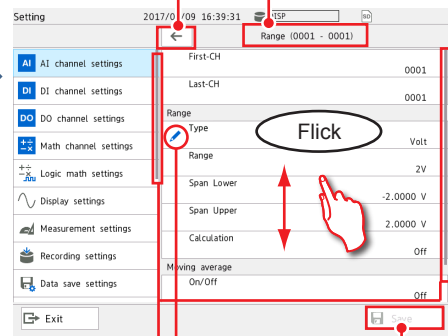

#### Change mark

Saves the settings  
Appears on items whose settings have been changed.

#### Scroll bar display

This appears when there are additional setting menus or setup items outside the screen display. Flick to show the setting menus and setup items that are hidden from the screen.

### Types of Settings

There are settings that you choose from a list or those that you enter values or character strings.

For those that you choose from a list, choose a value from the list.

For those that you need to enter a value, set the value using the displayed keyboard.

Then, tap **Save** to save the setting.

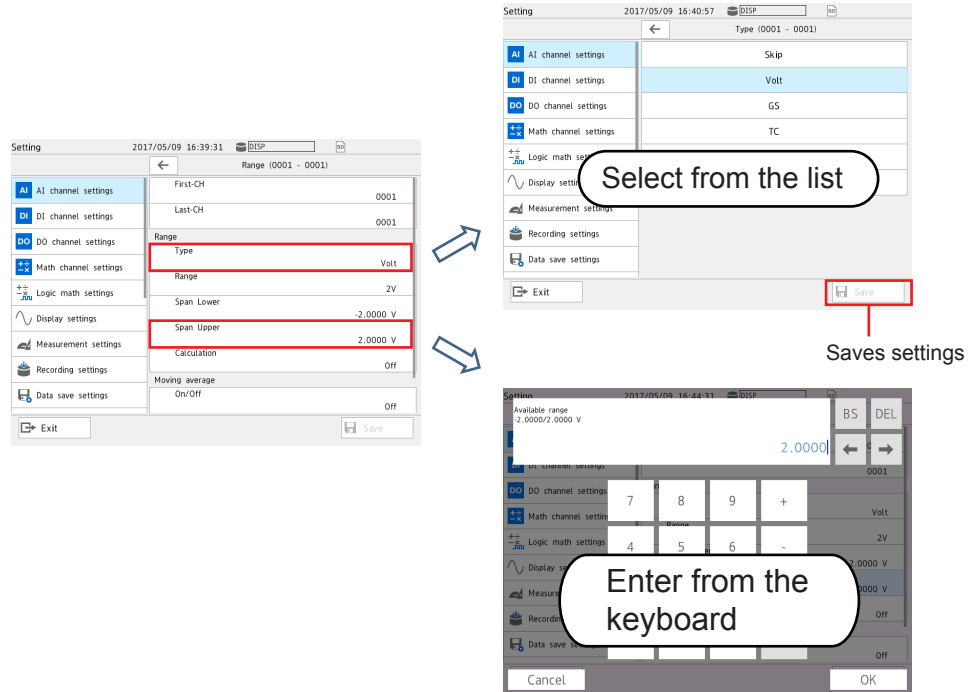

## Basic GX/GP Configuration

### Setup Procedure

This section explains the basic GX/GP setup items when the measurement mode is set to Normal.

In an actual setup, settings other than those shown here need to be configured depending on the usage conditions.

In addition, settings and values vary depending on the measurement mode.

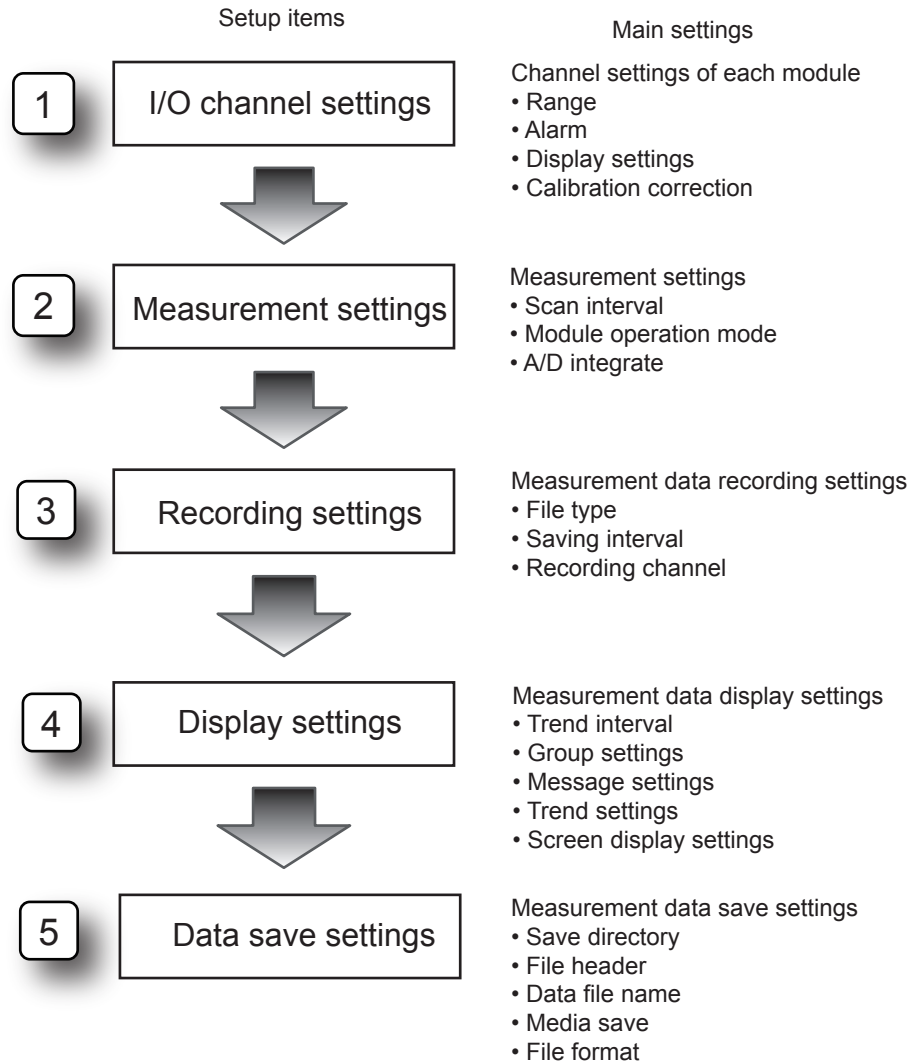

## Basic Setup

### 1. I/O Channel Settings (AI channel setting example)

The procedure for setting the range, display span (display range), alarm, tag display, and the like of each channel is described below.

#### Range Setting

##### Procedure

On the setting menu, tap **AI channel settings** and then **Range**.

##### Description

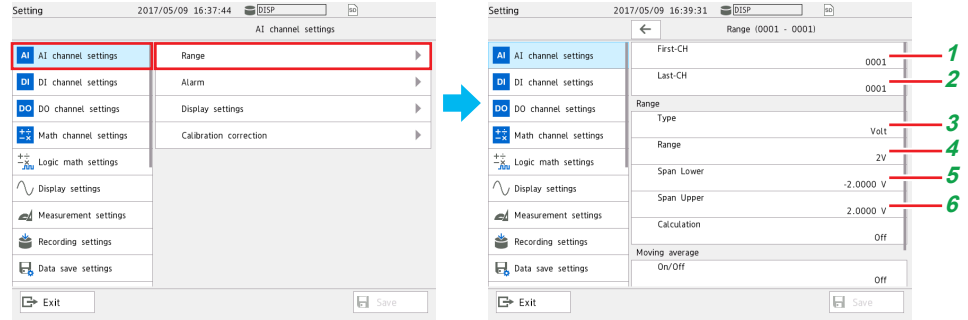

- 1 Set the first channel.<sup>1</sup>
- 2 Set the last channel.<sup>1</sup>
- 3 Set the input type.
- 4 Set the range.
- 5 Set the low limit (span lower) to be displayed.
- 6 Set the high limit (span upper) to be displayed.

1 If the settings are the same for multiple channels, you can set a channel range by specifying the first channel and last channel, and configure those channels simultaneously.

#### Alarm Setting (Example of setting level 1)

##### Procedure

On the setting menu, tap **AI channel settings** and then **Alarm**.

##### Description

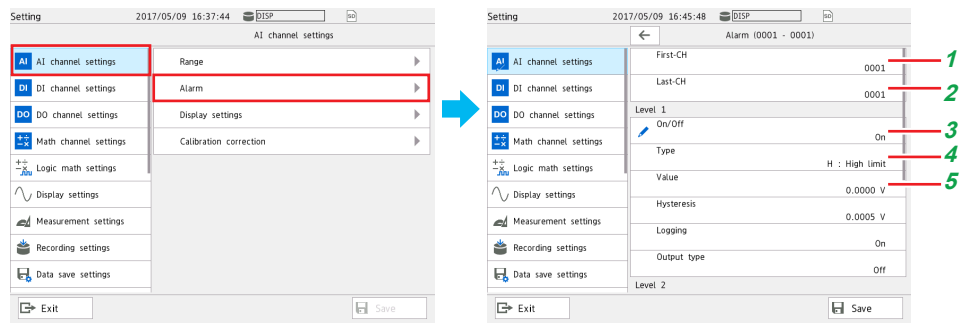

- 1 Set the first channel.
- 2 Set the last channel.
- 3 Specify **On** to assign an alarm to Level 1.<sup>1</sup>
- 4 Set the alarm type.
- 5 Set the alarm value.

1 You can set up to four alarms (Level 1 to 4).

## Display Settings

### Procedure

On the setting menu, tap **AI channel settings** and then **Display settings**.

### Description

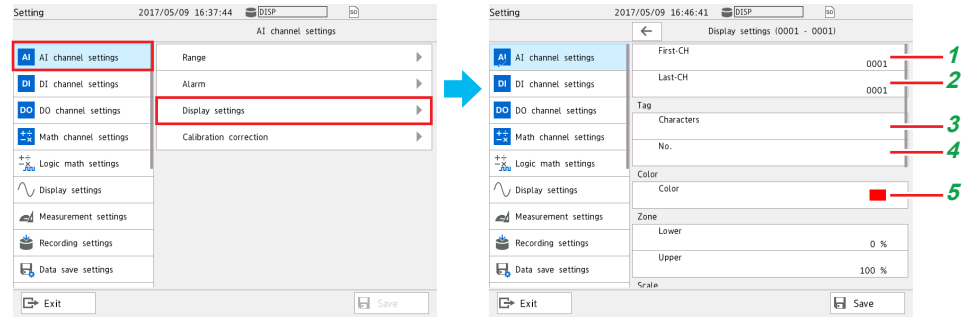

- 1 Set the first channel.
- 2 Set the last channel.
- 3 Set the tag characters.
- 4 Set the tag number.
- 5 Set the display color.

Numbers are displayed with higher precedence than characters. When a number is not assigned, the tag characters are displayed. If neither is set, the channel number is displayed.

## 2. Measurement Settings

Set the scan interval.

### Procedure

On the setting menu, tap **Measurement settings** and then **Scan interval**.

### Description

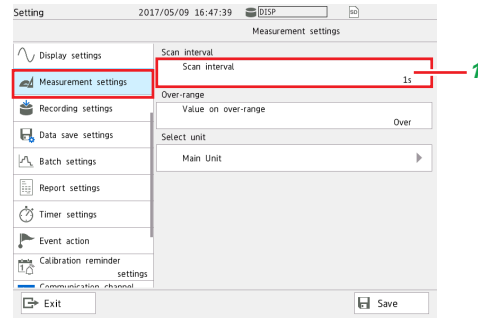

- 1 Set the scan interval.

## 3. Recording Settings

Specify the settings for recording measured data.

Set the recording conditions for each file type, display data and event data.

### Basic Setup

### Procedure

On the setting menu, tap **Recording settings** and then **Basic settings**.

### Description

#### When the File Type Is Display Data

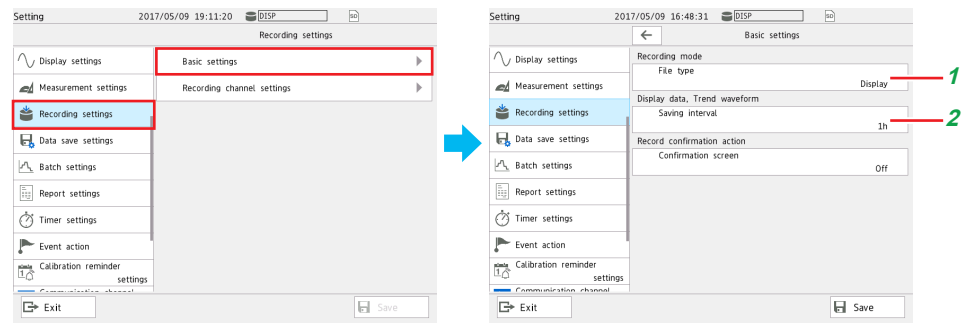

- 1 Tap **File type** and then **Display**.
- 2 Set the interval for saving data files of display data. The files are divided with the interval specified here.



### When the File Type Is Event Data

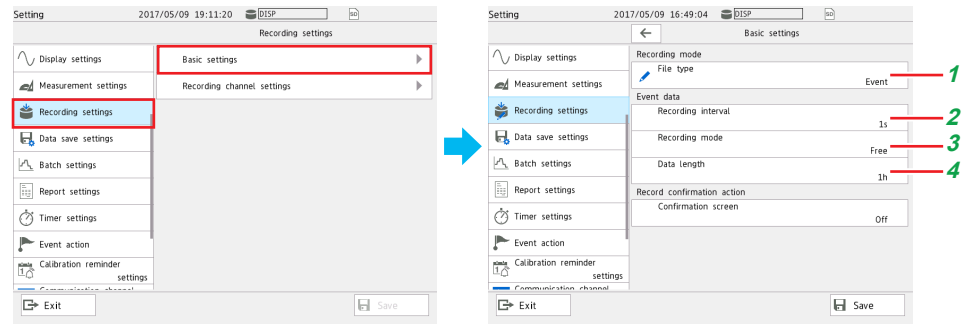

- 1 Tap **File type** and then **Event**.
- 2 Set the interval for recording event data.
- 3 Set the mode for recording event data.
- 4 Set the measurement data length (per file).

### Recording Channel Settings

#### Procedure

On the setting menu, tap **Recording settings** and then **Recording channel settings**.

#### Description

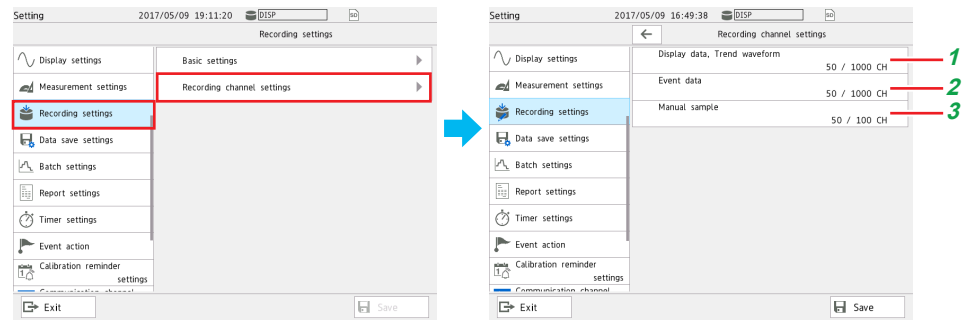

- 1 Set the channels for recording display data.
- 2 Set the channels for recording event data.
- 3 Set the channels for recording manual sampled data.

## 4. Display Settings

Specify the measured waveform display settings.

### Trend Interval Setting

#### Procedure

On the setting menu, tap **Display settings** and then **Trend interval**.

#### Description

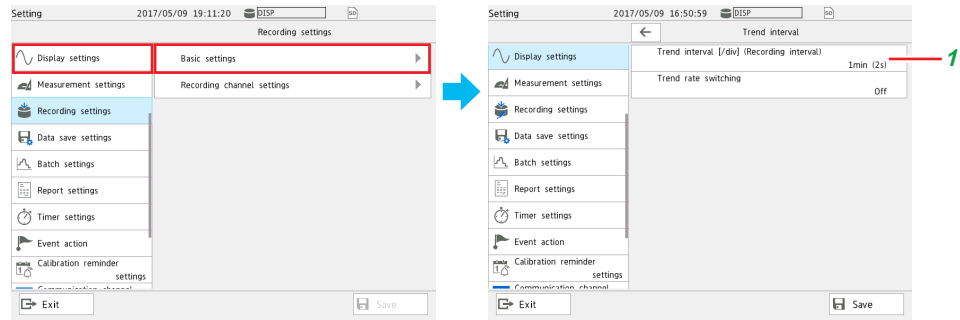

- 1 Set the trend interval [div].

### Group Settings

#### Procedure

On the setting menu, tap **Display settings** and then **Group settings**.

#### Description

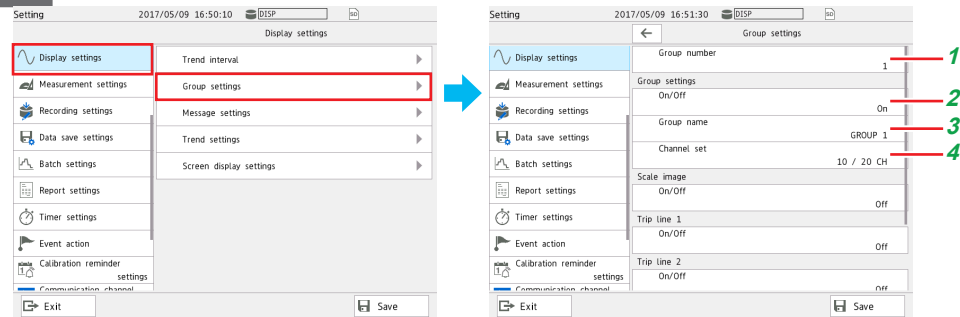

- 1 Set the number of the group to display.
- 2 Set this to **On** to use the display group of the specified display group number.
- 3 Assign a group name to the display group.
- 4 Set the channels to display in the display group.

## Message Settings (registering messages)

### Procedure

On the setting menu, tap **Display settings** and then **Trend settings**.

### Description

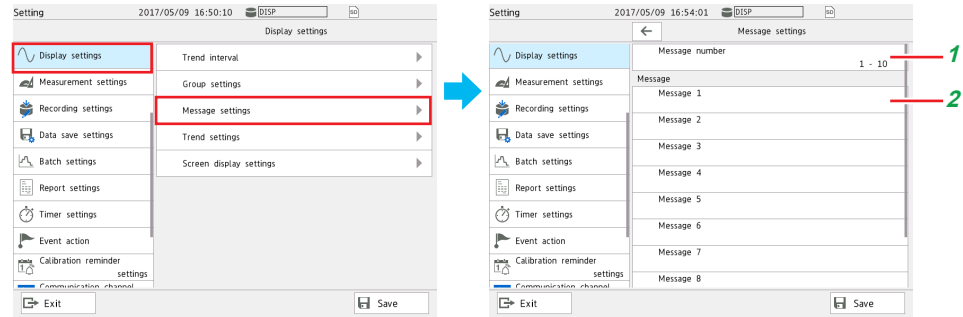

- 1 Set the message number range (in unit of 10 messages) to set (register) messages.
- 2 Assign a message to each message number.

## Trend settings

### Procedure

On the setting menu, tap **Display settings** and then **Trend settings**.

### Description

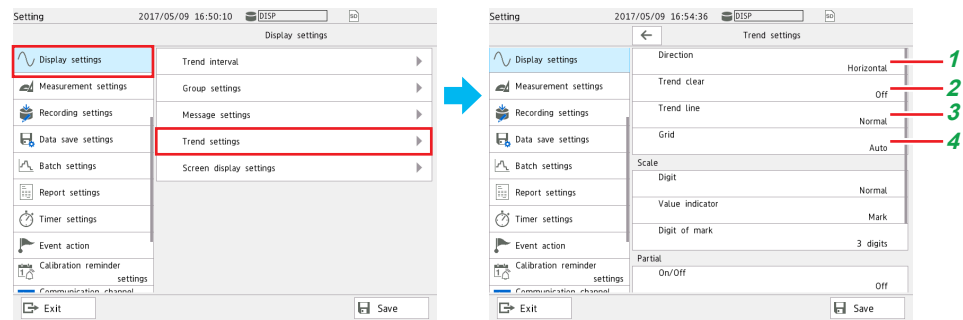

- 1 Set the direction to display waveforms (direction in which the waveforms flow).
- 2 Set this to **On** to display new waveforms after clearing the previous waveforms when recording is started.
- 3 Set the line width of displayed waveforms to Thick, Normal, or Thin.
- 4 Set the number of grids (4 to 12).

## Screen Display Settings

### Procedure

On the setting menu, tap **Display settings** and then **Screen display settings**.

### Description

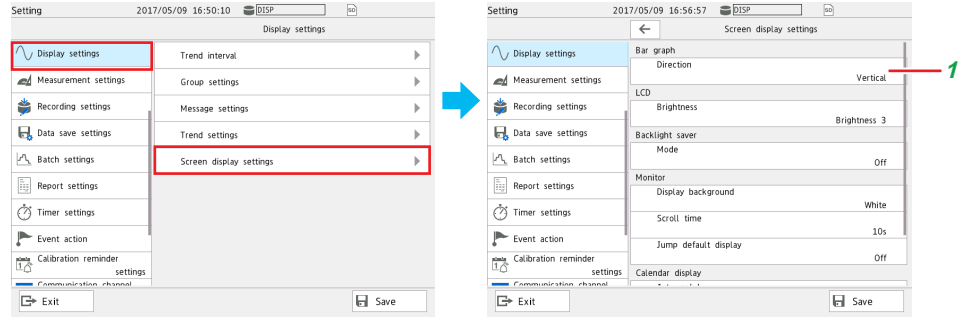

- 1 Set the bar graph display direction.

## 5. Data Save Settings

Specify the settings for saving measurement data to files.

### Procedure

On the setting menu, tap **Data save settings**.

### Description

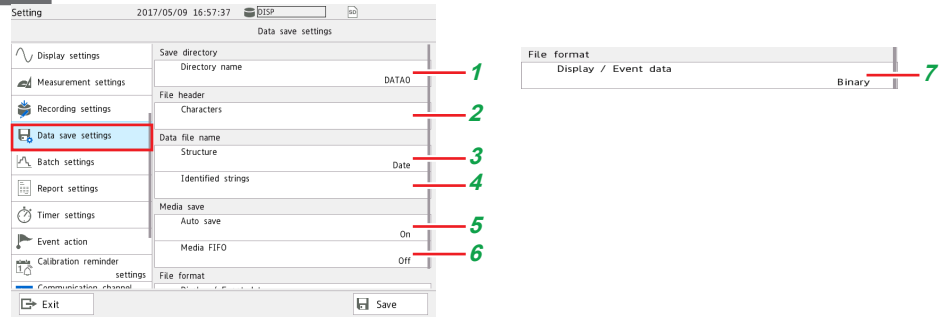

- 1 Set the directory to save data files.
- 2 Set the data file header.
- 3 Set the structure of data file names.
- 4 Set the name of the data files.
- 5 Set whether to save automatically or manually to the external storage medium. Auto saving is recommended. To use manual saving, set this to **Off**.
- 6 Set the media FIFO.  
If set to **On**, if new files cannot be saved to the external storage medium, files will be overwritten from the oldest file. If you do not want the files to be overwritten, select **Off**.  
▶ For details on media FIFO, see page 1-143 in section 1.14.2, “Setting the Save Method to Media (Auto save or manual save) and Media FIFO”.
- 7 Set the format of the files to be saved to the external storage medium.

# What Do You Want to Configure?

## 1. Measurement Source

You can assign DC voltages, thermocouples, RTDs, and on/off signals based on contacts and voltages to channels to take measurements. The measurement section is modular, so it can be expanded as necessary.

Input signals are sampled at the scan interval and converted to measured values through A/D conversion.

### Setting Measurement Conditions (Setting menu: Measurement settings, Dual interval settings)

Item	Reference
Setting the scan interval	→page 1-119
Setting the operation mode of a module (AI module: 2ch mode/10ch mode (universal, current (mA)), 2ch mode/6ch mode (4-wire RTD/resistance), DI module: normal/remote)	→page 1-120
Setting the A/D integration time of an AI module (analog input module)	→page 1-122
Setting noise rejection (high-speed AI module and PID control module)	→page 1-123
Setting how to detect over-range values	→page 1-120
Setting the burnout criteria	→page 1-124
When the measurement mode is set to dual interval (Dual interval settings)	
Item	Reference
Setting the scan interval (measurement group 1, measurement group 2)	→page 1-137
Setting the module scan intervals	→page 1-138

## 2. Configuring Measurement Channels

You can set measurement conditions for each channel based on the input. You can calculate the difference between two input values or convert input values to measurement values with units that suit your purpose.

Alarms can be generated when measured data exceeds or goes below specified values.

Information that indicates alarm occurrence can be shown on the screen. Digital output channels (DO channels) can be used to transmit relay contact signals.

You can change channel colors and assign tags to channels.

### Configuring Analog Input Channels (Setting menu: AI channel settings, AI (mA) channel)

Source module: Analog input module (GX90XA)

#### Setting the Range

Item	Reference
Input range (type, range, span lower, span upper)	
Performing input calculation (delta, linear scaling, square root)	
Taking the moving average of input values (suppressing noise)	→page 1-27
Setting the reference junction compensation mode (internal, external)	
Setting burnout detection	
Adding bias to input values	
Setting the first-order lag filter (high-speed AI module)	→page 1-32

#### Setting Alarms

Item	Reference
Setting alarms (type, value, hysteresis, logging, output, alarm delay)	→page 1-35

## What Do You Want to Configure?

---

### Setting the Display

Item	Reference
Setting channel tags (characters, No.)	
Setting display colors	
Dividing display areas to prevent waveform overlap (setting zones)	→page 1-40
Setting the scale display position and divisions	
Setting the base position and divisions of the bar graph display	
Enabling the partial expanded display	→page 1-40 →page 1-114
Displaying the color scale band (band area (in, out), color)	
Displaying alarm point marks (mark kind, alarm mark color)	→page 1-40
Displaying on/off (1/0) signals with characters (when the range type is DI)	

### Performing Calibration Correction

Item	Reference
Performing calibration correction (linearizer approximation, linearizer bias, correction factor)	→page 1-53

## Configuring Digital Input Channels (Setting menu: DI channel settings)

Source module: Digital input module (GX90XD)  
Digital input/output module (GX90WD)

### Setting the Range

Item	Reference
Setting the input range (type, span lower, span upper)	
Performing input calculation (delta, linear scaling)	→page 1-57

### Setting Alarms

Item	Reference
Setting alarms (type, value, hysteresis, logging, output type, alarm delay)	→page 1-58

### Setting the Display

Item	Reference
Setting channel tags (characters, No.)	
Setting Display Colors	
Dividing display areas to prevent waveform overlap (setting zones)	
Setting the scale display position	→page 1-60
Setting the base position and divisions of the bar graph display	
Displaying alarm point marks (mark kind, alarm mark color)	
Displaying on/off (1/0) signals with characters	

## Configuring Pulse Input Channels (Setting menu: Pulse input channel settings)

### Setting the Range

Source module: Pulse input module (GX90XP)

Item	Reference
Input range (type, range, chattering filter, span lower, span upper)	
Performing input calculations (delta, linear scaling)	→page 1-63
Taking the moving average of input values (suppressing noise)	

### Setting Alarms

Item	Reference
Setting alarms (type, value, hysteresis, logging, output, alarm delay)	→page 1-65

**Setting the Display**

Item	Reference
Setting channel tags (characters, No.)	
Setting display colors	
Dividing display areas to prevent waveform overlap (setting zones)	→page 1-66
Setting the scale display position and divisions	
Setting the base position and divisions of the bar graph display	
Enabling the partial expanded display	→page 1-40 →page 1-114
Displaying the color scale band (band area (in, out), color)	
Displaying alarm point marks (mark kind, alarm mark color)	→page 1-66

**Configuring Analog Output Channels (Setting menu: AO channel settings)**

Source module: Analog output module (GX90YA)

**Setting the Range**

Item	Reference
Setting the range (type, range, span lower, span upper)	
Setting the reference channel (channel type, CH number)	→page 1-70
Setting preset values	
Setting preset actions (at power on, on error, during stop conditions)	

**Setting the Display**

Item	Reference
Setting channel tags (characters, No.)	
Setting display colors	
Dividing display areas to prevent waveform overlap (setting zones)	→page 1-74
Setting the scale display position and divisions	
Setting the base position and divisions of the bar graph display	

**Configuring Digital Output Channels (Setting menu: DO channel settings)**

Source module: Digital output module (GX90YD)

Digital input/output module (GX90WD)

**Setting the Range**

Item	Reference
Setting the range (type, span lower, span upper, unit)	
Setting the action (energize/de-energize, action (and, or, reflash), hold, relay action on ACK)	→page 1-76

**Setting the Display**

Item	Reference
Setting channel tags (characters, No.)	
Setting Display Colors	
Dividing display areas to prevent waveform overlap (setting zones)	→page 1-80
Setting the scale display position and divisions	
Setting the base position and divisions of the bar graph display	
Displaying on/off (1/0) states with characters	

### 3. Displaying Measured Data

Measured data acquired in the internal memory can be displayed on the operation screen as trend waveforms, values, or bar graphs. In addition, in accordance with the application or the situation at the actual site, measured data can be displayed on a monitor screen (custom display (ICG option)) that the user designs using DXA170 DAQStudio. A list of alarm conditions can be displayed.

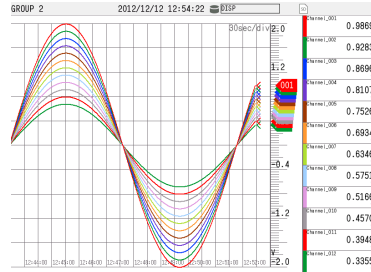

Trend



Digital

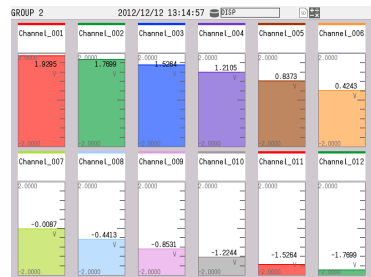

Bar graph

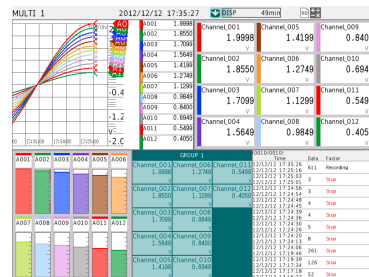

Multi panel

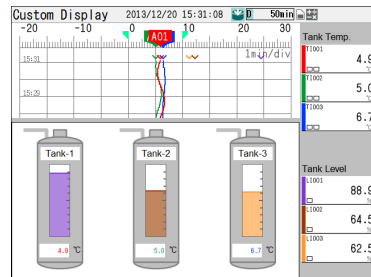

Custom display



## Configuring the display settings (Setting menu: Display settings)

### Setting the Trend Interval

Item	Reference
Setting the trend interval (/div)	→page 1-110
Using the second trend interval	

### Configuring the Display

Item	Reference
Setting the bar graph display direction, LCD brightness, view angle (GX10/GP10 only) and backlight saver	→page 1-117
Setting the monitor background color, scroll time, and jump default display	
Setting the first weekday of the calendar display	
Enabling changes to each value (alarm values, DO output operation) from the monitor display	

### Setting Trend Display Conditions

Item	Reference
Setting the trend display direction, trend line, and grid	→page 1-114
Clearing displayed waveforms when recording starts	
Configuring the trend scale settings (digit, value indicator, digit of mark)	
Enabling the trend partial expanded display	
Setting the message writing feature for power failures and trend interval changes (power-fail message, change message)	

### Setting Display Groups

Item	Reference
Setting group names and channels	→page 1-111
Displaying the scale using the scale image you created	
Displaying lines at specified positions in the waveform display range (trip line) (trend display)	

### Setting messages

Item	Reference
Setting messages	→page 1-113

## 4. Saving Data

Measured data is recorded to internal memory. Recorded measurement data can be automatically saved to an SD memory card or retrieved on a USB flash memory device. AI channels, DI channels, DO channels, math channels, communication channels as well as information such as reports, alarms, messages, and time stamps are saved.

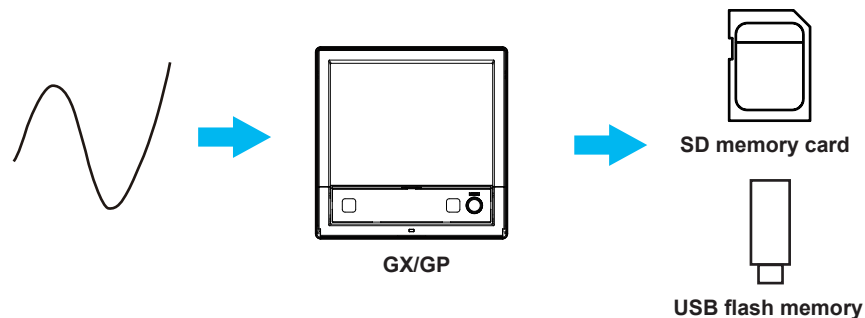

## Setting Recording Conditions (Setting menu: Recording settings, Dual interval settings)

Item	Reference
Setting the type of recording data (display data, event data)	
Setting the interval for saving data files of display data	
Setting the recording interval of event data, recording mode (free, trigger), and recording time.	→page 1-125
Setting the record confirmation screen (record start, record stop) display for when the <b>START/STOP</b> key is used	
Setting the measurement data (display data, event data, manual sampled data) channels to record (IO channel, math channel, communication channel)	→page 1-133
When the measurement mode is set to dual interval (Dual interval settings)	
Item	Reference
Setting the recording interval of event data, recording mode (free, trigger), and recording time.	→page 1-138
Setting the channels on which to record event data (Measurement group 1, measurement group 2) and manual sampled data (I/O channel, Math channel, Communication channel)	→page 1-140

## Setting Conditions for Saving Data Files (Setting menu: Data save settings)

Item	Reference
Setting the data file's save directory, file header, and data file name	→page 1-141
Setting how to save data files to the storage medium (auto save, manual save)	
Configure the GX/GP so that when there is no free space on the storage medium during auto saving, files are deleted in order starting with the oldest file and new files are saved. (Media FIFO)	→page 1-143
Setting the file format of display data and event data (binary, text)	→page 1-147

## Setting the Batch Function (Setting menu: Batch settings)

Item	Reference
Enabling the batch function and setting the lot number digits and auto incrementation	→page 1-148
Setting batch text	

## 5. Event Action Function

The event action function is used to execute a specified action when certain events occur.

For example, you can use the event action function to do the following:

- a) Start recording when the remote control input (DI channel) turns on.
- b) Record a message when an alarm occurs.
- c) Create a record file at a specific time.

## Configuring the Event Action Function (Setting menu: Event action)

Item	Reference
Configuring the event action	→page 1-162
Event action examples	→page 1-170

## Setting Timers (Setting menu: Timer settings)

Item	Reference
Setting timers (type (relative timer, absolute timer), interval, action on math start, reference time)	→page 1-159
Setting the match time timer (type, timer match condition, timer action)	→page 1-160

## 6. Computation and Report Functions (/MT option)

You can use math channels to write expressions that refer to measured data and math data as variables.

The maximum or minimum value in measured data recorded over a day or the sum of the measured data recorded over a day can be recorded.

### Setting Math Channels (/MT option) (Setting menu: Math channel settings)

#### Setting Expressions

Item	Reference
Setting expressions (expression, decimal place, span (upper, lower), unit)	
Setting the TLOG computation (timer type, timer No., sum scale, reset)	→page 1-84
Performing rolling average	
How to write expressions	→page 1-91
Setting constants to use in computation	→page 1-105

#### Setting Alarms

Item	Reference
Setting alarms (type, value, hysteresis, logging, output, alarm delay)	→page 1-101

#### Setting the Display

Item	Reference
Setting channel tags (characters, No.)	
Setting display colors	
Dividing display areas to prevent waveform overlap (setting zones)	→page 1-102
Setting the scale display position and divisions	
Setting the base position and divisions of the bar graph display	
Enabling the partial expanded display	→page 1-102 →page 1-114
Displaying the color scale band (band area (in, out), color)	
Displaying alarm point marks (mark kind, alarm mark color)	→page 1-102

#### Setting Constants

Item	Reference
Setting constants to use in computation	→page 1-105
Setting Variable Constants to Use in Computation	→page 1-106

#### Setting the Computation Operation

Item	Reference
Setting error displays (+over, -over)	
Starting recording and computation simultaneously	→page 1-83
Setting how to process computation overflow data	

#### Setting Internal Switches

Item	Reference
Setting internal switch types (alarm, manual), action (and, or)	→page 1-210

### Configuring the Report Function (/MT option) (Setting menu: Report settings)

Item	Reference
Setting the report type, creation time, data type, file type (combine, separate), and report template output (Excel, PDF, printer)	→page 1-151
Setting the PDF electronic signature	→page 1-151
Setting the channels to output reports	→page 1-154
Using the report template function	→page 1-156

## Configuring Logic Math Settings (/MT option) (Setting menu: Logic math settings)

Item	Reference
Configuring Logic Math (Output, calculation expression)	→page 1-107

## 7. Configuring System Settings

You can change the displayed language, date and time, network printer settings, operation sound, warning sound, etc.

### Configuring System Settings (Setting menu: System settings)

#### Setting the Displayed Language, Temperature unit and Decimal Point Type

Item	Reference
Setting the displayed language, Temperature unit and decimal point type (point, comma)	→page 1-205

#### Setting the Date and Time, Time Zone, Time Adjustment Function, and DST (Daylight saving time)

Item	Reference
Setting the date and time	→page 1-26
Setting the time offset from Greenwich Mean Time (time zone)	
Setting the function that gradually adjusts the time when the time is changed in the middle of recording	→page 1-207
Setting the date format	→page 1-205
Setting the DST (daylight saving time)	→page 1-207

#### Setting the FAIL Output and Instrument Information Output (/FL option)

Item	Reference
Setting the FAIL output and instrument information output	→page 1-211

#### Configuring the Printer

Item	Reference
Setting the printer output conditions (IP address, paper size, paper orientation, resolution, number of copies, snapshot, fit to page size)	→page 1-213

#### Configuring the Sound and LED Settings

Item	Reference
Enabling touch and warning sounds	
Displaying alarm status with LEDs	→page 1-214

#### Setting Instrument Tags

Item	Reference
Setting the GX/GP's instrument tag and instrument tag No.	→page 1-214

#### Setting Comments to Setting Files

Item	Reference
Setting comments to setting files	→page 1-215

#### Setting USB Input Devices

Item	Reference
Setting USB input devices (keyboard type, execution of communication commands using bar codes)	→page 1-216

### Setting the Alarm Basic Operation (Setting menu: System settings)

Item	Reference
Setting the interval for calculating the rate of change for rate-of-change alarms (decrease, increase)	→page 1-206
Setting the alarm display hold/nonhold and individual alarm ACK operation	

## 8. Security Function

You can set the lock function to prohibit tap operations and also allow only registered users to operate the GX/GP.

### Configuring the Security Function (Setting menu: Security settings)

#### Basic Settings

Item	Reference
Applying security features to tap operation and communication (login, ope lock)	
Automatically logging out users when there is no tapping activity for a specified time (login)	→page 1-220
Setting items to lock the operation of (ope lock)	→page 1-221
Registering users (administrators, users) (login)	→page 1-224
Setting user limitation conditions (login)	→page 1-225

## 9. Communication Function

You can use the communication interface (Ethernet or serial) to perform the following operations.

- Configure and operate the GX/GP.
- Monitor the GX/GP measured data.
- Retrieve files on the external storage medium of the GX/GP.
- Automatically transfer measurement data files to an FTP server.
- Monitor and configure the GX/GP through a Web browser.
- Transmit e-mails to specified addresses when alarms and other events occur.
- Read data from a device connected to the network or write GX/GP data.

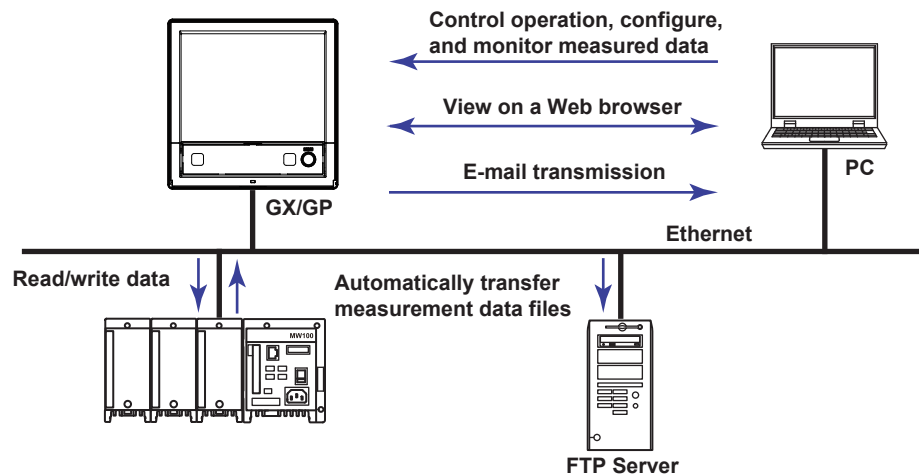

### Configuring the Ethernet Communication Function (Setting menu: Communication (Ethernet) settings)

#### Configuring Basic Settings

Item	Reference
Automatically obtaining the IP address (DHCP) or setting it manually	
Automatically obtaining the DNS server addresses or manually setting them (primary, secondary, domain suffixes)	→page 1-182
Setting the host information	
Registering the host name	

#### Configuring the FTP Client Function (File transfer from the GX/GP using FTP)

Item	Reference
Enabling the FTP client function and setting the files to transfer	
Delaying data transfers to the FTP server (transfer wait time)	→page 1-184
Setting SSL encryption on data sent via FTP	
Setting the destination server (primary, secondary)	

### Configuring the SMTP Client Function (E-mail transmission)

Item	Reference
Setting the user authentication method	
Setting SSL encryption on data sent via SMTP	→page 1-186
Setting the SMTP server	
Setting the POP3 server	
Setting the e-mail transmission conditions (recipients, subject, header, cause, etc.)	→page 1-187

### Configuring the SNTP Client Function (Time synchronization via communication)

Item	Reference
Configuring the SNTP server	
Setting the query operation (interval, timeout, time adjust on start action)	→page 1-190

### Configuring the Modbus Client Function (External device connection via Modbus protocol; /MC option)

Item	Reference
Enabling the Modbus client function and configuring basic settings (communication interval, recovery action, keep connection)	
Configuring the destination server	→page 1-191
Setting the commands to transmit (type, data type, register, etc.)	

### Limiting the Connection to the Modbus Server (GX/GP)

Item	Reference
Limiting the connection to the Modbus server (GX/GP)	→page 1-195

### Configuring the Operation of the Server Functions

Item	Reference
Setting the operation of the server functions (keep alive, timeout, FTP server output directory format, Modbus server delay response)	→page 1-194

### Setting the Server Functions to Use

Item	Reference
Setting the server functions to use (FTP, HTTP, SNTP, MODBUS, GENE)	→page 1-196
Setting SSL encryption on data sent and received by the FTP server and HTTP server	
Setting DARWIN compatible communication	

## Configuring the Serial Communication Function (/C2 and /C3 options) (Setting menu: Communication (serial) settings)

### Configuring Basic Settings

Item	Reference
Configuring the serial communication function (normal, Modbus master, Modbus slave, execution of communication commands using bar codes)	
Setting communication conditions (baud rate, parity, handshake, etc.)	→page 1-200
Setting auto logout	

### Configuring the Modbus Master Function

Item	Reference
Configuring the Modbus master function (communication interval, communication timeout, gap between messages, recovery action)	→page 1-202
Setting the Modbus master transmission commands (type, data type, register, etc.)	→page 1-203

## Setting Communication Channels (/MC option) (Setting menu: Communication channel settings)

Item	Reference
Setting communication channels (decimal place, span (upper, lower), unit)	
Replacing values with preset values when communication data is not updated for a specified time period (watchdog timer function)	→page 1-173

### Setting Alarms

Item	Reference
Setting alarms (type, value, hysteresis, logging, output, alarm delay)	→page 1-175

### Setting the Display

Item	Reference
Setting channel tags (characters, No.)	
Setting display colors	
Dividing display areas to prevent waveform overlap (setting zones)	→page 1-176
Setting the scale display position and divisions	
Setting the base position and divisions of the bar graph display	
Enabling the partial expanded display	→page 1-176
	→page 1-114
Displaying the color scale band (band area (in, out), color)	
Displaying alarm point marks (mark kind, alarm mark color)	→page 1-176

### Performing Calibration Correction

Item	Reference
Performing calibration correction (linearizer approximation, linearizer bias, correction factor)	→page 1-179

## 10. Miscellaneous

### Saving Settings to External Storage Media (Save settings)

Item	Reference
Saving setting parameters	→page 1-240
Saving scale images	→page 1-241
Saving report templates (/MT option)	→page 1-243
Saving program patterns	→page 1-246
Saving setting parameters, scale images, report templates, trusted certificates (release number 2 and later), custom display (/CG option) (release number 2 and later), and program pattern (/PG option) (release number 4 and later) at once	→page 1-244
Saving trusted certificates	→page 1-244
Saving custom displays (/CG option)	→page 1-244

### Loading Setting Files into the GX/GP from External Storage Media (Load settings)

Item	Reference
Loading setting parameters	→page 1-226
Loading scale images and clearing them from the screen	→page 1-228
Loading report templates (/MT option)	→page 1-230
Loading and deleting program patterns	→page 1-236
Loading setting parameters, scale images, report templates, trusted certificates (release number 2 and later), custom display (/CG option) (release number 2 and later), program pattern (/PG option) (release number 4 and later), and multi batch settings (/BT option) (release number 3 and later) at once	→page 1-238
Listing files that are on the external storage medium	→page 1-249
Formatting the external storage medium	→page 1-250

### Setting the Measurement Mode

Item	Reference
Setting the Measurement Mode	→page 1-256

### Initializing, Reconfiguring, and Adjusting the Touch Screen (Initialization and reconfiguration)

Item	Reference
Initializing the settings and internal memory	→page 1-251
Reconfiguring the GX/GP	→page 1-258
Adjusting the Touch Screen	→page 5-18

### Creating Keys, Managing Certificates, Viewing Certificates, and Removing Certificates

Item	Reference
Enabling the encryption function	→page 1-260
Creating keys	→page 1-260
Configuring certificate management (creating self-signed certificates, creating certificate signature requests (CSRs), installing certificates, and installing intermediate certificates)	→page 1-261
Viewing certificate details and removing certificates	→page 1-264

### Using the Aerospace Heat Treatment (/AH option) (Release number 3 and later)

Item	Reference
Setting the calibration reminder	→page 1-274
Setting calibration correction (linearizer approximation, linearizer bias, correction factor (release number 3 and later))	→page 1-53

### Setting the Future Pen Function (Release number 4 (version 4.08) and later)

Item	Reference
Setting the future pen function	→page 1-281



# Quick Setting Function (GP10/GP20, Release number 3 (Version 3.02) and later)

In Quick setting, a minimal setup menu for data collection is displayed. Quick setting allows you to collect data quickly.

Display example of the quick settings

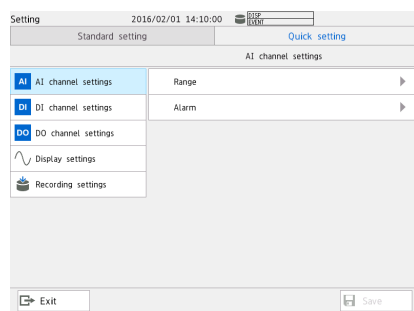

Display example of the standard settings

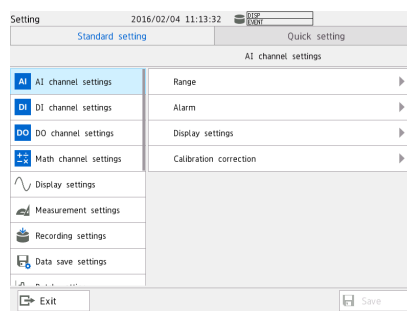

## Switching between Standard Settings and Quick Settings

Press **MENU**, and tap the **Browse** tab and then **Setting**. Tap the **Quick setting** tab or **Standard setting** tab to switch between the two modes.

Tab	Function
Quick setting	The display is switched from standard settings to quick settings. When switched to quick settings, the characters "Quick setting" turns blue.
Standard setting	The display is switched from quick settings to standard settings. When switched to standard settings, the characters "Standard setting" turns blue.

- If the GP10/GP20 is shut down when quick settings are displayed, the next time it is started, quick settings will be displayed.

### Note

- If items whose settings have been changed are unsaved, unless you cancel the settings, you will not be able to switch between standard settings and quick settings. Save the settings before switching between the two.
- If the advanced security function (/AS) is enabled (On), quick settings are disabled (Quick setting and Standard setting are not displayed).

## Quick Setting Display

The following items are displayed in quick settings.

Display item	Description
IO channel > Range	Configure settings related to the range of each I/O channel.
Input channel > Alarm	Configure settings related to the alarm of each Input channel.
Display settings	Set the trend interval. This does not appear when the file type is set to Event (default value).
Recording settings	Set the save interval of display data, recording interval of event data, and so on.
Dual interval	Configure settings related to recording by measurement groups (when the measurement mode is set to dual interval).

For details on the settings, see the description of the settings explained in this chapter.

# 1.1 Setting the Date and Time

Set the date and time.

If you need to set the time zone or DST (Daylight Saving Time) or both, do so before setting the date and time.

- ▶ See page 1-207 in section 1.23.4, “Setting the Time Zone, Gradual Time Adjustment, and Daylight Saving Time”

## Path

GX/GP:MENU key > **Universal** tab > **Date/Time setting**

Web application: **Operation** tab > **Date/Time setting**

## Description

Setup Item	Selectable Range or Options	Default Value
Date	2001 to 2035	—
Time	—	—

## Date/time Settings

Set the date using the calendar and the time.

## Procedure

- 1 Tap the **Date** tab. Use the switch icons to set the **Year** and **Month**. The year and month are set.

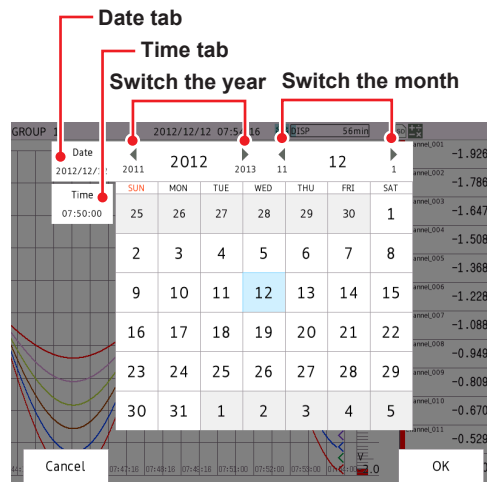

The content of the screen varies depending on the Date format setting.

- ▶ See page 1-205 in section 1.23.1, “Setting the Display Language, Temperature Unit, Decimal Point Type, and Date Format”

- 2 Tap the **Time** tab. Enter the time using the keyboard, and tap **OK**. The time is set.

Operation complete

## 1.2 Configuring AI Channels (Analog (including DI) input) channels and AI (mA) channels

Set the AI channels' and AI (mA) channels' input range, alarm, display, and calibration correction.

Set the necessary setup items in order from the top.

### 1.2.1 Setting the Range

#### Path

GX/GP: **MENU** key > **Browse** tab > **Setting** > Setting menu **AI channel settings** or **AI (mA) channel settings** > **Range**

Web application: **Config.** tab > **AI channel settings** or **AI (mA) channel settings** >

Channel range (display example: 0001-0010) > **Range**

Hardware configurator: **AI channel settings** or **AI (mA) channel settings** > Channel range (display example: 0001-0010) > **Range**

#### Description

Setup Item	Selectable Range or Options	Default Value
First-CH	AI channel	—
Last-CH	AI channel	—

#### First-CH, Last-CH

Set the target channels. The channels that you can specify appear depending on the module configuration.

#### Range

Setup Item	Selectable Range or Options	Default Value
Type <sup>6</sup>	Skip, Volt <sup>4</sup> /GS (general signal) <sup>4</sup> /TC (thermocouple) <sup>4</sup> /RTD (resistance temperature detector) <sup>1, 4</sup> /DI (contact voltage level) <sup>4</sup> , current (0 to 20 mA) <sup>3</sup> , GS (4 to 20 mA) (general signal) <sup>3</sup> , resistance <sup>7</sup>	Volt
Range <sup>4</sup>	See "Range Details."	See "Range Details."
Span Lower <sup>6</sup>	Numeric value (depends on the range)	-2.0000
Span Upper <sup>6</sup>	Numeric value (depends on the range)	2.0000
Calculation <sup>6</sup>	Off, Delta, Linear scaling, Square root, log input <sup>5</sup> , pseudo-log input <sup>5</sup> , linear-log input <sup>5</sup>	Off
Reference channel <sup>2</sup>	Number (I/O channel number)	—

1 Cannot be specified for the electromagnetic relay type (Type suffix code -T1), low withstand voltage relay type (Type suffix code -L1) or high withstand voltage type (Type suffix code -V1) analog input module.

2 Appears when Calculation is set to **Delta**.

3 Appears for AI (mA) channels.

4 Does not appear for AI (mA) channels.

5 Appears on models with the log scale (/LG) option when the range type is **Volt**.

6 The default values of AI (mA) channels are **GS** for Type, **4.000** for Span Lower, **20.000** for Span Upper, and **Linear scaling** for Calculation.

7 Appears for 4-wire RTD/resistance type channels

#### Type

Set the input signal type.

Options	Description
Skip	Not measured.
Volt, GS, TC, RTD, DI, Resistance	Input type. Represents DC voltage, GS (0.4-2V, 1-5V inputs), thermocouple, current (0 to 20 mA), RTD, ON/OFF input, current (0 to 20 mA), GS (4 to 20 mA general signal), and resistance, respectively.

## 1.2 Configuring AI Channels (Analog (including DI) input) channels and AI (mA) channels

### Note

For the channels in which you are not using an electromagnetic relay type module, set the range type to Skip.

### Range

Set the input type range.

#### Range Details

Type	Range	Selectable Range	Default Value	Notes
Volt (DC voltage)	20mV	-20.000 mV to 20.000 mV	2V	
	60mV	-60.00 mV to 60.00 mV		
	200mV	-200.00 mV to 200.00 mV		
	1V	-1.0000 V to 1.0000 V		
	2V	-2.0000 V to 2.0000 V		
	6V	-6.000 V to 6.000 V		
	20V	-20.000 V to 20.000 V		
	50V	-50.00 V to 50.00 V		
	100V	-100.00V to 100.00V		For the high-speed universal type
	DI	LVL (level)	On (1)/off (0) (voltage)	LVL
DI (contact)		On (1)/off (0) (contact)		
GS (general signal)	0.4-2V	0.3200 V to 2.0800 V	1 - 5 V	
	1-5V	0.800 V to 5.200 V		
DC current (0 to 20 mA)	—	0.000 mA to 20.000 mA	—	
	GS (4 to 20 mA)	3.200 mA to 20.800 mA	—	
TC (thermocouple)	R	0.0 to 1760.0°C	K	Type R
	S	0.0 to 1760.0°C		Type S
	B	0.0 to 1820.0°C		Type B
	K	-270.0 to 1370.0°C		Type K
	K-H	-200.0 to 500.0°C		Type K (high precision)
	E	-270.0 to 800.0°C		Type E
	J	-200.0 to 1100.0°C		Type J
	T	-270.0 to 400.0°C		Type T
	N	-270.0 to 1300.0°C		Type N
	W	0.0 to 2315.0°C		Type W
	L	-200.0 to 900.0°C		Type L
	U	-200.0 to 400.0°C		Type U
	WRe3-25	0.0 to 2320.0°C		Type WRe (WRe3-25)
	PLATINEL	0.0 to 1395.0°C		
	PR20-40	0.0 to 1900.0°C		
	KpvsAu7Fe	0.0 to 300.0K		Kp vs Au7Fe
	NiNiMo	0.0 to 1310.0°C		
WVRe26	0.0 to 2320.0°C		W/WRe26	
N14	0.0 to 1300.0°C		Type N(AWG14)	
XK	-200.0 to 600.0°C		XK GOST	
RTD (resistance temperature detector)	Pt100	-200.0 to 850.0°C	Pt100	
	Pt100-H	-150.00 to 150.00°C		Pt100 (high resolution)
	JPt100	-200.0 to 550.0°C		
	JPt100-H	-150.00 to 150.00°C		JPt100 (high resolution)
	Cu10GE	-200.0 to 300.0°C		Cu10(GE)
	Cu10LN	-200.0 to 300.0°C		Cu10 (L&N)
	Cu10WEED	-200.0 to 300.0°C		Cu10 (WEED)
	Cu10BAILEY	-200.0 to 300.0°C		Cu10 (BAILEY)
	Cu10a392	-200.0 to 300.0°C		Cu10: $\alpha = 0.00392$ at 20°C
	Cu10a393	-200.0 to 300.0°C		Cu10: $\alpha = 0.00393$ at 20°C
	Cu25	-200.0 to 300.0°C		Cu25: $\alpha = 0.00425$ at 0°C
	Cu53	-50.0 to 150.0°C		Cu53: $\alpha = 0.00426035$ at 0°C
	Cu100	-50.0 to 150.0°C		Cu100: $\alpha = 0.00425$ at 0°C
	J263B	0.0 to 300.0K		J263*B
	Ni100SAMA	-200.0 to 250.0°C		Ni100(SAMA)
	Ni100DIN	-60.0 to 180.0°C		Ni100(DIN)
	Ni120	-70.0 to 200.0°C		
Pt25	-200.0 to 550.0°C			

Continued on next page

## 1.2 Configuring AI Channels (Analog (including DI) input) channels and AI (mA) channels

Type	Range	Selectable Range	Default Value	Notes
RTD (resistance temperature detector)	Pt50	-200.0 to 550.0°C	Pt100	
	Pt200WEED	-100.0 to 250.0°C		Pt200(WEED)
	Cu10G	-200.0 to 200.0°C		Cu10 GOST
	Cu50G	-200.0 to 200.0°C		Cu50 GOST
	Cu100G	-200.0 to 200.0°C		Cu100 GOST
	Pt46G	-200.0 to 550.0°C		Pt46 GOST
	Pt100G	-200.0 to 600.0°C		Pt100 GOST
Resistance	Pt500	-200.0°C to 850.0°C		For the 4-wire RTD/ resistance type
	Pt1000	-200.0°C to 850.0°C		For the 4-wire RTD/ resistance type
	20Ω	0.000Ω to 20.000Ω	200Ω	
	200Ω	0.00Ω to 200.00Ω		
	2000Ω	0.0Ω to 2000.0Ω		

### Span Lower, Span Upper

Set the input range. The selectable range varies depending on the range setting. For the selectable ranges, see “Range Details.”

#### Note

- You cannot set the same value to **Span Lower** and **Span Upper**.

### Calculation

When performing input calculation, set the calculation type.

#### • Linear scaling

Converts the unit to obtain the measured value.

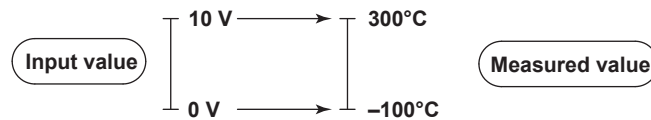

#### • Delta

Difference calculation. The measured value of the channel is set to the difference with respect to the measured value of the reference channel.

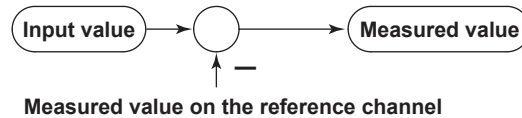

## 1.2 Configuring AI Channels (Analog (including DI) input) channels and AI (mA) channels

### Note

Difference calculation is executed even if the input type or range is not the same between the difference calculation channel and the reference channel.

Differences in the decimal place is considered but the difference in the unit is ignored in the calculation. Then, the decimal place and the unit of the difference calculation channel are applied.

Example 1: If the input value of the difference calculation channel is 10.00 and the measured value of the reference channel is 100.0, the calculated result is  $10.00 - 100.0 = -90.00$ .

Example 2: If the input value of the difference calculation channel is 10.00 V and the measured value of the reference channel is 5.00 mV, the computed result is  $10.00 \text{ V} - 5.00 \text{ mV} = 5.00 \text{ V}$ .

When the measurement mode is set to Dual interval

The measurement and computational processing between measurement groups is not synchronized. As such, if a difference calculation channel and the reference channel are in different measurement groups, it is indefinite as to which measured value of the reference channel in time will be used for the difference calculation.

- **Square Root**

Takes the square root of the input value and converts the unit to obtain the measured value.

In a differential pressure flowmeter, the output signal is proportional to the square of the flow rate. Therefore, to measure on a recorder, square rooting is required.

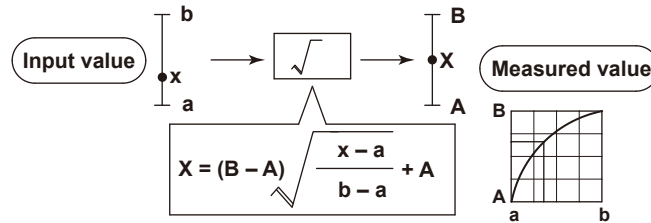

### Reference channel

Set the reference channel for the difference calculation.

You cannot specify an AO channel.

### Scale<sup>1</sup>

Setup Item	Selectable Range or Options	Default Value
Decimal Place	0, 1, 2, 3, 4, 5	2
Scale Lower	-999999 to 999999	0.00
Scale Upper	-999999 to 999999	100.00
Unit	Character string (up to 6 characters, <u>Aa#1</u> )	—

<sup>1</sup> Appears when math is set to **Linear scaling** or **Square root**.

### Decimal Place

Set the decimal place of the scale for linear scaling and square rooting.

### Span Lower, Scale Upper

Assign values to the results of unit conversion of linear scaling and square rooting.

### Note

- The GX/GP converts measured values to values within the range set by the **Scale Lower** and **Scale Upper** values with their decimal points removed. For example, if the scale setting is “-5 to 5,” values are converted to values within the span of “10”; if the scale setting is “-5.0 to 5.0,” values are converted to values within a span of “100.” In this case, the resolution of values converted to a span of “10” is lower than those converted to a span of “100.” To prevent the display from becoming coarse, it is recommended that the scale be set so that the span is greater than 100.
- You cannot set the same value to **Scale Lower** and **Scale Upper**.

### Unit

Set the unit.

## 1.2 Configuring AI Channels (Analog (including DI) input) channels and AI (mA) channels

### Low-cut<sup>1</sup>

Setup Item	Selectable Range or Options	Default Value
On/Off	Off, On	Off
Low-cut value <sup>2</sup>	0.0% to 5.0%	0.0
Low-cut output <sup>3</sup>	Output 0%, Output linear	Output 0%

- 1 Appears when the type is set to **Volt** and Calculation is set to **Square root** or when the type is set to **GS** and Calculation is set to **Linear scaling** or **Square root**.
- 2 Appears when On/Off is set to **On**.
- 3 Does not appear when the type is set to **GS** and Calculation is set to **Linear scaling**.

#### On/Off

Select **On** to use the low-cut function.

#### Low-cut value

Set the low-cut value in the range of 0.0% to 5.0% of the input span.

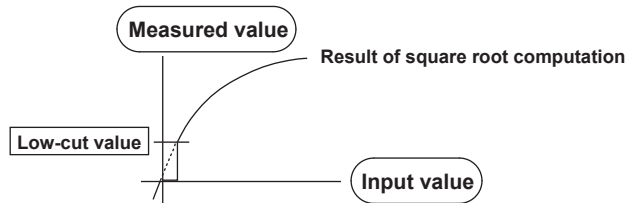

#### Low-cut output

Set the output value when the input is less than the low-cut value for when the low-cut function is in use.

Options	Description
Output 0%	Set the value for 0%.
Output linear	Outputs values that result by applying linear scaling to the input on the basis of the specified span and scale.

#### Note

When the type is set to **GS** and Calculation is set to **Linear scaling**, the low-cut output is fixed to **Output 0%**.

### Moving average

Setup Item	Selectable Range or Options	Default Value
On/Off	Off, On	Off
Count <sup>1</sup>	2 to 100 2 to 500 (high-speed AI)	2

- 1 Appears when On/Off is set to **On**.

#### On/Off

Set this to **On** to perform moving average.

#### Count

Set the number of data points to take the moving average of.

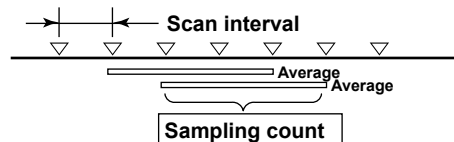

1.2 Configuring AI Channels (Analog (including DI) input) channels and AI (mA) channels

**First-order lag filter (high-speed AI module only)**

Setup Item	Selectable Range or Options	Default Value
On/Off	Off, On	Off
Filter coefficient <sup>1</sup>	3 to 300	3

<sup>1</sup> Appears when On/Off is set to **On**.

**On/Off**

Set this to **On** to use the first-order lag filter.

**Filter coefficient**

Filter time constant = scan interval × filter coefficient N

The following table shows the relationship between filter coefficient N of the first-order lag filter, scan interval, and time constant for filter coefficient N = 3, 10, 30, 100, and 300.

Scan interval	Time constant (s)				
	N = 3	N = 10	N = 30	N = 100	N = 300
1ms	0.003	0.01	0.03	0.1	0.3
2ms	0.006	0.02	0.06	0.2	0.6
5ms	0.015	0.05	0.15	0.5	1.5
10ms	0.03	0.1	0.3	1	3
20ms	0.06	0.2	0.6	2	6
50ms	0.15	0.5	1.5	5	15
100ms	0.3	1	3	10	30
200ms	0.6	2	6	20	60
500ms	1.5	5	15	50	150
1s	3	10	30	100	300
2s	6	20	60	200	600
5s	15	50	150	500	1500

**Description**

When there is noise riding on the input signal, inserting a first-order lag filter has the effect of rejecting noise. The larger the filter coefficient (time constant), the higher the noise rejection effect. However, setting the filter coefficient too large will distort the waveform.

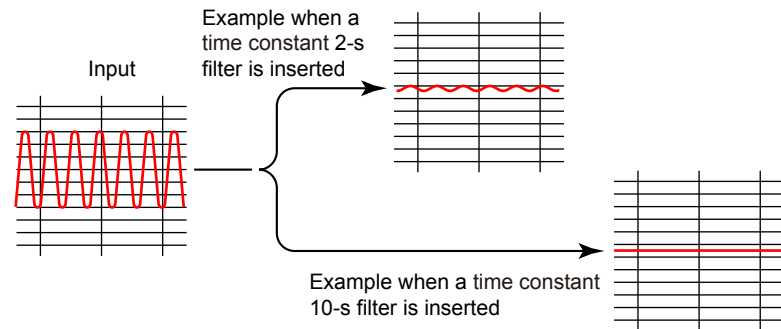
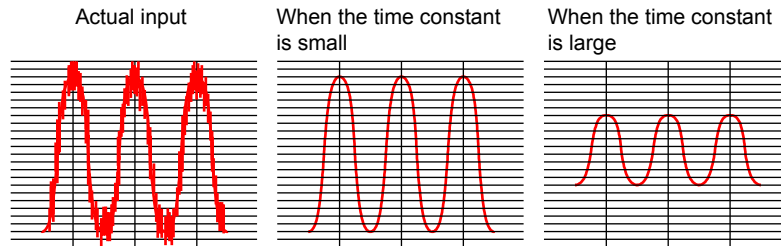



### RJC<sup>1, 3</sup> (Reference junction compensation)

Setup Item	Selectable Range or Options	Default Value
Mode	Internal/External	Internal
Temperature <sup>2</sup>	-20.0 to 80.0°C, 253.1 to 353.2K (KpvsAu7Fe) (when the measurement range is in Fahrenheit: -4.0 to 176.0, 253.1 to 353.2K)	0.0°C, 273.2K (KpvsAu7Fe)

- 1 Appears when the range type is set to **TC**.
- 2 Appears when the mode is set to **External**.
- 3 Does not appear for AI (mA) channels.

#### Mode

Set the reference junction compensation method of the thermocouple.

Options	Description
Internal	Uses the reference junction compensation function of the GX/GP.
External	Uses an external reference junction compensation function.

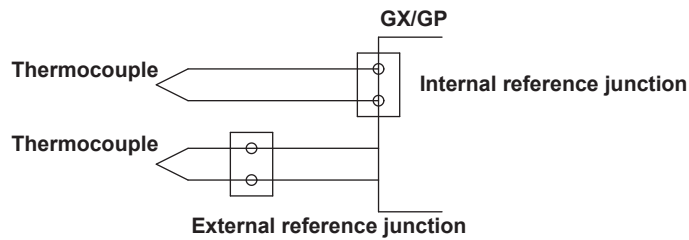

#### Temperature

When the RJC is set to external, set the compensation temperature.

1.2 Configuring AI Channels (Analog (including DI) input) channels and AI (mA) channels

**Burnout set<sup>1</sup>**

Setup Item	Selectable Range or Options	Default Value
Mode	Off, Up, Down	Off

1 Appears when the range type is set to **GS**, **GS (4-20mA)**, **TC**, or **RTD**. It is not displayed for the 4-wire RTD/resistance type.

**Mode**

When the range type is set to **TC**, **GS**, **GS (4-20mA)**, or **RTD**, the GX/GP detects sensor burnouts.

Options	Description
Off	Does not detect burnouts in the sensor.
Up	When the sensor burns out, the measured result is set to +over range. The measured value is displayed as "Burnout." When the input type is set to <b>GS</b> or <b>GS (4-20mA)</b> , the GX/GP assumes that the sensor has burned out when the measured value moves out of the range defined by the upper and lower limits of burnout specified on the specified span width. (Example: If the lower limit of burnout is set to -10% and the upper limit to 110%, when the measured value is less than -10 or greater than 110 when the scale is set to 0 to 100 in linear scaling)
Down	When the sensor burns out, the measured result is set to -over range. The measured value is displayed as "Burnout." When the input type is set to <b>GS</b> or <b>GS (4-20mA)</b> , the GX/GP assumes that the sensor has burned out when the measured value moves out of the range defined by the upper and lower limits of burnout specified on the specified span width. (Example: If the lower limit of burnout is set to -10% and the upper limit to 110%, when the measured value is less than -10 or greater than 110 when the scale is set to 0 to 100 in linear scaling)

► For details on setting the upper and lower limits of burnout, see page 1-124 in section 1.11.6, "Setting the Burnout Criteria (Release number 2 and later)".

Thermocouple Examples

**Burnout**

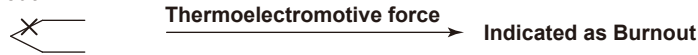

**Burnout**

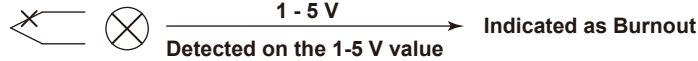

**Note**

If the scan interval is between 1 ms and 20 ms on a high-speed AI module, burnout detection will not work properly.

**Bias<sup>1</sup>**

Setup Item	Selectable Range or Options	Default Value
Value	Numeric value (-999999 to 999999)	0

1 Does not appear if the range is set to DI.

**Value**

Set the bias to add to input values or linear scaling values (input calculation).

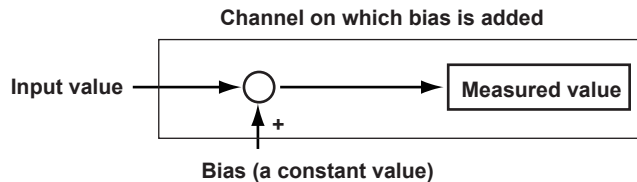

## 1.2.2 Setting Alarms

### Path

GX/GP: **MENU** key > **Browse** tab > **Setting** > Setting menu **AI channel settings** or **AI (mA) channel settings** > **Alarm**

Web application: **Config.** tab > **AI channel settings** or **AI (mA) channel settings** > **Channel range** (display example: 0001-0010) > **Alarm**

Hardware configurator: **AI channel settings** or **AI (mA) channel settings** > Channel range (display example: 0001-0010) > **Alarm**

### Description

Setup Item	Selectable Range or Options	Default Value
First-CH	AI channel	—
Last-CH	AI channel	—

#### First-CH, Last-CH

Set the target channels. The channels that you can specify appear depending on the module configuration.

#### Level 1, Level 2, Level 3, Level 4

Setup Item	Selectable Range or Options	Default Value
On/Off	Off, On	Off
Type <sup>1</sup>	H: High limit, L: Low limit, R: High limit on rate-of-change, r: Low limit on rate-of-change, T: Delay high limit, t: Delay low limit, h: Difference high limit, <sup>2</sup> l: Difference low limit <sup>2</sup>	H: High limit
Value <sup>1, 7</sup>	Within the setting range	0.0000
Hysteresis <sup>1, 4, 7</sup>	Numeric value When Calculation is set to <b>Off</b> or <b>Delta</b> : 0 to 5% of range setting When math is set to <b>Linear scaling</b> or <b>Square root</b> : 0 to 100000	0.0005
Logging <sup>1</sup>	Off, On	On
Output type <sup>1</sup>	Off, Relay <sup>5</sup> , Internal switch <sup>6</sup>	Off
Output No. <sup>3</sup>	DO channel or internal switch	—

- 1 Appears when Level (1 to 4) is set to **On**.
- 2 Appears when Calculation of the range setting is set to **Delta**.
- 3 Appears when Output type is not set to **Off**.
- 4 Appears when Type is set to high limit, low limit, difference high limit, or difference low limit.
- 5 Appears when the range type of any of the DO channels is set to Alarm.
- 6 Appears when any of the internal switch type is set to Alarm.
- 7 The default values of AI (mA) channels are **0.00** for the Alarm value and **0.05** for Hysteresis.

#### On/Off

To use an alarm level (1 to 4), set this to **On**.

## 1.2 Configuring AI Channels (Analog (including DI) input) channels and AI (mA) channels

### Type

Set the alarm type.

Options	Description
H: High limit	An alarm is activated when the measured value is greater than or equal to the alarm value.
L: Low limit	An alarm is activated when the measured value is less than or equal to the alarm value.
R: High limit on rate-of-change	An alarm is activated if the increasing rate-of-change of measured values over a certain interval is greater than or equal to the specified value.
r: Low limit on rate-of-change	An alarm is activated if the decreasing rate-of-change of measured values over a certain interval is greater than or equal to the specified value.
T: Delay high limit	An alarm is activated if measured values remain greater than or equal to the alarm value for a specified time period (delay period).
t: Delay low limit	An alarm is activated if measured values remain less than or equal to the alarm value for a specified time period (delay period).
h: Difference high limit	An alarm is activated when the difference in the measured values of two channels is greater than or equal to the specified value. This alarm can be specified on measurement channels set to difference calculation.
l: Difference low limit	An alarm is activated when the difference in the measured values of two channels is less than or equal to the specified value. This alarm can be specified on measurement channels set to difference calculation.

Alarms of channels set to difference calculation are set in the position shown in the figure below.

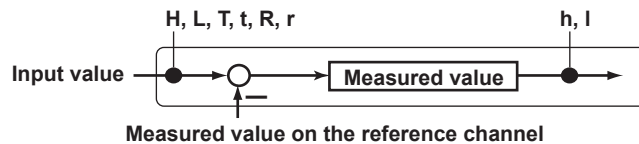

### Value

Set the alarm value for the specified alarm type.

Options	Value	Examples of Alarm Value Range
H, L	A value within the measurable range	-2.0000 to 2.0000 V for 2 V range -270.0 to 1370.0°C for thermocouple type K
R, r	1 digit to the upper limit of the width of the measurable range	0.0001 to 4.0000 V for 2 V range 0.1 to 1640.0°C for thermocouple type K
T, t	Same as H and L	Same as H and L

### When the Channel Calculation Is Set to Delta

Options	Value	Examples of Alarm Value Range
H, L	A value within the measurable range	-2.0000 to 2.0000 V for 2 V range -270.0 to 1370.0°C for thermocouple type K
h, l	A value within the measurable range	-4.0000 to 4.0000 V for 2 V range -1640.0 to 1640.0°C for thermocouple type K
R, r	1 digit to the upper limit of the width of the measurable range	0.0001 to 4.0000 V for 2 V range 0.1 to 1640.0°C for thermocouple type K
T, t	Same as H and L	Same as H and L

### When the Channel Calculation Is Set to Linear Scaling or Square Root

Options	Value	Examples of Alarm Value Range
H, L	-5% to 105% of the scale width However, within -999999 to 999999 excluding the decimal point.	-5.0 to 105.0 when the scale is 0.0 to 100.0 -120.00 to 320.00 when the scale is -100.00 to 300.00
R, r	1 to the scale width but within 1 to 999999 excluding the decimal point.	0.1 to 100.0 when the scale is 0.0 to 100.0 0.01 to 400.00 when the scale is -100.00 to 300.0
T, t	Same as H and L	Same as H and L

## 1.2 Configuring AI Channels (Analog (including DI) input) channels and AI (mA) channels

### Hysteresis

Set this to establish an offset between the value used to activate and release alarms. This is fixed at 0 for the **DI** range.

Example:

H: If you set the alarm value of a high limit alarm to 1.0000 V and the hysteresis to 0.0005 V, an alarm is activated when the measured value is greater than or equal to 1.0000 V and is released when the measured value is less than 0.9995 V.

### Logging

Set this **On** to display an alarm (notify you) when an alarm occurs. If set to **Off**, when an alarm occurs, the GX/GP outputs signals to alarm output DO channels or internal switches but does not display the alarm. Alarms are also not recorded in the alarm summary.

### Output type

Set the alarm output destination.

Alarm status can be output to the relay (DO channel) or internal switches (100 software switches). Internal switch values are shown below. Like the DO output relay, you can specify AND/OR operation.

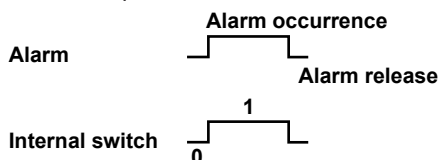

Internal switches can be used as events of the event action function (see ► page 1-162 in section 1.19, “Configuring the Event Action Function”). In addition, they can also be written in calculation expressions of math channels (/MT option).

### Output No.

Set the number of the relay (DO channel) or internal switch to output alarms to.

### Alarm delay<sup>1</sup>

Setup Item	Selectable Range or Options	Default Value
Hour	1 to 24	0
Minute	0 to 59	0
Second	0 to 59	10

<sup>1</sup> Appears when Level 1, Level 2, Level 3, or Level 4 is **On**.

### Hour, Minute, and Second

Set the alarm delay. These values are valid when the delay high limit or delay low limit is in use.

**Explanation**

**Alarm Type**

The character inside the parentheses is the symbol denoting each alarm.

<b>High Limit Alarm (H)</b>	<b>Low Limit Alarm (L)</b>
<b>Delay High Limit Alarm (T)</b>	<b>Delay Low Limit Alarm (t)</b>
<b>High Limit on Rate-of-Change Alarm (R)</b>	<b>Low Limit on Rate-of-Change Alarm (r)</b>
<b>Difference High Limit Alarm (h)</b>	<b>Difference Low Limit Alarm (l)</b>

**High Limit Alarm and Low Limit Alarm**

An alarm is activated when the measured value is greater or less than or equal to the alarm value.

**Delay High Limit Alarm and Delay Low Limit Alarm**

An alarm is activated if measured values remain greater or less than or equal to the alarm value for a specified time period (delay period).

**High Limit on Rate-of-Change Alarm and Low Limit on Rate-of-Change Alarm**

An alarm is activated if the increasing or decreasing rate-of-change of measured values over a certain interval is greater than or equal to the specified value.

The alarm value of an rate-of-change alarm is set using an absolute value. The interval is derived using the following equation and set using the number of samples.

Interval = the scan interval × the number of samples

- For the number of samples, see page 1-206 in section 1.23.2, “Setting the Interval for Calculating the Rate-of-Change for Rate-of-Change Alarms”.

**Difference High Limit Alarm and Difference Low Limit Alarm**

An alarm is activated when the difference in the measured values of two channels is greater or less than or equal to the specified value.

This alarm can be specified on measurement channels set to difference calculation.

---

## 1.2 Configuring AI Channels (Analog (including DI) input) channels and AI (mA) channels

### Alarm Detection and Output When the Scan Interval Is Shorter Than 100 ms

Alarm is detected every 100 ms. All alarms are detected and recorded in the alarm summary.

Internal switch and relay output generated by alarms occur at 100 ms intervals.

### 1.2.3 Setting the Display

#### Path

GX/GP: **MENU** key > **Browse** tab > **Setting** > Setting menu **AI channel settings** or **AI (mA) channel settings** > **Display settings**  
 Web application: **Config.** tab > **AI channel settings** or **AI (mA) channel settings** > **Channel range** (display example: 0001-0010) > **Display settings**  
 Hardware configurator: **AI channel settings** or **AI (mA) channel settings** > Channel range (display example: 0001-0010) > **Alarm** > **Display settings**

#### Description

Setup Item	Selectable Range or Options	Default Value
First-CH	AI channel	—
Last-CH	AI channel	—

#### First-CH, Last-CH

Set the target channels. The channels that you can specify appear depending on the module configuration.

#### Tag

Setup Item	Selectable Range or Options	Default Value
Characters	Character string (up to 32 characters, <b>Aa#1</b> )	—
No.	Character string (up to 16 characters, <b>Aa#1</b> )	—

#### Characters

Set the tag.  
 Not all characters may be displayed due to space constraints.

#### No.

Set the tag number.

#### Precedence in Displaying Characters and Numbers

Tag numbers are displayed with higher precedence than tag characters.  
 When tag numbers are not assigned, tag characters are displayed.  
 If neither the tag numbers nor tag characters are assigned, channel numbers are displayed.

#### Color

Setup Item	Selectable Range or Options	Default Value
Color	24 colors (red, green, blue, blue violet, brown, orange, yellow-green, light blue, violet, gray, lime, cyan, dark blue, yellow, light gray, purple, black, pink, light brown, light green, dark gray, olive, dark cyan, and spring green) and a user-defined color (1 color)	—

#### Color

Set channel display colors. The colors apply to the trend display and bar graph display.



### Setting the User-Defined Color

- 1 Tap **Color**.  
The setup screen appears.
- 2 Tap **Advanced setting**.  
Setup keys appear in the right area.

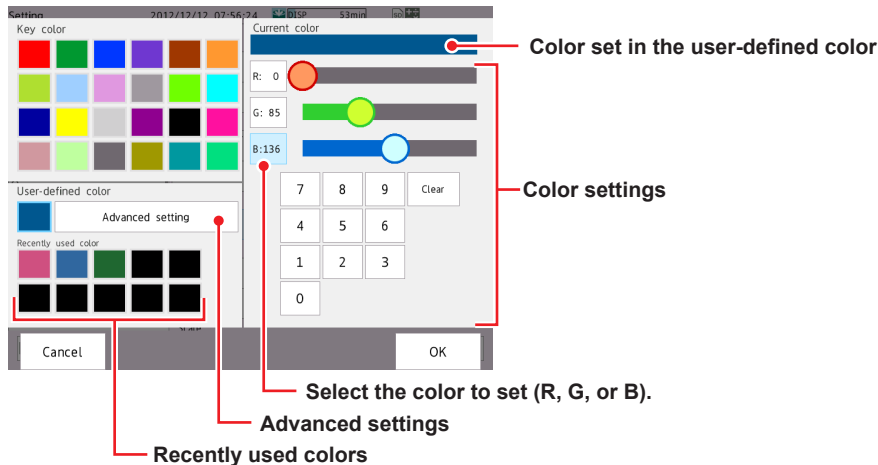

- 3 Select R, G, B one at a time, and set each value using the numeric keypad or the bars.
- 4 Tap **OK**.  
The user-defined color is set.

The color that you created is registered under **Recently used color** (up to 10 colors). You can select a color from here.

#### Operation complete

### Zone

Setup Item	Selectable Range or Options	Default Value
Lower	0 to 95%	0
Upper	5 to 100%	100

#### Lower and Upper

Set these values when you want to divide the waveform displays of channels into separate zones so that waveforms do not overlap. Set the **Lower** and **Upper** positions as percentages of the maximum display width. Set **Lower** to a value less than **Upper**, and set the zone width (**Upper – Lower**) to be 5% or greater.

Example:

Set the channel 1 zone to 0 to 30%, the channel 2 zone to 30 to 60%, and the channel 3 zone to 60 to 100%.

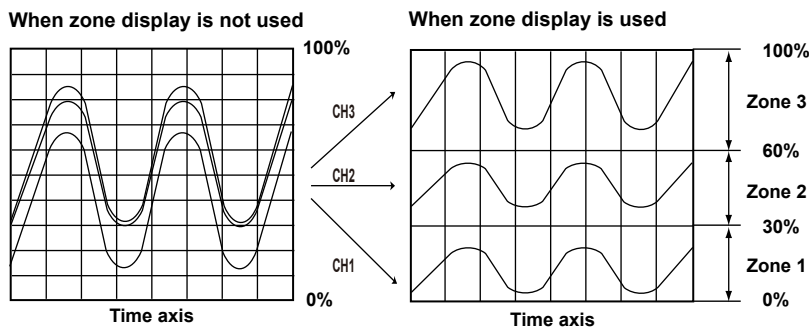

1.2 Configuring AI Channels (Analog (including DI) input) channels and AI (mA) channels

**Scale**

Setup Item	Selectable Range or Options	Default Value
Position	GX20/GP20: Off, 1, 2, 3, 4, 5, 6, 7, 8, 9, 10 GX10/GP10: Off, 1, 2, 3, 4, 5, 6	1
Division	4, 5, 6, 7, 8, 9, 10, 11, 12, C10	10

**Position**

Set the scale display positions when you want to display multiple scales on the trend display. Set this to **Off** to not display scales.

**Division**

Set the number of divisions to make with the main scale marks. C10: The scale is equally divided into 10 sections by main scale marks, and scale values are indicated at 0, 30, 50, 70, and 100% positions.

The figure below is an example in which each scale is displayed with the position shifted.

**Horizontal Trend Display**

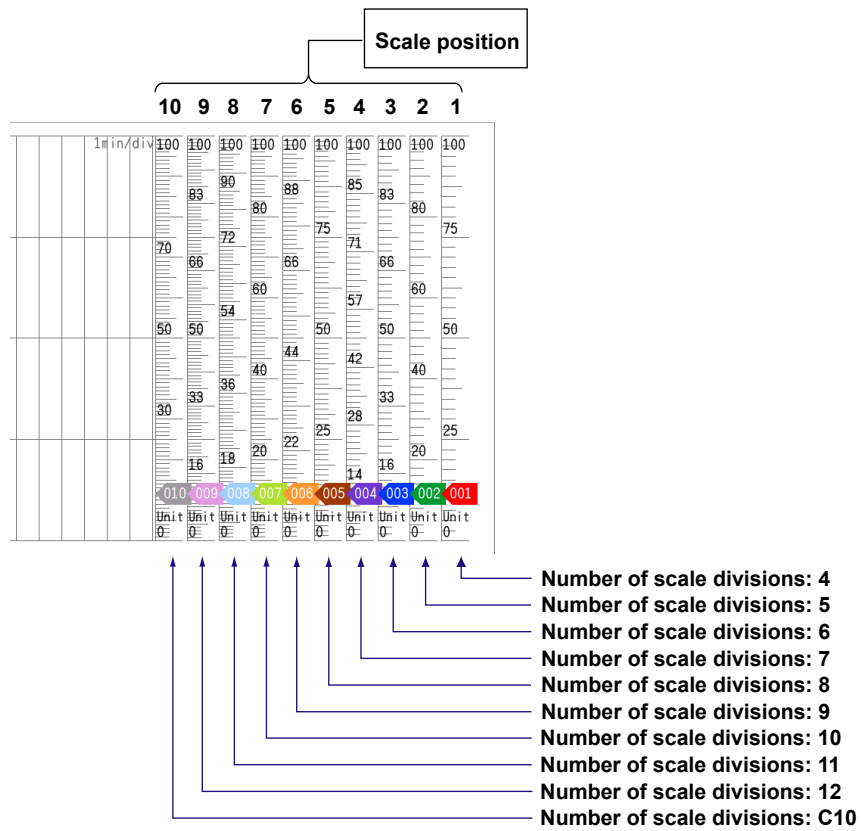

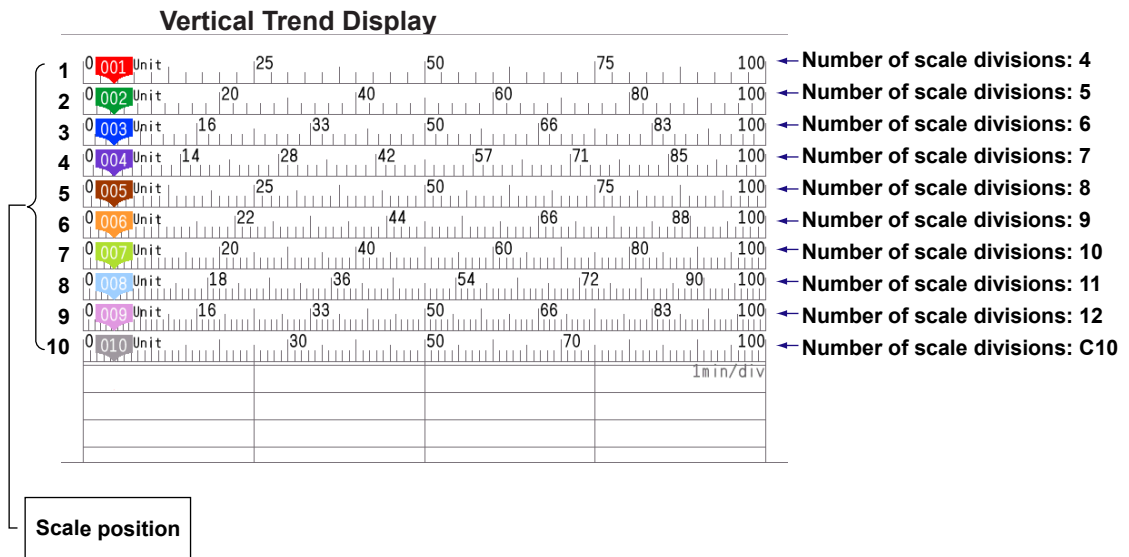

**Note**

- If the scales of multiple channels are set to the same position, the scale of the channel assigned first to the group is displayed.  
Example: If the order of assignment of a group is 0003.0002.0001, and the scale display position of all channels is set to 1, the scale of channel 3 is displayed at display position 1.
- Even if some of the scale display positions are skipped, the scale is packed towards display position 1.  
Example: Suppose the assignment of channels to a group is 0001.0002.0003, and the display positions of the scales are set to 1, 3, and 6, respectively. The scales are actually displayed at positions 1, 2, and 3, respectively.
- The scale is divided into 4 to 12 sections by the main scale marks. The section between the main scale marks is divided into 5 or 10 subsections by medium and small scale marks. However, small scale marks are not displayed in the following cases.
  - When the resolution of the input range is smaller than the total number of small scale marks.
  - When zone display is used.
  - When partial expanded display is used (numbers are displayed at the ends of the scale and at the boundary position).
- The scale values are displayed according to the following rules.
  - If the number of scale divisions is 4 to 7 for the vertical trend display, values are displayed at all main scale marks. If the number of scale divisions is 8 to 12, the values are displayed at every other main scale marks.
  - Scale upper and lower limits are displayed at the ends of the scale.
  - Scale values are displayed up to three digits excluding the minus sign. However, if the integer part of values at the ends of the scale is both one digit or the integer part is zero, two digits are displayed.  
Example: If the scale is -0.05 to 0.50, the lower limit is "-0.0" and the upper limit is "0.5."
  - If the integer part of either end of the scale is two or three digits, the fractional part is truncated.  
Example: If the scale is 0.1 to 100.0, the lower limit is "0" and the upper limit is "100."
  - If the integer part of either end of the scale is four or more digits, the value is displayed using a three-digit mantissa and exponent like " $\times 10$ " or " $\times 10^2$ ".  
Example: If the scale is 10 to 2000, the lower limit is "1" and the upper limit is "200  $\times 10$ ".
- The unit is displayed near the lower limit. If partial expanded display is used, it is displayed near the boundary line. The number of characters that can be displayed is up to six.

### Bar graph

Setup Item	Selectable Range or Options	Default Value
Base position	Lower, Center, Upper	Lower
Division	4, 5, 6, 7, 8, 9, 10, 11, 12	10

#### Base position

Set the bar graph base position. Depending on the setting, the bar graph is displayed as follows. This setting is applied on the bar graph display and when you are displaying the current value on the scale as a bar graph on the trend displays.

#### When the Display Direction of the Bar Graph Is Vertical

The span lower limit (or scale lower limit) is at the bottom edge of the bar graph, and the span upper limit (or scale upper limit) is at the top edge of the bar graph.

Starting point of the bar

- Center: Center
- Lower: Bottom edge
- Upper: Top edge

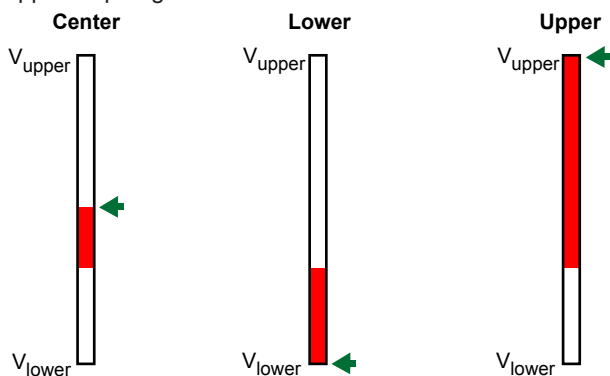

V<sub>upper</sub>: Span upper limit (or scale upper limit)  
 V<sub>lower</sub>: Span lower limit (or scale lower limit)  
 ← : Starting point of the bar

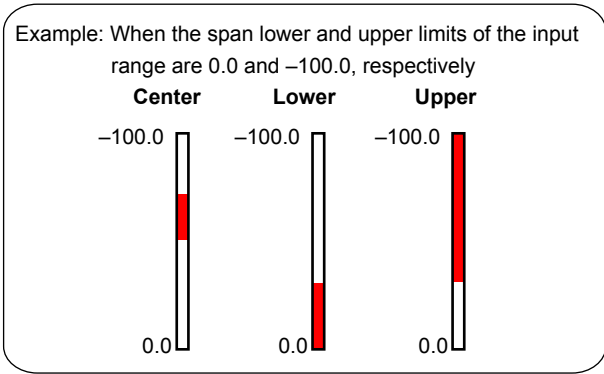

**When the Display Direction of the Bar Graph Is Horizontal**

The span lower limit (or scale lower limit) is at the left edge of the bar graph, and the span upper limit (or scale upper limit) is at the right edge of the bar graph.

Starting point of the bar

- Center: Center
- Lower: Left edge
- Upper: Right edge

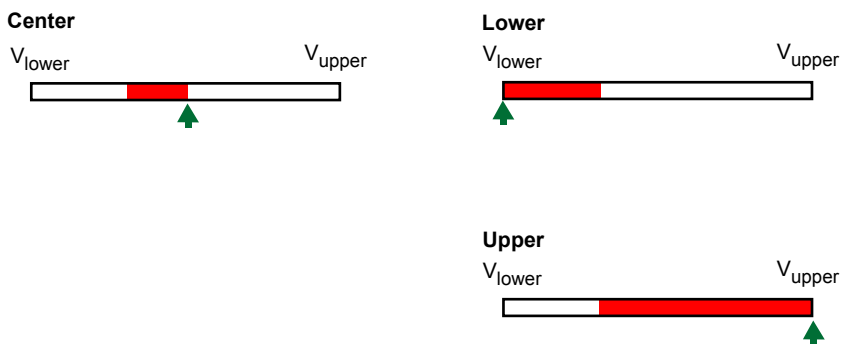

$V_{upper}$ : Span upper limit (or scale upper limit)  
 $V_{lower}$ : Span lower limit (or scale lower limit)  
 ▲ : Starting point of the bar

Example: When the span lower and upper limits of the input range are 0.0 and -100.0, respectively

	0.0	-100.0
<b>Center</b>		
<b>Lower</b>		
<b>Upper</b>		

**When Displaying the Current Value on the Scale Using the Bar Graph**

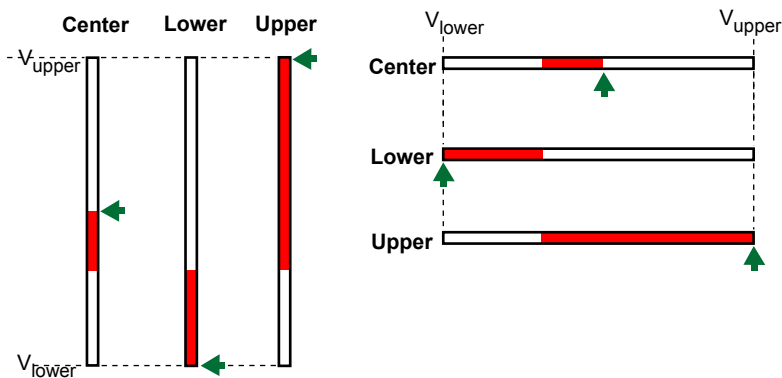

**Division**

Set the number of divisions to make with the main scale marks.

## 1.2 Configuring AI Channels (Analog (including DI) input) channels and AI (mA) channels

### Partial<sup>1</sup>

Setup Item	Selectable Range or Options	Default Value
On/Off	Off, On	Off
Expand	1 to 99(%)	50%
Boundary	Span lower limit + 1 digit to span upper limit – 1 digit	0.0000

<sup>1</sup> Appears when in the **Display settings** of the setting menu, **Partial On/Off** is set to **On**.

### On/Off

Set this to **On** to enable partial expanded display of waveforms.

► For details on this function, see page 1-114 in section 1.10.4, “Setting Trend Display Conditions”.

### Expand

Set at which position to display the value specified by **Boundary** within the display width. Specify a percentage.

### Boundary

Set the value that is to be the boundary between the reduced section and the expanded section in the range of “minimum span value + 1 digit to maximum span value – 1 digit.” For channels that are set to scaling, the selectable range is “minimum scale value + 1 digit to maximum scale value – 1 digit.”

Example: Input range: –6 V to 6V. Expand: 30. Boundary: 0The –6 V to 0 V range is displayed in the 0% to 30% range, and the 0 V to 6 V range is displayed in the 30% to 100% range.

### Color scale band

Setup Item	Selectable Range or Options	Default Value
Band area	Off, In, Out	Off
Color	24 colors (red, green, blue, blue violet, brown, orange, yellow-green, light blue, violet, gray, lime, cyan, dark blue, yellow, light gray, purple, black, pink, light brown, light green, dark gray, olive, dark cyan, and spring green) and a user-defined color (1 color)	—
Display position Lower	Span (scale) lower limit to span (scale) upper limit	0.0000
Display position Upper	Span (scale) lower limit to span (scale) upper limit	0.0100

### Band area

Displays a specified section of the measurement range using a color band on the scale. This setting is shared with the bar graph display.

Options	Description
Off	Disables the function.
In	Displays the area inside using the color band.
Out	Displays the area outside using the color band.

### Color

Set the display color.

► For instructions on how to set the user-defined color, see page 1-40 in section 1.2.3, “Setting the Display”.

## 1.2 Configuring AI Channels (Analog (including DI) input) channels and AI (mA) channels

### Display position Lower and Display position Upper

Set the display position. Set a value within the span or scale range.

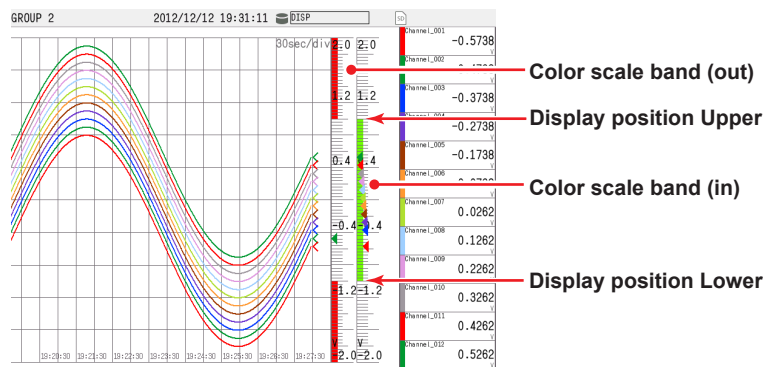

### Alarm point mark

Setup Item	Selectable Range or Options	Default Value
Indicate on Scale	Off, On	On
Mark kind	Alarm, Fixed	Alarm
Alarm 1 color to Alarm 4 color <sup>1</sup>	24 colors (red, green, blue, blue violet, brown, orange, yellow-green, light blue, violet, gray, lime, cyan, dark blue, yellow, light gray, purple, black, pink, light brown, light green, dark gray, olive, dark cyan, and spring green) and a user-defined color (1 color)	—

<sup>1</sup> Appears when the Mark kind is set to **Fixed**.

### Indicate on Scale

Set this to **On** to display alarm point marks on the scale. Set this to **Off** to not display them. This setting is shared with the bar graph display.

### Mark kind

Options	Description	Mark Shape
Alarm	Displayed normally in green. Displayed in the specified color when an alarm occurs.	▲ or ▼
Fixed	Displayed with a fixed color.	◀

### Alarm 1 color to Alarm 4 color

When Mark kind is set to **Fixed**, set the display colors of point marks for alarm levels 1 to 4.

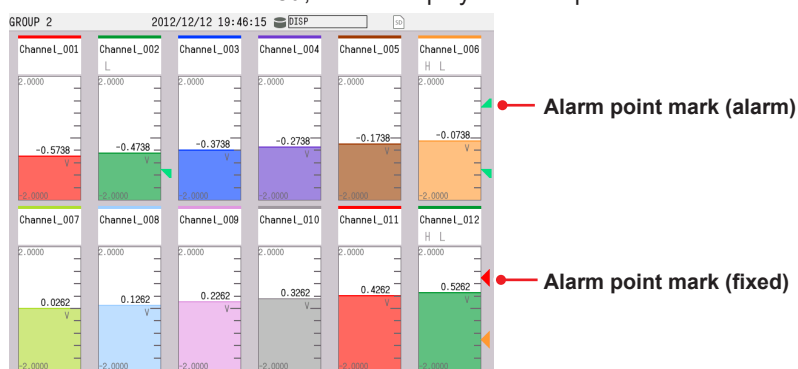

## 1.2 Configuring AI Channels (Analog (including DI) input) channels and AI (mA) channels

### Display characters of each value<sup>1</sup>

Setup Item	Selectable Range or Options	Default Value
0	Character string (up to 8 characters, <b>Aa#1</b> )	—
1	Character string (up to 8 characters, <b>Aa#1</b> )	—

<sup>1</sup> Appears when in the range settings, type is set to **DI** and Calculation is set to **Off**.

#### 0

Set the character string to display when the measured value is 0.

#### 1

Set the character string to display when the measured value is 1.

#### Examples of display characters of each value

Receive a device operation status through DI input and display measured values (0 and 1) as “Running” and “Stopped.”

You can select whether to display measured values (0 or 1) or characters.

- See page 2-10 in section 2.2.1, “Displaying Measured Data Using Waveforms, Numeric Values, Bar Graph, or Custom Display (/CG option) (Trend, digital, bar graph, and custom displays)”

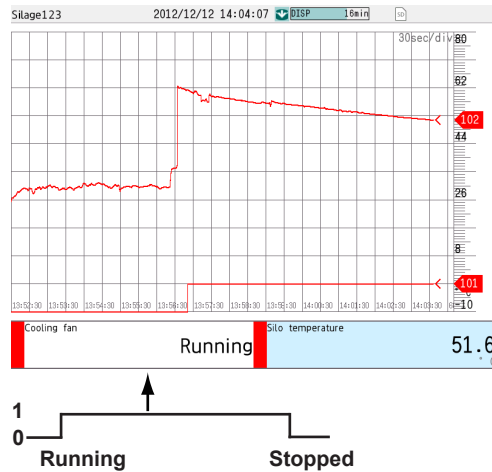



## Explanation

## Common Display Items

## Screen Configuration

The screen consists of the status display section and the data display section.

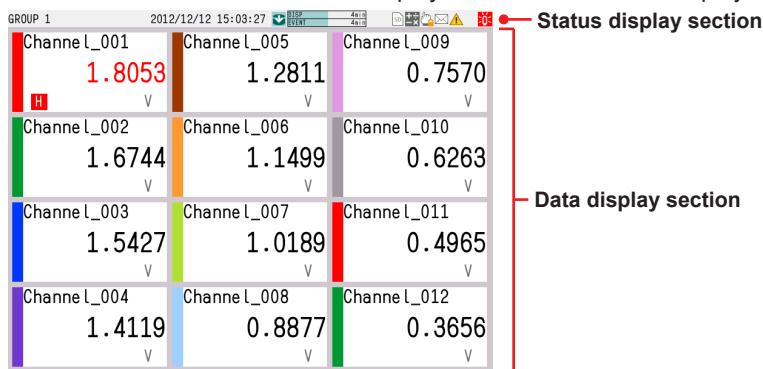

- **Status Display Section**

The status display section shows the display name, date/time, batch name (when using the batch function), user name (when using the login function), usage of the internal memory or SD memory card, alarm occurrence, computation status (/MT option), and usage of operation lock or e-mail transmission.

- **Data Display Section**

The data display section shows the measured data using waveforms, numeric values, and bar graphs.

**Group Display**

On the trend, digital, and bar graph displays, the data of channels is displayed in groups that are set in advance.

Groups are shared among the trend, digital, and bar graph displays.

The displayed group can be switched automatically at a specified time interval (5 s to 1 min).

Number of Groups That Can Be Registered

GX20-1/GP20-1: 50 groups

GX20-2/GP20-2: 60 groups

GX10/GP10: 30 groups

Number of Channels That Can Be Assigned to a Group

GX20/GP20: Up to 20

GX10/GP10: Up to 10

**Update Interval of Measured Values**

Values are updated every 0.5 seconds. However, if the scan interval is greater than 1 s, values are updated at the scan interval.

**Alarm Indication**

Alarms that are set for each channel are checked at all times and are indicated with the symbol representing the alarm type on each display.

Alarm Type	Symbol	Alarm Type	Symbol
High limit alarm	H	High limit on rate-of-change alarm	R
Low limit alarm	L	Low limit on rate-of-change alarm	r
Difference high limit alarm	h	Delay high limit alarm	T
Difference low limit alarm	l (lowercase L)	Delay low limit alarm	t

## 1.2 Configuring AI Channels (Analog (including DI) input) channels and AI (mA) channels

### Status Display Section

The status display section shows the following information (display update interval: 1 s).

**Data type**  
 DISP (D): Display data  
 EVENT (E): Event data  
 EVENT1 (E1): Event data (measurement group 1)  
 EVENT2 (E2): Event data (measurement group 2)  
 Items of GX10/GP10 in parentheses

**Recording stopped**

**Recording in progress**

**Recording status icon**

**Recording progress**  
 Displays the progress using a green bar graph. The frame indicates the file save interval (display data) or the data length (event data).

**DISP** Error in internal memory. Contact your YOKOGAWA dealer for repairs.

**DISP** Displays the remaining recording time for the left bar graph.

**Date and time**  
 2012/12/12 19:44:01

**Display name or group name**  
 GROUP 1

**When using the batch function**  
 BatchName01234567890123456789012-000001 2012/12/12 10:14:07  
 GROUP 1

**When using the login function**  
 UserName012345678901 2012/12/12 10:17:54  
 GROUP 1

**When using the login and batch functions**  
 BatchName01234567890123456789012-0000022012/12/12 10:18:44  
 UserName012345678901 GROUP 1

**Alarm icon**  
 Displayed when any alarm is activated.  
 Blinks when there are alarms that are occurring but have not been acknowledged.  
 All alarms have been released after they have occurred, but there are alarms that have not been acknowledged.

**Status icon**  
 The condition assigned to instrument information output is occurring.  
 Operation lock is enabled.  
 E-mail transmission is enabled.  
 A user has been invalidated (for the /AS option).<sup>1</sup>  
 1 When all administrators have been invalidated:

**Math icon (/MT option)**  
 Gray icon: Computation started  
 Yellow icon: Computation data dropout occurred

**SD memory card icon**  
 Remaining memory space 50% or more  
 Remaining memory space 50% or less  
 Remaining memory space 10% or less  
 External memory error

Recording Status Icons When the Program Control Function (/PG option) Is Enabled

Recording status	Program operation status	Icon
Stopped	Stopped	
Recording	Stopped	
Stopped	Running	
Recording	Running	

## 1.2 Configuring AI Channels (Analog (including DI) input) channels and AI (mA) channels

### Bar Graph

If pre-trigger is specified for event data recording, the GX/GP will start recording pre-trigger data when recording is started and the GX/GP enters the trigger-wait state. "Waiting" appears in the bar graph. At this time, the progress bar turns orange. When the pre-trigger time elapses, the length of the bar is fixed at that point. However, the pre-trigger data is continuously updated in the background until the trigger condition is met. When the trigger condition is met, the bar turns green, and data is recorded after the data in the pre-trigger section.

### Trend Display (T-Y)

Measured data is displayed in a waveform.

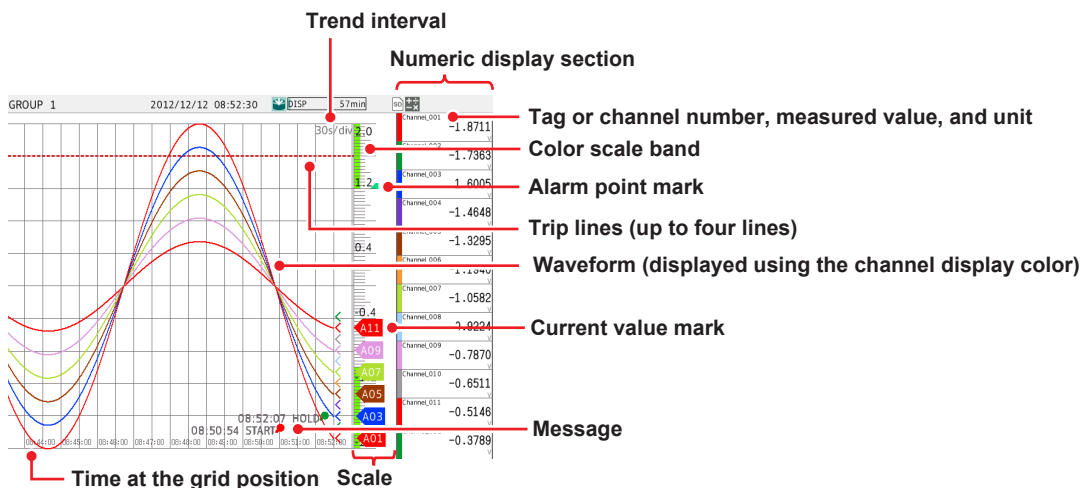

### Alarm Indication

Alarm mark, alarm type, and measured value are displayed as follows depending on the alarm status. They are shared with the digital and bar graph displays.

Alarm	When indication is set to non-hold				When indication is set to hold							
	Occurrence	Release	Alarm ACK	Alarm ACK	Alarm ACK	Alarm ACK	Alarm ACK	Alarm ACK	Alarm ACK	Alarm ACK	Alarm ACK	Alarm ACK
Alarm icon	None	Red	None	None	Blinking red,brown	Blinking gray	None	None	Blinking red,brown	Red	None	None
Alarm mark (type)	None	Red	None	None	Blinking red,brown	Blinking gray	None	None	Blinking red,brown	Red	None	None
Measured value	Black	Red	Black	Black	Red	Black	Black	Black	Red	Red	Black	Black

### Digital Display

The digital display shows measured data using large numbers.

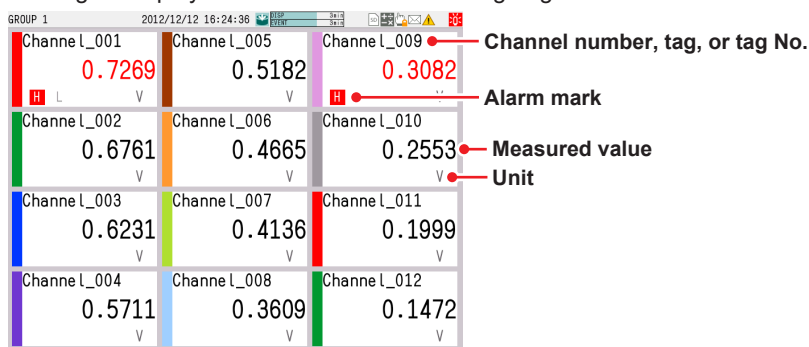

## 1.2 Configuring AI Channels (Analog (including DI) input) channels and AI (mA) channels

### Note

- Numeric display of analog input channels  
If a measured value of an analog input channel is over range (see below), the measured value is indicated as "+Over" or "-Over." If a burnout is detected on a channel whose burnout detection function is enabled, the word "Burnout" is indicated. For all other cases, a numeric value is displayed.

#### Over range of analog input channels

- An over range occurs when the measured value of an analog input channel exceeds  $\pm 5\%$  of the measurable range. For example, the measurable range when the measurement range is 2 V is  $-2.000$  to  $2.000$  V. If the measured value exceeds  $2.200$  V, +over range occurs; if the measured value falls below  $-2.200$  V, -over range occurs.
- For a channel using Linear scaling or Square root, over range occurs if the measured value falls outside the  $-5\%$  to  $105\%$  range of the specified span. You can also change the setting so that over range occurs when the measured value falls outside the  $-5\%$  to  $105\%$  range of the measurable span range. However, +over range occurs if the value excluding the decimal point exceeds 999999 and -over range if it falls below  $-999999$ .

► Setup: See page 1-120 in section 1.11.2, "Setting the Over-range Detection Method".

### Bar Graph Display

Measured data is displayed in a bar graph.

#### Vertical

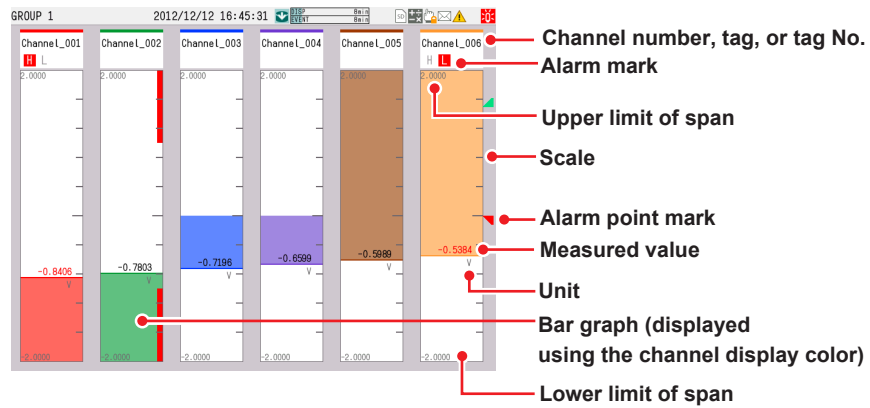

#### Horizontal

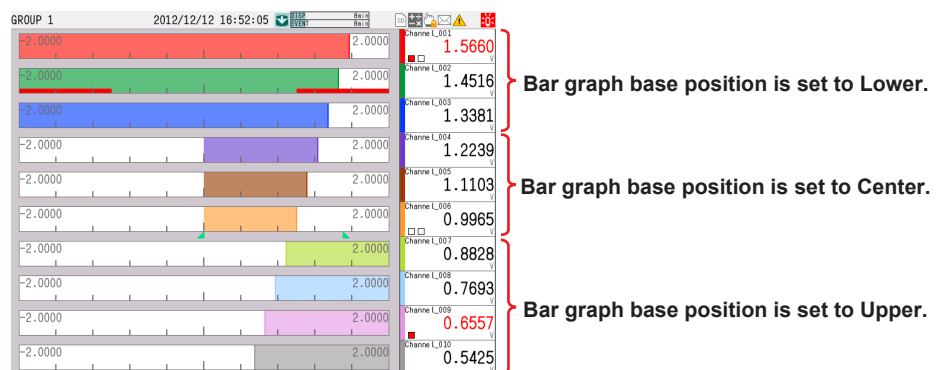

- Bar Graph Updating**

The bar graph is updated at the same interval as numeric values.

## 1.2.4 Setting Calibration Correction (Linearizer approximation, linearizer bias, Correction Factor <sup>1</sup> (release number 3 and later))

<sup>1</sup> Only for the /AH option

### Path

GX/GP: **MENU** key > **Browse** tab > **Setting** > Setting menu **AI channel settings** or **AI (mA) channel settings** > **Calibration correction**

Web application: **Config.** tab > **AI channel settings** or **AI (mA) channel settings** > **Channel range** (display example: 0001-0010) > **Calibration correction**

Hardware configurator: **AI channel settings** or **AI (mA) channel settings** > **Channel range** (display example: 0001-0010) > **Calibration correction**

### Description

Setup Item	Selectable Range or Options	Default Value
First-CH	AI channel	—
Last-CH	AI channel	—

### First-CH, Last-CH

Set the target channels. You can set consecutive channels whose range is set to the same value as the first channel.

### Mode

Setup Item	Selectable Range or Options	Default Value
Mode	Off, Linearizer Approximation, Linearizer Bias, Correction Factor	Off
Number of set points <sup>1</sup>	2 to 12	2

<sup>1</sup> Appears when the mode is not set to **Off**.

### Mode

Set the correction mode when performing calibration correction. When the range is set to DI or Skip, the mode is fixed to Off.

### Number of set points

Set the number of points that make up the segments (including the start and end points).

### 1 to 12 (When the mode is set to linearizer approximation or linearizer bias) <sup>1</sup>

Setup Item	Selectable Range or Options	Default Value
Linearizer input	–999999 to 999999	—
Linearizer output	–999999 to 999999	—
Execution of the input measurement	—	—

<sup>1</sup> The number of displayed points varies depending on the number of set points.

### Linearizer input, Linearizer output

Enter the value of the set point. For linearizer input, set a value that is greater than the previous value.

### Selectable Range of Linearizer Input and Output Values

- Channels using linear scaling  
–999999 to 999999 (the decimal place is the same as that for the scale value)
- Other channels  
Values inside parentheses are examples for the 2 V range.

#### Linearizer approximation

Selectable range of linearizer input: Measurable range (–2.0000 to 2.0000 V)

Selectable range of linearizer output: Display range (–2.2000 to 2.2000 V)

#### Linearizer bias

Selectable range of linearizer input: Measurable range (–2.0000 to 2.0000 V)

Selectable range of linearizer output: Measurement span width  $\pm 100\%$  (–4.0000 to 4.0000 V)

## 1.2 Configuring AI Channels (Analog (including DI) input) channels and AI (mA) channels

### Execution of the Input Measurement (Release number 2 and later)

The linearizer input value is set to the current measured value.

### 1 to 12 (When the mode is set to correction factor) (only for the / AH option)<sup>1</sup>

Setup Item	Selectable Range or Options	Default Value
Uncorrected value	-999999 to 999999	—
Instrument correction factor	-999999 to 999999	—
Sensor correction factor	-999999 to 999999	—
Execution of the input measurement	—	—

1 The number of displayed points varies depending on the number of set points.

#### Uncorrected value

Enter the uncorrected value. Set a value that is greater than the previous value.

- Channels using linear scaling or square root computation  
–999999 to 999999 (the decimal place is the same as that for the scale value)
- Other channels  
Values inside parentheses are examples for the 2 V range.  
Measurable range (–2.0000 to 2.0000 V)

#### Instrument correction factor

Set the instrument-dependent correction factor.

- Channels using linear scaling  
–999999 to 999999 (the decimal place is the same as that for the scale value)  
However, the sum of this factor with the sensor correction factor must not exceed this range.  
Example:  
If the instrument correction factor 12 is set to 999999, the selectable range for sensor correction factor 12 is –999999 to 0.
- Other channels  
Values inside parentheses are examples for the 2 V range.  
Measurement span width  $\pm 100\%$  (–4.0000 to 4.0000 V)  
However, the sum of this factor with the sensor correction factor must not exceed this range.

#### Sensor correction factor

Set the sensor-dependent correction factor.

- Channels using linear scaling  
–999999 to 999999 (the decimal place is the same as that for the scale value)  
However, the sum of this factor with the instrument correction factor must not exceed this range.
- Other channels  
Values inside parentheses are examples for the 2 V range.  
Measurement span width  $\pm 100\%$  (–4.0000 to 4.0000 V)  
However, the sum of this factor with the instrument correction factor must not exceed this range.

### Execution of the Input Measurement (Release number 3 and later)

The uncorrected value is set to the current measured value.

**Procedure**

**Linearizer input, Linearizer output**

Tapping **Execution of the input measurement** displays a confirmation screen. Tap **OK** to set the linearizer input value to the current measured value.

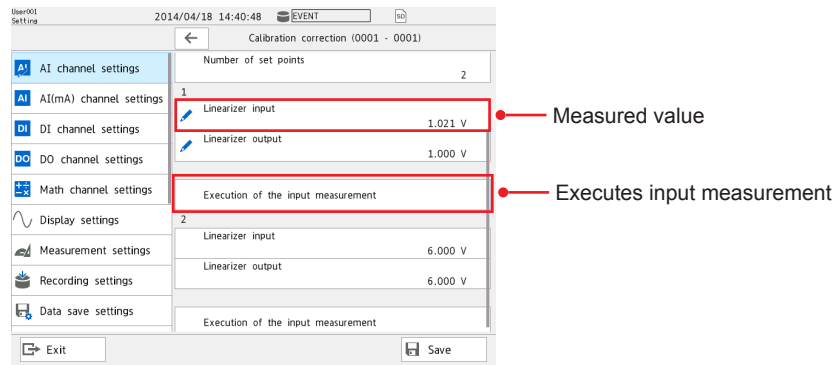

**Correction factor**

Tapping **Execution of the input measurement** displays a confirmation screen. Tap **OK** to set the uncorrected value to the current measured value.

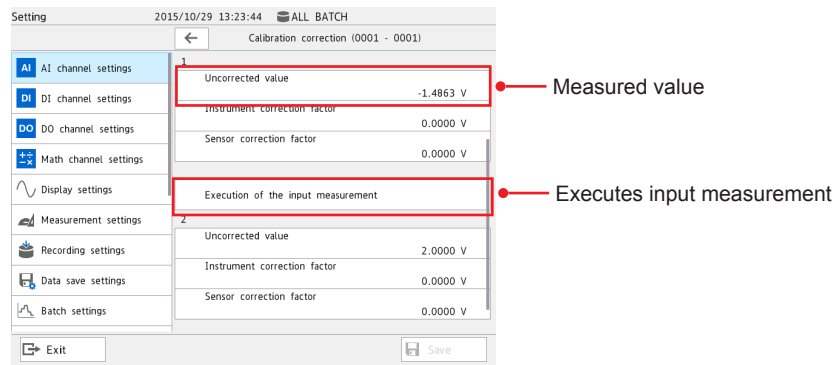

**Note**

- If you change the **Mode** or **Range** setting, the calibration correction setting is set to Off.
- Calibration correction cannot be specified on channels set to **Skip** or **DI**.

**Explanation**

**Linearizer Approximation**

Corrects input values using characteristics specified with segments to derive output values.

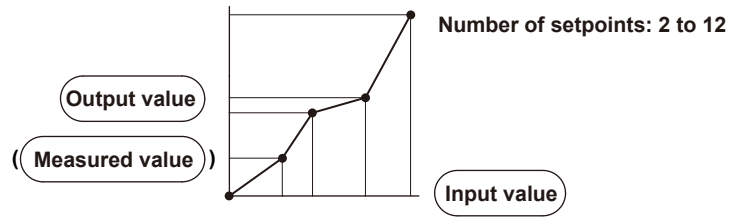

**Linearizer Bias**

Corrects input values using bias values specified with segments to derive output values.

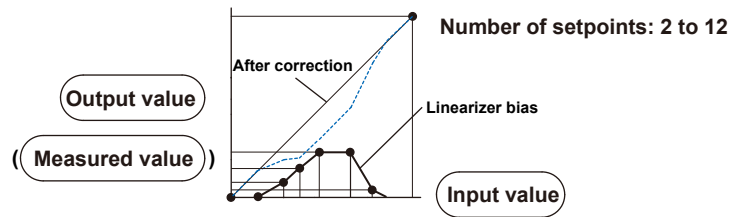

**Correction Factor**

Corrects input values using the instrument correction factor and sensor correction factor specified with segments to derive output values.

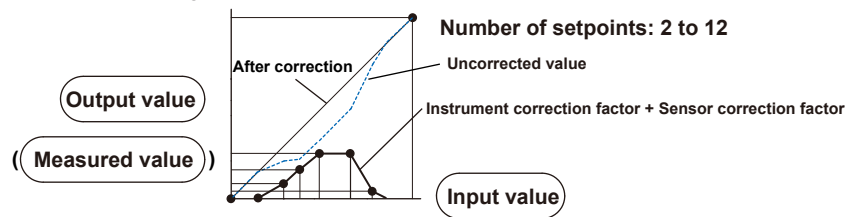



## 1.3 Configuring DI Channels (Digital input channels)

Set the input range, alarm, and display conditions of DI channels (including the DI channels of DI/DO modules).

To use the DI module as a remote control input, set the operation mode of the module to Remote. ► Refer to page 1-120 in section 1.11.3, “Setting the Operation Mode of a Module”. Set the remote control action using event action. ► Refer to page 1-162 in section 1.19, “Configuring the Event Action Function”.

### 1.3.1 Setting the Range

#### Path

GX/GP: **MENU** key > **Browse** tab > **Setting** > Setting menu **DI channel settings** > **Range**

Web application: **Config.** tab > **DI channel settings** > **Channel range** (display example: 0501-0516) > **Range**

Hardware configurator: **DI channel settings** > Channel range (display example: 0501-0516) > **Range**

#### Description

Setup Item	Selectable Range or Options	Default Value
First-CH	DI channel	—
Last-CH	DI channel	—

#### First-CH, Last-CH

Set the target channels. The channels that you can specify appear depending on the module configuration.

#### Range

Setup Item	Selectable Range or Options	Default Value
Type	Skip, DI, Pulse <sup>2</sup>	DI
Span Lower	DI	0, 1
		Delta: -1 to 1
Span Upper	Pulse	0 to 999999 (decimal place: 0)
	DI	0, 1
		Delta: -1 to 1
	Pulse	0 to 999999 (decimal place: 0)
Calculation	Off <sup>3</sup> , Delta, Linear scaling	Off
Reference channel <sup>1</sup>	Value (I/O channel)	—

1 Appears when Calculation is set to **Delta**.

2 You can set this when the GM10 has the /MT option and the operation mode is set to Normal.

3 This is fixed to Off when the Type is set to Pulse.

#### Type

Set the input type.

Options	Description
Skip	Not measured.
DI	Displays contact input or voltage input signals by mapping them to 0% or 100% of the display range.
Pulse	Counts pulses.
	Maximum measurement pulse cycle: 250 Hz (chattering filter for pulse input: off) 125 Hz (chattering filter for pulse input: on)

► For details on the chattering filter for pulse input, see page 1-124 in section 1.11.7, “Setting the Chattering Filter (DI module) for Pulse Input”.

#### Span Lower, Span Upper

Set the input range.

## 1.3 Configuring DI Channels (Digital input channels)

### Calculation

When performing input calculation, set the calculation type. You can set this when the range type is set to **DI**.

- ▶ For details on the input calculation function, see page 1-27 in section 1.2.1, "Setting the Range".

### Reference channel

Set the reference channel for the difference calculation.  
You cannot specify a channel of an AO module.

### Scale<sup>1</sup>

Setup Item	Selectable Range or Options	Default Value
Decimal place	0, 1, 2, 3, 4, 5	2
Scale Lower	-999999 to 999999	0.00
Scale Upper	-999999 to 999999	100.00
Unit	Character string (up to 6 characters, <b>Ala#1</b> )	—

<sup>1</sup> Appears when Calculation is set to **Linear scaling**.

### Decimal place

Set the decimal place of the scale for linear scaling.

### Scale Lower, Scale Upper

Assign values to the results of unit conversion of linear scaling.

### Unit

Set the unit.

### Note

If chattering filter for pulse input is set to On when the range type is set to Pulse, the filter may not operate properly. As such, update the version of the DI module or DI/DO module to R1.04.01 or later. ▶ See page 5-21 in section 5.1.8, "Updating the Firmware (Release number 2 and later)"

## 1.3.2 Setting Alarms

### Path

GX/GP: **MENU** key > **Browse** tab > **Setting** > Setting menu **DI channel settings** > **Alarm**  
Web application: **Config.** tab > **DI channel settings** > **Channel range** (display example: 0501-0516) > **Alarm**  
Hardware configurator: **DI channel settings** > Channel range (display example: 0501-0516) > **Alarm**

### Description

Setup Item	Selectable Range or Options	Default Value
First-CH	DI channel	—
Last-CH	DI channel	—

### First-CH, Last-CH

Set the target channels. The channels that you can specify appear depending on the module configuration.

**Level 1, Level 2, Level 3, Level 4**

Setup Item	Selectable Range or Options	Default Value
On/Off	Off, On	Off
Type <sup>1</sup>	H: High limit, L: Low limit, R: High limit on rate-of-change, r: Low limit on rate-of-change, T: Delay high limit, t: Delay low limit, h: Difference high limit, <sup>2</sup> l: Difference low limit <sup>2</sup>	Off
Value <sup>1</sup>	Within the setting range	0
Hysteresis <sup>1, 4</sup>	0 (fixed)	0
Logging <sup>1</sup>	Off, On	On
Output type <sup>1</sup>	Off, Relay, Internal switch	Off
Output No. <sup>3</sup>	DO channel or internal switch number	—

- 1 Appears when Level (1 to 4) is set to **On**.
- 2 Appears when Calculation of the range setting is set to **Delta**.
- 3 Appears when Output No. is not set to **Off**.
- 4 Appears when the type is set to high limit, low limit, difference high limit, or difference low limit.

**On/Off**

To use an alarm level (1 to 4), set this to **On**.

**Type**

Set the alarm type.

► For details, see page 1-35 in section 1.2.2, “Setting Alarms”.

Alarms of channels set to difference calculation are set in the position shown in the figure below.

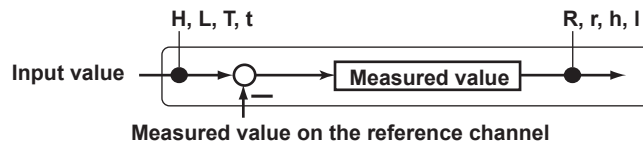
**Value**

Set the alarm value for the specified alarm type.

► For details, see page 1-35 in section 1.2.2, “Setting Alarms”.

**Hysteresis**

Fixed to 0.

**Logging**

Set this **On** to display an alarm (notify you) when an alarm occurs. If set to **Off**, when an alarm occurs, the GX/GP outputs signals to alarm output DO channels or internal switches but does not display the alarm. Alarms are also not recorded in the alarm summary.

**Output type**

Set the alarm output destination.

**Output No.**

Set the number of the DO channel or internal switch to output alarms to.

## 1.3 Configuring DI Channels (Digital input channels)

### Alarm delay (for delay high/low limit alarms)

Setup Item	Selectable Range or Options	Default Value
Hour	1 to 24	0
Minute	0 to 59	0
Second	0 to 59	10

#### Hour, Minute, and Second

Set the alarm delay. These values are valid when the delay high limit or delay low limit is in use.

### 1.3.3 Setting the Display

#### Path

GX/GP: **MENU** key > **Browse** tab > **Setting** > Setting menu **DI channel settings** > **Display settings**

Web application: **Config.** tab > **DI channel settings** > **Channel range** (display example: 0501-0516) > **Display settings**

Hardware configurator: **DI channel settings** > Channel range (display example: 0501-0516) > **Display settings**

#### Description

Setup Item	Selectable Range or Options	Default Value
First-CH	DI channel	—
Last-CH	DI channel	—

#### First-CH, Last-CH

Set the target channels. The channels that you can specify appear depending on the module configuration.

#### Tag

Setup Item	Selectable Range or Options	Default Value
Characters	Character string (up to 32 characters, <b>Aa#1</b> )	—
No.	Character string (up to 16 characters, <b>Aa#1</b> )	—

#### Characters

Set the tag.

Not all characters may be displayed due to space constraints.

#### No.

Set the tag number.

#### Color

Setup Item	Selectable Range or Options	Default Value
Color	24 colors (red, green, blue, blue violet, brown, orange, yellow-green, light blue, violet, gray, lime, cyan, dark blue, yellow, light gray, purple, black, pink, light brown, light green, dark gray, olive, dark cyan, and spring green) and a user-defined color (1 color)	—

#### Color

Set channel display colors. The colors apply to the trend display and bar graph display.

- For instructions on how to set the user-defined color, see page 1-40 in section 1.2.3, “Setting the Display”.

## Zone

Setup Item	Selectable Range or Options	Default Value
Lower	0 to 95%	0
Upper	5 to 100%	100

### Lower, Upper

Set these values when you want to divide the waveform displays of channels into separate zones so that waveforms do not overlap. Set the **Lower** and **Upper** positions as percentages of the maximum display width. Set **Lower** to a value less than **Upper**, and set the zone width (**Upper – Lower**) to be 5% or greater.

## Scale

Setup Item	Selectable Range or Options	Default Value
Position	GX20, GP20: Off, 1, 2, 3, 4, 5, 6, 7, 8, 9, 10 GX10, GP10: Off, 1, 2, 3, 4, 5, 6	1
Division <sup>1</sup>	4, 5, 6, 7, 8, 9, 10, 11, 12, C10	10

<sup>1</sup> Appears when the Rage Type is set to **Pulse**.

### Position

Set this to set the scale display position of the trend display. Set this to **Off** to not display scales.

### Division

Set the number of divisions to make with the main scale marks.

C10: The scale is equally divided into 10 sections by main scale marks, and scale values are indicated at 0, 30, 50, 70, and 100% positions.

- For display examples, see the scale settings on page 1-40 in section 1.2.3, “Setting the Display”.

## Bar graph

Setup Item	Selectable Range or Options	Default Value
Base position	Lower, Center, Upper	Lower
Division <sup>1</sup>	4, 5, 6, 7, 8, 9, 10, 11, 12	10

<sup>1</sup> Appears when the Rage Type is set to **Pulse**.

### Base position

Set the bar graph base position. This setting is applied on the bar graph display and when you are displaying the current value on the scale as a bar graph on the trend displays.

### Division

Set the number of divisions to make with the main scale marks.

- For display examples, see the bar graph settings on page 1-40 in section 1.2.3, “Setting the Display”.

### 1.3 Configuring DI Channels (Digital input channels)

#### Alarm point mark



Setup Item	Selectable Range or Options	Default Value
Indicate on Scale	Off, On	On
Mark kind	Alarm, Fixed	Alarm
Alarm 1 color to Alarm 4 color <sup>1</sup>	24 colors (red, green, blue, blue violet, brown, orange, yellow-green, light blue, violet, gray, lime, cyan, dark blue, yellow, light gray, purple, black, pink, light brown, light green, dark gray, olive, dark cyan, and spring green) and a user-defined color (1 color)	—

<sup>1</sup> Appears when the Mark kind is set to **Fixed**.

#### Indicate on Scale

Set this to **On** to display alarm point marks on the scale. Set this to **Off** to not display them. This setting is shared with the bar graph display.

#### Mark kind

Options	Description	Mark Shape
Alarm	Displayed normally in green. Displayed in the specified color when an alarm occurs.	 or 
Fixed	Displayed with a fixed color.	

#### Alarm 1 color to Alarm 4 color

When Mark kind is set to **Fixed**, set the display colors of point marks for alarm levels 1 to 4.

#### Display characters of each value<sup>1</sup>

Setup Item	Selectable Range or Options	Default Value
0	Character string (up to 8 characters, <b>Aa#1</b> )	—
1	Character string (up to 8 characters, <b>Aa#1</b> )	—

<sup>1</sup> Appears when Calculation is set to **Off**.

#### 0

Set the character string to display when the measured value is 0.

#### 1

Set the character string to display when the measured value is 1.

► For usage examples, see page 1-40 in section 1.2.3, “Setting the Display”.

## 1.4 Configuring Pulse Input Channels (Release number 3 and later)

Set the input range, alarm, and display conditions of pulse input channels and display conditions.

To perform pulse input integration, the computation (/MT) option is required.

- ▶ For details on computation, see page 1-83 in section 1.8, "Configuring Math Channels (/MT option)".
- ▶ For computation examples, see page App-29 in section Appendix 7, "Computation Examples Using Pulse Input".

### 1.4.1 Setting the Range

#### Path

GX/GP: **MENU** key > **Browse** tab > **Setting** > Setting menu **Pulse input channel settings** > **Range**

Web application: **Config.** tab > **Pulse input channel settings** > **Channel range** (display example: 0701-0710) > **Range**

Hardware configurator: **Pulse input channel settings** > Channel range (display example: 0701-0710) > **Range**

#### Description

Setup Item	Selectable Range or Options	Default Value
First-CH	Pulse input channel	—
Last-CH	Pulse input channel	—

#### First-CH, Last-CH

Set the target channels. The channels that you can specify appear depending on the module configuration.

#### Range

Setup Item	Selectable Range or Options	Default Value
Type	Skip, Pulse	Pulse
Range	Level, Contact	Level
Chattering filter	Off, On	On
Span Lower	0 to 200000 Delta: -200000 to 200000	0
Span Upper	0 to 200000 Delta: -200000 to 200000	200000
Calculation	Off, Delta, Linear scaling	Off
Reference channel <sup>1</sup>	Number (I/O channel number)	—

<sup>1</sup> Appears when Calculation is set to **Delta**.

#### Type

Set the input type.

Options	Description
Skip	Not measured.
Pulse	Counts pulses

#### Range

Set the pulse input range.

Options	Description
Level	Voltage input (counted when a change from 1 V or lower to 3 V or higher is detected)
Contact	Contact input (counted when a change from 100 kΩ or higher to 200 Ω or lower is detected)

#### Chattering filter

This filter prevents pulse count errors caused by chattering or noise.

Options	Description
Off	The chattering filter is not used.
On	The chattering filter is used.

## 1.4 Configuring Pulse Input Channels (Release number 3 and later)

### Note

When the chattering filter is set to On, the input range can be up to 30 Hz.

### Span Lower, Span Upper

Set the input range. You cannot set the same value to Span Lower and Span Upper.

- When Calculation is set to **Off** or **Linear scaling**.  
0 to 200000
- When Calculation is set to **Delta**.  
-200000 to 200000

**Example: Measured value per scan interval when 10000 (pulse/s) is input**

Scan interval	100 ms	200 ms	500 ms	1 s	2 s	5 s
Measured value	1000	2000	5000	10000	20000	50000

### Calculation

When performing input calculation, set the calculation type.

► For details, see page 1-27 in section 1.2.1, "Setting the Range".

- **Linear scaling**

Converts the unit to obtain the measured value.

- **Delta**

The measured value of the channel is set to the difference with respect to the measured value of the reference channel.

### Reference Channel

Set the reference channel for the difference calculation.

► For details, see page 1-27 in section 1.2.1, "Setting the Range".

### Scale <sup>1</sup>

Setup Item	Selectable Range or Options	Default Value
Decimal place	0/1/2/3/4/5	2
Scale Lower	-999999 to 999999	0.00
Scale Upper	-999999 to 999999	100.00
Unit	Character string (up to 6 characters, $\boxed{A a \# 1}$ )	—

<sup>1</sup> Appears when Calculation is set to **Linear scaling**.

► See page 1-27 in section 1.2.1, "Setting the Range".

### Moving average

Setup Item	Selectable Range or Options	Default Value
On/Off	Off, On	Off
Count <sup>1</sup>	2 to 100	2

<sup>1</sup> Appears when On/Off is set to **On**.

► See page 1-27 in section 1.2.1, "Setting the Range".

### Note

If you change the GX/GP's date or time or when the time is being gradually adjusted, the scan interval will change. This will change the measured values of each scan interval, but it will not affect the integration result (TLOG.PSUM). The default span upper and span lower limits assume values that are affected the most by a time change at the scan interval of 5 s.



## 1.4.2 Setting Alarms

### Path

GX/GP: **MENU** key > **Browse** tab > **Setting** > Setting menu **Pulse input channel settings** > **Alarm**

Web application: **Config.** tab > **Pulse input channel settings** > **Channel range** (display example: 0701-0710) > **Alarm**

Hardware configurator: **Pulse input channel settings** > **Channel range** (display example: 0701-0710) > **Alarm**

### Description

Setup Item	Selectable Range or Options	Default Value
First-CH	Pulse input channel	—
Last-CH	Pulse input channel	—

### First-CH, Last-CH

Set the target channels. The channels that you can specify appear depending on the module configuration.

### Level 1, Level 2, Level 3, Level 4

Setup Item	Selectable Range or Options	Default Value
On/Off	Off, On	Off
Type <sup>1</sup>	H: High limit, L: Low limit, R: High limit on rate-of-change, r: Low limit on rate-of-change, T: Delay high limit, t: Delay low limit, h: Difference high limit, <sup>2</sup> l: Difference low limit <sup>2</sup>	Off
Alarm value <sup>1</sup>	Within the setting range	0
Hysteresis <sup>1, 4</sup>	Numeric value When Calculation is set to <b>Off</b> or <b>Delta</b> : 0 to 5% of range setting When math is set to <b>Linear scaling</b> : 0 to 100000	5
Logging <sup>1</sup>	Off, On	On
Output type <sup>1</sup>	Off, Relay, Internal switch	Off
Output No. <sup>3</sup>	DO channel or internal switch number	—

1 Appears when Level (1 to 4) is set to **On**.

2 Appears when Calculation of the range setting is set to **Delta**.

3 Appears when Output No. is not set to **Off**.

4 Appears when the type is set to high limit, low limit, difference high limit, or difference low limit.

### On/Off

To use an alarm level (1 to 4), set this to **On**.

### Type

Set the alarm type.

► For details, see page 1-35 in section 1.2.2, "Setting Alarms".

Alarms of channels set to difference calculation are set in the position shown in the figure below.

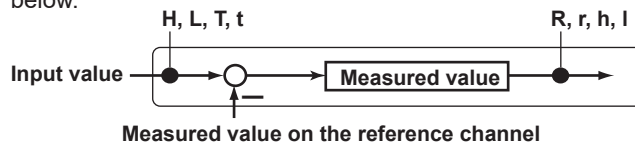

### Value

Set the alarm value for the specified alarm type.

► For details, see page 1-35 in section 1.2.2, "Setting Alarms".

### Hysteresis

Set this to establish an offset between the value used to activate and release alarms.

## 1.4 Configuring Pulse Input Channels (Release number 3 and later)

### Logging

Set this **On** to display an alarm (notify you) when an alarm occurs. If set to **Off**, when an alarm occurs, the GM outputs signals to alarm output DO channels or internal switches but does not display the alarm. Alarms are also not recorded in the alarm summary.

### Output type

Set the alarm output destination.

### Output No.

Set the number of the DO channel or internal switch to output alarms to.

### Alarm delay (for delay high/low limit alarms)

Setup Item	Selectable Range or Options	Default Value
Hour	1 to 24	0
Minute	0 to 59	0
Second	0 to 59	10

### Hour, Minute, and Second

Set the alarm delay. These values are valid when the delay high limit or delay low limit is in use.

## 1.4.3 Setting the Display

### Path

GX/GP: **MENU** key > **Browse** tab > **Setting** > Setting menu **Pulse input channel settings** > **Display settings**

Web application: Config. tab > **Pulse input channel settings** > **Channel range** (display example: 0701-0710) > **Display settings**

Hardware configurator: **Pulse input channel settings** > **Channel range** (display example: 0701-0710) > **Display settings**

### Description

Setup Item	Selectable Range or Options	Default Value
First-CH	Pulse input channel	—
Last-CH	Pulse input channel	—

### First-CH, Last-CH

Set the target channels. The channels that you can specify appear depending on the module configuration.

### Tag

Setup Item	Selectable Range or Options	Default Value
Characters	Character string (up to 32 characters, <b>Aa#1</b> )	—
No.	Character string (up to 16 characters, <b>Aa#1</b> )	—

### Characters

Set the tag.

Not all characters may be displayed due to space constraints.

### No.

Set the tag number.

## Color

Setup Item	Selectable Range or Options	Default Value
Color	24 colors (red, green, blue, blue violet, brown, orange, yellow-green, light blue, violet, gray, lime, cyan, dark blue, yellow, light gray, purple, black, pink, light brown, light green, dark gray, olive, dark cyan, and spring green) and a user-defined color (1 color)	—

### Color

Set channel display colors. The colors apply to the trend display and bar graph display.

► For usage examples, see page 1-40 in section 1.2.3, “Setting the Display”.

## Zone

Setup Item	Selectable Range or Options	Default Value
Lower	0 to 95%	0
Upper	5 to 100%	100

### Lower and Upper

Set these values when you want to divide the waveform displays of channels into separate zones so that waveforms do not overlap. Set the Lower and Upper positions as percentages of the maximum display width. Set Lower to a value less than Upper, and set the zone width (Upper – Lower) to be 5% or greater.

## Scale

Setup Item	Selectable Range or Options	Default Value
Position	GX20, GP20: Off, 1, 2, 3, 4, 5, 6, 7, 8, 9, 10	1
GX10/GP10: Off/1/2/3/4/5/6\$3	1	10
Division <sup>1</sup>	4, 5, 6, 7, 8, 9, 10, 11, 12, C10	10

<sup>1</sup> Appears when the type is set to **Pulse**.

### Position

Set this to set the scale display position of the trend display. Set this to **Off** to not display scales.

### Division

Set the number of divisions to make with the main scale marks.

C10: The scale is equally divided into 10 sections by main scale marks, and scale values are indicated at 0, 30, 50, 70, and 100% positions.

► For display examples, see page 1-40 in section 1.2.3, “Setting the Display”.

## Bar graph

Setup Item	Selectable Range or Options	Default Value
Base position	Lower, Center, Upper	Lower
Division <sup>1</sup>	4, 5, 6, 7, 8, 9, 10, 11, 12	10

<sup>1</sup> Appears when the type is set to **Pulse**.

### Base position

Set the bar graph base position. This setting is applied when you are displaying the current value on the scale as a bar graph on the bar graph and trend displays.

### Division

Set the number of divisions to make with the main scale marks.

► For display examples, see page 1-40 in section 1.2.3, “Setting the Display”.

## 1.4 Configuring Pulse Input Channels (Release number 3 and later)

### Partial<sup>1</sup>

Setup Item	Selectable Range or Options	Default Value
On/Off	Off, On	Off
Expand	1 to 99(%)	50%
Boundary	Span lower limit + 1 digit to span upper limit – 1 digit	0

<sup>1</sup> Appears when in the **Display settings** of the setting menu, **Partial On/Off** is set to **On**.

### On/Off

Set this to **On** to enable partial expanded display of waveforms.

► For details on this function, see page 1-114 in section 1.10.4, “Setting Trend Display Conditions”.

### Expand

Set at which position to display the value specified by **Boundary** within the display width. Specify a percentage.

### Boundary

Set the value that is to be the boundary between the reduced section and the expanded section in the range of “minimum span value + 1 digit to maximum span value – 1 digit.” For channels that are set to scaling, the selectable range is “minimum scale value + 1 digit to maximum scale value – 1 digit.”

### Color scale band

Setup Item	Selectable Range or Options	Default Value
Band area	Off, In, Out	Off
Color	24 colors (red, green, blue, blue violet, brown, orange, yellow-green, light blue, violet, gray, lime, cyan, dark blue, yellow, light gray, purple, black, pink, light brown, light green, dark gray, olive, dark cyan, and spring green) and a user-defined color (1 color)	—
Display position Lower	Span (scale) lower limit to span (scale) upper limit	0
Display position Upper	Span (scale) lower limit to span (scale) upper limit	100

### Band area

Displays a specified section of the measurement range using a color band on the scale. This setting is shared with the bar graph display.

Options	Description
Off	Disables the function.
In	Displays the area inside using the color band.
Out	Displays the area outside using the color band.

### Color

Set the display color.

► For instructions on how to set the user-defined color, see page 1-40 in section 1.2.3, “Setting the Display”.

## Alarm point mark



Setup Item	Selectable Range or Options	Default Value
Indicate on Scale	Off, On	On
Mark kind	Alarm, Fixed	Alarm
Alarm 1 color to Alarm 4 color <sup>1</sup>	24 colors (red, green, blue, blue violet, brown, orange, yellow-green, light blue, violet, gray, lime, cyan, dark blue, yellow, light gray, purple, black, pink, light brown, light green, dark gray, olive, dark cyan, and spring green) and a user-defined color (1 color)	—

<sup>1</sup> Appears when the Mark kind is set to **Fixed**.

### Indicate on Scale

Set this to **On** to display alarm point marks on the scale. Set this to **Off** to not display them. This setting is shared with the bar graph display.

### Mark kind

Options	Description	Mark Shape
Alarm	Displayed normally in green. Displayed in the specified color when an alarm occurs.	 or 
Fixed	Displayed with a fixed color.	

### Alarm 1 color to Alarm 4 color

When Mark kind is set to **Fixed**, set the display colors of point marks for alarm levels 1 to 4.

# 1.5 Configuring AO Channels (Analog input channels)

Set the AO channel range and display.

## 1.5.1 Setting the Range

### Path

GX/GP: **MENU** key > **Browse** tab > **Setting** > Setting menu **AO channel settings** > **Range**  
Web application: **Config.** tab > **AO channel settings** > **Channel range** (display example: 0701-0704) > **Range**

Hardware configurator: **AO channel settings** > Channel range (display example: 0701-0704) > **Range**

### Description

Setup Item	Selectable Range or Options	Default Value
First-CH	AO channel	—
Last-CH	AO channel	—

### First-CH, Last-CH

The channel numbers that you can specify appear. Channel numbers vary depending on the module.

### Range

Setup Item	Selectable Range or Options	Default Value
Type	Skip, Re-Trans, Manual	Skip
Range <sup>1</sup>	4-20mA/0-20mA	4-20mA
Span Lower <sup>1</sup>	4.000 to 20.000, 0.000 to 20.000	4.000
Span Upper <sup>1</sup>	4.000 to 20.000, 0.000 to 20.000	20.000

<sup>1</sup> You cannot set this when Type is set to **Skip**.

### Type

Set the output type.

Option	Description
Skip	Nothing is output.
Re-Trans	An analog value corresponding to the span of the specified reference channel is output.
Manual	A specified value is output.

### Range

Set the output range.

### Span Lower, Span Upper

Set the output span. You cannot set the same value to Span Lower and Span Upper.

### Reference channel <sup>1</sup>

Setup Item	Selectable Range or Options	Default Value
Channel type	Input channel, Math channel, Communication channel	Input channel
Channel number	Number (reference channel number)	—

<sup>1</sup> You can set this when the range type is set to Re-Trans.

### Channel type

Set the reference channel type for retransmission output.

### Channel number

Set the reference channel number for retransmission output.

### Preset value

Setup Item	Selectable Range or Options	Default Value
Preset value	0.000 to 22.000	0.000

#### Preset value

Set the preset value when Preset action is set to Preset value.  
The preset value is independent of the span setting. It can be set to any value within the setting range.

### Preset action

Setup Item	Selectable Range or Options	Default Value
At power-on	Preset value, Last value	Preset value
On error	Preset value, Last value	Preset value
Re-trans stop	Preset value, Last value	Preset value

#### At power-on

Zero is output while initialization is in progress at power on.  
After initialization, the previous value or preset value is output until the first output is determined (while measurement is being started).

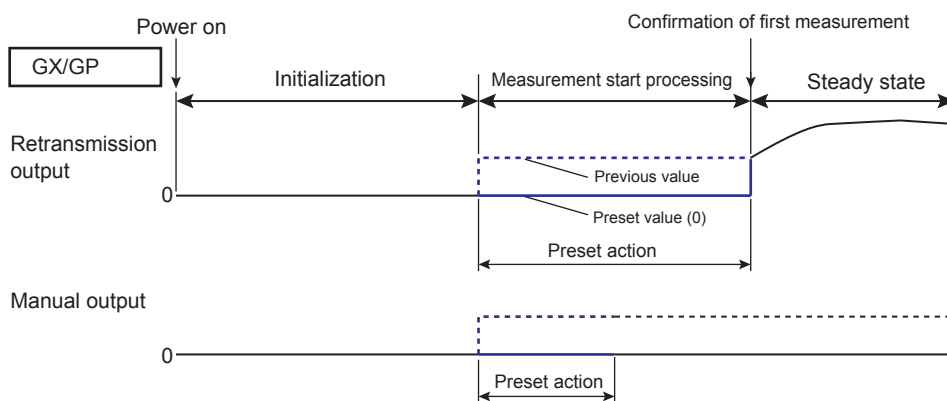

## 1.5 Configuring AO Channels (Analog input channels)

### On error

If the main unit fails or the connection to the expandable I/O is disconnected, the previous value or preset value is output.

Even when the reference channel cannot be measured, the previous value or preset value is output. See the following explanation.

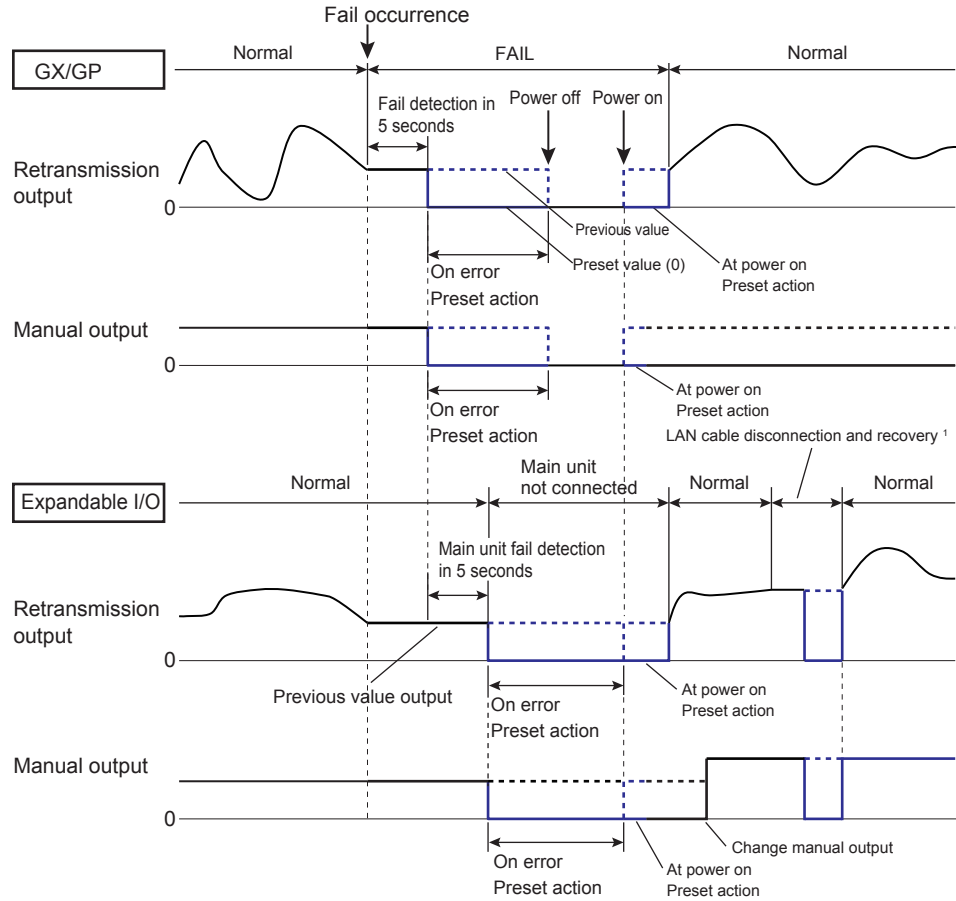

<sup>1</sup> When the LAN cable is disconnected, the previous value is output for 5 seconds. When 5 seconds elapse, preset action on error is performed. If the connection recovers, the output is resumed.

### Re-trans stop

The previous value or preset value is output when the range type is set to retransmission output in the following situations.

This does not work when the range type is set to manual output.

- When computation is stopped if the reference channel is a math channel
- When retransmission output is off



**Description**

**Retransmission Output Operation**

- If the output value is outside +105% to -5% of the reference channel's set span, the output is clipped at the boundaries of this span. (If the output value is outside the 0 to 22 mA range, the output is clipped at the boundaries of this range.)
- If the reference channel is a measurement channel or communication channel, when the reference channel is +OVER, the output is clipped at 105% of the output channel's set span. When the reference channel is -OVER, the output is clipped at -5% of the set span.

**Preset action**

**When the reference channel is a measurement channel**

State	Preset action
When retransmission output is off	Preset action when stopped
When the module has been removed, measurement channel is set to Skip, A/D error, calibration error, burnout	Preset action on error

**When the reference channel is a communication channel**

State	Preset action
When retransmission output is off	Preset action when stopped
When NaN is input, communication channel is off	Preset action on error

**When the reference channel is a math channel**

State	Preset action
When math is stopped	Preset action when stopped
When retransmission output is off	
When the math channel value is +OVER, -OVER, math error, or when the math channel is off	Preset action on error

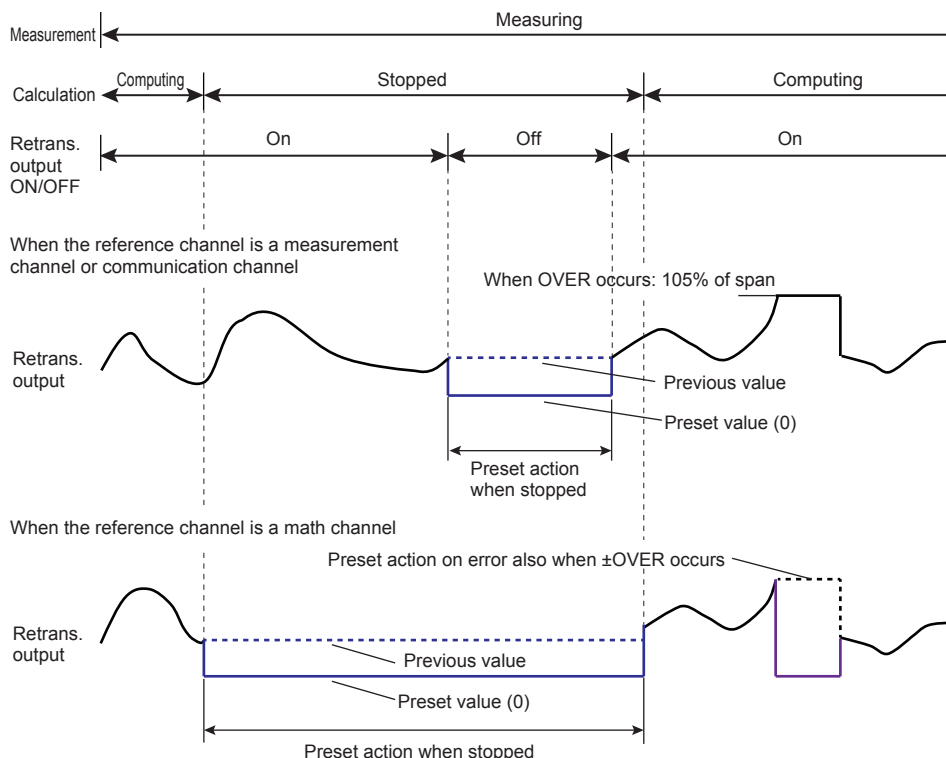

### Output Action When Settings Are Changed

#### Re-Trans

Description of change	Action
<ul style="list-style-type: none"> <li>Reference channel settings, scan interval, module operation mode, A/D integration time, over-range detection, range-over judgment upper and lower limits, chattering filter for pulse input (DI module), and temperature unit</li> <li>* Depending on the type of setting, it may take some time for the measurement to start after changing the setting.</li> </ul>	After the settings are changed, the values before the change are used until the next measurement starts. Then, the new settings are applied.
<ul style="list-style-type: none"> <li>Output channel span</li> </ul>	It is applied to the next measurement after the setting has been changed.
<ul style="list-style-type: none"> <li>Change to manual output</li> </ul>	The value immediately before the setting was changed is held until the next time the manual value is changed.

#### Manual

Description of change	Action
<ul style="list-style-type: none"> <li>Change to retransmission output</li> </ul>	It is applied to the next measurement after the setting has been changed.
<ul style="list-style-type: none"> <li>Preset value during preset output</li> </ul>	It is applied at the next output update interval (100 ms).

## 1.5.2 Setting the Display

### Path

GX/GP: **MENU** key > **Browse** tab > **Setting** > Setting menu **AO channel settings** > **Display settings**

Web application: **Config.** tab > **AO channel settings** > **Channel range** (display example: 0701-0704) > **Display settings**

Hardware configurator: **AO channel settings** > Channel range (display example: 0701-0704) > **Display settings**

### Description

Setup Item	Selectable Range or Options	Default Value
First-CH	AO channel	—
Last-CH	AO channel	—

#### First-CH, Last-CH

The channel numbers that you can specify appear. Channel numbers vary depending on the module.

### Tag

Setup Item	Selectable Range or Options	Default Value
Characters	Character string (up to 32 characters, <input )<="" td="" type="text" value="Aa#1"/> <td>—</td>	—
No.	Character string (up to 16 characters, <input )<="" td="" type="text" value="Aa#1"/> <td>—</td>	—

#### Characters

Set the tag.

Not all characters may be displayed due to space constraints.

#### No.

Set the tag number.

#### Precedence in Displaying Characters and Numbers (GX/GP main unit display only)

Tag numbers are displayed with higher precedence than tag characters.

When tag numbers are not assigned, tag characters are displayed.

If neither the tag numbers or tag characters are assigned, channel numbers are displayed.

## Color

Setup Item	Selectable Range or Options	Default Value
Color	24 colors (red, green, blue, blue violet, brown, orange, yellow-green, light blue, violet, gray, lime, cyan, dark blue, yellow, light gray, purple, black, pink, light brown, light green, dark gray, olive, dark cyan, and spring green) and a user-defined color (1 color)	—

### Color

Set channel display colors. The colors apply to the trend display and bar graph display.

- For instructions on how to set the user-defined color, see page 1-40 in section 1.2.3, “Setting the Display”.

## Zone

Setup Item	Selectable Range or Options	Default Value
Lower	0 to 95%	0
Upper	5 to 100%	100

### Lower and Upper

Set these values when you want to divide the waveform displays of channels into separate zones so that waveforms do not overlap. Set the **Lower** and **Upper** positions as percentages of the maximum display width. Set **Lower** to a value less than **Upper**, and set the zone width (**Upper** – **Lower**) to be 5% or greater.

## Scale

Setup Item	Selectable Range or Options	Default Value
Position	GX20/GP20: Off/1/2/3/4/5/6/7/8/9/10 GX10/GP10: Off/1/2/3/4/5/6	1
Division	4/5/6/7/8/9/10/11/12/C10	10

### Position

Set the scale display positions when you want to display multiple scales on the trend display. Set this to **Off** to not display scales.

### Division

Set the number of divisions to make with the main scale marks.

C10: The scale is equally divided into 10 sections by main scale marks, and scale values are indicated at 0, 30, 50, 70, and 100% positions.

- For display examples, see the scale settings on page 1-40 in section 1.2.3, “Setting the Display”.

## Bar graph

Setup Item	Selectable Range or Options	Default Value
Base position	Lower, Center, Upper	Lower
Division	4/5/6/7/8/9/10/11/12	10

### Base position

Set the bar graph base position. This setting is applied when you are displaying the current value on the scale as a bar graph on the bar graph and trend displays (only on the GX/GP main unit display).

### Division

Set the number of divisions to make with the main scale marks.

- For display examples, see page 1-40 in section 1.2.3, “Setting the Display”.

## 1.6 Configuring DO Channels (Digital output channels)

Set the input range and display conditions of DO channels (including the DO channels of DI/DO modules).

In addition to alarm output, DO output is possible through touch operation (manual operation).

### 1.6.1 Setting the Range

#### Path

GX/GP: **MENU** key > **Browse** tab > **Setting** > Setting menu **DO channel settings** > **Range**  
Web application: **Config.** tab > **DO channel settings** > **Channel range** (display example: 0701-0706) > **Range**

Hardware configurator: **DO channel settings** > Channel range (display example: 0701-0706) > **Range**

#### Description

Setup Item	Selectable Range or Options	Default Value
First-CH	DO channel	—
Last-CH	DO channel	—

#### First-CH, Last-CH

Set the target channels. The channels that you can specify appear depending on the module configuration.

#### Range

Setup Item	Selectable Range or Options	Default Value
Type	Alarm, Manual	Alarm
Span Lower	0, 1	0
Span Upper	0, 1	1
Unit	Character string (up to 6 characters, <b>Aa#1</b> )	—

#### Type

Set the input type.

To output through touch operation (manual operation), “Changing each value from monitoring” must be set to On. ► Refer to page 1-117 in section 1.10.5, “Setting Basic Screen Items”

► For the procedure, see page 2-10 in section 2.2.1, “Displaying Measured Data Using Waveforms, Numeric Values, Bar Graph, or Custom Display (ICG option) (Trend, digital, bar graph, and custom displays)”.

Options	Description
Alarm	Alarm output
Manual	Manual output and event action output

#### Span Lower, Span Upper

Specify 0 or 1. You cannot set the same value to Span Lower and Span Upper.

#### Unit

Set the unit.

**Action**

Setup Item	Selectable Range or Options	Default Value
Energize/De-energize	Energize, De-energize	Energize
Action <sup>1</sup>	And, Or, Reflash	Or
Hold <sup>1, 2</sup>	Hold, Nonhold	Nonhold
Relay action on ACK <sup>1</sup>	Normal, Reset	Normal
Relay deactivated interval <sup>1, 3</sup>	500 ms, 1 s, 2 s	500 ms

- 1 Does not appear when Type is set to **Manual**.
- 2 Does not appear when Action is set to **Reflash**.
- 3 Appears when Action is set to **Reflash**.

**Energize/De-energize**

Set whether to **Energize** or **De-energize** the DO output when an alarm occurs.

**Action**

Options	Description
And	Activated when all assigned alarms are occurring simultaneously.
Or	Activated when any of the specified alarms is occurring.
Reflash	When multiple alarms are assigned to one alarm output relay, the GX/GP notifies the occurrence of subsequent alarms after the relay is activated by the first alarm.

**Hold**

Set the DO channel output operation.

Options	Description
Hold	Holds the output relay at ON until an alarm acknowledge operation is performed.
Nonhold	Turns the output relay off when the alarm condition is released (returns to normal condition).

**Relay action on ACK**

Set what the output state of the DO channel would be after an alarm ACK operation.

If Individual alarm ACK is set **On**, this is set to **Reset**.

Options	Description
Normal	The relay is deactivated when an alarm ACK is executed. If the condition for activating the alarm output relay is met in the next 100 ms, the relay will be activated. This operation is valid only when the alarm output relay is set to <b>Hold</b> .
Reset	The relay is deactivated when an alarm ACK is executed. If the condition for activating the alarm output relay is met again, the relay will be activated.

**Example:**

An example of the relay action when alarm ACK is executed is shown below. In this example, the relay is set to **Or** and **Hold**.

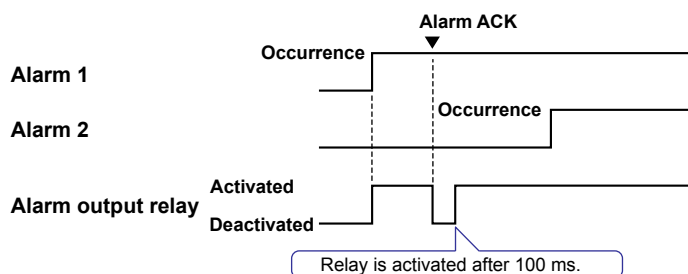
**Normal**

## 1.6 Configuring DO Channels (Digital output channels)

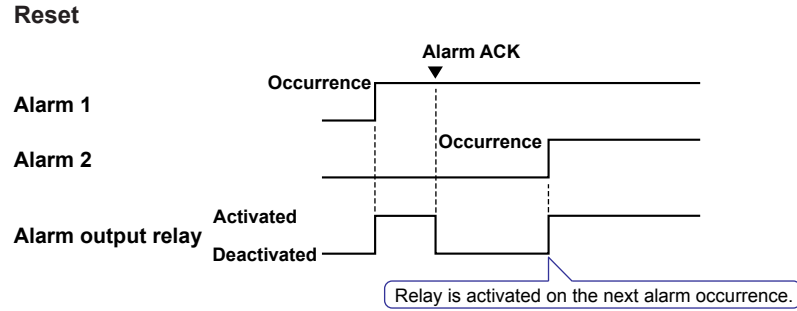

### Relay deactivated interval

Set the relay's not-active interval for reflash operation.

### Explanation

#### AND/OR Operation

When multiple alarms are assigned to one alarm output relay, you can select which condition below will activate the output relay. You can also specify AND operation for internal switches.

- AND: Activated when all assigned alarms are occurring simultaneously
- OR: Activated when any of the specified alarms is occurring

#### Reflash

When multiple alarms are assigned to one alarm output relay, this function notifies the occurrence of subsequent alarms after the relay is activated by the first alarm. When subsequent alarms occur, the output relay is released temporarily. The duration for which the relays are deactivated can be set to 500 ms, 1 s, or 2 s.

Relays set to Reflash will operate using **Or** and **Nonhold** settings.

#### Energize or De-energize Operation

You can select whether the alarm output relay is energized or de-energized when an alarm occurs. If you select de-energize, the alarm output relays will be in the same state when the GX/GP is shut down as they are when an alarm occurs.

#### Nonhold/Hold

The alarm output relay can be set to operate in the following fashion when the alarm condition is no longer met.

- Turn OFF the relay output (nonhold).
- Hold the relay at ON until the alarm ACK is executed (hold).

#### Alarm ACK Operation

##### Acknowledging all Alarms

The alarm acknowledge (alarm ACK) operation releases all alarm indications and relay outputs.

##### Acknowledging Individual Alarms (Release number 2 and later)

Individual alarm ACK operation releases specific alarms.

For the behavior of alarm indication and alarm output relay when you execute an alarm ACK operation, see the next page.

### DO Output Relay Operation

The DO output relay operation is shown below.

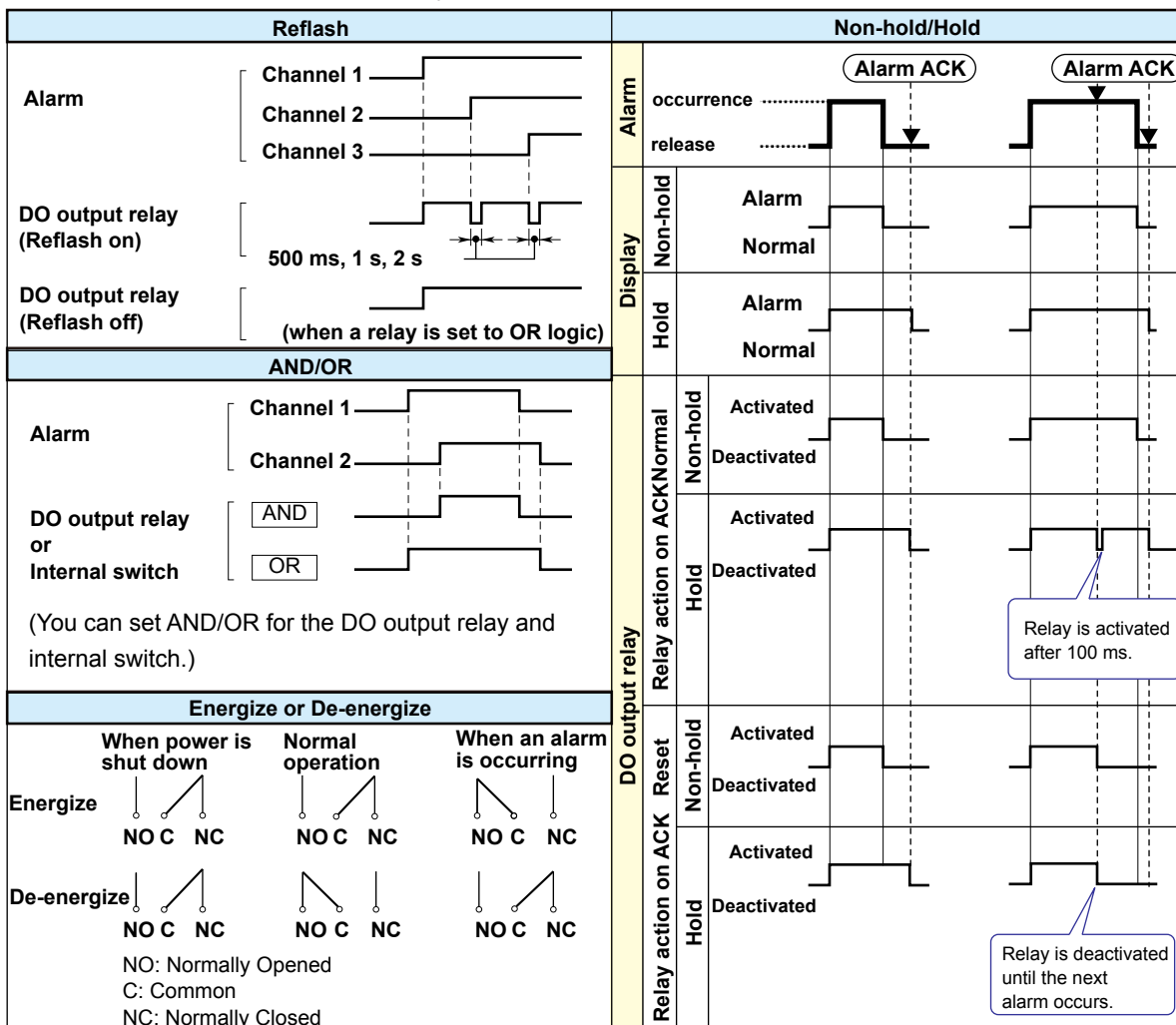

### DO Output Relay Operation during an Error

When an error (FAIL) occurs in the system, the DO output relay is de-energized (as shown below). The DO output relay operation is shown below.



Item	Description
When a CPU error occurs in the GX/GP	The DO output relay of the GX/GP is de-energized. The DO output relays of all expandable I/Os are de-energized.
When a CPU error occurs in an expansion module	The DO output relays of the GX/GP and expandable I/Os in which errors are not occurring continue normal operation. The DO output relay of the expandable I/O in which the error occurred is de-energized.
When a connection between expandable I/Os are disconnected	The DO output relay of the GX/GP continues normal operation. The DO output relays of the expandable I/O that was disconnected and those of subsequent units are de-energized. Normal operation resumes when the connection recovers.

## 1.6.2 Setting the Display

### Path

GX/GP: **MENU** key > **Browse** tab > **Setting** > Setting menu **DO channel settings** > **Display settings**

Web application: **Config.** tab > **DO channel settings** > **Channel range** (display example: 0701-0706) > **Display settings**

Hardware configurator: **DO channel settings** > Channel range (display example: 0701-0706) > **Display settings**

### Description

Setup Item	Selectable Range or Options	Default Value
First-CH	DO channel	—
Last-CH	DO channel	—

#### First-CH, Last-CH

Select the target channels. The channels that you can specify appear depending on the module configuration.

### Tag

Setup Item	Selectable Range or Options	Default Value
Characters	Character string (up to 32 characters, <b>Aa#1</b> )	—
No.	Character string (up to 16 characters, <b>Aa#1</b> )	—

#### Characters

Set the tag.

Not all characters may be displayed due to space constraints.

#### No.

Set the tag number.

### Color

Setup Item	Selectable Range or Options	Default Value
Color	24 colors (red, green, blue, blue violet, brown, orange, yellow-green, light blue, violet, gray, lime, cyan, dark blue, yellow, light gray, purple, black, pink, light brown, light green, dark gray, olive, dark cyan, and spring green) and a user-defined color (1 color)	—

#### Color

Set channel display colors. The colors apply to the trend display and bar graph display.

► For instructions on how to set the user-defined color, see page 1-40 in section 1.2.3, “Setting the Display”.

### Zone

Setup Item	Selectable Range or Options	Default Value
Lower	0 to 95%	0
Upper	5 to 100%	100

#### Lower and Upper

Set these values when you want to divide the waveform displays of channels into separate zones so that waveforms do not overlap. Set the **Lower** and **Upper** positions as percentages of the maximum display width. Set **Lower** to a value less than **Upper**, and set the zone width (**Upper – Lower**) to be 5% or greater.



## Scale

Setup Item	Selectable Range or Options	Default Value
Position	GX20/GP20: Off, 1, 2, 3, 4, 5, 6, 7, 8, 9, 10 GX10/GP10: Off, 1, 2, 3, 4, 5, 6	1

### Position

Set this to set the scale display position of the trend display. Set this to **Off** to not display scales.

- ▶ For display examples, see the scale settings on page 1-40 in section 1.2.3, “Setting the Display”.

## Bar graph

Setup Item	Selectable Range or Options	Default Value
Base position	Lower, Center, Upper	Lower

### Base position

Set the bar graph base position. This setting is applied on the bar graph display and when you are displaying the current value on the scale as a bar graph on the trend displays.

- ▶ For display examples, see the bar graph settings on page 1-40 in section 1.2.3, “Setting the Display”.

## Display characters of each value

Setup Item	Selectable Range or Options	Default Value
0	Character string (up to 8 characters, <b>Aa#1</b> )	—
1	Character string (up to 8 characters, <b>Aa#1</b> )	—

### 0

Set the character string to display when the measured value is 0.

### 1

Set the character string to display when the measured value is 1.

- ▶ For usage examples, see page 1-40 in section 1.2.3, “Setting the Display”.

---

## 1.7 **Configuring Control Function and Configuring Program Control Function**

See the *Loop Control Function, Program Control Function (/PG Option) User's Manual* (IM 04L51B01-31EN).

## 1.8 Configuring Math Channels (/MT option)

Configure math channels. You can define expressions using measured data and computed data as variables, compute expressions, and display and save the results.

When the measurement mode is set to High speed or Dual interval, there is a limit to the number of math channels at scan intervals shorter than 100 ms. For details, see the following general specifications.

GX/10/GX20 Paperless Recorder (panel mount type)	GS 04L51B01-01EN
GP10/GP20 Paperless Recorder (portable type)	GS 04L52B01-01EN

### 1.8.1 Setting Basic Computation Operations (Error indications, operation at start, overflow handling, PSUM overflow<sup>1</sup> handling)

<sup>1</sup> Release number 3 and later

#### Path

GX/GP: **MENU** key > **Browse** tab > **Setting** > Setting menu **Math channel settings** > **Math action settings**

Web application: **Config.** tab > **Math channel settings** > **Math action settings**

Hardware configurator: **Math channel settings** > **Math action settings**

#### Description

Setup Item	Selectable Range or Options	Default Value
Value on Error	+Over, -Over	+Over
START/STOP key action <sup>1</sup>	Off, Start/Stop, Reset + Start/Stop	Start/Stop

<sup>1</sup> When the multi-batch function (/BT) is set to **On**, the default value is **Off**.

#### Value on Error

Set how to display computation errors.

#### START/STOP key action

Set the action to execute when the START/STOP key is pressed.

Options	Description
Off	Computation does not start or stop when the <b>START/STOP</b> key is pressed.
Start/Stop	Computation starts or stops when the <b>START/STOP</b> key is pressed.
Reset + Start/Stop	Computation starts or stops when the <b>START/STOP</b> key is pressed. Before computation starts, computation is reset.

#### Value on Overflow

Setup Item	Selectable Range or Options	Default Value
SUM, AVE	Error, Skip, Limit	Skip
MAX, MIN, P-P	Over, Skip	Over

#### SUM, AVE

Set how to handle overflow data when it is detected in the SUM or AVE computation of TLOG or CLOG. This setting is also applied to report generation and Rolling average.

Options	Description
Error	Sets the computation result to computation error.
Skip	Discards overflow data and continues the computation.
Limit	Replaces overflow data with the limit value and continues the computation.

## 1.8 Configuring Math Channels (/MT option)

### MAX, MIN, P-P

Set how to handle overflow data when it is detected in the MAX, MIN, or P-P computation of TLOG or CLOG. This setting is also applied to report generation.

Options	Description
Over	Computes by using the overflow data.
Skip	Discards overflow data and continues the computation.

### PSUM overflow handling

Setup Item	Selectable Range or Options	Default Value
Over/Rotate	Rotate, Over	Rotate

#### Over/Rotate

Set the handling of instances when the pulse integration result exceeds the displayable range of the math channel.

Options	Description
Rotate	Minimum value: 0 When the value falls below the minimum value, continue the computation by assuming the value of the next count to be the maximum value.
	Maximum value: 99999999 When the value exceeds the maximum value, continue the computation by assuming the value of the next count to be the minimum value.
Over	Minimum value: -9999999 When the value falls below the minimum value, set the result to overflow and stop the computation. (Computed result: -OVER)
	Maximum value: 99999999 When the value exceeds the maximum value, set the result to overflow and stop the computation. (Computed result: +OVER)

## 1.8.2 Setting Expressions

### Path

GX/GP: **MENU** key > **Browse** tab > **Setting** > Setting menu **Math channel settings** > **Calculation expression**

Web application: **Config.** tab > **Math channel settings** > **Channel range** (display example: A001-A020) > **Calculation expression**

Hardware configurator: **Math channel settings** > **Channel range** (display example: **A001 to A020**) > **Calculation expression**

### Description

Setup Item	Selectable Range or Options	Default Value
First-CH	GX20/GP20: A001 to A100 GX20-2/GP20-2: A001 to A200 <sup>1</sup> GX10/GP10: A001 to A050	A001
Last-CH	Same as the first channel	A001

<sup>1</sup> Release number 3 and later

#### First-CH, Last-CH

Set the target channels.

### Math range

Setup Item	Selectable Range or Options	Default Value
On/Off	Off, On	Off
Calculation expression <sup>1</sup>	Character string (up to 120 characters)	001
Decimal place <sup>1</sup>	0, 1, 2, 3, 4, 5	2
Span Lower <sup>1</sup>	-9999999 to 99999999	0.00
Span Upper <sup>1</sup>	-9999999 to 99999999	100.00
Unit <sup>1</sup>	Character string (up to 6 characters, <b>Aa#1</b> )	—

<sup>1</sup> Appears when On/Off is set to **On**.

**On/Off**

Set the channels that you want to use to **On**.

Computation is performed every scan interval, starting with the smallest channel number.

Example: If you specify A002=A001+A003, the value of the previous scan interval is used for A003.

**Calculation expression**

Set the expression.

In computations, measured values are handled as values without units. For example, if the measured data from channel 0001 is 20 mV and the measured data from channel 0002 is 20 V, the computed result of 0001 + 0002 is 40.

**Data That Can Be Used in Expressions**

You can use the data shown below in expressions.

Data	Notation	Description
I/O channel data	0001, etc.	Specify channel numbers.
Math channel data <sup>1</sup>	A001, etc.	Specify channel numbers.
Constant	K001 to K100	Values.
Variable constant <sup>5</sup>	W001 to W100	Values
Integer data	Z001 to Z999	Integers
Logic math data <sup>5,6</sup>	LM01 to LM50	Logic math data
Communication channel data <sup>2</sup>	GX20-1/GP20-1: C001 to C300 GX20-2/GP20-2: C001 to C500 GX10/GP10: C001 to C050	Specify communication channel numbers.
Communication channel raw data (release number 3 and later) <sup>3</sup>	GX20-1/GP20-1: RC001 to RC300 GX20-2/GP20-2: RC001 to RC500 GX10/GP10: RC001 to RC050	Reads the raw values (as-is) applied to the communication channels. Specify communication channel numbers.
Internal switch status	S001 to S100	1 or 0.
Flag	F01 to F20	1 or 0. Use the event action function to set the flag (for details, see section 1.6).
Recording status (release number 2 and later) <sup>4</sup>	GX20-2/GP20-2: REC01 to REC12 GX10/GP10/GX20-1/GP20-1: REC01 to REC06	Recording (1), not recording (0). If the multi-batch function (release number 3 and later, /BT option) is not in use, "REC01" shows the recording (memory sampling) status. If the multi-batch function is in use, "REC01" to "REC12" show the recording (memory sampling) status of each batch group. Recording status of invalid batch groups is 0.

1 /MT option

2 /MC option

3 /MC option

4 REC02 to REC12 are available in release number 3 and later.

5 Release number 4 and later

6 Can be used only for logic math.

## 1.8 Configuring Math Channels (/MT option)

Only the following types of data that are checked in the table below can be used in TLOG, CLOG, and PRE.

Comp. Type	Data	I/O channel	Math channel	Communication channel	Constant, variable constant	Internal switch	Flag	Recording status	Integer data
TLOG	✓	✓	✓	✓	✓	✓	✓	✓	✓
TLOG.PSUM	✓ <sup>1</sup>	✓	✓	✓	✓	✓	✓	✓	✓
CLOG	✓	✓	✓	✓	✓	✓	✓	✓	✓
PRE	✓	✓	✓	✓	✓	✓	✓	✓	✓
Other computations	✓	✓	✓	✓	✓	✓	✓	✓	✓

Bad examples: TLOG.SUM(S01), CLOG.AVE(0001.0002.K01), PRE(S01)

<sup>1</sup> Only applies to pulse input module channels.

### Decimal Place

Set the decimal place for span lower and span upper.

### Span Lower, Span Upper

Set the measurement range.

The decimal place is determined by the **Decimal place** setting.

### Unit

Set the unit of computed values.

### TLOG

Setup Item	Selectable Range or Options	Default Value
Timer type	Timer, Match Time Timer	Timer
Timer No.	1, 2, 3, 4, 5 <sup>1</sup> , 6 <sup>1</sup> , 7 <sup>1</sup> , 8 <sup>1</sup> , 9 <sup>1</sup> , 10 <sup>1</sup> , 11 <sup>1</sup> , 12 <sup>1</sup>	1
Sum scale	Off, sec, min, hour	Off
Reset	Off, On	Off

<sup>1</sup> Release number 3 and later

### Timer type

Set the timer type.

### Timer No.

Set the number of the timer that you want to use.

### Sum scale

Set the sum scale depending on the unit of measured values.

Set the sum scale when using sum computation (TLOG.SUM).

Example: If the unit of the measured value is "m<sup>3</sup>/min," select **min**.

If you select Off, the measured data is summed as-is once per scan interval.

**Reset**

To reset the TLOG computed value at each interval, select **On**.

The figure below illustrates the reset operation of sum computation (TLOG.SUM).

Example: Result of the TLOG.SUM computation

When reset is **On**, the sum value is computed over each interval. When set to **Off**, the sum value from computation start is computed.

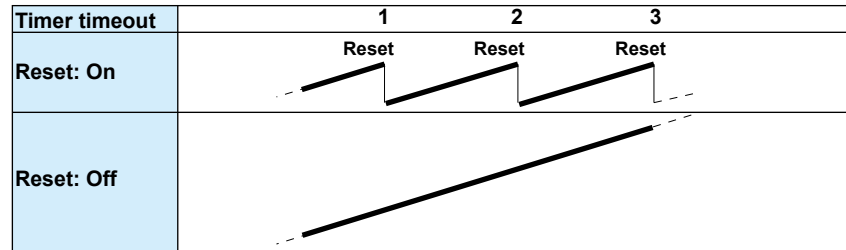

**Rolling average**

Setup Item	Selectable Range or Options	Default Value
On/Off	Off, On	Off
Interval <sup>1</sup>	1s, 2s, 3s, 4s, 5s, 6s, 10s, 12s, 15s, 20s, 30s, 1min, 2min, 3min, 4min, 5min, 6min, 10min, 12min, 15min, 20min, 30min, 1h	10s
Number of samples <sup>1</sup>	1 to 1500	1

<sup>1</sup> Appears when rolling average is **On**.

**On/Off**

Set this to **On** to perform rolling average.

**Interval**

Set the sampling interval for performing rolling average. The sampling interval takes on a value that is an integer multiple of the scan interval. For example, if the sampling interval is set to 5 s when the scan interval is 2 s, the actual sampling interval is 6 s.

**Number of samples**

Set the number of samples for performing rolling average.

The rolling average time is equal to the sampling interval × the number of samples.

**Note**

- If the number of data points to be averaged has not reached the specified number of samples immediately after computation is started, the average of the available data is computed.
- Computation error data is excluded from the rolling average computation.
- If the computed data exceeds the upper or lower limit, the data is handled according to the Value on Overflow setting.  
If it is set to Error or Skip, the computed data is not used in the rolling average computation. If set to Limit, the computed data is clipped at the upper or lower limit to compute the rolling average.  
The upper and lower limits are “±100000000” ignoring the decimal point. The decimal place is the same as that of the span lower limit.

**Explanation**

**TLOG Computation**

TLOG computation determines the sum, maximum, minimum, average, or the difference between the maximum and minimum of a specific channel for each interval determined by a timer.

**Computation Data Dropout**

A computation data dropout occurs if the computation is not completed within the scan interval.

However, TLOG.PSUM performs integration without being affected by computation data dropouts.

- The math icon in the status display section turns yellow.
- When a computation data dropout occurs, the computed data of the scan interval in which the dropout occurred is set to the data immediately before the dropout.
- If computation data dropout occurs frequently, reduce the load on the CPU by reducing the number of math channels or setting a longer scan interval.
- In report computation (integration, average) and TLOG (SUM, AVE), the most recent value is summed for the number of computation data dropout occurrences.

**Numeric Display and Recording**

The range of displayed values of computed data is from -9999999 to 99999999 excluding the decimal point. The decimal place corresponds to the decimal place of the lower limit span of the math channel. On the numeric display, values are displayed if the computed result is within the above range regardless of the upper and lower limits of span.

The following table indicates special displays.

Display/Recording	Computed Data Status
+Over	<ul style="list-style-type: none"> <li>• +Display over: When a computed result exceeds 99999999</li> <li>• +Computation over: When a value exceeds approximately 1.79E+308 in the middle of the computation</li> <li>• When a computation error<sup>1</sup> occurs (you can select +Over or -Over.)</li> </ul>
-Over	<ul style="list-style-type: none"> <li>• -Display over: When a computed result is less than -9999999</li> <li>• -Computation over: When a value is less than approximately -1.79E+308 in the middle of the computation</li> <li>• When a computation error<sup>1</sup> occurs (you can select +Over or -Over.)</li> </ul>

- <sup>1</sup> Computation error occurs when the following computation is carried out.
- /0, SQR(-X), or LOG(-X)
  - If a channel number set to skip or Off is used in the equation.
  - If error data is used in the equation.

**Special Data Processing**

This section explains the handling of special data in TLOG computation, CLOG computation, and reports.

**Power Failure Operation (TLOG and Reports)**

If a power failure occurs when the report function is enabled or in the middle of the TLOG computation, the report operation and TLOG computation resume when the GX/GP recovers from the power failure. The operation varies depending on whether the GX/GP recovers from the power failure before or after the time to create a report or the TLOG interval timeout.

Time of Recovery	Operation
After the time to create the data	The report data is created immediately after the GX/GP recovers. The measured data up to when the power failure occurred is used to create the report. When the time to create the next report data arrives, the data after the recovery is used. The interval timer for TLOG data expires immediately after the GX/GP recovers.
Before the time to create the data	After the GX/GP recovers, report data is created at the normal time to create the data. The measured data excluding the power failure period is used to create the report. The interval timer for TLOG data expires after the GX/GP recovers.



**Error Data Handling (TLOG, CLOG, and Reports)**

If an error occurs in the channel data, the error data is discarded, and the computation continues. If all the data are in error, an error results.

The following types of data are considered error data.

- Channels set to skip or Off.
- The measured result on an I/O channel is error (A/D converter failure, etc.).
- I/O channel input is in a burnout condition.
- The computed result on a math channel is error.

**Handling of Overflow Data<sup>1</sup>**

- <sup>1</sup> Refers to over range on an I/O channel, computation overflow on a math channel, and over range on a communication channel.

**For TLOG, CLOG, and Reports**

When the channel data is overflow data, the GX/GP handles it as follows:

Computation Type	Description
Average value or sum value	Set the handling to Error, Skip, or Limit. Error: Sets the computation result to computation error. Skip: Discards overflow data and continues the computation. Limit: Replaces overflow data with the limit value and continues the computation. Limit value: Measurement channels: Upper or lower limit of the selectable range of the specified range or the scale upper or lower limit Math channels, communication channels: Span upper or lower limit
Maximum, minimum, Maximum – minimum	Set the handling to Over or Skip. Over: Computes by using the overflow data. Skip: Discards overflow data and continues the computation.

**For Multiplication and Relation Computation EQ and NE**

Computation Type	Computation	Computed Result
Multiplication	0*(+Over)	0
	0*(-Over)	0
	(+Over)*0	0
	(-Over)*0	0
.EQ.	(+Over).EQ.(+Over)	0
	(-Over).EQ.(-Over)	0
.NE.	(+Over).NE.(+Over)	1
	(-Over).NE.(-Over)	1

## 1.8 Configuring Math Channels (/MT option)

### Handling of Math Channel Data (Difference between Cxxx and RCxxx)

- Cxxx uses the measured results of communication input from a PC or the like (display values of communication channel) in computation.
- RCxxx uses communication input from a PC or the like (display values of communication channel) directly in computation.

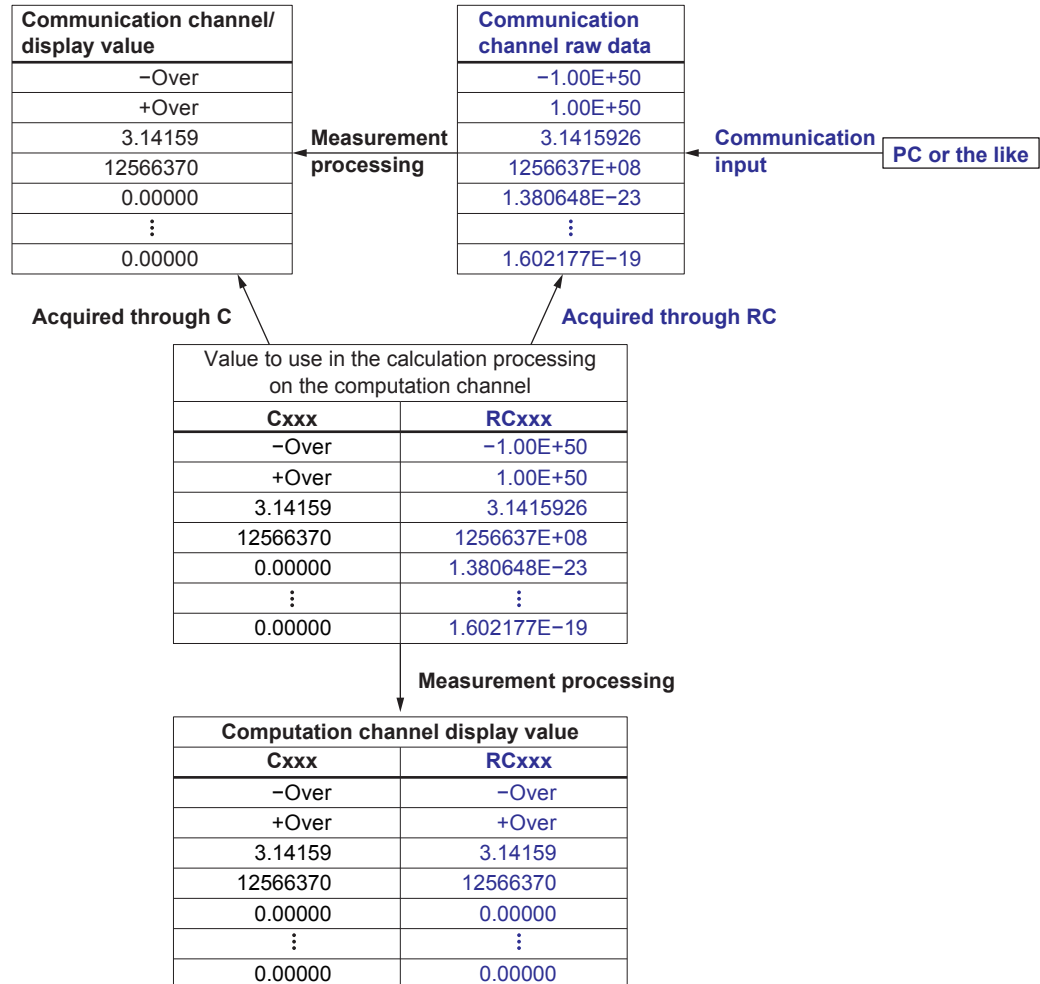

### Computational Processing When Measurement Mode Is Set to Dual Interval

- Computational is performed at the scan interval of the measurement group set with the master scan interval. If a channel in a measurement group using a scan interval different from the master scan interval is used, it is indefinite as to which measured value of this channel in time will be used for the difference calculation.
- Pulse integration (TLOG.PSUM) is performed only when the measured value of the channel used in the calculation expression is updated. However, computation is performed at the master scan interval.

### Computational Processing When the Measurement Mode Is Set to High Speed

Computation is performed at the scan interval, but computational processing is performed at 100 ms.

### 1.8.3 Writing Expressions

#### Common Items

Follow the rules below when writing expressions.

- Use up to 120 characters to write expressions.
- The precedence of computing terms can be specified using parentheses.
- Specify channels in expressions using channel numbers.  
Example: 0001, 0012, A001, C001, W1, Z1
- The "0" in the top digit of I/O channel numbers (0101), math channel numbers (A001), communication channel numbers (C010), constants (K), internal switch numbers (S), flags (F), and recording status (REC), variable constants (W), integer data (Z) can be omitted.  
Examples: 101, A1, C10, K1, S1, F1, REC1
- The data of the previous scan is used in the computation for its own channel number and channel numbers greater than its own channel number in the expression.
- Write special computations (HOLD, RESET, and CARRY) and conditional expressions at the beginning of expressions.

#### Order of Precedence in Computations

The order of precedence of computation in expressions is as follows:

Type	Computing Element
Function	ABS(), SQR(), LOG(), LN(), EXP(), TLOG.MAX(), TLOG.MIN(), TLOG.AVE(), TLOG.SUM(), TLOG.P-P(), TLOG.PSUM(), CLOG.MAX(), CLOG.MIN(), CLOG.AVE(), CLOG.SUM(), CLOG.P-P(), BIT, INT, SIN, COS, CLOG.PAVE, CP.O2, CP.CO2
Special computation and conditional expression	PRE, HOLD, RESET, CARRY, [a?b:c]
Power	**
Logical negation	NOT
Multiplication and division	*, /, MOD
Addition and subtraction	+, -
Greater than and less than	.GT. (or >), .LT. (or <), .GE. (or >=), .LE. (or <=)
Equal and not equal	.EQ. (or =), .NE. (or <>)
Logical product	AND
Logical sum and exclusive logical sum	OR, XOR

## 1.8 Configuring Math Channels (/MT option)

---

### Limitations

The following limitations exist in expressions.

Type	Limitations
TLOG Computation	A computing element cannot be written inside the parentheses. Only one TLOG computation can be specified in a single expression.
CLOG computation	The number of channels that can be written in the parentheses is up to 30 channels. A computing element cannot be written inside the parentheses. Only one CLOG computation can be specified in a single expression.
PRE	A computing element cannot be written inside the parentheses.
HOLD(a):b	Can only be written at the beginning of an expression. Only one HOLD computation can be specified in a single expression.
RESET(a):b	Can only be written at the beginning of an expression. Only one RESET computation can be specified in a single expression.
CARRY(a):b	Can only be written at the beginning of an expression. Only one CARRY computation can be specified in a single expression. Only TLOG.SUM can be written in b.
Conditional equation [a?b:c]	RESET, CARRY, or HOLD cannot be written to a, b, or c. Other computing elements cannot be combined (example: [a?b:c]+0001). However, conditional equations can be specified for a, b, and c.

## Basic Arithmetic

### Expression Examples

- Addition  $0001+0002$   
(Determines the sum of the measured values of channels 0001 and 0002)
- Subtraction  $0001-0002$   
(Determines the difference of the measured values of channels 0001 and 0002)
- Multiplication  $0001*K003$   
(Multiplies constant K003 to the measured value of channel 0001)
- Division  $0001/K002$   
(Divides the measured value of channel 0001 by constant K002)

## Power and Other Computations

### Expression Examples

- Power  $0001**0002$   
(Determines the measured value of channel 0001 to the power of the measured value of channel 0002)
- Square root  $SQR(0002)$   
(Determines the square root of the measured value of channel 0002)
- Absolute value  $ABS(0002)$   
(Determines the absolute value of the measured value of channel 0002)
- Common logarithm  $LOG(0001)$   
(Determines the common logarithm (log<sub>10</sub>) of the measured value of channel 0001)
- Natural logarithm  $LN(0001)$   
(Determines the natural logarithm of the measured value of channel 0001)
- Exponent  $EXP(0001)$   
(Determines e to the power of the measured value of channel 0001)

## Relational Computation

### Expression Examples

#### **0002.LT.0003, 0002<0003**

If the measured value of channel 0002 is less than the measured value of channel 0003, the computed result is 1.  
Otherwise, the result is 0.

#### **0002.GT.0003, 0002>0003**

If the measured value of channel 0002 is greater than the measured value of channel 0003, the computed result is 1.  
Otherwise, the result is 0.

#### **0002.EQ.0003, 0002=0003**

If the measured value of channel 0002 is equal to the measured value of channel 0003, the computed result is 1.  
Otherwise, the result is 0.

#### **0002.NE.0003, 0002<>0003**

If the measured value of channel 0002 is not equal to the measured value of channel 0003, the computed result is 1.  
Otherwise, the result is 0.

#### **0002.GE.0003, 0002>=0003**

If the measured value of channel 0002 is greater than or equal to the measured value of channel 0003, the computed result is 1. Otherwise, the result is 0.

#### **0002.LE.0003, 0002<=0003**

If the measured value of channel 0002 is less than or equal to the measured value of channel 0003, the computed result is 1. Otherwise, the result is 0.

### Logical Computation

Checks whether the two data values, e1 and e2 (e1 only for NOT), are zeros or non-zeros, and computes according to the conditions.

#### AND

Logical product

(Syntax) e1ANDe2

(Condition) If the two data values e1 and e2 are both non-zeros, the computed result is 1. Otherwise, it is 0.

(Explanation)  $e1 = 0, e2 = 0 \rightarrow e1ANDe2 = 0$   
 $e1 \neq 0, e2 = 0 \rightarrow e1ANDe2 = 0$   
 $e1 = 0, e2 \neq 0 \rightarrow e1ANDe2 = 0$   
 $e1 \neq 0, e2 \neq 0 \rightarrow e1ANDe2 = 1$

#### OR

Logical sum

(Syntax) e1ORe2

(Condition) If the two data values e1 and e2 are both zeros, the computed result is 0. Otherwise, it is 1.

(Explanation)  $e1 = 0, e2 = 0 \rightarrow e1ORe2 = 0$   
 $e1 \neq 0, e2 = 0 \rightarrow e1ORe2 = 1$   
 $e1 = 0, e2 \neq 0 \rightarrow e1ORe2 = 1$   
 $e1 \neq 0, e2 \neq 0 \rightarrow e1ORe2 = 1$

#### XOR

Exclusive OR

(Syntax) e1XORe2

(Condition) If the two data values e1 and e2 are zero and non-zero or non-zero and zero, the computed result is 1. Otherwise, it is 0.

(Explanation)  $e1 = 0, e2 = 0 \rightarrow e1XORe2 = 0$   
 $e1 \neq 0, e2 = 0 \rightarrow e1XORe2 = 1$   
 $e1 = 0, e2 \neq 0 \rightarrow e1XORe2 = 1$   
 $e1 \neq 0, e2 \neq 0 \rightarrow e1XORe2 = 0$

#### NOT

Logical negation

(Syntax) NOTe1

(Condition) The result is the inverse of the status of data e1 (zero or non-zero).

(Explanation)  $e1 = 0 \rightarrow NOTe1 = 1$   
 $e1 \neq 0 \rightarrow NOTe1 = 0$

#### Expression Example

0001-0002OR0003.GT.0004

Determines the OR of the computed results of "0001-0002" and "0003.GT.0004".

## TLOG Computation

TLOG computation determines the sum, maximum, minimum, average, or the difference between the maximum and minimum of a specific channel for each interval determined by a timer.

In the explanation below, an expression containing a computing element, an internal switch (S), and a flag (F) cannot be written in e1. In addition, only one TLOG computation can be specified in a single computing expression.

### TLOG.MAX( )

Maximum value

(Syntax) TLOG.MAX(e1)

(Condition) Determines the maximum value of channel e1.

### TLOG.MIN( )

Minimum value

(Syntax) TLOG.MIN(e1)

(Condition) Determines the minimum value of channel e1.

### TLOG.AVE( )

Average value

(Syntax) TLOG.AVE(e1)

(Condition) Determines the average value of channel e1.

### TLOG.SUM( )

Sum value

(Syntax) TLOG.SUM(e1)

(Condition) Determines the sum of channel e1.

### TLOG.P-P( )

Maximum – minimum value

(Syntax) TLOG.P-P(e1)

(Condition) Determines the maximum - minimum value of channel e1.

### TLOG.PSUM( )

Sum value

(Syntax) TLOG.PSUM(e1)

(Condition) Determines the sum of channel e1.<sup>1</sup>

<sup>1</sup> Only GX90XP pulse input module channels.

### Expression Example

TLOG.MAX(0001)+K001\*SQR(0002)

### Examples of Equations That Are Not Allowed

TLOG.AVE(0001)+TLOG.AVE(0002)

Reason: TLOG appears twice in one equation.

TLOG.AVE(ABS(0001))

Reason: A computing element is used inside the parentheses.

### CLOG Computation

Only data of I/O channels, math channels, and communication channels can be used in CLOG computations. Up to 30 channels can be written in the parentheses.

In the explanation below, an expression containing a computing element cannot be written to e1, etc. In addition, only one CLOG computation can be specified in a single computing expression.

#### **CLOG.SUM( )**

Sum value

(Syntax) CLOG.SUM(e1.e2.e4-e6)

(Condition) Determines the sum of the data of channels e1, e2, e4, e5, and e6 that are measured at the same time.

#### **CLOG.MAX( )**

Maximum value

(Syntax) CLOG.MAX(e1.e2.e4-e6)

(Condition) Determines the maximum value among the data of channels e1, e2, e4, e5, and e6 that are measured at the same time.

#### **CLOG.MIN( )**

Minimum value

(Syntax) CLOG.MIN(e1.e2.e5.e7)

(Condition) Determines the minimum value among the data of channels e1, e2, e5, and e7 that are measured at the same time.

#### **CLOG.AVE( )**

Average value

(Syntax) CLOG.AVE(e1-e6)

(Condition) Determines the average value among the data of channels e1 to e6 that are measured at the same time.

#### **CLOG.P-P( )**

Maximum – minimum value

(Syntax) CLOG.P-P(e1.e2.e5.e7)

(Condition) Determines the difference between the maximum and minimum values among the data of channels e1, e2, e5, and e7 that are measured at the same time.

#### **CLOG.PAVE( ) (Release number 4 and later)**

(Syntax) CLOG.PAVE(e1.e2.e3.e4.e5.e6.e7)

(Condition) Determines the average value by excluding input that falls outside a given width from the pattern (SP) during program operation. For e1 to e4 only, constants and variable constants can be used.

e1: Calculation method switch flag (decimals rounded, computed as CLOG.AVE if zero)

e2: Loop number (decimals truncated)

e3: Effective width for ramp

e4: Effective width for soak

e5, e6, e7: Channels for calculating the average

#### **Expression Example**

CLOG.MAX(0001.0002.A004-A006)+K001\*SQR(0002)

#### **Examples of Equations That Are Not Allowed**

CLOG.AVE(0001.0003.0005)+CLOG.AVE(0002.0004.0006)

Reason: CLOG appears twice in one equation.

CLOG.AVE(001.ABS(001))

Reason: A computing element is used inside the parentheses.



## Special Computations

### PRE( )

(Syntax) PRE(e1)

(Condition) Determines the previous value of e1.

### HOLD(a):b

(Syntax) HOLD(a):b

(Condition) When a is zero, b is carried out to derive the computed value. Otherwise, the previous computed value is held.

#### Expression Example

Under normal conditions, TLOG.SUM(0001) is carried out to derive the computed value. When [0001] exceeds K01, the previous computed value is held.

HOLD(0001.GT.K001):TLOG.SUM(0001)

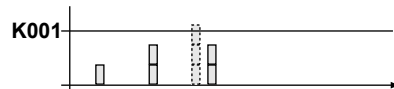

### RESET(a):b

(Syntax) RESET(a):b

(Condition) When a is zero, b is carried out to derive the computed value. Otherwise, the previous computed value of b is reset, and b is carried out to derive the computed value.

#### Expression Example

Under normal conditions, TLOG.SUM(0001) is carried out to derive the computed value. When [A001] exceeds K01, the previous computed value is reset, and TLOG.SUM(0001) is carried out.

RESET(A001.GT.K001):TLOG.SUM(0001)

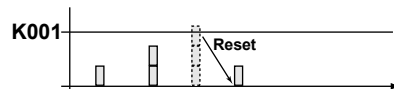

### CARRY(a):b

(Syntax) CARRY(a):b

(Condition) Only TLOG.SUM can be specified for b. If the computed value X of b is less than a, the computed result is X. If X is greater than or equal to a, the computed result is the excess (X - a).

(Explanation) When a value such as the flow rate is summed and the threshold value is reached or exceeded, the sum value is reset while carrying over the amount that exceeded the threshold value.

#### Expression Example

Expression that sums the values of channel 0001 and resets the value when it reaches or exceeds 10000.

K001=10000

CARRY(K001):TLOG.SUM(0001)

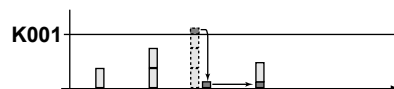

### Examples of Equations That Are Not Allowed

0002+HOLD(K001):TLOG.SUM(0001)

Reason: HOLD is not at the beginning of the expression.

RESET(A001.GT.K001):TLOG.SUM(0001)+RESET(A001.GT.K001):0002

Reason: RESET appears twice in one equation.

### Conditional Expression

**[a?b:c]**

(Syntax) [0001.GT.K001?0002:0003]

(Condition) If the measured value of channel 0001 is greater than constant K001, the computed result is the measured value of channel 0002. Otherwise, the computed result is the measured value of channel 0003.

#### Examples of Equations That Are Not Allowed

[0001.GT.K001?0002:0003]\*K002

Reason: Used in combination with another computing element.

#### Nested Conditional Expressions

A conditional expression can be written to Expression1, Expression2, and Expression3 in the equation [Expression1?Expression2:Expression3]. For example, the following expression is allowed: [Equation1?[Equation2-1?Equation2-2:Equation2-3]:[Equation3-1?Equation3-2:Equation3-3]].

Expressions can be nested as long as the number of characters of the expression does not exceed 120 characters.

### Bit Operation (Release number 2 and later)

**BIT**

(Syntax) BIT.Bnn (0001)

(Condition) Assuming that the channel 0001 data (positive integer) is bit data, the nth (B00 to B31) bit is output. If the target bit is 1, the computed result is 1. If the target bit is 0, the computed result is 0.

The higher digit "0" in "Bnn" cannot be omitted.

(Explanation) The status information (e.g., test information) of a lower-level device can be extracted via Modbus communication and processed using bit operation. The result can be used in alarms, event action, and so on.

If the value includes a decimal, the value is rounded to the nearest integer before performing calculation.

If the input data is 0 or a negative number, the output value is 0.

If the input value is not a number (e.g., ±Over or error), the computed result is error. The error display varies depending on the Value on Error setting in Math action settings.

If computation is performed on a communication channel (maximum data value: 99999999) the valid bit specification is up to B26.

If computation is performed on communication channel raw data (RC), the valid bit specification is up to B31.

Example when the data value is 3 (0000 0000 0000 0000 0000 0000 0000 0011)

For B01

BIT.B01(RC001) = 1

For B02

BIT.B02(RC001) = 0

**Integer Extraction Operation (Release number 2 and later)****INT**

(Syntax) INT (0001)

(Condition) Determines the maximum integer that does not exceed the channel 0001 data value. If the channel 0001 data value is 123.45, the computed result is 123.

(Explanation) Operation example

When channel 0001 is 4.3

INT (0001) = 4.0

When channel 0001 is 5.5

INT (0001) = 5.0

When channel 0001 is -2.2

INT (0001) = -3.0

When channel 0001 is -3.8

INT (0001) = -4.0

**Remainder Extraction Operation (Release number 2 and later)****MOD**

(Syntax) 0001.MOD.K001

(Condition) Determines the remainder when channel 0001 is divided by constant K001.

(Explanation) Operation example

When channel 0001 is 10 and channel K001 is 3

0001 .MOD. K001 = 1

When channel 0001 is 7.5 and channel K001 is -2

0001 .MOD. K001 = -0.5

When channel 0001 is -6 and channel K001 is 2.5

0001 .MOD. K001 = 1.5

When channel 0001 is -8.5 and channel K001 is -4.5

0001 .MOD. K001 = -4.0

**Trigonometric Functions (Release number 2 and later)****SIN**

(Syntax) SIN (0001)

(Condition) Determines the sine value assuming the channel 0001 data value to be an angle in degrees.

**COS**

(Syntax) COS (0001)

(Condition) Determines the cosine value assuming the channel 0001 data value to be an angle in degrees.

**Note**

////////////////////////////////////  
 If the input data to a trigonometric function is in radians, you can use the following equation to convert into degrees.

$$\text{(degrees) } [^\circ] = \text{(radians) } [\text{rad}] \times 180 / \text{Pi}$$

////////////////////////////////////

### CP Calculation (Release number 4 and later)

#### CP.O2

(Syntax) CP.O2 (e1.e2.e3)

(Condition) e1: Furnace temperature (727.7°C to 1500.0°C or 1341.86 F to 2732.00 F.  
The furnace temperature unit is the same as the temperature unit setting.)  
e2: CO partial pressure (0 vol% to 100 vol%)  
e3: Zirconia O2 sensor electromotive force (0 V to 2 V)

(Explanation) Determines the CP value [wt%] from the zirconia O2 sensor electromotive force, CO partial pressure, and furnace temperature.  
If a value outside the range is input in e1 to e3, the calculated result will be 2.00000.

#### CP.CO2

(Syntax) CP.CO2 (e1.e2.e3)

(Condition) e1: Furnace temperature (727.7°C to 1500.0°C or 1341.86 F to 2732.00 F.  
The furnace temperature unit is the same as the temperature unit setting.)  
e2: CO partial pressure (0 vol% to 100 vol%)  
e3: CO2 partial pressure (0 vol% to 100 vol%)

(Explanation) Determines the CP value [wt%] from the O2 partial pressure, CO partial pressure, and furnace temperature. If a value outside the range is input in e1 to e3, the calculated result will be 2.00000.

## 1.8.4 Setting Alarms

### Path

GX/GP: **MENU** key > **Browse** tab > **Setting** > Setting menu **Math channel settings** > **Alarm**

Web application: **Config.** tab > **Math channel settings** > **Channel range** (display example: A001-A020) > **Alarm**

Hardware configurator: **Setting** tab > **Math channel settings** > **Channel range** (display example: A001-A020) > **Alarm**

### Description

Setup Item	Selectable Range or Options	Default Value
First-CH	GX20/GP20: A001 to A100 GX10/GP10: A001 to A050	A001
Last-CH	Same as the first channel	A001

### First-CH, Last-CH

Set the target channels.

### Level 1, Level 2, Level 3, Level 4

Setup Item	Selectable Range or Options	Default Value
On/Off	Off, On	Off
Type <sup>1</sup>	H: High limit, L: Low limit, T: Delay high limit, t: Delay low limit	H: High limit
Value <sup>1</sup>	-9999999 to 99999999	0.00
Hysteresis <sup>1,3</sup>	Numeric value (0 to 100000)	0.00
Logging <sup>1</sup>	Off, On	On
Output type <sup>1</sup>	Off, Relay, Internal switch	Off
Output No. <sup>2</sup>	DO channel or internal switch	—

1 Appears when On/Off is set to **On**.

2 Appears when Output type is not set to **Off**.

3 Appears when the type is set to **H:High limit** or **L:Low limit**.

### On/Off

To use an alarm level (1 to 4), set this to **On**.

### Type

Set the alarm type.

► For details, see page 1-35 in section 1.2.2, "Setting Alarms".

### Value

Set the alarm value for the specified alarm type.

Options	Value
H, L	Within -9999999 to 99999999 excluding the decimal point.
T, t	Same as H and L

## 1.8 Configuring Math Channels (/MT option)

### Hysteresis

Set this to establish an offset between the value used to activate and release alarms.

### Logging

Set this **On** to display an alarm (notify you) when an alarm occurs. If set to **Off**, when an alarm occurs, the GX/GP outputs signals to alarm output DO channels or internal switches but does not display the alarm. Alarms are also not recorded in the alarm summary.

### Output type

Set the alarm output destination type.

### Output No.

Set the number of the DO channel or internal switch to output alarms to.

## Alarm delay

Setup Item	Selectable Range or Options	Default Value
Hour	0 to 24	0
Minute	0 to 59	0
Second	0 to 59	10

### Hour, Minute, and Second

Set the alarm delay value. These values are valid when the delay high limit or delay low limit is in use.

## 1.8.5 Setting the Display

### Path

GX/GP: **MENU** key > **Browse** tab > **Setting** > Setting menu **Math channel settings** > **Display settings**

Web application: **Config.** tab > **Math channel settings** > **Channel range** (display example: A001-A020) > **Display settings**

Hardware configurator: **Math channel settings** > **Channel range** (display example: **A001 to A020**) > **Display settings**

### Description

Setup Item	Selectable Range or Options	Default Value
First-CH	GX20/GP20: A001 to A100 GX10/GP10: A001 to A050	A001
Last-CH	Same as the first channel	A001

### First-CH, Last-CH

Select the target channels.

## Tag

Setup Item	Selectable Range or Options	Default Value
Characters	Character string (up to 32 characters, <b>Aa#1</b> )	—
No.	Character string (up to 16 characters, <b>Aa#1</b> )	—

### Characters

Set the tag.

Not all characters may be displayed due to space constraints.

### No.

Set the tag number.

## Color

Setup Item	Selectable Range or Options	Default Value
Color	24 colors (red, green, blue, blue violet, brown, orange, yellow-green, light blue, violet, gray, lime, cyan, dark blue, yellow, light gray, purple, black, pink, light brown, light green, dark gray, olive, dark cyan, and spring green) and a user-defined color (1 color)	—

### Color

Set channel display colors. The colors apply to the trend display and bar graph display.

- ▶ For instructions on how to set the user-defined color, see page 1-40 in section 1.2.3, “Setting the Display”.

## Zone

Setup Item	Selectable Range or Options	Default Value
Lower	0 to 95%	0
Upper	5 to 100%	100

### Lower and Upper

Set these values when you want to divide the waveform displays of channels into separate zones so that waveforms do not overlap. Set the **Lower** and **Upper** positions as percentages of the maximum display width. Set **Lower** to a value less than **Upper**, and set the zone width (**Upper – Lower**) to be 5% or greater.

- ▶ For display examples, see page 1-40 in section 1.2.3, “Setting the Display”.

## Scale

Setup Item	Selectable Range or Options	Default Value
Position	GX20/GP20: Off, 1, 2, 3, 4, 5, 6, 7, 8, 9, 10 GX10/GP10: Off, 1, 2, 3, 4, 5, 6	1
Division	4, 5, 6, 7, 8, 9, 10, 11, 12, C10	10

### Position

Set this to set the scale display position of the trend display. Set this to **Off** to not display scales.

### Division

Set the number of divisions to make with the main scale marks.

C10: The scale is equally divided into 10 sections by main scale marks, and scale values are indicated at 0, 30, 50, 70, and 100% positions.

- ▶ For scale display examples, see page 1-40 in section 1.2.3, “Setting the Display”.

## Bar graph

Setup Item	Selectable Range or Options	Default Value
Base position	Lower, Center, Upper	Lower
Division	4, 5, 6, 7, 8, 9, 10, 11, 12	10

### Base position

Set the bar graph base position. This setting is applied on the bar graph display and when you are displaying the current value on the scale as a bar graph on the trend displays.

- ▶ For bar graph display examples, see page 1-40 in section 1.2.3, “Setting the Display”.

### Division

Set the number of divisions to make with the main scale marks.

## 1.8 Configuring Math Channels (/MT option)

### Partial<sup>1</sup>

Setup Item	Selectable Range or Options	Default Value
On/Off	Off, On	Off
Expand	1 to 99(%)	50%
Boundary	Span lower limit + 1 digit to span upper limit – 1 digit	0.01

<sup>1</sup> Appears when in the **Display settings** of the setting menu, the trend partial expansion **On/Off** is set to **On**.

### On/Off

Set this to **On** to enable partial expanded display.

### Expand

Set at which position to display the value specified by **Boundary** within the display width. Specify a percentage.

### Boundary

Set the value that is to be the boundary between the reduced section and the expanded section in the range of “minimum span value + 1 digit to maximum span value – 1 digit.” For channels that are set to scaling, the selectable range is “minimum scale value + 1 digit to maximum scale value – 1 digit.”

Example: Computation span: 0 to 100. Expand: 30. Boundary: 50The 0 to 50 range is displayed in the 0% to 30% range, and the 50 to 100 range is displayed in the 30% to 100% range.

- For details on this function, see page 1-114 in section 1.10.4, “Setting Trend Display Conditions”.

### Color scale band

Setup Item	Selectable Range or Options	Default Value
Band area	Off, In, Out	Off
Color	24 colors (red, green, blue, blue violet, brown, orange, yellow-green, light blue, violet, gray, lime, cyan, dark blue, yellow, light gray, purple, black, pink, light brown, light green, dark gray, olive, dark cyan, and spring green) and a user-defined color (1 color)	
Display position Lower	Span Lower to Span Upper	0.00
Display position Upper	Span Lower to Span Upper	1.00

### Band area

Displays a specified section of the measurement range using a color band on the scale. This setting is shared with the bar graph display.

Options	Description
Off	Disables the function.
In	Displays the area inside using the color band.
Out	Displays the area outside using the color band.

### Color

Set the display color.

- For instructions on how to set the user-defined color, see page 1-40 in section 1.2.3, “Setting the Display”.

### Display position Lower, Display position Upper

Set the display position. Set a value within the span or scale range.

- For color band display examples, see page 1-40 in section 1.2.3, “Setting the Display”.



## Alarm point mark



Setup Item	Selectable Range or Options	Default Value
Indicate on scale	Off, On	On
Mark kind	Alarm, Fixed	Alarm
Alarm 1 color to Alarm 4 color <sup>1</sup>	24 colors (red, green, blue, blue violet, brown, orange, yellow-green, light blue, violet, gray, lime, cyan, dark blue, yellow, light gray, purple, black, pink, light brown, light green, dark gray, olive, dark cyan, and spring green) and a user-defined color (1 color)	

<sup>1</sup> Appears when the Mark kind is set to **Fixed**.

### Indicate on scale

Set this to **On** to display alarm point marks on the scale. Set this to **Off** to not display them. This setting is shared with the bar graph display.

### Mark kind

Options	Description	Mark Shape
Alarm	Displayed normally in green. Displayed in the specified color when an alarm occurs.	 or 
Fixed	Displayed with a fixed color.	

### Alarm 1 color to Alarm 4 color

When Mark kind is set to **Fixed**, set the display colors of point marks for alarm levels 1 to 4.

## 1.8.6 Setting Constants to Use in Computation

### Path

GX/GP: **MENU** key > **Browse** tab > **Setting** > Setting menu **Math channel settings** > **Constant**

Web application: **Config.** tab > **Math channel settings** > **Constant**

Hardware configurator: **Math channel settings** > **Constant**

### Description

Setup Item	Selectable Range or Options	Default Value
Number of constant	K001-K010, K011-K020, K021-K030, K031-K040, K041-K050, K051-K060, K061-K070, K071-K080, K081-K090, K091-K100	K001-K010

### Number of constant

Select a range of constant numbers you want to set (in units of 10 numbers).

### Constant

Setup Item	Selectable Range or Options	Default Value
K001 to K100	-9.999999E+29 to 9.999999E+29 -9.999999E+29 to -1.000000E-30, 0, 1.000000E-30 to 9.999999E+29	0

### K001 to K100

Set constants. The number of significant digits of a constant is eight. When specifying a constant using exponential notation, set the mantissa using up to 8 digits and the exponent using up to 2 digits. The constants in the range specified by **Number of constant** are displayed.

### 1.8.7 Setting Variable Constants to Use in Computation

Variable constants are constants that can be varied even when computation or recording is in progress. They can be used for math and logic math.

You can vary variable constants on the setting screen or tuning screen (when the PID control module is installed).

#### Path

GX/GP: **MENU** key > **Browse** tab > **Setting** > Setting menu **Math channel settings** > **Variable constant**

Web application: **Config.** tab > **Math channel settings** > **Variable constant**

Configurator: **Math channel settings** > **Variable constant**

#### Description

Setup Item	Selectable Range or Options	Default Value
Number of constant	W001-W010/W011-W020/W021-W030/ W031-W040/W041-W050/W051-W060/ W061-W070/W071-W080/W081-W090/ W091-W100	W001-W010

#### Constant number

Select a range of constant numbers you want to set (in units of 10 numbers).

#### Constant

Setup Item	Selectable Range or Options	Default Value
W001 to W100	-9.999999E+29 to 9.999999E+29 -9.999999E+29 to -1.000000E-30, 0, 1.000000E-30 to 9.999999E+29	0

#### W001 to W100

Set the constant. The number of significant digits of a constant is eight. When specifying a constant using exponential notation, set the mantissa using up to 8 digits and the exponent using up to 2 digits. The constants in the range specified by Constant number are displayed.

## 1.9 Configuring Logic Math (/MT option)

Logic math is a function that outputs calculated results as 0 or 1 to relays (DOs) or internal switches.

### Path

GX/GP: **MENU** key > **Browse** tab > **Setting** > Setting menu **Logic math settings**  
 Web application: **Config.** tab > **Logic math settings**  
 Hardware configurator: **Config.** tab > **Logic math settings**

### Description

#### Logic math number

Setup Item	Selectable Range or Options	Default Value
Logic math number	GX10/GP10: LM01 to LM20 GX20/GP20: LM01 to LM50	—

#### Logic math number

You can set up to 20 logic math expressions on the GX10/GP10 and up to 50 expressions on the GX20/GP20. Select the number of the logic math expression you want to set.

#### Output

Setup Item	Selectable Range or Options	Default Value
Output type	Off, Switch/Relay	Off
Output No.	DO channel or internal switch	—

#### Output type

Select the output type of the calculated result.

#### Output No.

Select the output number of the calculated result. You can only select internal switch numbers, relay (DO) channels, or PID control module's DO with the type set to manual.

#### Calculation expression

Type	Computing Element
Auxiliary operation	+, -
Basic arithmetic	+, -, *, /
Relational operation	.GT., .GE., .LT., .LE., .EQ., .NE., >, >=, <, <=, =, <>
Logical operation	AND, OR, NOT, XOR
Conditional operation	[expression 1 ? expression 2 : expression 3]
Bit operation	BIT.Bnn()

Up to 120 characters can be entered in a calculation expression.

#### Data That Can Be Used in Expressions

► See page 1-84 in section 1.8.2, "Setting Expressions".

#### Note

You cannot change the calculation expression while recording is in progress.

**Description**

The internal switch or relay output is 0 when the calculated result of logic math is as follows (or 1 otherwise).

- When the calculated result is greater than -0.5 and less than 0.5
- When the calculated result is in error

**Operation Interval**

Computation and updating of the output operate at the scan interval. However, if the scan interval is less than 100 ms, it runs at 100 ms.

If the measurement mode is set to dual interval, logic math runs according to the master scan interval.

**Starting**

Operation starts when the logic math setting is changed to a value other than off. It is not affected by the starting and stopping of math, recording or control.

**About the Logic Math Data (LM)**

Logic math data is used when you want the result of a logic math operation to be reflected in the operation of another logic math number in the same period. The function returns a 1 when the logic math operation outputs a 1 and 0 when the operation outputs a 0. The function also returns a 0 when the output type of the specified logic math number is set to Off.

The data cannot be used in the calculation expression of a math channel.

LM values are retained only during the same scan interval.

**Operating Conditions**

The relay (DO channel) values used in logic math are displayed values (values that reflect energized or de-energized).

Logic math is applied to the internal switches and relays (DOs) after the next interval. If you want to reflect the results of logic math within the same interval, use logic math data (LM).

Example: Differences in the logic math results depending on the calculation expression

	Logic math number	Output		Calculation expression	
		Output type	Output No.	Setting 1	Setting 2
Settings	LM01	Internal switch	1	W001	W001
	LM02	Internal switch	2	S001	LM01
	LM03	Internal switch	3	S002	LM02
Results	First interval		Internal switch 1	1	1
			Internal switch 2	0	1
			Internal switch 3	0	1
	Second interval		Internal switch 1	1	1
			Internal switch 2	1	1
			Internal switch 3	0	1
	Third interval		Internal switch 1	1	1
			Internal switch 2	1	1
			Internal switch 3	1	1

If multiple logic math operations set the same output, the result of the logic math with the largest logic math number is reflected. However, for the logic math data (LM), the calculated result of that number is reflected.

Example: When multiple logic math operations specify the same output

Settings

Logic math 1 (LM01)

Output type: Internal switch

Output No.: 1

Calculation expression: W001 (W001 is set to 1)

Logic math 2 (LM02)

Output type: Internal switch

Output No.: 1

Calculation expression: W002 (W002 is set to 0)

Values after calculation

Internal switch 1 = 0

LM01=1

LM02=0

# 1.10 Setting Display Conditions

Set the display conditions.

## 1.10.1 Setting the Trend Interval

This setting is not available when the measurement mode is High speed.

### Path

GX/GP: **MENU** key > **Browse** tab > **Setting** > Setting menu **Display settings** > **Trend interval**

Web application: **Config.** tab > **Display settings** > **Trend interval**

Hardware configurator: **Display settings** > **Trend interval**

### Description

Setup Item	Selectable Range or Options	Default Value
Trend interval [div] (recording interval) <sup>1</sup>	5s (100ms), <sup>2,3</sup> 10s (200ms), <sup>2,3</sup> 15s (500ms), <sup>2</sup> 30s (1s), 1min (2s), 2min (4s), 5min (10s), 10min (20s), 15min (30s), 20min (40s), 30min (1min), 1h (2min), 2h (4min), 4h (8min), 10h (20min)	1min (2s)
Trend rate switching	Off, On	Off
Second interval [div] (recording interval) <sup>1</sup>	5s (100ms), <sup>2</sup> 10s (200ms), <sup>2</sup> 15s (500ms), <sup>2</sup> 30s (1s), 1min (2s), 2min (4s), 5min (10s), 10min(20s), 15min (30s), 20min (40s), 30min (1min), 1h(2min), 2h (4min), 4h (8min), 10h (20min)	1min (2s)

- 1 Does not appear if the recording mode is set to **Event** in basic settings under recording settings. Appears when trend rate switching is set to **On**.
- 2 Cannot be specified if an electromagnetic relay type (type suffix code -T1) analog input module is in use (configured).
- 3 Cannot be specified if a low withstand voltage relay type (type suffix code -L1) analog input module is in use (configured).

### Trend interval [div]

Set the trend interval.

### Relationship between the Scan Interval and Trend Interval

The shortest trend interval that you can specify varies depending on the scan interval.

Scan Interval	Shortest Trend Interval
100 ms	5 s
200 ms	10 s
500 ms	15 s
1 s	30 s
2 s	1 min
5 s	5 min

### Trend rate switching

Set this to **On** to enable the function that switches the trend interval while the recording is in progress.

During data acquisition, you can switch from the normal trend interval to the secondary trend interval. You can also switch back to the normal trend interval.

When the measurement mode is set to dual interval, this is fixed to Off.

When trend interval switching is set to On, you can change between the event data's trend intervals that are determined by the recording interval setting.

### Note

Only the displayed time axis changes when you switch to the secondary trend interval. The trend interval of recording data does not change.

**Second interval [/div]**

Set the time per division for the secondary interval. You cannot choose a secondary interval that is shorter than the scan interval.

**Explanation**

If the recording mode is set to Event and trend rate switching (Second interval) is set to Off, the trend interval depends on the recording interval of event data. If trend rate switching (Second interval) is set to On, you can specify any trend interval you want. However, the minimum trend interval that you can set depends on the scan interval.

**Recording Interval of Event Data and Trend Interval**

<b>Recording interval</b>	1 ms	2 ms	5 ms	10 ms	20 ms	50 ms	
<b>Trend interval [/div]</b>	100 ms	200 ms	500 ms	1 s	2 s	3 s	
<b>Recording interval</b>	100ms	200ms	500ms	1s	2s	5s	10s
<b>Trend interval [/div]</b>	5s	10s	15s	30s	1min	150s	5min
<b>Recording interval</b>	15s	20s	30s	1min	2min	5min	10min
<b>Trend interval [/div]</b>	450s	10min	15min	30min	1h	150min	5h
<b>Recording interval</b>	15min	20min	30min				
<b>Trend interval [/div]</b>	450min	10h	15h				

**1.10.2 Setting Display Groups**

Assign channels and set the group name for each display group. Set lines at specified positions in the waveform display range on the Trend display. Set to display a scale with a scale image.

If the multi-batch function (/BT option) is enabled, see the multi-batch function manual (IM 04L51B01-03EN).

**Path**

GX/GP: **MENU** key > **Browse** tab > **Setting** > Setting menu **Display settings** > **Group settings**

Web application: **Config.** tab > **Display settings** > **Group settings** > **Group No. (display example: 1-20)**

Hardware configurator: **Display settings** > **Group settings** > **Group No. (display example: 1-20)**

**Description**

Setup Item	Selectable Range or Options	Default Value
Group number	GX20-1/GP20-1: 1 to 50 GX20-2/GP20-2: 1 to 60 GX10/GP10: 1 to 30	1

**Group number**

Select the target group number.

**Group settings**

Setup Item	Selectable Range or Options	Default Value
On/Off	Off, On	Off
Group name	Character string (up to 16 characters, <b>Aa#1</b> )	—
Measurement group number <sup>1</sup>	Measurement group 1, measurement group 2	Measurement group 1
Channel set	GX20/GP20: Up to 20 GX10/GP10: Up to 10	—

<sup>1</sup> Appears when the measurement mode is Dual interval

## 1.10 Setting Display Conditions

### On/Off

Set this to **On** to use the target group number.

### Group name

Set the group name.

### Measurement group number

When the measurement mode is set to dual interval, set the measurement group number to assign to the group.

### Channel set

Select from AI channels, DI channels, DO channels, math channels (/MT option), and y6y6communication channels (/MC option).

## Scale image

Setup Item	Selectable Range or Options	Default Value
On/Off	Off, On	Off

### On/Off

Set this to **On** to display a scale with a scale image.

- ▶ For instructions on how to create scale images, see page App-26 in section Appendix 6, “Creating Scale Images”
- ▶ For details on loading, deleting, and saving scale images, see page 1-228 in section 1.25.2, “Loading and Deleting Scale Images”

## Trip line 1 to 4

Set lines at specified positions in the waveform display range on the Trend display.

Setup Item	Selectable Range or Options	Default Value
On/Off	Off, On	Off
Position	0 to 100%	50
Color	24 colors (red, green, blue, blue violet, brown, orange, yellow-green, light blue, violet, gray, lime, cyan, dark blue, yellow, light gray, purple, black, pink, light brown, light green, dark gray, olive, dark cyan, and spring green) and a user-defined color (1 color)	—
Line width	Thick, Normal, Thin	Normal

### On/Off

Set this to **On** to display trip lines.

### Position

Set the display position in the range of 0 to 100% of the display width.

### Color

Set the display color.

### Line width

Set the trip line width.



### 1.10.3 Setting Messages

**Path**

GX/GP: **MENU** key > **Browse** tab > **Setting** > Setting menu **Display settings** > **Message settings**

Web application: **Config.** tab > **Display settings** > **Message settings**

Hardware configurator: **Display settings** > **Message settings**

**Description**

Setup Item	Selectable Range or Options	Default Value
Message number	1-10, 11-20, 21-30, 31-40, 41-50, 51-60, 61-70, 71-80, 81-90, 91-100	1-10

**Message number**

Select a range of message numbers you want to set (in units of 10 numbers).

**Message**

Setup Item	Selectable Range or Options	Default Value
Message 1 to 100	Character string (up to 32 characters, <b>Aa#1</b> )	—

**Message 1 to 100**

Set messages in the range specified by Message number.

**Writing Messages**

You can recall preset messages and write them. With free messages, you can set messages when you need to write them.

**Preset messages**

1	START
2	HOLD
3	
4	

**Free message**  
Set the message when writing the message

**Trend display**

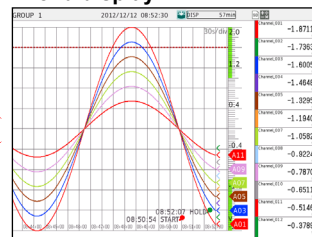

### 1.10.4 Setting Trend Display Conditions

**Path**

GX/GP: **MENU** key > **Browse** tab > **Setting** > Setting menu **Display settings** > **Trend settings**

Web application: **Config.** tab > **Display settings** > **Trend settings**

Hardware configurator: **Display settings** > **Trend settings**

**Description**

Setup Item	Selectable Range or Options	Default Value
Direction	Horizontal, Vertical	GX20/GP20/GP10: Horizontal GX10: Vertical
Trend clear	Off, On	Off
Trend line	Thick, Normal, Thin	Normal
Grid	Auto, 4, 5, 6, 7, 8, 9, 10, 11, 12	Auto

**Direction**

Set the trend waveform display direction.

**Trend clear**

Options	Description
On	Clears displayed waveforms when recording starts.
Off	Does not clear displayed waveforms when recording starts.

**Trend line**

Set the trend waveform line width.

**Grid**

Select the number of grid lines to display in the waveform display area of the trend display.

Options	Description
4 to 12	Displays a grid that divides the display width into 4 to 12 sections.
Auto	Divides the grid into the number of scale divisions of the first assigned channel of the group.

**Scale**

Setup Item	Selectable Range or Options	Default Value
Digit	Normal, Fine	Normal
Value indicator	Mark, Bar graph	Mark
Digit of mark	0 digit, 3 digits, 4 digits	3 digits

**Digit**

The number of displayed digits.

Fine: If scale values are two digits, you can change them to display three digits.

For example, if the scale range is 49.0 to 51.0 and you select **Normal**, the scale values are displayed using two digits (“49” for example). (▶ See the note in page 1-40 in section 1.2.3, “Setting the Display”.)

If you select **Fine**, the scale values are displayed using 3 digits as shown below.



**Value indicator**

Set the value indicator type.

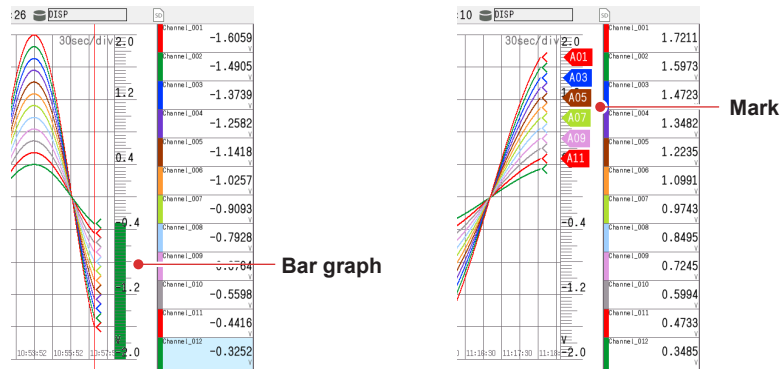

**Digit of mark**

Set the number of channel number digits to display for the digit of mark. If set to zero, the channel number is not displayed.

**Partial**

Setup Item	Selectable Range or Options	Default Value
On/Off	Off, On	Off

**On/Off**

Set this to **On** to enable the partial expanded display function. You can set this for AI channels, math channels, and communication channels.

By compressing a section of the waveform display range, the rest of the section is expanded.

In the example below, 0 V (boundary value) is moved to the 30% position of the display range (new boundary position). The 30% area below the boundary corresponds to “-6 V to 0 V” and 70% area above the boundary corresponds to “0 V to 6 V.”

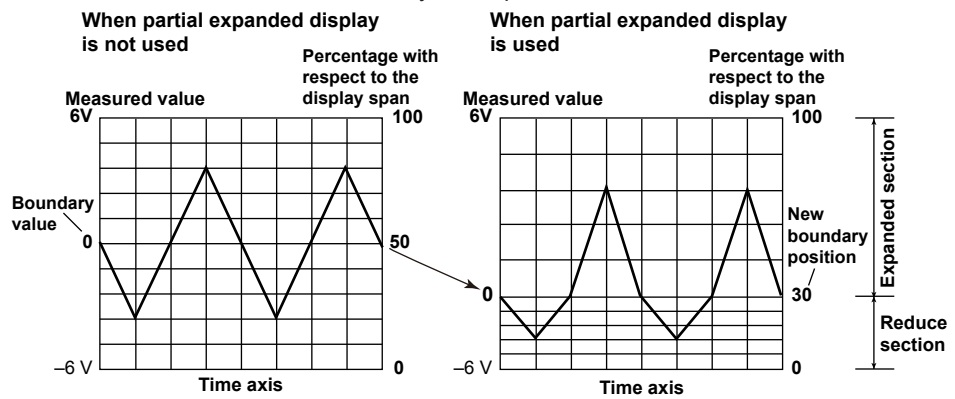

**Note**

Display span cannot be zoomed for channels whose partial expanded display is set to On.

### Message

Setup Item	Selectable Range or Options	Default Value
Write group	Common, Separate	Common
Power-fail message	Off, On	Off
Change message	Off, On	Off

#### Write group

Set the group to write messages to.

Options	Description
Common	Writes messages to all groups.
Separate	Writes messages to only the groups that are displayed.

#### Power-fail message

Set this to **On** to write power-fail messages.

When the GX/GP recovers from a power failure, a message is written.

Options	Description
On	Automatically writes the message when the GX/GP recovers from a power failure. Example message: ┌18:20:06 Power-fail message 2012/12/18 18:19:53┐ ↑   ↑ Recover time   Power-fail date/time
Off	Disables the feature.

#### Change message

Set this to **On** to record a message when the trend interval is changed.

When the trend interval is changed during recording, a message is written.

A message is also written when a portion of the settings is changed during recording if the advanced security function (/AS option) is in use.

Options	Description																								
On	Writes a message consisting of the time of change and the new trend interval when the trend interval is changed. Display example: "15:12 1min/div"  A message is written when any of the following settings is changed if the advanced security function is in use.																								
	<table border="1"> <tbody> <tr> <td>Alarm</td> <td>On/Off</td> </tr> <tr> <td></td> <td>Type</td> </tr> <tr> <td></td> <td>Value</td> </tr> <tr> <td></td> <td>Hysteresis</td> </tr> <tr> <td></td> <td>Logging</td> </tr> <tr> <td></td> <td>Output type</td> </tr> <tr> <td></td> <td>Output No.</td> </tr> <tr> <td>Alarm delay</td> <td>Alarm delay (hour/minute/second)</td> </tr> <tr> <td>Calibration correction</td> <td>Mode</td> </tr> <tr> <td></td> <td>Number of set points</td> </tr> <tr> <td></td> <td>Input value (1 to 12)</td> </tr> <tr> <td></td> <td>Output value (1 to 12)</td> </tr> </tbody> </table>	Alarm	On/Off		Type		Value		Hysteresis		Logging		Output type		Output No.	Alarm delay	Alarm delay (hour/minute/second)	Calibration correction	Mode		Number of set points		Input value (1 to 12)		Output value (1 to 12)
Alarm	On/Off																								
	Type																								
	Value																								
	Hysteresis																								
	Logging																								
	Output type																								
	Output No.																								
Alarm delay	Alarm delay (hour/minute/second)																								
Calibration correction	Mode																								
	Number of set points																								
	Input value (1 to 12)																								
	Output value (1 to 12)																								
Off	Disables the feature.																								

## 1.10.5 Setting Basic Screen Items

### Path

GX/GP: **MENU** key > **Browse** tab > **Setting** > Setting menu **Display settings** > **Screen display settings**

Web application: **Config.** tab > **Display settings** > **Screen display settings**

Hardware configurator: **Display settings** > **Screen display settings**

### Description

#### Bar graph

Setup Item	Selectable Range or Options	Default Value
Direction	Vertical, Horizontal	Vertical

#### Direction

Sets the bar graph display direction.

#### LCD

Setup Item	Selectable Range or Options	Default Value
Brightness	Brightness 1 to 6	GX20/GP20: Brightness 3 GX10/GP10: Brightness 4
View angle <sup>1</sup>	Upper, Lower	Upper

<sup>1</sup> Appears when GX10/GP10.

#### Brightness

Set the screen brightness. The larger the number, the brighter the screen.

#### View angle (GX10/GP10 Only)

Set the LCD view angle.

Options	Description
Upper	Makes it easier to view from above
Lower	Makes it easier to view from below

#### Backlight saver

Setup Item	Selectable Range or Options	Default Value
Mode	Off, Dimmer, Time-off	Off
Saver time <sup>1</sup>	1min, 2min, 5min, 10min, 30min, 1h	1h
Restore <sup>1</sup>	Key & Touch screen, Key & Touch screen & Alarm	Key & Touch screen & Alarm

<sup>1</sup> Appears when the mode is not set to **Off**.

#### Mode

Set the backlight saver mode.

Options	Description
Off	Disables the backlight saver
Dimmer	Dims the display if there is no operation for a given time.
Time-off	Turns the backlight off if there is no operation for a given time.

#### Saver time

Set the length of time that needs to elapse before the backlight saver operates. If the specified time elapses without any key or touch operation or alarm occurrence, the LCD backlight switches to the condition specified by **Mode**.

## 1.10 Setting Display Conditions

### Restore

Set the conditions for the LCD to recover from the backlight saver condition.

Options	Description
Key & Touch screen	The LCD returns to its original brightness when a key is pressed or a touch operation occurs.
Key & Touch screen & Alarm	The LCD returns to its original brightness when a key is pressed, a touch operation occurs, or an alarm occurs.

### Note

- If the backlight saver function has dimmed or turned off the backlight, pressing any key or touching the screen on the GX/GP will cause the backlight to return to its original brightness. This key or touch operation will not cause its original function to be executed.
- The brighter that you set the LCD, the faster its brightness will degrade and its color will change. We do not recommend that you use an unnecessarily high brightness setting for a prolonged period of time. We recommend that you use the backlight saver function.

### Monitor

Setup Item	Selectable Range or Options	Default Value
Display background	Black, White	White
Scroll time	5s, 10s, 20s, 30s, 1min	10s
Jump default display	Off, 1min, 2min, 5min, 10min, 20min, 30min, 1h	Off

#### Display background

Set the screen background color.

#### Scroll time

Set the scroll interval. The group will change in the following order: group 1, group 2, group 3, and so on.

You can set whether to scroll or not using the display menu (**Context** tab).

- For the procedure, see page 2-19 in section 2.2.2, “Switching the Group to Display”.

#### Jump default display

If there is no key or touch operation for the specified time, the screen returns to the standard display.

Options	Description
1min to 1h	The time until the screen switches.
Off	Disables the function.

### Calendar display

Setup Item	Selectable Range or Options	Default Value
1st weekday	Sunday, Monday	Sunday

#### 1st weekday

Set the first weekday of the calendar.

### Changing each value from monitoring

Setup Item	Selectable Range or Options	Default Value
On/Off	Off, On	Off

#### On/Off

Set this to **On** to enable users to change alarm values and control DO from the monitor displays (trend, digital, bar graph, and overview).

- For the procedure, see page 2-10 in section 2.2.1, “Displaying Measured Data Using Waveforms, Numeric Values, Bar Graph, or Custom Display (/CG option) (Trend, digital, bar graph, and custom displays)”.

## 1.11 Setting Measurement Conditions (Scan interval, A/D integrate, etc.)

Set the scan interval, A/D integrate, measurement groups, etc.

### 1.11.1 Setting the Scan Interval

When the measurement mode is Dual interval, see page 1-137 in section 1.13, "Configuring the Dual Interval Settings (Release number 4 and later)".

#### Path

GX/GP: **MENU** key > **Browse** tab > **Setting** > Setting menu **Measurement settings**

Web application: **Config.** tab > **Measurement settings** > **Scan interval**

Hardware configurator: **Measurement settings** > **Scan interval**

#### Description

#### Scan interval

Setup Item	Selectable Range or Options	Default Value
Scan interval	1ms <sup>4</sup> , 2ms <sup>4</sup> , 5ms <sup>4</sup> , 10ms <sup>4</sup> , 20ms <sup>4</sup> , 50ms <sup>4</sup> , 100ms <sup>1,3</sup> , 200ms <sup>1,3</sup> , 500ms <sup>1</sup> , 1s, 2s, 5s	1s <sup>2</sup>

- 1 Cannot be specified if an electromagnetic relay type (type suffix code -T1) analog input module is in use (configured).
- 2 2 s if an electromagnetic relay type analog input module is in use.
- 3 Cannot be specified if a low withstand voltage relay type (type suffix code -L1) analog input module is in use (configured).
- 4 You can set this when the measurement mode is High speed and a high-speed universal type module is detected

#### Scan interval

Set the scan interval. The scan intervals that you can set are displayed depending on the installed modules.

When the measurement mode is High speed and the scan interval is 1 ms or 2 ms, the following limitations apply to the number of valid channels of the high-speed AI module.

Scan interval	Channel limitations <sup>1</sup>
1 ms	All channels except channel 1 of each module are set to Skip.
2 ms	Channels 3 and 4 of each module are set to Skip.

- 1 Channels set to skip as a result of changing the scan interval are not changed from display group channel settings or recording channel settings.

## 1.11 Setting Measurement Conditions (Scan interval, A/D integrate, etc.)

### 1.11.2 Setting the Over-range Detection Method

#### Path

GX/GP: **MENU** key > **Browse** tab > **Setting** > Setting menu **Measurement settings**  
Web application: **Config.** tab > **Measurement settings** > **Over-range**  
Hardware configurator: **Measurement settings** > **Over-range**

#### Description

#### Over-range

Setup Item	Selectable Range or Options	Default Value
Value on over-range	Free, Over	Over

#### Value on over-range

Set how to detect over-range values on linearly scaled or square-rooted I/O channels. In either case, +over range occurs if the value excluding the decimal point exceeds 99999 and –over range if it falls below –999999.

Options	Description
Free	The value is set to –over range if the value is less than –5% of the measurable span range and +over range if the value is greater than 105%.
Over	The value is set to –over range if the value is less than –5% of the span setting (Linear scaling or , Square root span) and +over range if the value is greater than 105%. Example: If the linear scaling scale is 0.0 to 200.0, a value less than –10.0 results in a –over range, and a value greater than 210.0 results in a +over range.

### 1.11.3 Setting the Operation Mode of a Module

#### Path

GX/GP: **MENU** key > **Browse** tab > **Setting** > Setting menu **Measurement settings** > Select unit **Main unit** or **Unit1 to 6** > **Module 0 to 9**<sup>1</sup>  
Web application: **Config.** tab > **Measurement settings** > **Module settings**  
Hardware configurator: **Measurement settings** > **Module settings**  
<sup>1</sup> The module numbers that appear depend on the GX/GP module configuration.

#### Description

#### AI Modules

#### Operation mode

Setup Item	Selectable Range or Options	Default Value
Operation mode <sup>2</sup>	Not high-speed universal, 4-wire RTD/resistance type 2ch Only, Low noise mode; 10ch Normal mode	10ch Normal mode
	4-wire RTD/resistance type 2ch mode (low noise), 6ch mode (normal)	6ch Normal mode

<sup>2</sup> Fixed to 10ch mode for the electromagnetic relay type (Type suffix code -T1) or low withstand voltage relay type (Type suffix code -L1) analog input module.

#### Operation mode

Set the operation mode to use. For details on the operation modes, see the explanation.



**DI Modules**  
**Operation mode**

Setup Item	Selectable Range or Options	Default Value
Operation mode	Remote, Normal	Normal

**Operation mode**

Set the operation mode to use. For details on the operation modes, see the explanation.

**Explanation**

**2ch Mode and 6ch/10ch Mode (AI modules)**

In 10ch mode, measurement is possible on CH1 to CH10.  
 In 6ch mode, measurements on channels 1 to 6 are possible.  
 In 2ch mode, measurement is possible only on CH1 and CH2. (CH3 to CH6 or CH3 to CH10 are fixed to **Skip**.)  
 In 6ch/10ch mode, when the scan interval is set to 100 ms or 200 ms, the A/D integration time is fixed at 1.67 ms. This prevents power frequency noise from being eliminated, causing measured values to wobble (especially for temperature).  
 In 2ch mode, when the scan interval is 100 ms or 200 ms, the A/D integration time is 16.67 ms or 20 ms. This allows power frequency noise to be eliminated.  
 Note that the selectable A/D integration times vary depending on the 2ch/6ch/10ch mode and scan interval settings.

**Normal and Remote (DI modules)**

Specify Remote to use the DI module as a remote control input.  
 When there are multiple DI modules, only one of them can be set to Remote.  
 Remote can only be specified for a DI module or DI/DO module installed in the GX/GP main unit.  
 For normal DI input, specify **Normal**.

When using Event action, set to **Remote**.

► For details on report control using event action, see page 1-162 in section 1.19, "Configuring the Event Action Function".

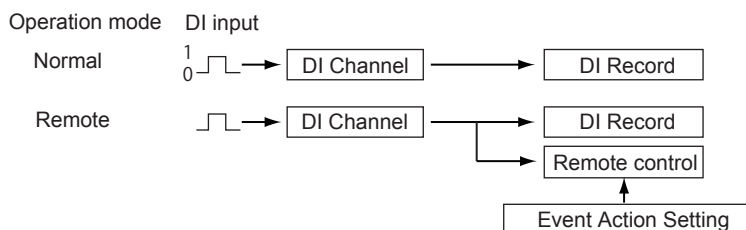

## 1.11 Setting Measurement Conditions (Scan interval, A/D integrate, etc.)

### 1.11.4 Setting the A/D Integral Time

This setting is not available on a high-speed AI or PID control module.

#### Path

GX/GP: **MENU** key > **Browse** tab > **Setting** > Setting menu **Measurement settings** > Select unit **Main unit** or **Unit1 to 6** > **Module 0 to 9**<sup>1</sup>

Web application: **Config.** tab > **Measurement settings** > **Module settings**

Hardware configurator: **Measurement settings** > **Module settings**

<sup>1</sup> The module numbers that appear depend on the GX/GP module configuration.

#### Description

##### A/D integrate

Setup Item	Selectable Range or Options	Default Value
A/D integrate	Auto, 50Hz, 60Hz, Common <sup>2</sup>	Auto

<sup>2</sup> **Common** appears when the scan interval is 500 ms (1 ms for low withstand voltage relay type) or longer.

##### A/D integrate

Set the module's A/D integration time. The available options appear depending on the scan interval setting.

Options	Description
Auto	<ul style="list-style-type: none"> <li>The GX/GP automatically detects the power supply frequency and sets the A/D integration time to 16.67 ms for 60 Hz and 20 ms for 50 Hz. However, if the module operation mode is 10ch or 6ch and the scan interval is 100 ms or 200 ms, the A/D integration time is fixed at 1.67 ms.</li> <li>If you are using the 24 VDC power supply on models with the 24 VDC/AC power supply (/P1 option), the A/D integration time is fixed to 20 ms (50 Hz).</li> <li>If the 12 VDC power supply (GP10-1J2W) is in use, the A/D integration time is fixed to 20 ms (50 Hz).</li> </ul>
50Hz	Sets the integration time to 20 ms.
60Hz	Sets the integration time to 16.67 ms.
Common	Sets the integration time to 16.67ms, 20ms, 36.67 ms or 100 ms. Integration time and scan interval by module

Type	Integration time	Scan interval	
		10ch mode, 6ch mode	2ch mode
Universal Current (mA) 4-wire RTD/resistance High withstand voltage	36.67ms	1s	
	100ms	2s or 5s	
Electromagnetic relay	16.67ms/20ms	1s	–
	36.67ms	2s	–
	100ms	5s	–
Low withstand voltage relay	36.67ms	2s	–
	100ms	5s	–

#### Explanation

##### Integration Time of the A/D Converter

The GX/GP uses an A/D converter to convert sampled analog signals to digital signals. By setting the integration time of the A/D converter to match the time period corresponding to one cycle of the power supply or an integer multiple of one cycle, the power supply frequency noise can be effectively eliminated.

Common (36.67 ms/100 ms) can be specified to effectively eliminate power supply frequency noise for both 50 Hz and 60 Hz.

## 1.11.5 Setting the Noise Rejection (High-speed AI, PID control module) (Release number 4 and later)

### Path

GX/GP: **MENU** key > **Browse** tab > **Setting** > Setting menu **Measurement settings** > Select unit **Main unit** or **Unit1 to 6** > **Module 0 to 9**<sup>1</sup>

Web application: **Config.** tab > **Measurement settings** > **Module operation settings**

Hardware configurator: **Measurement settings** > **Module operation settings**

<sup>1</sup> The module numbers that appear depend on the GX/GP module configuration.

### Description

#### Noise rejection

Setup Item	Selectable Range or Options	Default Value
Noise rejection	Auto, 50Hz, 60Hz, Common <sup>2</sup>	3

<sup>2</sup> **Common** appears when the scan interval is 100 ms or longer.

<sup>3</sup> Depends on the scan interval. Refer to the noise rejection modes that are available depending on the scan interval.

#### Noise rejection

Set the noise rejection. The available options appear depending on the scan interval setting. If you are using the 24 VDC power supply on models with the 24 VDC/AC power supply (/P1 option), the noise rejection is fixed to 50Hz.

If the 12 VDC power supply (GP10-1J2W) is in use, the noise rejection is fixed to 50Hz.

For PID control modules, the noise rejection is fixed to Common.

Options	Description
Auto	The GX/GP automatically detects the power supply frequency and rejects 50 Hz noise for 50 Hz or 60 Hz noise for 60 Hz. However, noise is not rejected if the scan interval is set to 1 ms, 2 ms, 5 ms, or 10 ms.
50Hz	50 Hz noise is rejected.
60Hz	60 Hz noise is rejected.
Common	50 Hz and 60 Hz noise is rejected simultaneously.

Noise rejection modes that are available depending on the scan interval

Scan interval	Available noise rejection modes	Default Value	Filter
1ms	Auto	Auto	None
2ms	Auto	Auto	None
5ms	Auto	Auto	None
10ms	Auto	Auto	None
20ms	Auto	Auto	50 Hz or 60 Hz auto selection
	50Hz		50Hz
	60Hz		60Hz
50ms	Auto	Auto	50 Hz or 60 Hz auto selection
	50Hz		50Hz
	60Hz		60Hz
100 ms to 5 s	Common	—	50 Hz and 60 Hz simultaneous rejection

### 1.11.6 Setting the Burnout Criteria (Release number 2 and later)

Set the upper and lower limits for determining burnout for when the range type is set to GS or GS (4-20mA).

#### Path

GX/GP: **MENU** key > **Browse** tab > **Setting** > Setting menu **Measurement settings** > Select unit **Main unit** or **Unit1 to 6** > **Module 0 to 9**<sup>1</sup>

Web application: **Config.** tab > **Measurement settings** > **Module operation settings**

Hardware configurator: **Measurement settings** > **Module operation settings**

<sup>1</sup> The module numbers that appear depend on the GX/GP module configuration.

#### Description

#### General signal

Setup Item	Selectable Range or Options	Default Value <sup>1</sup>
Lower limit of burnout	-20.0 to -5.0%	-10.0
Upper limit of burnout	105.0 to 120.0%	110.0

<sup>1</sup> When the PID control module, lower limit: -20.0, upper limit: 120.0.

#### Lower Limit of Burnout

Set the lower limit for determining burnout.

Set as a percentage of the specified span width.

#### Upper Limit of Burnout

Set the upper limit for determining burnout.

Set as a percentage of the specified span width.

### 1.11.7 Setting the Chattering Filter (DI module) for Pulse Input

You can set this filter on a DI module or DI/DO module when the GX/GP (/MT option) operation mode is set to Normal.

For details on the chattering filter of pulse input modules, see page 1-63 in section 1.4.1, "Setting the Range".

#### Path

GX/GP: **MENU** key > **Browse** tab > **Setting** > Setting menu **Measurement settings** > Select unit **Main unit** or **Unit1 to 6** > **Module 0 to 9** (DI or DIO module)<sup>1</sup>

Web application: **Config.** tab > **Measurement settings** > **Module operation settings**

Hardware configurator: **Measurement settings** > **Module operation settings**

<sup>1</sup> The module numbers that appear depend on the GX/GP module configuration.

#### Description

#### Chattering filter for pulse input

Setup Item	Selectable Range or Options	Default Value
On/Off	Off, On	On

#### Explanation

This filter prevents pulse count errors caused by chattering or noise. By default, the chattering filter for pulse input is set to On. This is because the pulse input of DI modules and DI/DO modules may be affected by noise. In normal situations, set the chattering filter for pulse input to On.

#### Note

Because the chattering filter for pulse input may not operate properly, update the version of the DI module or DI/DO module to R1.04.01 or later. ► See page 5-21 in section 5.1.8, "Updating the Firmware (Release number 2 and later)."

## 1.12 Setting Recording Conditions (Recording mode, recording interval, saving interval)

Set the type of data to record (display or event data), the recording interval, and the interval for saving measurement data files to an SD memory card.

When the measurement mode is Dual interval, the recording setting menu does not appear. For details on recording conditions, see page 1-137 in section 1.13, "Configuring the Dual Interval Settings (Release number 4 and later)".

### 1.12.1 Setting the Type of Data to Record (Display or event data) and Recording Conditions

#### Path

GX/GP: **MENU** key > **Browse** tab > **Setting** > Setting menu **Recording settings** > **Basic settings**

Web application: **Config.** tab > **Recording settings** > **Recording basic settings**

Hardware configurator: **Recording settings** > **Recording basic settings**

#### Description

#### Recording mode

Setup Item	Selectable Range or Options	Default Value
File type	Display <sup>2</sup> , Display + Event <sup>1 2</sup> , Event	GX10/GX20: Display GP10/GP20: Event

- 1 Does not appear for the advanced security function (/AS option) or multi-batch function (/BT option).
- 2 Does not appear when the measurement mode is High speed or Dual interval.

#### File type

Set the type of data to record.

When the measurement mode is High speed, this is fixed to Event.

Setup Item	Description
Display	Records display data
Display + Event	Records display and event data
Event	Records event data

#### Display Data, Trend Waveform

Setup Item	Selectable Range or Options	Default Value
Saving interval <sup>1</sup>	10min, 20min, 30min, 1h, 2, h, 3h, 4h, 6h, 8h, 12h, 1day, 2day, 3day, 5day, 7day, 14day, 31day	<sup>2</sup>

- 1 Does not appear when the file type is set to **Event**.
- 2 The minimum effective saving interval based on the trend interval of display data and the number of recording channels.

#### Note

- The maximum number of channels that the GX20/GP20 can record varies depending on the trend interval and file type (for the GX20-2/GP20-2).

Trend Interval (Unit: /div)	GX20-1/GP20-1		GX20-2/GP20-2	
	Display	Display + Event	Display	Display + Event
5s	100ch	100ch	200ch	100ch
10s	200ch	200ch	500ch	200ch
15s	500ch	500ch	1000ch	500ch
30s or more	500ch	500ch	1000ch	1000ch

- The GX10/GP10 can record up to 100 channels regardless of the trend interval or file type.

## 1.12 Setting Recording Conditions (Recording mode, recording interval, saving interval)

### Saving interval

Set the size of recording data per file. Recording data is divided at the specified file size. The options vary depending on the number of channels to record and the **Saving interval** setting.

Divided files can be linked using Universal Viewer. However, files whose recording was stopped cannot be linked.

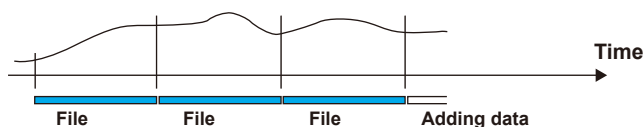

A file is also created in the following instances.

- When a file is created manually
- When recording is stopped
- When file creation is executed with the event action function
- After recovering from a power failure

### Trend Interval and Display Data Recording Interval

Trend Interval <sup>1</sup>	5 s	10 s	15 s	30 s	1min
Recording Interval	100 ms	200 ms	500 ms	1 s	2 s
Selectable range of file save interval	10 min to 12 hours	10 min to 1 days	10 min to 3 days	10 min to 7 days	10 min to 14 days
Trend Interval <sup>1</sup>	2 min	5 min	10 min	15 min	20 min
Recording Interval	4 s	10 s	20 s	30 s	40 s
Selectable range of file save interval	10 min to 14 days	10 min to 31 days	10 min to 31 days	10 min to 31 days	1 hour to 31 days
Trend Interval <sup>1</sup>	30 min	1 h	2 h	4 h	10 h
Recording Interval	1 min	2 min	4 min	8 min	20 min
Selectable range of file save interval	1 hour to 31 days	1 hour to 31 days	2 hour to 31 days	4 hour to 31 days	8 hour to 31 days

1 You cannot choose a recording interval that is shorter than the scan interval.

### Event data<sup>1</sup>

Setup Item	Selectable Range or Options	Default Value
Recording Interval	1ms <sup>7</sup> , 2ms <sup>7</sup> , 5ms <sup>7</sup> , 10ms <sup>7</sup> , 20ms <sup>7</sup> , 50ms <sup>7</sup> , 100ms <sup>4</sup> , 200ms <sup>4</sup> , 500ms <sup>4</sup> , 1s, 2s, 5s, 10s, 15s, 20s, 30s, 1min, 2min, 5min, 10min, 15min, 20min, 30min	1s <sup>5</sup>
Recording mode	Free, Single <sup>6</sup> , Repeat <sup>6</sup>	Free
Data length	2min, 5min, 10min, 20min, 30min, 1h, 2, h, 3h, 4h, 6h, 8h, 12h, 1day, 2day, 3day, 5day, 7day, 14day, 31day	<sup>2</sup>
Pre-trigger <sup>3</sup>	0%, 5%, 25%, 50%, 75%, 95%, 100%	0%
Trigger source operation <sup>3</sup>	Off, On	On

1 Appears when the file type is set to **Display + Event** or **Event**.

2 The minimum effective data length based on the recording interval of event data and the number of recording channels.

3 Appears when the recording mode is not set to **Free**.

4 Cannot be specified if an electromagnetic relay type (type suffix code -T1) analog input module is in use (configured).

5 2 s if an electromagnetic relay type analog input module is in use.

6 Does not appear for the advanced security function (/AS option) or multi-batch function (/BT option).

7 You can set this when the measurement mode is High speed or Dual interval is in use.

1.12 Setting Recording Conditions (Recording mode, recording interval, saving interval)

**Recording Interval**

Set the event data recording interval. You cannot choose a recording interval that is shorter than the scan interval.

You cannot choose a recording interval that is not an integer multiple of the scan interval.

**Note**

**When the measurement mode is set to Normal**

- The maximum number of channels that the GX20/GP20 can record varies depending on the recording interval and file type (for the GX20-2/GP20-2).

Recording Interval	GX20-1/GP20-1		GX20-2/GP20-2	
	Event	Display + Event	Event	Display + Event
100ms	100ch	100ch	500ch	100ch
200ms	200ch	200ch	500ch	200ch
500 ms or more	500ch	500ch	1000ch	500ch
1s or more	500ch	500ch	1000ch	1000ch

- The GX10/GP10 can record up to 100 channels regardless of the recording interval or file type.

**When the measurement mode is set to High speed or Dual interval**

There is a limit to the number of channels that can record at scan intervals shorter than 100 ms.

For the limitations, see the limitations provided in the following general specifications.

GX10/GX20 Paperless Recorder (panel mount type)

GS 04L51B01-01EN

GP10/GP20 Paperless Recorder (portable type)

GS 04L52B01-01EN

**Recording mode**

Set the mode for recording event data.

Options	Description
Free	Records data at all times
Single	Records data when the trigger condition is met
Repeat	Records data every time the trigger condition is met

• **Free**

Recording starts when you start it and stops when you stop it.

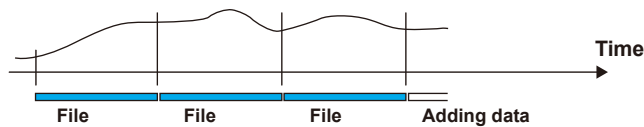

• **Single**

The GX/GP enters the trigger-wait state when you start recording. After a trigger event occurs, the GX/GP will record data for the specified time (data length) and stop. From this point, the GX/GP will not record even if the trigger condition is met.

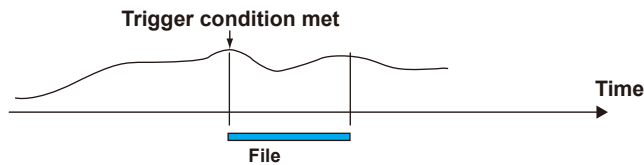

• **Repeat**

The GX/GP enters the trigger-wait state when you start recording. After a trigger event occurs, the GX/GP will record data for the specified time (data length) and stop. Then, it enters the trigger-wait state again and repeats recording for the specified time (data length) every time the trigger condition is met. To stop recording event data, stop the recording.

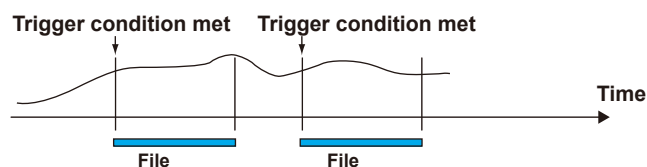

## 1.12 Setting Recording Conditions (Recording mode, recording interval, saving interval)

### Data length

Set the size of recording data per file. Recording data is divided at the specified file size. The selectable data lengths vary depending on the number of channels to record and the **Recording Interval** setting.

A file is also created in the following instances.

- When a file is created manually
- When recording is stopped
- When file creation is executed with the event action function
- After recovering from a power failure

Recording Interval <sup>1</sup>	1ms	2ms	5ms	10ms	20ms
Selectable range of data length	2 min to 10 min	2 min to 20 min	2 min to 1 hour	5 min to 2 hours	5 min to 4 hours
Recording Interval <sup>1</sup>	50ms	100 ms	200 ms	500 ms	1 s
Selectable range of data length	10 min to 8 hours	10 min to 1 days	10 min to 2 days	10 min to 3 days	10 min to 7 days
Recording Interval <sup>1</sup>	2 s	5 s	10 s	15 s	20 s
Selectable range of data length	10 min to 14 days	10 min to 31 days	10 min to 31 days	10 min to 31 days	10 min to 31 days
Recording Interval <sup>1</sup>	30 s	1 min	2 min	5 min	10 min
Selectable range of data length	1 hour to 31 days	1 hour to 31 days	1 hour to 31 days	1 hour to 31 days	1 hour to 31 days
Recording Interval <sup>1</sup>	15 min	20 min	30 min		
Selectable range of data length	1 hour to 31 days	1 hour to 31 days	1 hour to 31 day		

<sup>1</sup> You cannot choose a recording interval that is shorter than the scan interval.

### Pre-trigger

Set the range of data to record before the trigger point. Set this value as a percentage of the data length. If you do not want to record data before the trigger point, set this to 0%.

Pre-trigger enables you to record data before an event, such as an alarm.

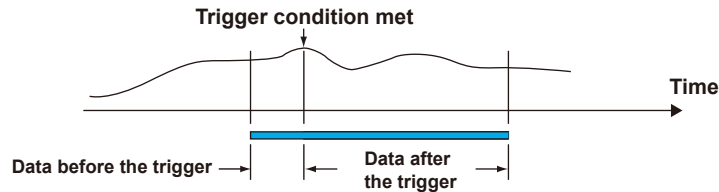

### Trigger source operation

In trigger mode, set this to **On** to apply triggers through touch operation.

#### Note

- In addition to operating from the screen, the event action function can be used to start recording.
- When you start recording, recording will start if the trigger condition is met.

## Record Confirmation Action (Release number 2 and later)

Setup Item	Selectable Range or Options	Default Value
Confirmation screen	Off, On	Off <sup>1 2</sup>

- <sup>1</sup> The default value when the multi-batch function (/BT) is set to **On** is **On** (fixed).
- <sup>2</sup> The default value is On when the advanced security function (/AS) is enabled.

### Confirmation Screen

Set this to **On** to display a record start or record stop confirmation screen when the START/STOP key is used.

If you set this to **Off**, recording starts or stops immediately when the START/STOP key is used.



**Explanation****Display Data and Event Data**

There are two file types: display data and event data.

Display data can be likened to the conventional recording on the chart sheet and are useful for long-term recording.

In the case of display data, the GX/GP records the maximum and minimum values from the measured values within each recording interval (Instantaneous data in each scan interval).

Event data is useful when you wish to record the measured data in detail.

In the case of event data, the GX/GP records the measured values at every recording interval (Instantaneous data in each scan interval).

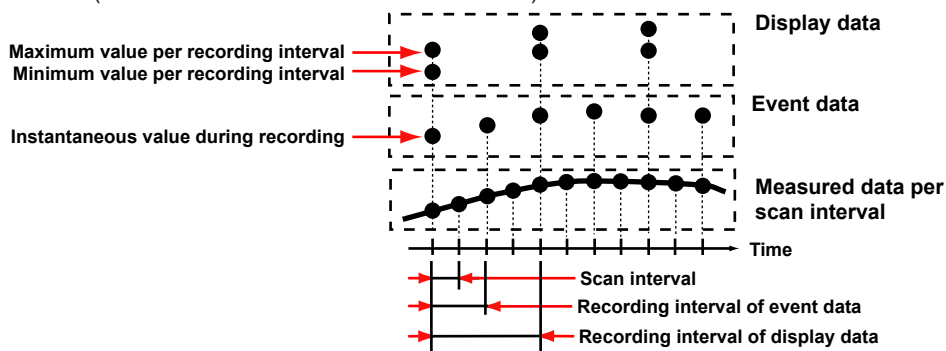

Refer to the examples below, and record data that suits your purpose.

Example 1: Continuously record the waveform data as with the conventional chart recorder.  
Record the display data.

Setup items  
File type: Display data

Example 2: Record waveform data under normal conditions but record details around the point of alarm occurrence when alarms occur.  
Continuously record display data and record event data when alarms occur.

Setup items  
File type: Display + Event data  
Recording mode: Single or Repeat

Example 3: Record the most-detailed data at all times.  
Record event data by specifying the recording interval.

Setup items  
File type: Event data  
Recording mode: Free

Example 4: No need to continuously record data. Record data only when alarms occur.  
Record event data only when alarms occur.

Setup items  
File type: Event data  
Recording mode: Single or Repeat

**1.12 Setting Recording Conditions (Recording mode, recording interval, saving interval)**

**Waveform Updating**

On the screen, 30 dots along the time axis is represented by a unit called division. The displayed waveform is updated at an interval corresponding to one dot. This interval is determined by the specified recording interval (which corresponds to one division referred to as the trend interval).

The table below shows the relationship between the trend interval and the speed of movement of waveforms on the screen.

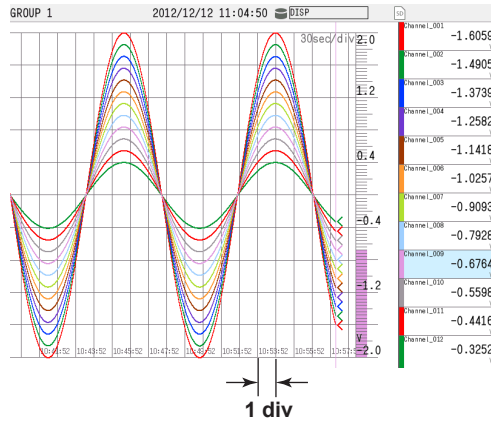

**Trend Interval and the Speed of Movement of Waveforms**

GX20/GP20

Recording Interval (Trend interval)	100ms <sup>2</sup>	200ms <sup>2</sup>	500ms <sup>2</sup>	1s <sup>2</sup>	2s <sup>2</sup>	3s <sup>3</sup>
Time corresponding to one dot (ms)	1	2	5	10	20	50
Speed of waveform movement (approximation in mm/h)	1107000	553500	221400	110700	55350	22140

Recording Interval (Trend interval)	5 s <sup>1</sup>	10 s <sup>1</sup>	15 s	30 s	1 min
Time corresponding to one dot (s)	0.1	0.2	0.5	1	2
Speed of waveform movement (approximation in mm/h)	11070	5535	2214	1107	554

Recording Interval (Trend interval)	2 min	5 min	10 min	15 min	20 min
Time corresponding to one dot (s)	4	10	20	30	40
Speed of waveform movement (approximation in mm/h)	277	111	55	37	28

Recording Interval (Trend interval)	30 min	1 h	2 h	4 h	10 h
Time corresponding to one dot (s)	60	120	240	480	1200
Speed of waveform movement (approximation in mm/h)	18	9.2	4.6	2.3	0.9

- 1 50 dots per division
- 2 100 dots per division
- 3 60 dots per division

## 1.12 Setting Recording Conditions (Recording mode, recording interval, saving interval)

GX10/GP10

Recording Interval (Trend interval)	100ms <sup>2</sup>	200ms <sup>2</sup>	500ms <sup>2</sup>	1s <sup>2</sup>	2s <sup>2</sup>	3s <sup>3</sup>
Time corresponding to one dot (ms)	1	2	5	10	20	50
Speed of waveform movement (approximation in mm/h)	653400	326700	130680	65340	32670	13068

Recording Interval (Trend interval)	5 s <sup>1</sup>	10 s <sup>1</sup>	15 s	30 s	1 min
Time corresponding to one dot (s)	0.1	0.2	0.5	1	2
Speed of waveform movement (approximation in mm/h)	6534	3267	1307	653	327

Recording Interval (Trend interval)	2 min	5 min	10 min	15 min	20 min
Time corresponding to one dot (s)	4	10	20	30	40
Speed of waveform movement (approximation in mm/h)	163	65	33	22	16

Recording Interval (Trend interval)	30 min	1 h	2 h	4 h	10 h
Time corresponding to one dot (s)	60	120	240	480	1200
Speed of waveform movement (approximation in mm/h)	11	5.4	2.7	1.4	0.5

- 1 50 dots per division
- 2 100 dots per division
- 3 60 dots per division

### Data Types

The GX/GP can record the following types of data.

If you are using the advanced security function (/AS option), see section 1.2.1, "Data Types," in the Advanced Security Function User's Manual (IM 04L51B01-05EN).

Data Type	Description
Display data	<ul style="list-style-type: none"> <li>• Waveform data displayed on the trend display. The measured data is recorded at the specified trend interval.</li> <li>• The minimum and maximum values among the measured data within the trend interval are saved.</li> <li>• A header string (shared with other files) can be written in the file.</li> <li>• Display data contains alarm and message information.</li> <li>• Data format: Binary (undisclosed), text</li> </ul>
Event data	<ul style="list-style-type: none"> <li>• Measured data that is recorded at the specified recording interval. There are two modes. One mode starts recording when a trigger occurs. The other mode records at all times.</li> <li>• A header string (shared with other files) can be written in the file.</li> <li>• Display data contains alarm and message information.</li> <li>• Data format: Binary (undisclosed), text</li> </ul>
Manual sampled data	<ul style="list-style-type: none"> <li>• Instantaneous value of the measured data when a manual sample operation is executed.</li> <li>• A header string (shared with other files) can be written in the file.</li> <li>• Data format: Text</li> </ul>
Report data (/MT option)	<ul style="list-style-type: none"> <li>• Hourly, daily, weekly, monthly, batch, daily custom report data. Report data is created at an interval that is determined by the report type (one hour for hourly reports, one day for daily reports, and so on).</li> <li>• A header string (shared with other files) can be written in the file.</li> <li>• Data format: Text</li> <li>• The data can be converted to Excel and PDF formats.</li> </ul>
Snapshot data (screen image data)	<ul style="list-style-type: none"> <li>• GX/GP screen image data.</li> <li>• The data can be saved to an SD memory card.</li> <li>• Data format: PNG</li> </ul>
Setting parameter	<ul style="list-style-type: none"> <li>• The setting parameters of the GX/GP.</li> <li>• Data format: Text</li> </ul>

**1.12 Setting Recording Conditions (Recording mode, recording interval, saving interval)**

**Flow of Data Recording and Storage**

Measured data is recorded once to the internal memory and then saved to the external storage medium.

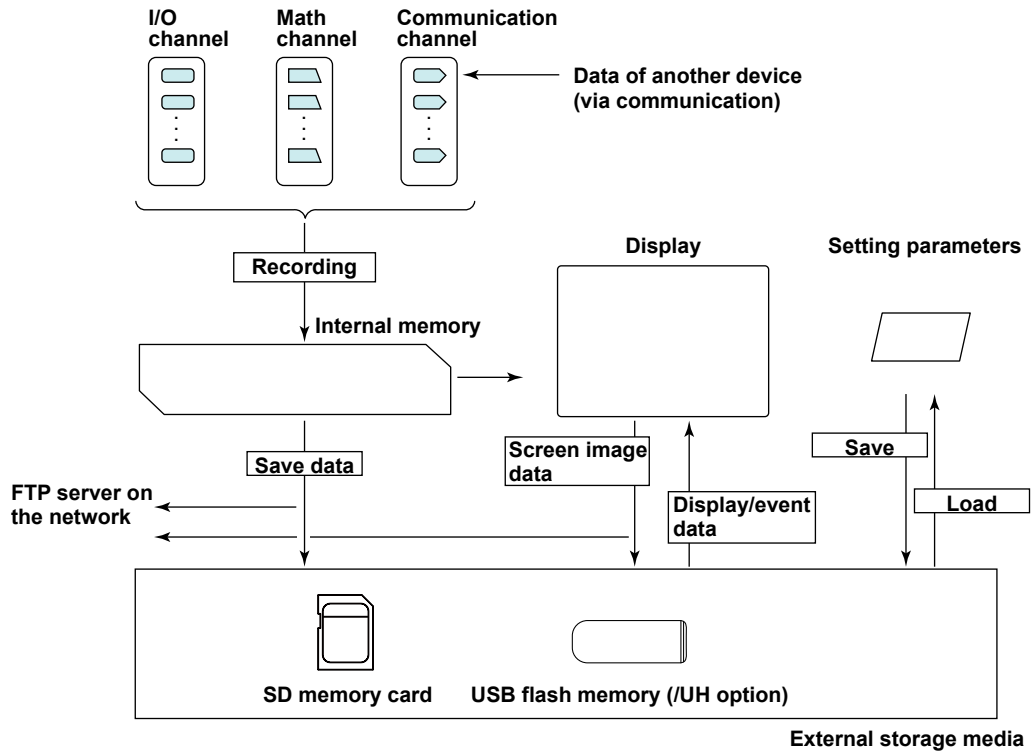

**Internal Memory**

Display data and event data are held in files in the internal memory. This data is also saved as files to a storage medium.

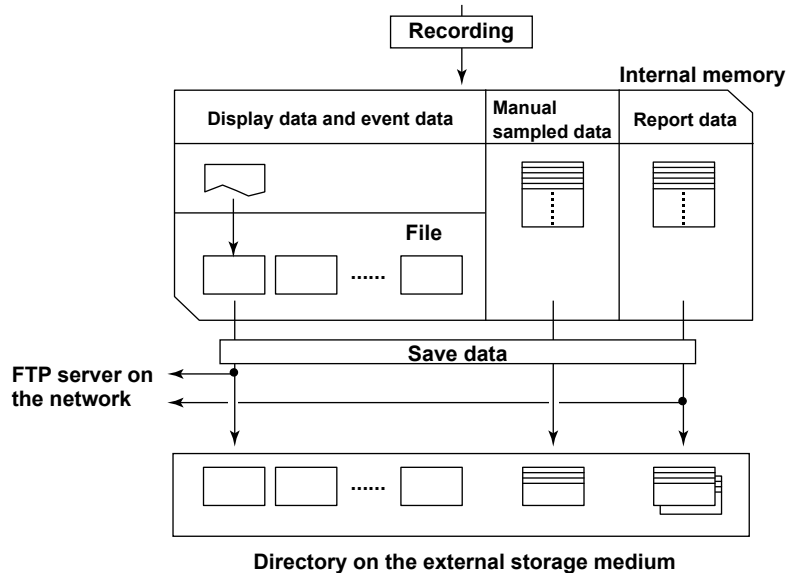

## 1.12.2 Configuring Recording Channels

### Path

GX/GP: **MENU** key > **Browse** tab > **Setting** > Setting menu **Recording settings** > **Recording channel settings**

Web application: **Config.** tab > **Recording settings** > **Recording channel settings**

Hardware configurator: **Recording settings** > **Recording channel settings**

### Description

Setup Item	Selectable Range or Options	Default Value
Display data, Trend waveform	AI, DI, pulse input, DO, AO, PID, math, communication channels	—
Event data	AI, DI, pulse input, DO, AO, PID, math, communication channels	—
Manual sample	AI, DI, pulse input, DO, AO, PID, math, communication channels	—

### Display data, Trend waveform

Set the channels for recording display data. Channels that you can specify are displayed. Even when recording mode is set to Event, if trend rate switching is set to On, set separate channels from the recording channels of event data.

### Event data

Set the channels for recording event data. Channels that you can specify are displayed. If you specify more than the number of recordable channels, the recording interval will automatically change to a setting that is possible.

### Manual sample

Set the channels for recording manual sampled data. Channels that you can specify are displayed.

Number of Recording Channels

Model	Maximum Number of Channels
GX10/GP10	50
GX20-1/GP20-1	50
GX20-2/GP20-2	100

Manual sampled data is recorded to internal memory. If the number of manual sampled data entries exceeds 400, the data is overwritten from the oldest entry.

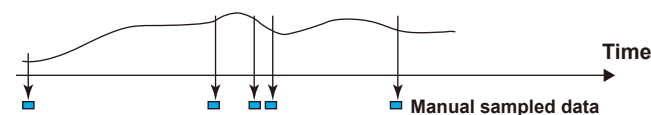

## 1.12 Setting Recording Conditions (Recording mode, recording interval, saving interval)

### Note

#### When the measurement mode is set to Normal

- The maximum number of channels that the GX20/GP20 can record varies depending on the recording interval and file type (for the GX20-2/GP20-2).

Display data

Recording Interval (Unit: /div)	GX20-1/GP20-1		GX20-2/GP20-2	
	Display	Display + Event	Display	Display + Event
5s	100ch	100ch	200ch	100ch
10s	200ch	200ch	500ch	200ch
15s	500ch	500ch	1000ch	500ch
30s or more	500ch	500ch	1000ch	1000ch

Event data

Recording Interval	GX20-1/GP20-1		GX20-2/GP20-2	
	Event	Display + Event	Event	Event + Display
100ms	100ch	100ch	500ch	100ch
200ms	200ch	200ch	500ch	200ch
500ms	500ch	500ch	1000ch	500ch
1s or more	500ch	500ch	1000ch	1000ch

- The GX10/GP10 can record up to 100 channels regardless of the recording interval or file type.

#### When the measurement mode is set to High speed or Dual interval

There is a limit to the number of channels that can record at recording intervals shorter than 100 ms.

For the limitations, see the limitations provided in the following general specifications.

GX/10/GX20 Paperless Recorder (panel mount type)

GS 04L51B01-01EN

GP10/GP20 Paperless Recorder (portable type)

GS 04L52B01-01EN

### Setting Channels through Swiping

In addition to tapping, you can swipe to set channels.

You can set the channels in the following two ways.

ON mode: The states of the channels change from not selected (off) to selected (on).

OFF mode: The states of the channels change from selected to not selected.

#### Procedure

#### ON mode

- 1 Tap a channel button.

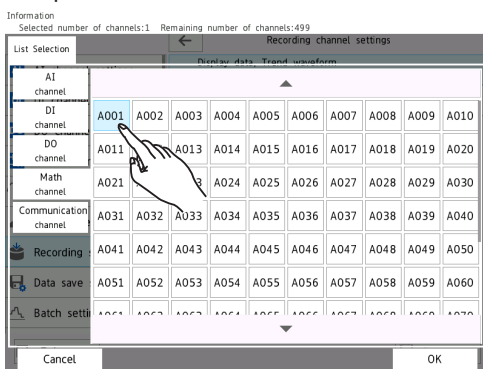

- 2 Swipe to set the channels.



## 1.12 Setting Recording Conditions (Recording mode, recording interval, saving interval)

- 3** Lift your finger from the last channel.  
The channels that you swiped through are confirmed.

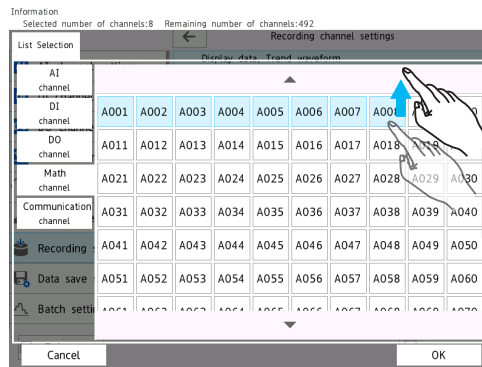

If flick before you lift your finger (before you confirm the settings), the channel states are reset. To finalize the settings, after you lift your finger, perform the following step.

- 4** Tap **OK**.  
The channels are finalized.

**Operation complete**

### OFF mode

Perform the same operation as you would for ON mode on the channels that are selected.

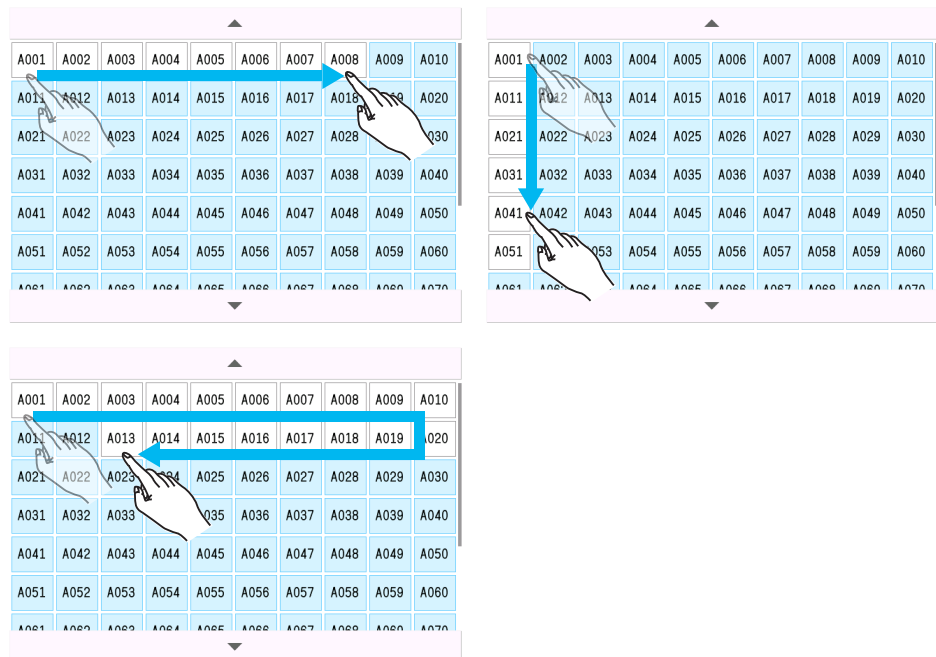



## 1.13 Configuring the Dual Interval Settings (Release number 4 and later)

These settings apply when the measurement mode is set to Dual interval.

### 1.13.1 Setting the Scan Interval

#### Path

GX/GP: **MENU** key > **Browse** tab > **Setting** > Setting menu **Dual interval settings** > **Scan interval**

Web application: **Config.** tab > **Dual interval settings** > **Scan interval**

Hardware configurator: **Dual interval** > **Scan interval**

#### Description

#### Scan interval

Setup Item	Selectable Range or Options	Default Value
Measurement group 1	1ms <sup>4,5</sup> 2ms <sup>4,5</sup> 5ms <sup>4,5</sup> 10ms <sup>4,5</sup> 20ms <sup>4,5</sup> 50ms <sup>4,5</sup> 100ms <sup>1,3,5</sup> 200ms <sup>1,3,5</sup> 500ms <sup>1,5</sup> 1s 2s 5s	1s <sup>2</sup>
Measurement group 2	100ms <sup>1,3,5</sup> 200ms <sup>1,3,5</sup> 500ms <sup>1,5</sup> 1s 2s 5s	2s

- 1 You cannot specify this value when an electromagnetic relay type module is used in the same measurement group.
- 2 2s when an electromagnetic relay type module is used in the same measurement group.
- 3 You cannot specify this value when a low withstand voltage relay type module is used in the same measurement group.
- 4 You can specify this value when only a high-speed universal type module is in use. However, can not settings 1 ms and 2 ms for GX10, GP10, GX20-1, GP20-1.
- 5 You cannot specify this value on sub unit (unit 1 to unit 6) modules.

#### Measurement group 1

Set the scan interval of measurement group 1. You can select from the scan intervals available depending on the installed module.

#### Measurement group 2

Set the scan interval of measurement group 2. You can select from the scan intervals available depending on the installed module.

#### Note

- You cannot set the scan intervals of measurement group 1 and measurement group 2 to the same value.
- The selectable range of scan intervals of each measurement group varies depending on the module assigned to the group. The longest scan interval among the assigned modules becomes the shortest scan interval that can be specified.

## 1.13 Configuring the Dual Interval Settings (Release number 4 and later)

### Master Scan Interval

Setup Item	Selectable Range or Options	Default Value
Measurement group number	Measurement group 1, measurement group 2	Measurement group 1

#### Measurement group number

Set the measurement group number with the scan interval that you want to use as the master scan interval.

## 1.13.2 Setting the Scan Interval of Each Module

### Path

GX/GP: **MENU** key > **Browse** tab > **Setting** > Setting menu **Dual interval settings** > **Scan interval** > Module scan interval **Main Unit** or **Unit 1 to 6** > **Module 0 to 9**<sup>1</sup>

Web application: **Config.** tab > **Dual interval settings** > **Scan interval**

Hardware configurator: **Dual interval settings** > **Scan interval**

<sup>1</sup> The module numbers that appear depend on the GX/GP module configuration.

### Description

#### Module 0 to Module 9

Setup Item	Selectable Range or Options	Default Value
Measurement group number	Measurement group 1, measurement group 2	—

#### Measurement group number

Set the scan group with the scan interval that you want the module to run at.

## 1.13.3 Setting the Recording Conditions

### Path

GX/GP: **MENU** key > **Browse** tab > **Setting** > Setting menu **Dual interval settings** > **Recording settings**

Web application: **Config.** tab > **Dual interval settings** > **Recording settings**

Hardware configurator: **Dual interval settings** > **Recording settings**

### Description

#### Recording mode

Setup Item	Selectable Range or Options	Default Value
File type	Event	Event

#### File type

Event data is recorded (fixed).

#### Event data (Measurement group 1)

Setup Item	Selectable Range or Options	Default Value
Recording interval	1ms, 2ms, 5ms, 10ms, 20ms, 50ms, 100ms, 200ms, 500ms, 1s, 2s, 5s, 10s, 15s, 20s, 30s, 1min, 2min, 5min, 10min, 15min, 20min, 30min	1s
Recording mode	Free, Single, Repeat	Free
Data length	2min, 5min, 10min, 20min, 30min, 1h, 2, h, 3h, 4h, 6h, 8h, 12h, 1day, 2day, 3day, 5day, 7day, 14day, 31day	1h

#### Recording interval

Set the event data recording interval. You cannot choose a recording interval that is shorter than the scan interval.

### Recording mode

Set the mode for recording event data.

Setup Item	Description
Free	Records data at all times
Single	Records data when the trigger condition is met
Repeat	Records data every time the trigger condition is met

### Data length

Set the size of recording data per file. Recording data is divided at the specified file size. The selectable data lengths vary depending on the number of channels to record and the **Recording Interval** setting.

A file is also created in the following instances.

- When a file is created manually
- When recording is stopped
- When file creation is executed with the event action function
- After recovering from a power failure

### Event data (Measurement group 2)

Setup Item	Selectable Range or Options	Default Value
Recording interval	100ms, 200ms, 500ms, 1s, 2s, 5s, 10s, 15s, 20s, 30s, 1min, 2min, 5min, 10min, 15min, 20min, 30min	2s
Recording mode	Free, Single, Repeat	Free
Data length	10min, 20min, 30min, 1h, 2h, 3h, 4h, 6h, 8h, 12h, 1day, 2day, 3day, 5day, 7day, 14day, 31day	1h

### Recording interval

This is the same as Measurement group 1.

### Recording mode

This is the same as Measurement group 1.

### Data length

This is the same as Measurement group 1.

### Record confirmation action

Setup Item	Selectable Range or Options	Default Value
Confirmation screen	Off, On	Off

### Confirmation screen

Set this to **On** to display a record start or record stop confirmation screen when the START/STOP key is used.

If you set this to **Off**, recording starts or stops immediately when the START/STOP key is used.

## 1.13.4 Configuring Recording Channels

### Path

GX/GP: **MENU** key > **Browse** tab > **Setting** > Setting menu **Dual interval settings** > **Recording channel settings**  
 Web application: **Config.** tab > **Dual interval settings** > **Recording channel settings**  
 Hardware configurator: **Dual interval settings** > **Recording channel settings**

### Description

#### Measurement group 1

Setup Item	Selectable Range or Options	Default Value
Event data	AI, DI, pulse input, AO, DO, math, communication channels	—

#### Event data

Set the channels for recording event data with measurement group 1. Channels that you can specify are displayed.  
 If you specify more than the number of recordable channels, the recording interval will be increased.

#### Measurement group 2

Setup Item	Selectable Range or Options	Default Value
Event data	AI, DI, pulse input, AO, DO, math, communication channels	—

#### Event data

Set the channels for recording event data with measurement group 2. Channels that you can specify are displayed.  
 If you specify more than the number of recordable channels, the recording interval will be increased.

#### Manual sample

Setup Item	Selectable Range or Options	Default Value
Manual sample	AI, DI, pulse input, AO, DO, math, communication channels	—

#### Manual sample

Set the channels for recording manual sampled data. Channels that you can specify are displayed.

Number of Recording Channels

Model	Maximum number of channels
GX10/GP10	50
GX20-1/GP20-1	50
GX20-2/GP20-2	100

## 1.14 Setting the Conditions for Saving Data Files

Set the conditions for saving data files.

### 1.14.1 Setting the Save Directory, File Header, and File Name

#### Path

GX/GP: **MENU** key > **Browse** tab > **Setting** > Setting menu **Data save settings**  
 Web application: **Config.** tab > **Data save settings**  
 Hardware configurator: **Data save settings**

#### Description

#### Save directory

Setup Item	Selectable Range or Options	Default Value
Directory name	Character string (up to 20 characters, <b>Aa#1</b> )	DATA0

#### Directory name

Set the name of the directory on the storage medium for saving data.

Characters that cannot be used: ' ; " \* / : < > ? \ |

Spaces are not allowed in the beginning or end of names.

Names cannot be all spaces.

Strings that cannot be used: AUX, CON, PRN, NUL, CLOCK, CLOCK\$, COM0 to COM9, LPT0 to LPT9

#### Note

Do not place a file with the same name as the directory name ("DATA0" by default) in the storage medium for saving data.

#### File header <sup>1</sup>

Setup Item	Selectable Range or Options	Default Value
Characters	Character string (up to 50 characters, <b>Aa#1</b> )	—

<sup>1</sup> If the multi-batch function (/BT option) is enabled, see the multi-batch function manual (IM 04L51B01-03EN).

#### Characters

Enter a header comment to write into data files.

#### Data file name <sup>1</sup>

Setup Item	Selectable Range or Options	Default Value
Structure	Date, Serial, Batch	Date
Identified strings	Character string (up to 16 characters, <b>Aa#1</b> )	—

<sup>1</sup> If the multi-batch function (/BT option) is enabled, see the multi-batch function manual (IM 04L51B01-03EN).

#### Structure

Sets the structure of the file name when saving data.

Options	Description
Date	Serial number + specified string + date The date reflects the date and time when recording was started to the relevant file.
Serial	Serial number + specified string
Batch	Serial number + batch (when using the batch function)

1.14 Setting the Conditions for Saving Data Files

Identified strings

Set the user-assigned character string.  
 Characters that cannot be used: ' ; " \* / : < > ? \ |

Explanation

File name

You can select what type of file name to use to save measured data to an SD memory card. The following three types are available. If you are using the advanced security function (/AS option), see section 1.2.8, "Saving Data to External Storage Medium," in the Advanced Security Function User's Manual (IM 04L51B01-05EN).

Structure	Description
Date	Display data Event data <sup>1</sup> Manual sampled data Snapshot data Alarm data  <div style="border: 1px solid black; padding: 2px; display: inline-block;">                         Serial   Specified string   Date   Extension                     </div> Example: 000123_AAAAAAAAAAA121231_174633.GDS
	Report data  <div style="border: 1px solid black; padding: 2px; display: inline-block;">                         Serial   Specified string   Date   Type   Extension                     </div> Example: 000123_AAAAAAAAAAA121231_174633HD.GRE
Serial	Display data Event data <sup>1</sup> Manual sampled data Snapshot data Alarm data  <div style="border: 1px solid black; padding: 2px; display: inline-block;">                         Serial   Specified string   Extension                     </div> Example: 000123_AAAAAAAAAAA.GDS
	Report data  <div style="border: 1px solid black; padding: 2px; display: inline-block;">                         Serial   Specified string   Type   Extension                     </div> Example: 000123_AAAAAAAAAAHD.GRE
Batch	Display data Event data <sup>1</sup>  <div style="border: 1px solid black; padding: 2px; display: inline-block;">                         Serial   Batch name   Extension                     </div> Example: 000123_BBBBBBBBBBBBBBBBBBBBBBBBBB.GDS
	Report data  <div style="border: 1px solid black; padding: 2px; display: inline-block;">                         Serial   Date   Type   Extension                     </div> Example: 000123_121231_174633HD.GRE
	Manual sampled data Snapshot data Alarm data  <div style="border: 1px solid black; padding: 2px; display: inline-block;">                         Serial   Date   Extension                     </div> Example: 000123_121231_174633.GMN

<sup>1</sup> For measurement group 2 when the measurement mode is set to Dual interval, "S" is attached to the front of the file name. Example when Structure is set to Date: S00123\_AAAAAAAAAAA121231\_174633.GEV

Item	Description																				
Serial	<div style="border: 1px solid black; padding: 2px; display: inline-block;">                         6-digit number + 1-character delimiter                     </div>																				
	6-digit number A number that indicates the file's order of occurrence. The number ranges from 000001 to 999999. If the number reaches 999999, it returns to 000000.																				
	1-character delimiter Starts with '_' and takes on the following values: A to Z and 0 to 9. If a file with the same name exists in the specified directory, the file is saved by changing the delimiter to prevent overwriting. Example: If a file named "000123_AAAAAAAAAAA.GDS" already exists, the file is saved to the name "000123AAAAAAAAAAAA.GDS."																				
Date	YYMMDD_hhmmss YY: Year (lower two digits), MM: Month, DD: Day hh: Hour, mm: minute, ss: Second <small>* The date reflects the date and time when recording was started to the relevant file.</small>																				
Specified string	AAAAAAAAAAAAAA Up to 16 alphanumeric characters can be used.																				
Batch name	BBBBBBBBBBBBBBBB***B Up to 41 alphanumeric characters can be used.																				
Type	H_, D_, W_, M_, HD, DW, DM, B_, C_ Report data types H_: Hourly, D_: Daily, W_: Weekly, M_: Monthly, HD: Hourly and daily, DW: Daily and weekly, DM: Daily and monthly, B_: Batch, C_: Daily custom																				
Extension	<table style="width: 100%; border-collapse: collapse;"> <tr> <td style="width: 50%;">Display data:</td> <td style="width: 50%;">GDS</td> <td style="width: 50%;">Display data (text):</td> <td style="width: 50%;">GTD</td> </tr> <tr> <td>Event data:</td> <td>GEV</td> <td>Event data (text):</td> <td>GTE</td> </tr> <tr> <td>Manual sampled data:</td> <td>GMN</td> <td>Report data:</td> <td>GRE</td> </tr> <tr> <td>Manual summary data:</td> <td>GAL</td> <td>Report data:</td> <td>xlsx or xlsxm (report template function)</td> </tr> <tr> <td>Snapshot data:</td> <td>png</td> <td>Report data:</td> <td>pdf (report template function)</td> </tr> </table>	Display data:	GDS	Display data (text):	GTD	Event data:	GEV	Event data (text):	GTE	Manual sampled data:	GMN	Report data:	GRE	Manual summary data:	GAL	Report data:	xlsx or xlsxm (report template function)	Snapshot data:	png	Report data:	pdf (report template function)
Display data:	GDS	Display data (text):	GTD																		
Event data:	GEV	Event data (text):	GTE																		
Manual sampled data:	GMN	Report data:	GRE																		
Manual summary data:	GAL	Report data:	xlsx or xlsxm (report template function)																		
Snapshot data:	png	Report data:	pdf (report template function)																		

## 1.14.2 Setting the Save Method to Media (Auto save or manual save) and Media FIFO

### Path

GX/GP: **MENU** key > **Browse** tab > **Setting** > Setting menu **Data save settings**

Web application: **Config.** tab > **Data save settings**

Hardware configurator: **Data save settings**

### Description

#### Media save

Setup Item	Selectable Range or Options	Default Value
Auto save	Off, On	On
Media FIFO <sup>1</sup>	Off, On	Off

<sup>1</sup> Appears when Auto save is set to **On**.

#### Auto save

Set this to **On** to automatically save measured data. To save measured data manually, set this to **Off**.

Options	Description
On	Automatically saves measured data to an SD memory card. Set this to <b>On</b> to use the media FIFO.
Off	Measured data is not saved automatically. Carry out a manual save operation to save measured data to an SD memory card or USB flash memory (/UH option).

#### Media FIFO

Set this to **On** to use media FIFO.

Options	Description
On	Enables media FIFO. Constantly retains the most recent data files in an SD memory card.
Off	Disables media FIFO. Replace the SD memory card if the free space on it drops low.

#### Note

If you are not using media FIFO, the SD memory card must have adequate free space to store all the data; otherwise, the GX/GP will not be able to save the data from the internal memory. Replace the SD memory card before the data in the internal memory is overwritten.

**Explanation**

**Internal Memory**

The recorded measured data is divided at a specific time interval (saving interval) and saved to files. If the internal memory is full or if the number of display data files and event data files exceeds 500 for GX10/GP10 and GX20-1/GP20-1 or 1000 for GX20-2/GP20-2, files are overwritten from the oldest file.

**Auto Save**

• **When Media FIFO Is Not in Use**

Keep the SD memory card inserted in the drive at all times. The data in the internal memory is automatically saved to the SD memory card.

If there is not enough free space on the SD memory card, the GX/GP cannot save the data in the internal memory to the SD memory card.

Replace the SD memory card and save the data before the data in the internal memory is overwritten.

• **Auto Save Timing**

Data Type	Description																		
Display data	The file is saved when the file is created.																		
Event data	Same as the display data.																		
Manual sampled data	The first time manual sample is executed, a manual sampled data file is created on the SD memory card. The data is appended to this file for each subsequent manual sample operation. A new file is created after manual sampled data is stored 100 times. ▶ For operating instructions, see page 2-75 in section 2.5.3, “Manually Saving Instantaneous Values of Measured Data (Manual sample)”.																		
Report data	The first time report data is generated, a report data file is created on the SD memory card and report data is stored. The report data is appended to this file every time a report is created. <b>Dividing of the report files</b> The appending of the report data to the file is stopped at a specified time, and subsequent reports are saved to a new file. The file is divided in the unit shown in the table below. Also, when recording is stopped, all report files are divided. <b>Report template</b> Every time a report file is divided, a report file is created according to the specified template format such as an XML spreadsheet format or PDF format. The report file can also be printed. ▶ For the setup procedure, see page 1-151 in section 1.16, “Configuring the Report Function (/MT option)”.																		
Report kind	<table border="1" style="width: 100%; border-collapse: collapse;"> <thead> <tr> <th style="text-align: left;">Report File</th> <th style="text-align: left;">Separate</th> <th style="text-align: left;">Combine</th> </tr> </thead> <tbody> <tr> <td>Hourly and daily reports</td> <td><input type="checkbox"/> a file for each daily report <input type="checkbox"/> hourly reports for a day</td> <td><input type="checkbox"/> hourly reports for a day and a daily report</td> </tr> <tr> <td>Daily and weekly reports</td> <td><input type="checkbox"/> a file for each weekly report <input type="checkbox"/> daily reports for a week</td> <td><input type="checkbox"/> daily reports for a week and a weekly report</td> </tr> <tr> <td>Daily and monthly reports</td> <td><input type="checkbox"/> a file for each monthly report <input type="checkbox"/> daily reports for a month</td> <td><input type="checkbox"/> daily reports for a month and a monthly report</td> </tr> <tr> <td>Batch reports</td> <td><input type="checkbox"/> a file for each recording start/stop operation The file will be divided if the number of data entries exceeds 200.</td> <td><input type="checkbox"/> a file for each recording start/stop operation The file will be divided if the number of data entries exceeds 200.</td> </tr> <tr> <td>Day custom</td> <td><input type="checkbox"/> a file for each file creation unit</td> <td><input type="checkbox"/> a file for each file creation unit</td> </tr> </tbody> </table>	Report File	Separate	Combine	Hourly and daily reports	<input type="checkbox"/> a file for each daily report <input type="checkbox"/> hourly reports for a day	<input type="checkbox"/> hourly reports for a day and a daily report	Daily and weekly reports	<input type="checkbox"/> a file for each weekly report <input type="checkbox"/> daily reports for a week	<input type="checkbox"/> daily reports for a week and a weekly report	Daily and monthly reports	<input type="checkbox"/> a file for each monthly report <input type="checkbox"/> daily reports for a month	<input type="checkbox"/> daily reports for a month and a monthly report	Batch reports	<input type="checkbox"/> a file for each recording start/stop operation The file will be divided if the number of data entries exceeds 200.	<input type="checkbox"/> a file for each recording start/stop operation The file will be divided if the number of data entries exceeds 200.	Day custom	<input type="checkbox"/> a file for each file creation unit	<input type="checkbox"/> a file for each file creation unit
Report File	Separate	Combine																	
Hourly and daily reports	<input type="checkbox"/> a file for each daily report <input type="checkbox"/> hourly reports for a day	<input type="checkbox"/> hourly reports for a day and a daily report																	
Daily and weekly reports	<input type="checkbox"/> a file for each weekly report <input type="checkbox"/> daily reports for a week	<input type="checkbox"/> daily reports for a week and a weekly report																	
Daily and monthly reports	<input type="checkbox"/> a file for each monthly report <input type="checkbox"/> daily reports for a month	<input type="checkbox"/> daily reports for a month and a monthly report																	
Batch reports	<input type="checkbox"/> a file for each recording start/stop operation The file will be divided if the number of data entries exceeds 200.	<input type="checkbox"/> a file for each recording start/stop operation The file will be divided if the number of data entries exceeds 200.																	
Day custom	<input type="checkbox"/> a file for each file creation unit	<input type="checkbox"/> a file for each file creation unit																	



- **When Media FIFO Is in Use**

If not enough free space is available when saving a new data file to the SD memory card, files are deleted in order from the oldest data update date/time to save the new file. This operation is referred to as FIFO (First In First Out).

When saving the data files automatically, you can save the data so that the most recent data files are constantly retained in the SD memory card. This method allow you to use the GX/GP continuously without having to replace the SD memory card.

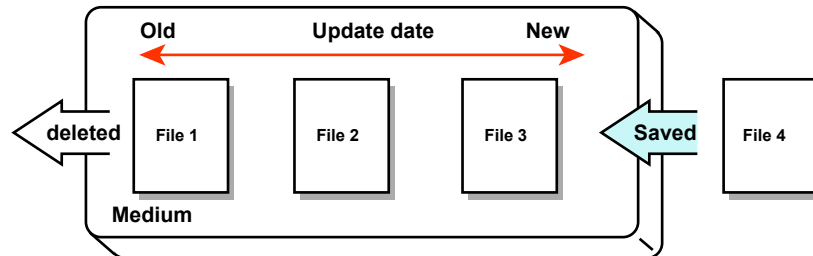

### Media FIFO Save Operation

- The FIFO operation is carried out only when the following files are saved automatically. It is not carried out when files are saved to the save destination directory through another method.
  - Display data files, event data files, report data files, manual sample data files, and snapshot data files
- Files that are deleted
  - All the files in the save destination directory are applicable to be deleted. However, the following files are excluded.
    - Hidden files, read-only files, files in the subdirectory within the save destination directory
- The most recent 1000 files are retained. If the number of files in the save destination directory exceeds 1000, the number of files is held at 1000 by deleting old files even if there is enough free space.
- If there are more than 1000 files already in the save destination directory, one or more files are always deleted before saving the new file. The number of files is not kept within 1000 in this case.

## 1.14 Setting the Conditions for Saving Data Files

### Manual Save (Collectively storing unsaved data)

Unsaved data in the internal memory is stored in unit of files to the external storage medium (SD memory card or USB flash memory) when an external storage medium is inserted and a given operation is carried out.

When using manual save, it is important that you save the data in the internal memory to the external storage medium before the data is overwritten. Determine the usage condition of the internal memory and save the data to the external storage medium at appropriate times.

- For details on the manual save operation, see page 2-74 in section 2.5.2, “Manually Saving Measured Data (Collectively saving unsaved data)”.

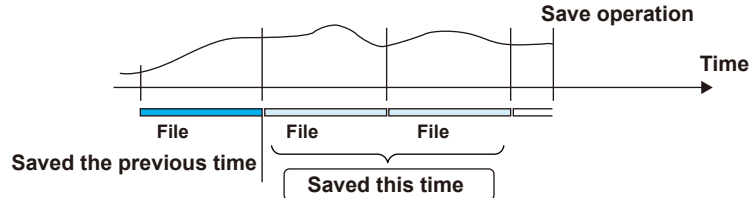

### Saving Data from the Screen

You can carry out the following data save operations regardless of whether auto save or manual save is used.

Data Storage	Description
All save	Collectively saves all the data in the internal memory.
Selective save	Saves the specified display data or event data file.
Manual sampled data save	Collectively saves all the manual sampled data in the internal memory.
Report data save	Collectively saves all the report data in the internal memory.

### Save Destination

You can select an SD memory card or USB flash memory (/UH option).

### Data Save Destination Directory

Creates a directory with the name of the data save destination directory name with the date/time added and saves the data.

Directory name: “Specified string”\_YYMMDD\_HHMMSS

Example: If the data is saved at 17 hours 6 minutes 42 seconds on December 30, 2012, the data is saved to a directory named “DATA0\_121230\_170642.”

“DATA0” is the specified string.

### Note

The number of directories that you can create on the external storage medium varies depending on the length of the directory names. If the length of the “specified string” is 5 characters, approximately 170 directories can be created. If it is 20 characters, approximately 120 directories can be created. An error occurs if you try to create directories exceeding this limit.

### 1.14.3 Setting the File Format of Display Data and Event Data

#### Path

GX/GP: **MENU** key > **Browse** tab > **Setting** > Setting menu **Data save settings**  
 Web application: **Config.** tab > **Data save settings**  
 Hardware configurator: **Data save settings**

#### Description

#### File format

Setup Item	Selectable Range or Options	Default Value
Display/Event data	Binary, Text <sup>1</sup>	Binary

<sup>1</sup> Does not appear for the advanced security function (/AS option).

#### Display/Event data

Set the file format of display data and event data.

Text format is TSV (tab separated).

When the measurement mode is set to Dual interval or High speed, this is fixed to **Binary**.

## 1.15 Configuring the Batch Function

Set the batch function. You can add batch information to display data and event data files. You can manage display data and event data files using batch information.

### 1.15.1 Configuring the Batch Function (Lot-No. digit and Auto increment)

#### Path

GX/GP: **MENU** key > **Browse** tab > **Setting** > Setting menu **Batch settings**  
Web application: **Config.** tab > **Batch settings** > **Batch function**  
Hardware configurator: **Batch settings** > **Batch function**

#### Description

##### Batch function

Setup Item	Selectable Range or Options	Default Value
On/Off	Off, On	Off
Lot-No. digit <sup>1</sup>	Off, 4, 6, 8	6
Auto increment <sup>1</sup>	Off, On	On

<sup>1</sup> Appears when the batch function is set to **On**.

##### On/Off

Set this to **On** to use the batch function.

##### Lot No.

Set the number of digits of lot numbers. To disable lot numbers, set this to **Off**.

##### Auto increment

Options	Description
On	Automatically sets the lot number of the next measurement to the current lot number + 1.
Off	Turns auto increment off.

### 1.15.2 Setting Batch Text

#### Path

GX/GP: **MENU** key > **Browse** tab > **Setting** > Setting menu **Batch settings** > Batch text  
**Batch text**  
Web application: **Config.** tab > **Batch settings** > **Batch text**  
Hardware configurator: **Batch settings** > **Batch text**

#### Description

Setup Item	Selectable Range or Options	Default Value
Text field number	1 to 24	1

##### Text field number

Select the text field number to assign text to.

##### Text field

Setup Item	Selectable Range or Options	Default Value
Title of field	Character string (up to 20 characters, <b>Aa#1</b> )	—
Characters	Character string (up to 30 characters, <b>Aa#1</b> )	—

**Title of field**

Set the title for the text field number you selected.

**Characters**

Set the characters for the text field number you selected.

### 1.15.3 Setting the Recording Start Screen (Release number 3 and later)

**Path**

GX/GP: **MENU** key > **Browse** tab > **Setting** > Setting menu **Batch settings**

Web application: **Config.** tab > **Batch settings** > **Batch function**

Hardware configurator: **Batch settings** > **Batch function**

**Description****Recording start screen**

Setup Item	Selectable Range or Options	Default Value
Recording start screen	Batch comment, Batch Text field	Batch Text field

**Recording start screen**

Set whether to display a text field or batch comment on the recording start screen when recording is started.

Recording start screen is a setting for the GX/GP.

On the Web application, Batch comment and Batch Text field are displayed.

**Explanation****Batch function**

- **Batch Number and Lot Number**

Display data and event data files can be identified by their “batch number-lot number” (hereinafter referred to as batch name). The lot number does not have to be specified.

- Batch number (up to 32 characters)
- Lot number (up to 8 digits)

- **Automatic Increment of the Lot Number**

The lot number can be automatically incremented when the recording is stopped.

- **Text Field**

You can enter text fields into a file. There are 24 available text fields. Each text field consists of the following:

- Field title (up to 20 characters)
- Field string (up to 30 characters)

You can use the touch screen to display text fields on the GX/GP screen.

- **Batch Comment**

You can enter up to three comments in a file. You can enter each comment once during recording.

Comment 1, Comment 2, and Comment 3 (up to 50 characters each)

## 1.15 Configuring the Batch Function

---

### Using the Batch Function

You can enter text in measurement data files.

See the figure below.

For example, you can enter the operator name and administrator name in text fields.

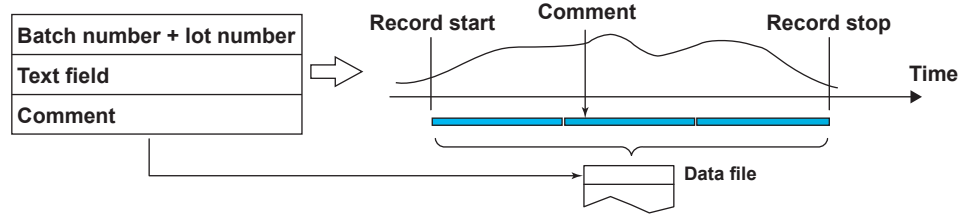

► For the procedure, see page 2-4 in section 2.1.2, "Using the Batch Function".

## 1.16 Configuring the Report Function (/MT option)

Set the report function.

When the measurement mode is set to High speed or Dual interval, there is a limit to the number of report channels at scan intervals shorter than 100 ms. For details, see the following general specifications.

GX/10/GX20 Paperless Recorder (panel mount type)  
GP10/GP20 Paperless Recorder (portable type)

GS 04L51B01-01EN  
GS 04L52B01-01EN

### 1.16.1 Setting the Report Type, Creation Time, Data Type, Etc.

#### Path

GX/GP: **MENU** key > **Browse** tab > **Setting** > Setting menu **Report settings** > **Basic settings**

Web application: **Config.** tab > **Report settings** > **Report basic settings**

Hardware configurator: **Report settings** > **Report basic settings**

#### Description

#### Type

Setup Item	Selectable Range or Options	Default Value
Type	Off, Hourly + Daily, Daily + Weekly, Daily + Monthly, Batch, Daily custom	Off

#### Type

Set the kind of report to create.

Options	Description
Off	Disables the report function.
Hourly + Daily	Creates hourly and daily reports. Hourly report: Creates report data every hour on the hour for the previous one hour. Daily report: Creates report data every day at a specified time for the previous one day.
Daily + Weekly	Creates Daily and weekly reports. Weekly report: Creates report data every week at a specified time at a specified day of the week for the previous one week.
Daily + Monthly	Creates Daily and Monthly reports. Monthly report: Creates report data every month at a specified time at a specified day for the previous one month.
Batch	Creates a report in unit of batches.
Daily custom	Creates daily reports by dividing it at the specified time intervals.

#### Creation time<sup>1</sup>

Setup Item	Selectable Range or Options	Default Value
Day	1 to 28	1
Day of week	Sunday, Monday, Tuesday, Wednesday, Thursday, Friday, Saturday	Sunday
Hour	0 to 23	0
Minute	0 to 59	0
Save interval <sup>2</sup>	2min, 3min, 4min, 5min, 10min, 15min, 30min, 1h	10min
File creation interval	4h, 6h, 8h, 12h, 24h	4h

<sup>1</sup> Appears when the kind of report is not set to **Off**.

<sup>2</sup> Appears when the type is set to Batch or Daily custom.

## 1.16 Configuring the Report Function (/MT option)

Depending on the kind of report, set the items with check marks in the table below.

Setup Item	Kind				
	Hourly + Daily	Daily + Weekly	Daily + Monthly	Batch	Daily custom
Day			✓		
Day of week		✓			✓
Hour	✓	✓	✓		✓
Minute					✓
Save interval				✓	✓
File creation interval					✓

### Day, Day of week, Hour, Minute

Set the day or day of week and the time to create reports.

### Save interval (for Batch and Day custom)

Set the data recording interval.

### File creation interval (for Day custom)

Set the time interval for dividing files.

## Data type

Setup Item	Selectable Range or Options	Default Value
Report 1 to 5	Ave, Max, Min, Sum, Inst	—

### Report 1 to 5

Set the data type to output as reports.

Options	Description
Ave	Outputs average values.
Max	Outputs maximum values.
Min	Outputs minimum values.
Sum	Outputs sum values.
Inst	Outputs instantaneous values.

## File type<sup>1</sup>

Setup Item	Selectable Range or Options	Default Value
File type	Separate/Combine	Combine

<sup>1</sup> Appears when the Type is not set to **Batch** or **Daily custom**.

### File type

Set this item when creating two types of reports such as daily report and monthly report.

Options	Description
Separate	Saves each type of report to a separate file. ► For information about how files are divided, see page 1-143 in section 1.14.2, "Setting the Save Method to Media (Auto save or manual save) and Media FIFO".
Combine	Saves the report data of two types in a single file.

## Report template output

Setup Item	Selectable Range or Options	Default Value
Excel file	Off, On	Off
PDF file	Off, On	Off
Printer	Off, On	Off

### Excel file

Set this to **On** to output in Excel format.



**PDF file**

Set this to **On** to output in PDF format.

**Printer**

Set this to **On** to output to a printer.

- ▶ For instructions on how to set the output destination printer, see page 1-213 in section 1.23.7, “Setting the Printer Output Conditions”.

**Electronic Signature (Release number 2 and later)**

Setup Item	Selectable Range or Options	Default Value
PDF electronic signature	Off, On	Off

**PDF Electronic Signature**

Set this to **On** to electronically sign a PDF file.

To use electronic signature, you need to create a key and a certificate.

- ▶ See page 1-260 in section 1.30, “Configuring Key Creation, Certificate Management, and Encryption/Certificate (SSL communication, PDF electronic signature) (Release number 2 and later)”.

**Text file (release number 3 and later) <sup>1</sup>**

Setup Item	Selectable Range or Options	Default Value
Attach batch information	Off, On	Off

<sup>1</sup> Appears when the batch function is set to **On**.

**Attach batch information**

Set this to **On** to output text data of report files by attaching batch information.

If the file division mode is **Separate**, batch information is attached to each file.

**Note**

If the multi-batch function (/BT option) is enabled, batch information cannot be attached. Batch information cannot be output in report template output (Excel file, PDF file, printer output).

**Explanation****Report Data Values**

The range of report data values is from  $-9999999$  to  $99999999$  excluding the decimal point.

**Saving the Report Data**

Report data is saved to the internal memory. If the number of report data entries exceeds 800, the data is overwritten from the oldest entry.

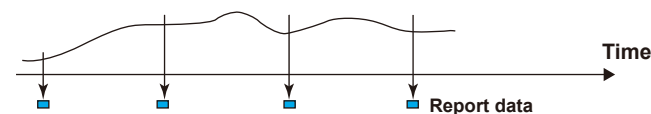
**Day custom**

You can create daily reports by dividing files at the specified time interval (file creation interval).

For example, in a three-shift system, you can set the file creation interval to 8 hours to create a file for each shift.

## 1.16.2 Setting the Channels to Output Reports

### Path

GX/GP: **MENU** key > **Browse** tab > **Setting** > Setting menu **Report settings** > **Report channel settings**

Web application: **Config.** tab > **Report settings** > **Report channel settings**

Hardware configurator: **Report settings** > **Report channel settings**

### Description

Setup Item	Selectable Range or Options	Default Value
Report channel number	GX20/GP20: 1 to 60 GX10/GP10: 1 to 50	1

\* There are limits to the number of report channels depending on the measurement mode and scan interval. For details, see "Explanation."

#### Report channel number

Select the report channel number. The GX/GP generates reports in order by this number.

#### Report channel

Setup Item	Selectable Range or Options	Default Value
Channel type	I/O channel, Math channel, Communication channel, Off	—
Channel no <sup>1</sup>	Channels that you can set	—
Sum scale <sup>1</sup>	Off, /s, /min, /h, /day	—

<sup>1</sup> Appears when the channel type is not set to **Off**.

#### Channel type

Set the channel type to assign to the report channel.

#### Channel no

Set the channel number to assign to the report channel. All channels can be assigned, but reports are not created for channels set to **Skip** or **Off** even if they are assigned.

#### Sum scale

Set the sum scale to match the unit of the measured values.

Example: If the unit of the measured value is "m<sup>3</sup>/min," select **/min**.

Off: The measured data is summed as-is once per scan interval.

**Explanation****Unit of Sum Computation**

In sum computation, data is summed over the scan interval. However, for flow values that have units /s, /min, /h, or /day a simple summation results in the actual value not matching the computed result, because the scan interval and the unit of the input values are different. In such cases, set the sum scale to match the unit of the input value. In effect, the sum value with the same unit as that of the input value is computed.

For example, if the scan interval is 2 s, and the input value is 100 m<sup>3</sup>/min, a simple summation would add 100 every 2 s resulting in 3000 after one minute. However, if the sum scale is set to /min, then 2 s/60 s is multiplied every scan interval before the value is added giving a result that has an m<sup>3</sup> unit.

The following converting equations are used to compute the sum. The scan interval unit is seconds.

Off:  $\Sigma(\text{measured data every scan interval})$

/s:  $\Sigma(\text{measured data every scan interval}) \times \text{scan interval}$

/min:  $\Sigma(\text{measured data every scan interval}) \times \text{scan interval}/60$

/h:  $\Sigma(\text{measured data every scan interval}) \times \text{scan interval}/3600$

/day:  $\Sigma(\text{measured data every scan interval}) \times \text{scan interval}/86400$

**Report Processing when the Measurement Mode Is Set to Dual Interval**

Report computation is performed at the scan interval of each measurement group. For example, if a channel of measurement group 1 is assigned to a report channel, computation on that report channel is performed at the scan interval of measurement group 1. A single report file will be created.

**Report Processing When the Measurement Mode Is Set to High Speed**

Report computation is performed at the scan interval.

**Maximum Number of Report Channels**

The following table shows the maximum number of report channels depending on the measurement mode.

Model	Measurement Mode		
	Normal	High speed	Dual interval
GX10/GP10	50	50	25
GX20-1/GP20-1	60	60	30
GX20-2/GX20-2	60	60	30

## 1.17 Using the Report Template Function (/MT option)

You can create report templates and use them to automatically create custom report files. Load a report template file that you have created into the GX/GP internal memory. The GX/GP will automatically create report files using the report template file. A report template file can be used to create report files in Excel format, create report files in PDF format, and print reports on a printer connected over the LAN. The GX/GP can handle template files that are 1 MB or smaller.

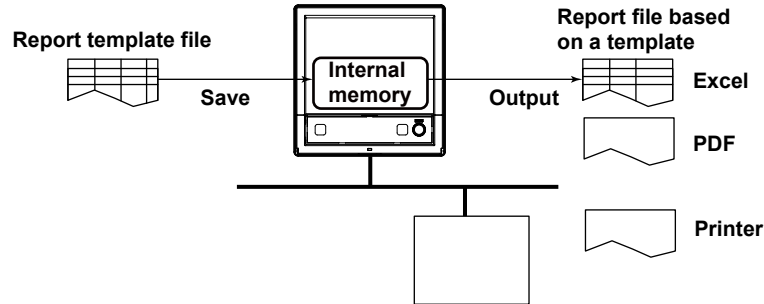

- ▶ Creating a report template: page App-17 in section Appendix 4, “Creating Report Templates”
- ▶ Loading and saving report templates: page 1-230 in section 1.25.3, “Loading Report Templates (/MT option)”page 1-243 in section 1.26.3, “Saving a Report Template”

### 1.17.1 Excel Report Files

- ▶ For instructions on how to create templates, see page App-17 in section Appendix 4, “Creating Report Templates”.

#### Template

Item	Description
Format, extension	Excel format. The extension is .xlsx or .xlsm (with macro) (lowercase).
File name	Assign a file name of your choosing.
Kind	Creates a report template for each kind of report file. The kinds of report files available are hourly, daily, weekly, monthly, hourly + daily, daily + weekly, daily + monthly, batch, and day custom.
Creation method	Create templates using Microsoft Office 2007 or more.

#### Excel Report Files

Item	Description
Format, extension	Excel format. You can open the file with Excel. The extension is .xlsx or .xlsm (with macro).
File name	The file name excluding the extension is the same as the report file with the .GRE extension. ▶ File name: page 1-141 in section 1.14.1, “Setting the Save Directory, File Header, and File Name”
Kind	For each kind of report file, a corresponding template file is used to create the appropriate report files.  The report file that you create is based on the report creation setting. For example, if the GX/GP is not configured to create daily reports, you will not be able to use a report template to create daily reports. However, regardless of this setting, you can output the data of all data types (average, maximum, minimum, sum, and instantaneous).

## 1.17.2 PDF Report Files

- ▶ For instructions on how to create templates, see page App-17 in section Appendix 4, “Creating Report Templates”.

### Template

Item	Description
Format, extension	Yokogawa proprietary format. The extension is .tpl (lowercase).
File name	Assign a file name of your choosing.
Kind	Creates a report template for each kind of report file. The kinds of report files available are hourly, daily, weekly, monthly, hourly + daily, daily + weekly, daily + monthly, batch, and day custom.
Creation method	Create templates using a YOKOGAWA's original tool.

### PDF Report Files

Item	Description
Format, extension	PDF format. The extension is .pdf (lowercase).
File name	The file name excluding the extension is the same as the report file with the .GRE extension. ▶ File name: page 1-141 in section 1.14.1, “Setting the Save Directory, File Header, and File Name”
Kind	For each kind of report file, a corresponding template file is used to create the appropriate report files.  The report file that you create is based on the report creation setting. For example, if the GX/GP is not configured to create daily reports, you will not be able to use a report template to create daily reports. However, regardless of this setting, you can output the data of all data types (average, maximum, minimum, sum, and instantaneous).

## 1.17.3 Printing on a Printer over the LAN

### Report template

The report template for PDF reports is used to output data to the printer.

### Printer output

Item	Description
Compatible printers	Printers supporting the HP PCL5c language and can print through port 9100 on a LAN connection ▶ For configuring the printer, see page 1-213 in section 1.23.7, “Setting the Printer Output Conditions”.
Kind	For each kind of report file, the specified template file is used to create the appropriate report files. The report file that you create is based on the report creation setting. For example, if the GX/GP is not configured to create daily reports, you will not be able to create daily reports. However, regardless of this setting, you can output the data of all data types (average, maximum, minimum, sum, and instantaneous).

### 1.17.4 Creating Template-Based Report Files

Template-based report files are created (the creation of template-based report files will hereinafter be referred to as “template conversion”) in the following cases.

- ▶ For instructions on how to set the type of files to output, see page 1-151 in section 1.16.1, “Setting the Report Type, Creation Time, Data Type, Etc.”.

#### PDF Report Files and Excel Report Files

- **Auto Save**

When a report file is created (when file division occurs), template conversion is performed, and the report file is saved to the SD memory card. Template conversion is also performed when recording stops.

- **Manual Save (Collectively storing unsaved data)**

When you save a report file manually, template conversion is performed on the report files in the internal memory that have not yet been converted. Converted files are saved to the external storage medium.

- **Collective Storing of Data through the Touch Screen**

When you execute **All save** or **Report save** from the display menu, template conversion is performed on all the report files in the internal memory. Converted files are saved to the external storage medium.

#### Printer Output

When a report file is created (when file division occurs), template conversion is performed, and the report is output to a printer.

Template conversion is also performed when recording stops.

### 1.17.5 Loading and Saving Report Template Files

- ▶ For details on loading report template files, see page 1-230 in section 1.25.3, “Loading Report Templates (/MT option)”.
- ▶ For details on saving templates, see page 1-243 in section 1.26.3, “Saving a Report Template”.

#### About Report Template Files

For each kind of report file, a corresponding template file is used to create the appropriate report files.

Creates a report template for each kind of report file.

If the file type is Separate, a template for each type is necessary.

#### Example in which the report file type is Hourly +Daily

File type	Template
Combine	An Hourly + Daily report template is necessary.
Separate	An Hourly and Daily report templates are necessary.

## 1.18 Setting the Timers

Set the timers that are used in the event action function and the TLOG computation of the math function (/MT option). There are two types of timers: absolute and relative. You can set up to 12 timers for each type. <sup>1</sup> You cannot change timers during recording or computing.

<sup>1</sup> For release number 3 and later, up to 12 timers can be set. For release numbers earlier than 3, up to 4 timers can be used.

### 1.18.1 Setting the Timers

#### Path

GX/GP: **MENU** key > **Browse** tab > **Setting** > Setting menu **Timer settings** > Timer **Timer 1 to 12**

Web application: **Config.** tab > **Timer settings** > **Timer**

Hardware configurator: **Timer settings** > **Timer**

#### Description

#### Type

Setup Item	Selectable Range or Options	Default Value
Type	Off/Relative/Absolute	Off

#### Type

Set the timer type.

Options	Description
Relative timer	Times out at specified intervals.
Absolute timer	Expires at the times determined by the reference time and the interval.

#### Interval<sup>1</sup>

Setup Item	Selectable Range or Options	Default Value
Day <sup>2</sup>	0 to 31	0
Hour <sup>2</sup>	0 to 23	1
Minute <sup>2</sup>	0 to 59	0
Interval <sup>3</sup>	1min, 2min, 3min, 4min, 5min, 6min, 10min, 12min, 15min, 20min, 30min, 1h, 2, h, 3h, 4h, 6h, 8h, 12h, 24h	1h

<sup>1</sup> Appears when the type is not set to **Off**.

<sup>2</sup> Appears when the type is set to **Relative timer**.

<sup>3</sup> Appears when the type is set to **Absolute timer**.

#### Day, Hour, Minute

Set the interval for the relative timer.

#### Interval

Set the interval for the absolute timer.

#### Action on Math Start<sup>1</sup>

Setup Item	Selectable Range or Options	Default Value
Reset	Off, On	On

<sup>1</sup> Appears when the type is set to **Relative timer**.

#### Reset

Set this to **On** to reset the timer when starting computation. Set this to **Off** to not reset. The timer does not expire (if the timer is specified as an event, the action will not be executed).

## 1.18 Setting the Timers

### Reference time<sup>1</sup>

Setup Item	Selectable Range or Options	Default Value
Hour	0 to 23	0
Minute	0 to 59	0

<sup>1</sup> Appears when the type is set to **Absolute timer**.

### Hour, Minute

Set the reference time for the absolute timer.

#### Explanation

##### Timers

- **Relative Timer**

The timer is started when the timer is set, and the timer expires every specified interval. In this mode, the timer stops when a power failure occurs.

Example: Interval: 00:15

The timer expires every 15 minutes.

- **Absolute Timer**

The timer expires at the times determined by the reference time and the interval. The reference time is set on the hour (00 to 23).

Example: Reference time: 00:00

Interval: 10 min

The timer expires at 0 hour, 0 hour 10 min, 0 hour 20 min, . . . 23 hour 40 min, and 23 hour 50 min.

For example, if the timer is set at 9 hour 36 min, the timer expires at 09 hour 40 min, 09 hour 50 min, 10 hour, and so on.

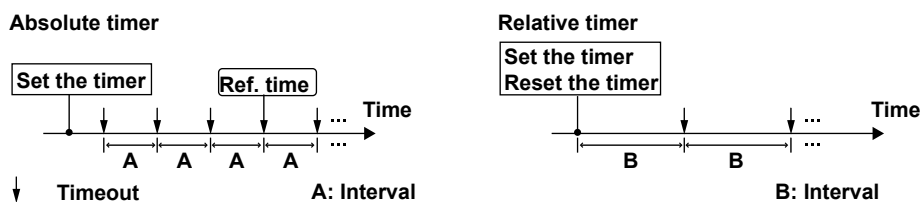

## 1.18.2 Setting the Match Time Timer

#### Path

GX/GP: **MENU** key > **Browse** tab > **Setting** > Setting menu **Timer settings** > Match time timer **Match time timer 1 to 12**

Web application: **Config.** tab > **Timer settings** > **Match time timer**

Hardware configurator: **Timer settings** > **Match time timer**

#### Description

### Type

Setup Item	Selectable Range or Options	Default Value
Type	Off, Day, Week, Month, Year	Off

### Type

Set the kind of match time timer.

Options	Description
Off	Disables the function.
Day	Set the time match condition of a day.
Week	Set the time match condition of a week.
Month	Set the time match condition of a month.
Year	Set the time match condition of a year.



## Timer match condition<sup>1</sup>

Setup Item	Selectable Range or Options	Default Value
Day of week	Sunday to Saturday	Sunday
Month	January to December	January
Day	1 to 31 <sup>2</sup>	1
Hour	0 to 23	0
Minute	0 to 59	0

- 1 Appears when the type of timer is not set to **Off**. The items that are displayed varies depending on the Type setting.
- 2 If Type is set to **Year**, the range varies depending on the timer match condition **Month**. If Type is set to **Month**, the range is 1 to 28.

## Day of Week, Month, Day, Hour, Minute

Set each timer match condition.

Depending on the Type setting, set the items with check marks in the table below.

Setup Item	Kind			
	Day	Week	Month	Year
Month				✓
Day			✓	✓
Day of week		✓		
Hour:Minute	✓	✓	✓	✓

## Timer action

Setup Item	Selectable Range or Options	Default Value
Timer action	Single, Repeat	Repeat

## Timer action

Set the timer action.

Options	Description
Single	Executes the action once when the condition is met.
Repeat	Executes the action at every specified time.

## 1.19 Configuring the Event Action Function

The event action function is used to execute a specified action on the basis of events that occur. The settings explained here are also used to configure the remote control function.

### 1.19.1 Setting Event Action Numbers and Actions

Select an event action number, and set event action to On.  
Set the even type and event-specific conditions.  
Then, set the action for the event and the action conditions.

#### Path

GX/GP: **MENU** key > **Browse** tab > **Setting** > Setting menu **Event action**  
Web application: **Config.** tab > **Event action** > **Event action number (display example: 1-20)**  
Hardware configurator: **Event action** > **Event action number (display example: 1-20)**

#### Description

Setup Item	Selectable Range or Options	Default Value
Event action number	1 to 50	1

#### Event action number

Select the event action number to assign an event action.

#### Event action

Setup Item	Selectable Range or Options	Default Value
On/Off	Off, On	Off

#### On/Off

Select **On** to use the event action function.

#### Event<sup>1</sup>

Setup Item	Selectable Range or Options	Default Value
Type	Internal switch, Remote, <sup>4</sup> Relay, Alarm - IO channel, Alarm - Math channel, Alarm - Communication channel, Any alarm, Any future alarm, Timer, Match time timer, User function key <sup>8</sup> , Status <sup>8</sup>	Internal switch
Number <sup>2</sup>	IO channel, Math channel, Communication channel, Internal switch, Timer, Match time timer, User function key, Relay, Remote	1
Alarm level <sup>3</sup>	1 to 4	1
Event details <sup>6</sup>	Recording, Math, User lock out <sup>7</sup> , Under login <sup>7</sup> , Memory/ Recording Media error, Measurement error, Communication error	
Operation mode	Rising edge, Falling edge, Rising/Falling edge, Edge <sup>5</sup>	Rising edge

- 1 Appears when Event action is set to **On**.
- 2 Does not appear when Type is set to **Any alarm**.
- 3 Appears when the Type is to Alarm - I/O channel, Alarm - Math channel, or Alarm - Communication channel.
- 4 Appears when the operation mode of the DI module is set to **Remote**.
- 5 Appears when the event is set to **Timer** or **Match time timer**.
- 6 Appears when the type is set to **Status**.
- 7 Appears for the advanced security function (/AS option).
- 8 Release number 2 and later.

## Type

Set the event conditions for executing the action.

Event Type	Description
Internal switch	Select the internal switch number.
Remote	Select the DI channel number of the remote control input. You cannot set this on a DI of a PID control module.
Relay	Select the DO channel number. You cannot set this on a DO of a PID control module with the type set to Contact output within module.
Alarm - I/O channel	Set the alarm of an I/O channel <sup>1</sup> . Channels of PID control modules are not included.
Alarm - Math channel	Set the alarm of a math channel <sup>1</sup> .
Alarm - Communication channel	Set the alarm of a communication channel <sup>1</sup> .
Any alarm	The change from no active alarms to one or more active alarms is regarded as an event. Alarms of PID control modules are also included.
Any future alarm	The change from no active future alarms to one or more active future alarms is regarded as an event.
Timer	Select a timer number. Timer timeout.
Match time timer	Select a match time timer number. When the time matches.
User function key	Select the user function key number.
Status	Select the status.

<sup>1</sup> Alarms whose **Logging** is set to **Off** in the alarm settings are also applicable.

## Number

Set a number from the following table depending on the event type.

Event Type	Description
Internal switch	Internal switch number
Relay	Output relay number (DO channel number)
Alarm - I/O channel	I/O channel number
Alarm - Math channel	Math channel number
Alarm - Communication channel	Communication channel number
Timer	Timer number
Match time timer	Match time timer number
User function key	User function key number

## Alarm level

Set the alarm level (1 to 4).

## Event details (release number 2 and later)

Set the status.

Detail	Description
Recording	Recording in progress.
Math	Math in progress.
User lock out	User lock out occurring.
Under login	There is a user logged in.
Memory/Media error <sup>1</sup>	Internal memory or external media error
Measurement error <sup>1</sup>	Measurement error status.
Communication error <sup>1</sup>	Communication error status.

<sup>1</sup> For details, see page 1-211 in section 1.23.6, "Setting the FAIL Relay and Instrument Information Output (/FL option)".

## Operation mode

Set the edge type for performing actions.

Operation mode	Description
Rising edge	The action is executed when the event changes from off to on.
Falling edge	The action is executed when the event changes from on to off.
Rising / Falling edge	When the event changes from off to on, the action is changed from off to on. When the event changes from on to off, the action is changed from on to off. You can set this on events other than <b>Timer</b> and <b>Match time timer</b> .
Edge	The action is executed when an event occurs. This applies when the event is set to <b>Timer</b> or <b>Match time timer</b> .

## 1.19 Configuring the Event Action Function

### Operation Modes That Can Be Specified Depending on the Event

The settings with check marks in the table below are possible.

Event	Rising edge	Falling edge	Rising / Falling edge	Edge
Remote (DI)	✓	✓	✓	
Internal switch	✓	✓	✓	
Relay (DO)	✓	✓	✓	
Alarm - I/O channel	✓	✓	✓	
Alarm - Math channel	✓	✓	✓	
Alarm - Communication channel	✓	✓	✓	
Any alarm	✓	✓	✓	
Any future alarm	✓	✓	✓	
Timer				✓
Match time timer				✓
User function key				✓
Status	✓	✓	✓	

#### Falling edge

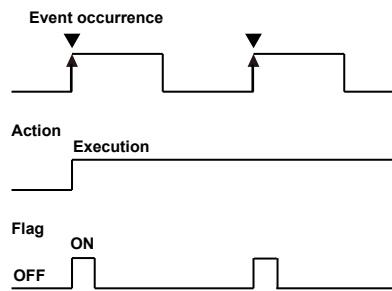

#### Rising edge

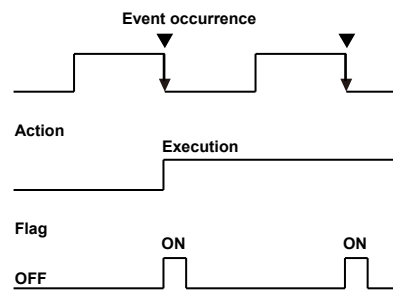

#### Rising / Falling edge

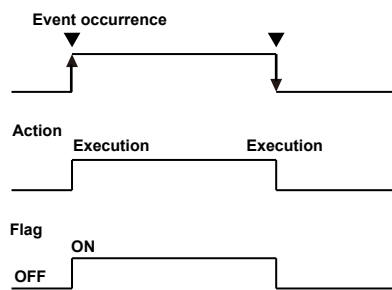

#### Edge (timer, match time timer)

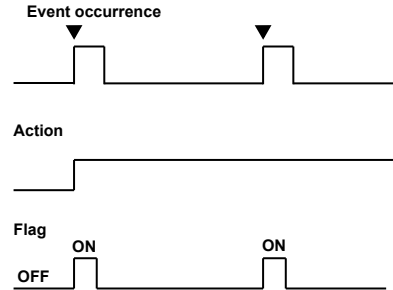

## Action

Setup Item	Selectable Range or Options	Default Value
Type	<p><b>When the operation mode is rising edge, falling edge, or edge</b> Recorded, Computation, Switch the display rate, Flag, Manual sample, AlarmAck, Snapshot, Adjust the time, Save display data, Save event data, Event trigger<sup>7</sup>, Message, Switch the display group, Reset the relative timer, Load setting, Show the favorite display, Relay, Internal switch, Load program pattern<sup>10</sup></p> <p><b>When the operation mode is Rising/Falling edge</b> Recording start/stop, Computation start/stop, Switch the display rate 1/2, Flag On/Off, Relay On/Off, Internal switch On/Off</p>	—
Number <sup>1</sup>	Depends on the type	
Detail <sup>2</sup>	Start, <sup>4</sup> Stop, <sup>4</sup> Reset, <sup>5</sup> All groups, <sup>6</sup> Specified group, <sup>6</sup> On/Off <sup>8</sup>	—
Group number <sup>3</sup>	GX20-1/GP20-1: 1 to 50 GX20-2/GP20-2: 1 to 60 GX10/GP10: 1 to 30	1
Batch group number <sup>9</sup>	ALL GX10/GP10/GX20-1/GP20-1: 1 to 6 GX20-2/GP20-2: 1 to 12	1

- 1 Appears when the type is set to Switch the display rate, Flag, Message, Switch the display group, Reset the relative timer, Show the favorite display, Flag On/Off, Relay, Relay On/Off, Internal switch, or Internal switch On/Off, Load program pattern.
- 2 Appears when the type is set to **Recorded**, **Computation**, **Message**, **Relay**, or **Internal switch**.
- 3 Appears when the type is set to **Message** and Detail is set to **Specified group**.
- 4 Appears when the type is set to **Recorded**, or **Computation**.
- 5 Appears when the type is set to **Computation**.
- 6 Appears when the type is set to **Message**.
- 7 Does not appear for the advanced security function (/AS option).
- 8 Appears when the type is set to **Relay** or **Internal switch**.
- 9 When the multi-batch function (/BT option) is enabled, this appears when the type is set to Recorded, Computation, Save display data, Save event data, Message, or Switch the display group. However, for Computation, the detail must be set to Reset.
- 10 You can set this when the event is set to Remote or User function key.

## Type

Set the action to execute when an event occurs.

### When the Event Operation Mode Is Rising Edge or Falling Edge

Options	Description
Recorded	Starts or stops recording.
Computation	Starts or stops computation (/MT option) or resets the computed values of all math channels.
Switch the display rate	Switches the trend interval and the secondary trend interval. You can specify this setting when Trend rate switching is set to <b>On</b> .
Flag	Sets the flag to 1 (On). (/MT option).
Manual sample	Executes manual sampling.
Alarm ACK	Clears the alarm output. Control alarm output of PID control modules are also included.
Snapshot	Saves the screen image data.
Save display data	Saves the display data being recorded to a file in the internal memory. You can specify this when the GX/GP is configured to record display data.
Save event data	Saves the event data being recorded to a file in the internal memory. You can specify this when the GX/GP is configured to event display data.
Event trigger	Applies a trigger that starts event data recording. You can specify this when the GX/GP is configured to event display data.
Message	Writes a message. Specify the message number and the message write destination. Set the destination to all groups, or specify a write destination group number. You can execute this while recording is in progress.
Switch the display group	Switches the display group in trend, digital, or bar graph display. Specify the number of the group to display.
Reset the relative timer	Resets a relative timer. The timer starts immediately.

Continued on the next page

## 1.19 Configuring the Event Action Function

Options	Description
Show the favorite display	Switches to the specified favorite screen
Load settings	Loads the setting parameter file in the root directory of the SD memory card and configures the GX/GP accordingly. (See the explanation.)
Adjust the time	Sets the clock to the nearest hour.
Relay	Set the relay output to On or Off. DO channels of PID control modules are applicable. However, this is available only when the type is set to Manual.
Internal switch	Set the internal switch to On or Off. However, this is available only when the type is set to Manual.
Load program pattern	Loads all the pattern files (ProgPatYY, YY: 01 to 99) in the specified folder at the root directory of the SD memory card.

Folder name	Content
LoadProgPatXX	XX: 01 to 10

File name	Content
ProgPatYY	YY: 01 to 99

### When the Event Operation Mode Is Rising/Falling Edge

Options	Description
Recording start/stop	Repeats recording start and stop on every event occurrence.
Computation start/stop	Repeats computation (/MT option) start and stop on every event occurrence.
Switch the display rate 1, 2	Switches the display rate on every event occurrence.
Flag On/Off	Repeats the operation of setting the flag to 1 (On) and 0 (Off) on every event occurrence.
Relay On/Off	Repeats the operation of setting the relay to On and Off on every event occurrence.
Internal switch On/Off	Repeats the operation of setting the internal switch to On and Off on every event occurrence.

### Detail

Set the details of action when the action type is set to **Recorded**, **Computation**, **Message**, **Relay**, or **Internal switch**.

### When Set to Recorded or Computation

Options	Description
Start	Starts recording or computation.
Stop	Stops recording or computation.
Reset (Computation only)	Resets computation.

### When Set to Message

Options	Description
All groups	Writes the message to all groups.
Specified group	Writes the message to the specified group. Set the destination by specifying a group number.

**When Set to Relay or Internal switch**

Options	Description
On	Sets to On (relay or internal switch).
Off	Sets to Off (relay or internal switch).

**Note**

Do not manually operate a relay assigned to a status event or the output status of an internal switch action.

**Number**

Set the target number for Message, Show the specified display, Reset the relative timer, Switch the display group, Event trigger, Flag, Switch the display rate, user function key, or Load program pattern.

Operation mode	Type	Setup Item
	Switch the display rate	Display rate number (First, Second)
	Flag	Flag number 1 to 20
	Event trigger	Measurement group 1, Measurement group 2 <sup>1</sup>
	Message	Message number 1 to 100
	Switch the display group	Display Group GX20/GP20: 1 to 50 GX20-2/GP20-2: 1 to 60 GX10/GP10: 1 to 30
Rising edge, Falling edge, Edge		When the multi-batch function (/BT option) is enabled GX10/GP10/GX20-1/GP20-1: 1 to 6 GX20-2/GP20-2: 1 to 12
	Reset the relative timer	Timer number 1 to 12 (relative time)
	Show the favorite display	Screen number 1 to 20
	Load settings	Load number 1 to 10
	Load program pattern <sup>1</sup>	File number 1 to 10
Rising / Falling edge	Flag On/Off	Flag number 1 to 20
	Relay On/Off	DO channel number

<sup>1</sup> When the measurement mode is Dual interval. Release number 4 and later.

**Group number**

Set the display group number to write the message to when **Specified group** is specified.

**Batch group number**

When the multi-batch function (/BT option) is enabled, set the batch group on which to execute the action.

Options	Description
All	Specifies all batch groups. However, this is available only when the type is set to Recorded, Computation, Save display data, or Save event data. However, for Computation, the detail must be set to Reset.
GX10/GP10/GX20-1/GP20-1: 1 to 6 GX20-2/GP20-2: 1 to 12	Specifies a batch group.

### Explanation

#### Resetting a Relative Timer

Resets a timer and starts it.

If you reset a relative timer, it is considered to have expired (if the timer is being used as an event, the corresponding action is executed).

#### Resetting a Match Time Timer

Resets a match time timer after it expires so that it is enabled again.

- Resetting a match time timer is not considered a timeout (even if it is being used as an event in the event action function, the corresponding action is not executed).
- This operation can be used with match time timers whose timer action is set to single.

#### Loading Setting Parameters

This action can be specified only when the event is set to remote control input.

This action loads a setup data file from the root directory of the SD memory card and configures the GX/GP accordingly. Setup data files are named "LOAD1.GNL," "LOAD2.GNL," and so on up to "LOAD10.GNL." If the advanced security function is enabled, the extension is .GSL.

You must create a setting parameter file and save it to the SD memory card in advance. If the advanced security function (/AS option) is in use, security settings are not loaded.

#### Time Adjustment

Time adjustment can be specified as an action only when the event is set to remote control input. This action sets the GX/GP internal clock to the nearest hour.

- **Operation When Recording Is Stopped**

Difference from the Nearest Hour	Operation
00 min 00 s to 01 min to 59 s	Truncates the minutes and seconds. Example: 10 hours 01 min 50 s becomes 10 hours 00 min 00 s.
02 min 00 s to 57 min to 59 s	The time is not changed.
58 min 00 s to 59 min to 59 s	Rounds up the minutes and seconds. Example: 10 hours 59 min 50 s becomes 11 hours 00 min 00 s.

- **Operation during Recording**

If the time difference between the event occurrence time and the nearest hour is within the time specified by **Gradually adjusting the time** of **Time basic settings**, the time is gradually corrected. Otherwise, the time is corrected according to **Time adjustment beyond limit**.

- ▶ See the explanation in page 1-207 in section 1.23.4, "Setting the Time Zone, Gradual Time Adjustment, and Daylight Saving Time".

#### Internal Switches and Relay Output for Scan Intervals Shorter Than 100 ms

Internal switches and relays triggered by event actions are output at 100 ms intervals.



### Limitations on the Combinations of Events and Actions

The combinations that are checked in the table below can be used.

Event \ Action	Action												
	Remote DI <sup>4</sup>	Relay (DO)	Internal switch	Alarm - IO channel	Alarm - Math channel	Alarm - Communication channel	Any alarm	Any future alarm	Timer	Match timer	User function key <sup>2</sup>	Status	
Recording	✓	✓	✓	✓	✓	✓	✓	✓	✓	✓	✓	✓	
Recording start/stop <sup>1</sup>	✓	✓	✓	✓	✓	✓	✓	✓	✓	✓	✓	✓	
Computation	✓	✓	✓	✓	✓	✓	✓	✓	✓	✓	✓	✓	
Computation start/stop <sup>1</sup>	✓	✓	✓	✓	✓	✓	✓	✓	✓	✓	✓	✓	
Manual sample	✓	✓	✓	✓	✓	✓	✓	✓	✓	✓	✓	✓	
Alarm ACK	✓	✓	✓	✓	✓	✓	✓	✓	✓	✓	✓	✓	
Snapshot	✓	✓	✓	✓	✓	✓	✓	✓	✓	✓	✓	✓	
Save display data	✓	✓	✓	✓	✓	✓	✓	✓	✓	✓	✓	✓	
Save event data	✓	✓	✓	✓	✓	✓	✓	✓	✓	✓	✓	✓	
Event trigger	✓	✓	✓	✓	✓	✓	✓	✓	✓	✓	✓	✓	
Message	✓	✓	✓	✓	✓	✓	✓	✓	✓	✓	✓	✓	
Switch the display group	✓	✓	✓	✓	✓	✓	✓	✓	✓	✓	✓	✓	
Reset the relative timer	✓	✓	✓	✓	✓	✓	✓	✓	✓	✓	✓	✓	
Load settings	✓	✓	✓	✓	✓	✓	✓	✓	✓	✓	✓	✓	
Load program file	✓	✓	✓	✓	✓	✓	✓	✓	✓	✓	✓	✓	
Adjust the time	✓	✓	✓	✓	✓	✓	✓	✓	✓	✓	✓	✓	
Show the favorite display	✓	✓	✓	✓	✓	✓	✓	✓	✓	✓	✓	✓	
Switch the display rate	✓	✓	✓	✓	✓	✓	✓	✓	✓	✓	✓	✓	
Switch the display rate 1/2 <sup>1</sup>	✓	✓	✓	✓	✓	✓	✓	✓	✓	✓	✓	✓	
Flag	✓	✓	✓	✓	✓	✓	✓	✓	✓	✓	✓	✓	
Flag On/Off <sup>1</sup>	✓	✓	✓	✓	✓	✓	✓	✓	✓	✓	✓	✓	
Relay <sup>3</sup>	✓	✓	✓	✓	✓	✓	✓	✓	✓	✓	✓	✓	
Relay On/Off <sup>1, 3</sup>	✓	✓	✓	✓	✓	✓	✓	✓	✓	✓	✓	✓	
Internal Switch <sup>3</sup>	✓	✓	✓	✓	✓	✓	✓	✓	✓	✓	✓	✓	
Internal switch On/Off <sup>1, 3</sup>	✓	✓	✓	✓	✓	✓	✓	✓	✓	✓	✓	✓	

- 1 When the operation mode is Rising/Falling edge.
- 2 Operation lock is applied to the user function keys according to the action specified by event action.
- 3 Action can be set to Relay output, Relay On/Off, Internal switch, or Internal switch On/Off only when the DO channel range type and internal switch type is set to Manual.
- 4 Only for DI modules installed in the GX/GP main unit whose operation mode is set to Remote.

### 1.19.2 Event Action Examples

#### Example 1: Starting/Stopping Recording through Remote Control

Starts or stops recording when a remote control signal is applied to DI channel 0101. This example assumes that a DI module is installed in slot 1 of the GX/GP. We assume that a DI module is installed in slot 1 of the GX/GP main unit and that the operation mode is set to Remote. Use event action number 1.

#### Setting the Mode of the DI Module

- **Setup Screen**  
**MENU** key > **Browse** tab > **Setting** > Setting menu **Measurement settings** > Module settings **Select module** > **Module 1 GX90XD-16-11N**
- **Setup Items**

Setup Item	Value	
Operation mode	Operation mode	Remote

#### Configuring the Event Action

- **Setup Screen**  
**MENU** key > **Browse** tab > **Setting** > Setting menu **Display settings** > **Event action**
- **Setup Items**

Setup Item	Value	
Event action number	1	
Event action	On/Off	On
Event	Type	Remote
	Number	0101
	Operation mode	Rising / Falling edge
Action	Type	Recording start/stop

#### Operation

If the DI channel 0101 input is turned on when recording is stopped, recording starts. If the DI channel 0101 input is turned off when recording is in progress, recording stops.

#### Example 2: Writing a Message When an Alarm Occurs

Write the message “Channel 1 Alarm” to group 1 when an alarm occurs on channel 0001. This example assumes that an AI module is installed in slot 0 of the GX/GP. Use event action number 2.

#### Configuring the Event Action

- **Setup Screen**  
**MENU** key > **Browse** tab > **Setting** > Setting menu **Display settings** > **Event action**
- **Setup Items**

Setup Item	Value	
Event action number	2	
Event action	On/Off	On
Event	Type	Alarm - IO channel
	Number	0001
	Alarm level	1
	Operation mode	Rising edge
Action	Type	Message
	Number	1
	Detail	Specified
	Group number	1

#### Other Settings

- Set AI channel 0001 to alarm level 1.
  - ▶ Setup: See page 1-35 in section 1.2.2, “Setting Alarms”.
- Register “Channel 1 Alarm” in message number 1.
  - ▶ Setup: See page 1-113 in section 1.10.3, “Setting Messages”.

**Example 3: Saving the Data Every Day at Hour 17**

Save recorded data to the SD memory card every day at hour 17. Use event action number 3. Use match time timer number 1.

**Setting Match Time Timer 1**• **Setup Screen**

GX/GP: **MENU** key > **Browse** tab > **Setting** > Setting menu **Timer settings** > Match time timer 1

• **Setup Items**

Setup Item		Value
Kind	Kind	Day
Timer match condition	Hour	17
	Minute	00
Timer action	Timer action	Repeat

**Configuring the Event Action**• **Setup Screen**

**MENU** key > **Browse** tab > **Setting** > Setting menu **Display settings** > **Event action**

• **Setup Items**

Setup Item		Value
Event action number		3
Event action	On/Off	On
	Type	Match time timer
Event	No.	1
	Operation mode	Edge
	Type	Save display data

**Other Settings**

Set the display data to be saved automatically. Set the file save interval to **1day** or longer. If a file save interval shorter than **1day** is specified, the data is also saved at the file save interval.

- ▶ Setup: See page 1-125 in section 1.12.1, “Setting the Type of Data to Record (Display or event data) and Recording Conditions”.
- ▶ Setup: See page 1-143 in section 1.14.2, “Setting the Save Method to Media (Auto save or manual save) and Media FIFO”.

**Example 4: Setting DO to OFF and When Recording Starts and DO to ON When Recording Stops**

Set the output status of DO channel 0009 to ON when recording stops and OFF when recording starts.

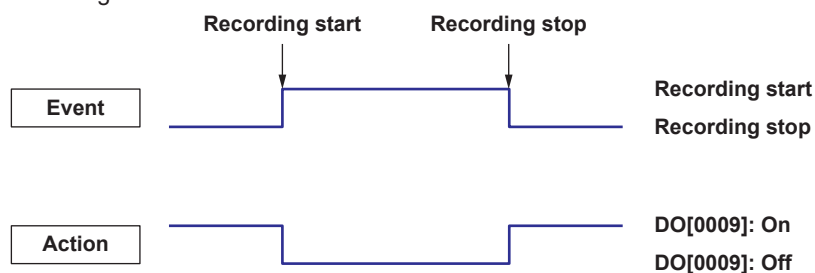

This example assumes that a DI/DO module is installed in slot 0 of the GX/GP main unit. Use event action numbers 4 and 5.

## 1.19 Configuring the Event Action Function

---

### Setting the DO Channel Type

- **Setup Screen**

**MENU** key > **Browse** tab > **Setting** > Setting menu **DO channel settings** > **Range**

- **Setup Items**

Setup Item	Value
First-CH/Last-CH	009
Range	Type Manual

### Configuring the Event Action

- **Procedure**

**MENU** key > **Browse** tab > **Setting** > Setting menu **Event action**

- **Setup Items**

Setup Item	Value
Event action number	4
Event action	On/Off On
Event	Type Status
	Detail Record
	Operation mode Rising edge
Action	Type Relay
	No. 0009
	Detail Off

Setup Item	Value
Event action number	5
Event action	On/Off On
Event	Type Status
	Detail Record
	Operation mode Falling edge
Action	Type Relay
	No. 0009
	Detail On

## 1.20 Configuring Communication Channels (/MC option)

Set communication channels.

Set these items to make the GX/GP record data from Modbus devices or PCs.

When the measurement mode is set to High speed or Dual interval, there is a limit to the number of communication channels at scan intervals shorter than 100 ms. For details, see the following general specifications.

GX/10/GX20 Paperless Recorder (panel mount type)

GS 04L51B01-01EN

GP10/GP20 Paperless Recorder (portable type)

GS 04L52B01-01EN

### 1.20.1 Enabling Communication Channels and Setting the Span, Decimal Point, and Unit

#### Path

GX/GP: **MENU** key > **Browse** tab > **Setting** > Setting menu **Communication channel settings** > **On/Off, Span**

Web application: **Config.** tab > **Communication channel settings** > **Channel range** (display example: C001-C020) > **On/Off, Span**

Hardware configurator: **Communication channel settings** > **Channel range** (display example: C001-C020) > **On/Off, Span**

#### Description

Setup Item	Selectable Range or Options	Default Value
First-CH	GX20-1/GP20-1: C001 to C300 GX20-2/GP20-2: C001 to C500 GX10/GP10: C001 to C050	C001
Last-CH	Same as the first channel	C001

#### First-CH, Last-CH

Set the target channels.

#### On/Off, Span

Setup Item	Selectable Range or Options	Default Value
On/Off	Off, On	Off
Decimal place <sup>1</sup>	0, 1, 2, 3, 4, 5	0
Span Lower <sup>1</sup>	-9999999 to 99999999	0
Span Upper <sup>1</sup>	-9999999 to 99999999	100
Unit <sup>1</sup>	Character string (up to 6 characters, <b>Aa#1</b> )	—

<sup>1</sup> Appears when a communication channel is set to **On**.

#### On/Off

Select **On** to use the communication channels.

#### Decimal place

Set the decimal place for span lower and span upper.

#### Span Lower, Span Upper

Set the input range.

#### Unit

Set the unit.

#### At Power on<sup>1</sup>

Setup Item	Selectable Range or Options	Default Value
Value at power on	Last value, Preset value	Last value

<sup>1</sup> Appears when On/Off is set to **On**.

#### Value at power on

Set the value to replace the communication channel value at power-on.

## 1.20 Configuring Communication Channels (/MC option)

### Preset value<sup>1</sup>

Setup Item	Selectable Range or Options	Default Value
Preset value	-9.999999E+29 to 9.999999E+29 -9.999999E+29 to -1.000000E-30, 0, 1.000000E-30 to 9.999999E+29	0

<sup>1</sup> Appears when On/Off is set to **On**.

### Preset value

Set the preset value.

### Watchdog timer

Setup Item	Selectable Range or Options	Default Value
On/Off	Off, On	Off
Timer <sup>1</sup>	1 to 120 (s)	30
Value at timer-expired <sup>1</sup>	Last value, Preset value	Last value

<sup>1</sup> Appears when the watchdog timer is set to **On**.

### On/Off

Set this to **On** to use the watchdog timer.

### Timer

Set the duration for monitoring values that fail to be updated.

If a value is not updated within the specified duration, the value is replaced.

### Value at timer-expired

Set whether to set the value when the timer expires to the last value or preset value.

## Explanation

### Watchdog Timer Function

Data may fail to be updated due to Modbus or other communication problems.

The watchdog timer function replaces values with preset values or last values when values are not updated within the specified duration (timer).

Data replacement occurs immediately when the timer expires, and the values are held until the next read cycle.

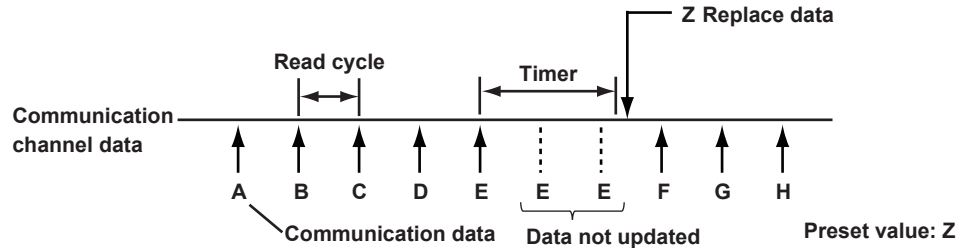

## 1.20.2 Setting Alarms

### Path

GX/GP: **MENU** key > **Browse** tab > **Setting** > Setting menu **Communication channel settings** > **Alarm**

Web application: **Config.** tab > **Communication channel settings** > **Channel range**  
(display example: C001-C020) > **Alarm**

Hardware configurator: **Setting** tab > **Communication channel settings** > **Channel range**  
(display example: C001-C020) > **Alarm**

### Description

Setup Item	Selectable Range or Options	Default Value
First-CH	GX20-1/GP20-1: C001 to C300 GX20-2/GP20-2: C001 to C500 GX10/GP10: C001 to C050	C001
Last-CH	Same as the first channel	C001

### First-CH, Last-CH

Set the target channels.

### Level 1, Level 2, Level 3, Level 4

Setup Item	Selectable Range or Options	Default Value
On/Off	Off, On	Off
Type <sup>1</sup>	H: High limit, L: Low limit, T: Delay high limit, t: Delay low limit	H: High limit
Value <sup>1</sup>	–9999999 to 99999999	0.00
Hysteresis <sup>1,3</sup>	Numeric value (0 to 100000)	0.00
Logging <sup>1</sup>	On/Off	On
Output type <sup>1</sup>	Off, Relay, Internal switch	Off
Output No. <sup>2</sup>	DO channel or internal switch	—

1 Appears when a level (1 to 4) is set to **On**.

2 Appears when Output type is not set to **Off**.

3 Appears when the type is set to **H: High limit** or **L: Low limit**.

### On/Off

Set this to **On** to set alarms.

### Type

Set the alarm type.

### Value

Set the alarm value for the specified alarm type.

Options	Value
H, L	Within –9999999 to 99999999 excluding the decimal point.
T, t	Same as H and L

### Hysteresis

Set this to establish an offset between the value used to activate and release alarms.

### Logging

Set this **On** to display an alarm (notify you) when an alarm occurs. If set to **Off**, when an alarm occurs, the GX/GP outputs signals to alarm output DO channels or internal switches but does not display the alarm. Alarms are also not recorded in the alarm summary.

### Output type

Set the alarm output destination.

### Output No.

Set the number of the DO channel or internal switch to output alarms to.

## 1.20 Configuring Communication Channels (MC option)

### Alarm delay<sup>1</sup>

Setup Item	Selectable Range or Options	Default Value
Hour	1 to 24	0
Minute	0 to 59	0
Second	0 to 59	10

<sup>1</sup> Appears when Level 1, Level 2, Level 3, or Level 4 is **On**.

### Hour, Minute, and Second

Set the alarm delay. These values are valid when the delay high limit or delay low limit is in use.

► For details on alarm types, see page 1-35 in section 1.2.2, "Setting Alarms".

## 1.20.3 Setting the Display

### Path

GX/GP: **MENU** key > **Browse** tab > **Setting** > Setting menu **Communication channel settings** > **Display settings**

Web application: **Config.** tab > **Communication channel settings** > **Channel range** (display example: C001-C020) > **Display settings**

Hardware configurator: **Communication channel settings** > **Channel range** (display example: C001-C020) > **Display settings**

### Description

Setup Item	Selectable Range or Options	Default Value
First-CH	GX20-1/GP20-1: C001 to C300 GX20-2/GP20-2: C001 to C500 GX10/GP10: C001 to C050	C001
Last-CH	Same as the first channel	C001

### First-CH, Last-CH

Select the target channels.

### Tag

Setup Item	Selectable Range or Options	Default Value
Characters	Character string (up to 32 characters, <b>Aa#1</b> )	—
No.	Character string (up to 16 characters, <b>Aa#1</b> )	—

### Characters

Set the tag.

Not all characters may be displayed due to space constraints.

### No.

Set the tag number.



## Color

Setup Item	Selectable Range or Options	Default Value
Color	24 colors (red, green, blue, blue violet, brown, orange, yellow-green, light blue, violet, gray, lime, cyan, dark blue, yellow, light gray, purple, black, pink, light brown, light green, dark gray, olive, dark cyan, and spring green) and a user-defined color (1 color)	—

### Color

Set channel display colors. The colors apply to the trend display and bar graph display.

- ▶ For instructions on how to set the user-defined color, see page 1-40 in section 1.2.3, “Setting the Display”.

## Zone

Setup Item	Selectable Range or Options	Default Value
Lower	0 to 95%	0
Upper	5 to 100% input	100

### Lower and Upper

Set these values when you want to divide the waveform displays of channels into separate zones so that waveforms do not overlap. Set the **Lower** and **Upper** positions as percentages of the maximum display width. Set **Lower** to a value less than **Upper**, and set the zone width (**Upper – Lower**) to be 5% or greater.

- ▶ For zone display examples, see page 1-40 in section 1.2.3, “Setting the Display”.

## Scale

Setup Item	Selectable Range or Options	Default Value
Position	GX20/GP20: Off, 1, 2, 3, 4, 5, 6, 7, 8, 9, 10 GX10/GP10: Off, 1, 2, 3, 4, 5, 6	1
Division	4, 5, 6, 7, 8, 9, 10, 11, 12, C10	10

### Position

Set the scale display position of the trend display. Set this to **Off** to not display scales.

### Division

Set the number of divisions to make with the main scale marks.

C10: The scale is equally divided into 10 sections by main scale marks, and scale values are indicated at 0, 30, 50, 70, and 100% positions.

- ▶ For scale display examples, see page 1-40 in section 1.2.3, “Setting the Display”.

## Bar graph

Setup Item	Selectable Range or Options	Default Value
Base position	Lower, Center, Upper	Lower
Division	4, 5, 6, 7, 8, 9, 10, 11, 12	10

### Base position

Set the bar graph base position.

This setting is applied on the bar graph display and when you are displaying the current value on the scale as a bar graph on the trend displays.

- ▶ For bar graph display examples, see page 1-40 in section 1.2.3, “Setting the Display”.

### Division

Set the number of divisions to make with the main scale marks.

## 1.20 Configuring Communication Channels (/MC option)

### Partial<sup>1</sup>

Setup Item	Selectable Range or Options	Default Value
On/Off	Off, On	Off
Expand	1 to 99(%)	50%
Boundary	Span lower limit + 1 digit to span upper limit – 1 digit	0.01

<sup>1</sup> Appears when in the **Display settings** of the setting menu, the trend partial expansion **On/Off** is set to **On**.

### On/Off

Set this to **On** to enable partial expanded display of waveforms.

► For details on this function, see page 1-114 in section 1.10.4, “Setting Trend Display Conditions”.

### Expand

Set at which position to display the value specified by **Boundary** within the display width. Specify a percentage.

### Boundary

Set the value that is to be the boundary between the reduced section and the expanded section in the range of “minimum span value + 1 digit to maximum span value – 1 digit.” For channels that are set to scaling, the selectable range is “minimum scale value + 1 digit to maximum scale value – 1 digit.”

Example: Span: 0 to 100. Expand: 30. Boundary: 50The 0 to 50 range is displayed in the 0% to 30% range, and the 50 to 100 range is displayed in the 30% to 100% range.

### Color scale band

Setup Item	Selectable Range or Options	Default Value
Band area	Off, In, Out	Off
Color	24 colors (red, green, blue, blue violet, brown, orange, yellow-green, light blue, violet, gray, lime, cyan, dark blue, yellow, light gray, purple, black, pink, light brown, light green, dark gray, olive, dark cyan, and spring green) and a user-defined color (1 color)	—
Display position Lower	Span (scale) lower limit to span (scale) upper limit	0.00
Display position Upper	Span (scale) lower limit to span (scale) upper limit	1.00

### Band area

Displays a specified section of the measurement range using a color band on the scale. This setting is shared with the bar graph display.

Options	Description
Off	Disables the function.
In	Displays the area inside using the color band.
Out	Displays the area outside using the color band.

### Color

Set the display color.

### Display position Lower, Display position Upper

Set the display position. Set a value within the span range.

## Alarm point mark



Setup Item	Selectable Range or Options	Default Value
Indicate on Scale	Off, On	On
Mark kind	Alarm, Fixed	Alarm
Alarm 1 color to Alarm 4 color <sup>1</sup>	24 colors (red, green, blue, blue violet, brown, orange, yellow-green, light blue, violet, gray, lime, cyan, dark blue, yellow, light gray, purple, black, pink, light brown, light green, dark gray, olive, dark cyan, and spring green) and a user-defined color (1 color)	

<sup>1</sup> Appears when the Mark kind is set to Fixed.

### Indicate on Scale

Set this to **On** to display alarm point marks on the scale. Set this to **Off** to not display them. This setting is shared with the bar graph display.

### Mark kind

Options	Description	Mark Shape
Alarm	Displayed normally in green. Displayed in the specified color when an alarm occurs.	 or 
Fixed	Displayed with a fixed color.	

### Alarm 1 color to Alarm 4 color

When Mark kind is set to **Fixed**, set the display colors of point marks for alarm levels 1 to 4.

## 1.20.4 Setting Calibration Correction (Linearizer approximation, linearizer bias, Correction Factor <sup>1</sup> (release number 4 (version 4.02) and later))

<sup>1</sup> Only for the /AH option

### Path

GX/GP: **MENU** key > **Browse** tab > **Setting** > Setting menu **Communication channel settings** > **Calibration correction**

Web application: **Config.** tab > **Communication channel settings** > **Channel range** (display example: C001-C020) > **Calibration correction**

Hardware configurator: **Communication channel settings** > **Channel range** (display example: C001-C020) > **Calibration correction**

### Description

Setup Item	Selectable Range or Options	Default Value
First-CH	Communication channel	—
Last-CH	Communication channel	—

### First-CH, Last-CH

Set the target channels. You can set consecutive channels whose range is set to the same value as the first channel.

### On/Off

Setup Item	Selectable Range or Options	Default Value
On/Off	Off/On	Off <sup>1</sup>

<sup>1</sup> Communication channels whose On/Off setting is Off and channels whose span setting On/Off setting is Off are fixed to Off. (▶ refer to page 1-173 in section 1.20.1, "Enabling Communication Channels and Setting the Span, Decimal Point, and Unit")

### On/Off

Set the communication channels that you want to use to **On**.

### Limitation on the number of settings by model

Model	GX10/GP10	GX20-1/GP20-1	GX20-2/GP20-2
Number of channels that can be set to On	50	150	300

## 1.20 Configuring Communication Channels (/MC option)

### Mode

Setup Item	Selectable Range or Options	Default Value
Mode	Linearizer Approximation, Linearizer Bias, Correction Factor	Linearizer Approximation
Number of set points <sup>1</sup>	2 to 12	2

### Mode

Set the correction mode when performing calibration correction.

### Number of set points

Set the number of points that make up the segments (including the start and end points).

### 1 to 12 (When the mode is set to linearizer approximation or linearizer bias)<sup>1</sup>

Setup Item	Selectable Range or Options	Default Value
Linearizer input	-9999999 to 99999999	—
Linearizer output	-9999999 to 99999999	—

<sup>1</sup> The number of displayed points varies depending on the number of set points.

### Linearizer input, Linearizer output

Enter the value of the set point. For linearizer input, set a value that is greater than the previous value.

### 1 to 12 (When the mode is set to correction factor) (only for the /AH option)<sup>1</sup>

Setup Item	Selectable Range or Options	Default Value
Uncorrected value	-9999999 to 99999999	—
Instrument correction factor	-9999999 to 99999999	—
Sensor correction factor	-9999999 to 99999999	—

<sup>1</sup> The number of displayed points varies depending on the number of set points.

### Uncorrected value

Enter the uncorrected value. Set a value that is greater than the previous value.

### Instrument correction factor

Set the instrument-dependent correction factor.

### Sensor correction factor

Set the sensor-dependent correction factor.

**Explanation**

**Linearizer Approximation**

Corrects input values using characteristics specified with segments to derive output values.

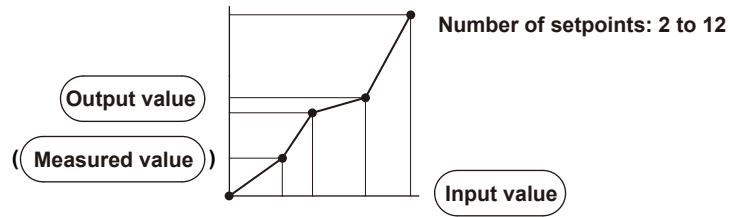

**Linearizer Bias**

Corrects input values using bias values specified with segments to derive output values.

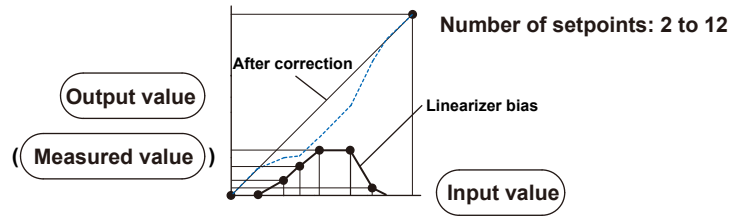

**Correction Factor**

Corrects input values using the instrument correction factor and sensor correction factor specified with segments to derive output values.

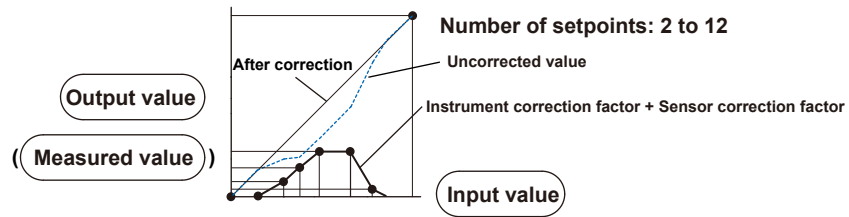

## 1.21 Configuring the Ethernet Communication Function

Set the Ethernet communication conditions.

For the WT connection client settings (WT communication (/E2 option)), see the WT Communication (/E2) User's Manual (IM 04L51B-19EN).

For the SLMP client settings (SLMP communication (/E4 option)), see the SLMP Communication (/E4) User's Manual (IM 04L51B-21EN).

### 1.21.1 Setting Basic Communication Conditions

#### Path

GX/GP: **MENU** key > **Browse** tab > **Setting** > Setting menu **Communication (Ethernet) settings > Basic settings**

Web application: **Config.** tab > **Communication (Ethernet) settings > Communication (Ethernet) Basic settings**

Hardware configurator: **Communication (Ethernet) settings > Ethernet basic settings**

#### Description

#### Automatic IP settings

Setup Item	Selectable Range or Options	Default Value
Obtain IP address automatically	Off, On	Off

#### Obtain IP address automatically

Set this to **On** to automatically obtain the IP address (DHCP).

#### IP Address<sup>1</sup>

Setup Item	Selectable Range or Options	Default Value
IP address	0.0.0.0 to 255.255.255.255	0.0.0.0
Subnet mask	0.0.0.0 to 255.255.255.255	0.0.0.0
Default gateway	0.0.0.0 to 255.255.255.255	0.0.0.0

<sup>1</sup> Appears when Obtain IP address automatically is set to **Off**.

#### IP Address

Set a fixed IP address to assign to the GX/GP.

#### Subnet mask

Set the subnet mask. Set this in accordance with the system or network that the GX/GP belongs to.

#### Default gateway

Set the IP address of the default gateway.

#### Automatic DNS settings<sup>1</sup>

Setup Item	Selectable Range or Options	Default Value
Obtain DNS address automatically	Off, On	Off

<sup>1</sup> Appears when Obtain IP address automatically is set to **On**.

#### Obtain DNS address automatically

Set this to **On** to automatically obtain the DNS server address. Otherwise, set this to **Off**. If you set this to **Off**, you need to set the primary and secondary DNS servers and domain suffixes.

## DNS settings<sup>1</sup>

Setup Item	Selectable Range or Options	Default Value
Primary DNS server	0.0.0.0 to 255.255.255.255	0.0.0.0
Secondary DNS server	0.0.0.0 to 255.255.255.255	0.0.0.0

<sup>1</sup> Appears when **Obtain DNS address automatically** is set to **Off**.

### Primary DNS server

Set the IP address of the primary DNS server.

### Secondary DNS server

Set the IP address of the secondary DNS server.

## Domain suffix

Setup Item	Selectable Range or Options	Default Value
Primary domain suffix	Character string (up to 64, <input type="text" value="Aa#1"/> )	—
Secondary domain suffix	Character string (up to 64, <input type="text" value="Aa#1"/> )	—

### Primary domain suffix

Set the primary domain name. You do not have to set this.

### Secondary domain suffix

Set the secondary domain name. You do not have to set this.

## Host settings

Setup Item	Selectable Range or Options	Default Value
Host name	Character string (up to 64, <input type="text" value="Aa#1"/> )	—
Domain name	Character string (up to 64, <input type="text" value="Aa#1"/> )	—

### Host name

Set the GX/GP host name.

### Domain name

Set the domain name of the network that the GX/GP belongs to. This is valid when Obtain DNS address automatically is set to **Off**.

## Host name registration<sup>1</sup>

Setup Item	Selectable Range or Options	Default Value
Host name registration	Off, On	Off

<sup>1</sup> Appears when **Obtain IP address automatically** is set to **On**.

### Host name registration

Set this to **On** to register the host name.

#### Note

For information on IP address, subnet mask, default gateway, DNS, and other settings, check with your network administrator.

## 1.21.2 Configuring the FTP Client Function

### Path

GX/GP: **MENU** key > **Browse** tab > **Setting** > Setting menu **Communication (Ethernet) settings > FTP client settings**

Web application: **Config.** tab > **Communication (Ethernet) settings > FTP client settings**

Hardware configurator: **Communication (Ethernet) settings > FTP client settings**

### Description

#### FTP client function

Setup Item	Selectable Range or Options	Default Value
On/Off	Off, On	Off

#### On/Off

Select **On** to use the FTP client function.

#### Transfer file<sup>1</sup>

Setup Item	Selectable Range or Options	Default Value
Display & Event data	Off, On	Off
Report	Off, On	Off
Manual sampled data	Off, On	Off
Alarm summary	Off, On	Off
Snap shot	Off, On	Off
Setting file <sup>2</sup>	Off, On	Off

<sup>1</sup> Appears when the FTP client function is set to On.

<sup>2</sup> Appears for the advanced security function (/AS option).

#### Display & Event data

Set this to **On** to automatically transfer display and event data files.

#### Report

Set this to **On** to automatically transfer report data files (including those based on report templates).

#### Manual sampled data

Set this to **On** to automatically transfer manual sampled data.

#### Alarm summary

Set this to **On** to automatically transfer alarm summaries.

#### Snap shot

Set this to **On** to automatically transfer snapshot data files.

#### Setting file (for the advanced security function (/AS option))

Set to **On** to automatically transfer the setting file when settings are changed.

#### Transfer wait time<sup>1</sup>

Setup Item	Selectable Range or Options	Default Value
Display & Event data	0 to 120 (minute)	0
Report	0 to 120 (minute)	0

<sup>1</sup> Appears when the FTP client function is set to **On**.

#### Display & Event data

Set the time to delay the data transfer to the FTP server.

#### Report

Set the time to delay the data transfer to the FTP server.



## Encryption (release number 2 and later)

Setup Item	Selectable Range or Options	Default Value
Encryption	Off, On	Off
Verification of certificate	Off, On	On

### Encryption

Set to **On** to encrypt using SSL the data transferred via FTP.

### Verification of Certificate

Set to **On** to verify the certificate received from the server using the certificate installed in the GX/GP.

## FTP connection Primary<sup>1</sup>

Setup Item	Selectable Range or Options	Default Value
FTP server name	Character string (up to 64, <b>[Aa#1]</b> )	—
Port number	Numeric value (1 to 65535)	21
User name	Character string (up to 32, <b>[Aa#1]</b> )	—
Password	Character string (up to 32, <b>[Aa#1]</b> )	—
Directory	Character string (up to 64, <b>[Aa#1]</b> )	—
PASV mode	Off, On	Off

<sup>1</sup> Appears when the FTP client function is set to **On**.

### FTP server name

Set the name of the FTP server to transfer files to.

If the DNS is available, you can set the host name as a server name.

You can also set the IP address. In this case, the DNS is not required.

- For details on DNS, see page 1-182 in section 1.21.1, “Setting Basic Communication Conditions”.

### Port number

Set the port number of the FTP server to transfer files to.

### User name

Set the user name (login name) for accessing the FTP server.

### Password

Set the password for accessing the FTP server.

### Directory

Set the directory of the file transfer destination. The delimiter for directories varies depending on the implementation of the destination FTP server.

Example: When transferring files to the “data” directory in the “home” directory of an FTP server on a UNIX file system.

/home/data

### PASV mode

Set this to **On** when using the GX/GP behind a firewall that requires the PASV mode.

## FTP connection Secondary

Configure the secondary FTP server. The settings are the same as those for “FTP connection Primary.”

### 1.21.3 Configuring the SMTP Client Function

#### Path

GX/GP: **MENU** key > **Browse** tab > **Setting** > Setting menu **Communication (Ethernet) settings** > **SMTP client settings**

Web application: **Config.** tab > **Communication (Ethernet) settings** > **SMTP client settings**

Hardware configurator: **Communication (Ethernet) settings** > **SMTP client settings**

#### Description

#### SMTP client function

Setup Item	Selectable Range or Options	Default Value
On/Off	Off, On	Off

#### On/Off

Select **On** to use the SMTP client function.

#### Authentication<sup>1</sup>

Setup Item	Selectable Range or Options	Default Value
Authentication	Off, SMTP Authentication, POP before SMTP, APOP	Off

<sup>1</sup> Appears when the SMTP client function is set to **On**. You cannot change this item from the Web browser.

#### Authentication

Set the authentication method for authenticated e-mail transmission.

#### Encryption<sup>1</sup> (release number 2 and later)

Setup Item	Selectable Range or Options	Default Value
Encryption	Off, On	Off
Verification of certificate	Off, On	On

<sup>1</sup> Appears when authentication is set to **Off** or **SMTP Authentication**.

#### Encryption

Set to **On** to encrypt using SSL the data transferred via SMTP.

#### Verification of Certificate

Set to **On** to verify the certificate received from the server using the certificate installed in the GX/GP.

#### SMTP server<sup>1</sup>

Setup Item	Selectable Range or Options	Default Value
SMTP server name	Character string (up to 64, <b>[Aa#1]</b> )	—
Port number	Numeric value (1 to 65535)	25
User name <sup>2</sup>	Character string (up to 32, <b>[Aa#1]</b> )	—
Password <sup>2</sup>	Character string (up to 32, <b>[Aa#1]</b> )	—

<sup>1</sup> Appears when the SMTP client function is set to **On**.

<sup>2</sup> Appears when authentication is set to **SMTP Authentication**.

#### SMTP server name

Set the host name or IP address of the SMTP server.

#### Port number

Set the port number to use. Unless specified otherwise, you do not need to change this number.

#### User name

Set the login name for accessing the server using SMTP authentication.

#### Password

Set the password for accessing the server using SMTP authentication.

**POP3 server<sup>1</sup>**

Setup Item	Selectable Range or Options	Default Value
POP3 server name	Character string (up to 64, <input type="text" value="Aa#1"/> )	—
Port number	Numeric value (0 to 65535)	110
User name <sup>2</sup>	Character string (up to 32, <input type="text" value="Aa#1"/> )	—
Password <sup>2</sup>	Character string (up to 32, <input type="text" value="Aa#1"/> )	—

1 Appears when the SMTP client function is set to **On**.

2 Appears when authentication is set to **POP Before SMTP** or **APOP**.

**POP3 server name**

If you need to use POP before SMTP, set the host name or IP address of the POP3 server.

**Port number**

Set the port number to use. Unless specified otherwise, you do not need to change this number.

**User name**

Set the login name for accessing the POP3 server.

**Password**

Set the login password for accessing the POP3 server.

**1.21.4 Setting E-mail Transmission Conditions (When the SMTP client function is on)**

Set the server configuration and the contents of the e-mail transmission.

► For the mail format, see page 3-64 in section 3.2.5, "E-mail Format".

**Path**

GX/GP: **MENU** key > **Browse** tab > **Setting** > Setting menu **Communication (Ethernet) settings** > **E-mail settings<sup>1</sup>**

Web application: **Config.** tab > **Communication (Ethernet) settings** > **E-mail settings**

Hardware configurator: **Communication (Ethernet) settings** > **E-mail settings**

1 Appears when the SMTP function is set to **On**.

**Description****Mail header**

Setup Item	Selectable Range or Options	Default Value
Recipient 1	Character string (up to 150, <input type="text" value="Aa#1"/> )	—
Recipient 2	Character string (up to 150, <input type="text" value="Aa#1"/> )	—
Sender	Character string (up to 64, <input type="text" value="Aa#1"/> )	—
Subject	Character string (up to 32, <input type="text" value="Aa#1"/> )	—

**Recipient 1**

Set the address of recipient 1. You can enter multiple e-mail address in a recipient box. When entering multiple addresses, delimit each address with a space.

**Recipient 2**

Set the address of recipient 2. You can enter multiple e-mail address in a recipient box. When entering multiple addresses, delimit each address with a space.

**Sender**

Set the sender address. Set this if necessary.

**Subject**

Set the subject of e-mails.

## 1.21 Configuring the Ethernet Communication Function

### E-mail contents

Setup Item	Selectable Range or Options	Default Value
Header	Character string (up to 128, $\boxed{\text{Aa\#1}}$ )	—
Include source URL	Off, On	Off

#### Header

Sets the mail header.

#### Include source URL

Set this to **On** to include the source URL. The URL is attached when the Web server is enabled.

### Alarm settings

Setup Item	Selectable Range or Options	Default Value
Alarm notification	Off, Recipient 1, Recipient 2, Recipient 1 & Recipient 2	Off
Detection <sup>1, 4</sup>	Channel, Alarm level	Channel
Channel set <sup>2</sup>	Up to 50 channels; I/O channels, Math channels, Communication channels	—
Detection alarm level 1 <sup>3, 4</sup>	Off, On	Off
Detection alarm level 2 <sup>3, 4</sup>	Off, On	Off
Detection alarm level 3 <sup>3, 4</sup>	Off, On	Off
Detection alarm level 4 <sup>3, 4</sup>	Off, On	Off
Attach instantaneous data <sup>1</sup>	Off, On	Off
Send alarm action <sup>1</sup>	Occurrence & Release, Occurrence	Occurrence & Release
Include tag/ch in Subject <sup>1</sup>	Off, On	Off

- 1 You can set this when Alarm notification is not set to **Off**.
- 2 You can set this when the Detection is set to **Channel**.
- 3 You can set this when the Detection is set to **Alarm level**.
- 4 Release number 3 and later

#### Alarm notification

Set the recipients that will receive e-mails when alarms occur and are released.

When the future pen function is set, a future alarm mail is sent when a future alarm occurs or is released. The detection of the future alarm uses the alarm condition of the channel set in the future pen.

► For future alarm, refer to page 1-284 in section 1.33.2, "Using Future Alarm".

#### Detection

Set the type for detecting alarm occurrence and release.

#### Channel set

Set the source channel for detecting alarm occurrence and release.  
You cannot specify a channel of an AO module or PID control module.

#### Detection alarm level 1 to 4

Set the alarm level for detecting alarm occurrence and release.

The setting applies to all channels.

Alarm notification mail is not sent when a control alarm occurs or is released.

#### Attach instantaneous data

Set this to **On** to include instantaneous data. The data that is attached is the instantaneous value at the time an e-mail is transmitted.

#### Send alarm action

Set the type of alarm notification mail to transmit.

#### Include tag/ch in Subject

Set this to **On** to include the channel number and tag of the alarm detection channel in the subject.

## Report settings

Setup Item	Selectable Range or Options	Default Value
Report notification	Off, Recipient 1, Recipient 2, Recipient 1 & Recipient 2	Off

### Report notification

Set the recipients that will receive report e-mails.

## Scheduled settings

Setup Item	Selectable Range or Options	Default Value
Scheduled notification	Off, Recipient 1, Recipient 2, Recipient 1 & Recipient 2	Off
Attach instantaneous data	Off, On	Off
Interval (Recipient 1)	1h, 2h, 3h, 4h, 6h, 8h, 12h, 24h	24h
Ref. time hour (Recipient 1)	0 to 23	0
Ref. time minute (Recipient 1)	0 to 59	0
Interval (Recipient 2)	1h, 2h, 3h, 4h, 6h, 8h, 12h, 24h	24 h
Ref. time hour (Recipient 2)	0 to 23	0
Ref. time minute (Recipient 2)	0 to 59	0

### Scheduled notification

Set the recipients that will receive scheduled e-mail transmissions.

### Attach instantaneous data

Set this to **On** to include instantaneous data. The data that is attached is the instantaneous value at the scheduled times.

### Interval (Recipient 1)

Set the interval for transmitting e-mails to recipient 1.

### Ref. time hour, Ref. time minute (Recipient 1)

Set the time used as a reference for sending e-mails at specific intervals to Recipient 1.

### Interval (Recipient 2)

Set the interval for transmitting e-mails to recipient 2.

### Ref. time hour, Ref. time minute (Recipient 2)

Set the time used as a reference for sending e-mails at specific intervals to Recipient 2.

## System settings

Setup Item	Selectable Range or Options	Default Value
Memory full notification	Off, Recipient 1, Recipient 2, Recipient 1 & Recipient 2	Off
Power failure notification	Off, Recipient 1, Recipient 2, Recipient 1 & Recipient 2	Off
System error notification	Off, Recipient 1, Recipient 2, Recipient 1 & Recipient 2	Off
User lockout notification <sup>1</sup>	Off, Recipient 1, Recipient 2, Recipient 1 & Recipient 2	Off

<sup>1</sup> Appears for the advanced security function (/AS option).

### Memory full notification

Sends a message when the free space on the external storage medium or internal memory is low.

► For details, see page 1-211 in section 1.23.6, "Setting the FAIL Relay and Instrument Information Output (/FL option)"

### Power failure notification

Set recipients if you want e-mails to be sent when the GX/GP is powered on or recovers from a power failure.

### System error notification

Set recipients if you want e-mails to be sent when system errors occur.

## 1.21 Configuring the Ethernet Communication Function

### User Lockout Notification (for the advanced security function (/AS option))

Set recipients if you want an e-mail to be sent when a user lock out (user invalidation) occurs.

### Mail Format

► See page 3-64 in section 3.2.5, "E-mail Format".

## 1.21.5 Setting the SNTP Client Function

Set the function used to query the time information server on the network for the time and synchronize the time.

### Path

GX/GP: **MENU** key > **Browse** tab > **Setting** > Setting menu **Communication (Ethernet) settings** > **SNTP client settings**

Web application: **Config.** tab > **Communication (Ethernet) settings** > **SNTP client settings**

Hardware configurator: **Communication (Ethernet) settings** > **SNTP client settings**

### Description

#### SNTP client function

Setup Item	Selectable Range or Options	Default Value
On/Off	Off, On	Off

#### On/Off

Select **On** to use the SNTP client function.

#### SNTP server<sup>1</sup>

Setup Item	Selectable Range or Options	Default Value
SNTP server name	Character string (up to 64 characters, <b>Aa#1</b> )	—
Port number	Numeric value (1 to 65535)	123

<sup>1</sup> Appears when the SNTP client function is set to **On**.

#### SNTP server name

Set the SNTP server name.

If the DNS is available, you can set the host name as a server name.

You can also set the IP address. In this case, the DNS is not required.

► For details on DNS, see page 1-182 in section 1.21.1, "Setting Basic Communication Conditions".

#### Port number

Set the port number of the SNTP server. Unless specified otherwise, you do not need to change this number.

**Query action<sup>1</sup>**

Setup Item	Selectable Range or Options	Default Value
Ref. time (Hour)	0 to 23	0
Ref. time (Minute)	0 to 59	0
Interval	6h, 12h, 24h	6 h
Timeout	10s, 30s, 90s	30s
Time adjust on Start action	Off, On	Off

<sup>1</sup> Appears when the SNTP client function is set to **On**.

**Ref. time (Hour), Ref. time (Minute)**

Set the reference time for making queries.

**Interval**

Set the time interval for synchronizing the time with the server. The time is not synchronized if the difference in the time between the GX/GP and the server is greater than equal to the value specified in **System settings > Time basic settings > Time deviation limit**.

**Timeout**

Set the time to wait for the response from the SNTP server when querying the time.

**Time adjust on Start action**

Set this to **On** to synchronize the time using SNTP when recording is started. When set to **ON**, the clock is adjusted when recording starts and when the GX/GP recovers from power failures when recording is in progress.

## 1.21.6 Configuring the Modbus Client Function (Option, Function available when /MC is specified)

### Configuring Basic Settings

#### Path

GX/GP: **MENU** key > **Browse** tab > **Setting** > Setting menu **Communication (Ethernet) settings > Modbus client settings > Basic settings**

Web application: **Config.** tab > **Communication (Ethernet) settings > Modbus client settings**

Hardware configurator: **Communication (Ethernet) settings > Modbus client settings**

#### Description

**Modbus client function**

Setup Item	Selectable Range or Options	Default Value
On/Off	Off, On	Off

**On/Off**

Select **On** to use the Modbus client function.

**Communication<sup>1</sup>**

Setup Item	Selectable Range or Options	Default Value
Interval	100ms, 200ms, 500ms, 1s, 2s, 5s, 10s, 20s, <sup>2</sup> 30s, <sup>2</sup> 1 min <sup>2</sup>	1 s

<sup>1</sup> Appears when the Modbus client function is set to **On**.

<sup>2</sup> Release number 2 and later.

**Interval**

Set the communication interval.

## 1.21 Configuring the Ethernet Communication Function

### Recovery action<sup>1</sup>

Setup Item	Selectable Range or Options	Default Value
Wait time	Off, 5s, 10s, 30s, 1min, 2min, 5min	2min

<sup>1</sup> Appears when the Modbus client function is set to **On**.

#### Wait time

Set the interval for retrying the connection when the connection is interrupted for some reason. Set this to **Off** to not retry connections.  
If communication fails, communication stops.

### Connection<sup>1</sup>

Setup Item	Selectable Range or Options	Default Value
Keep connection	Off, On	Off
Connection timeout <sup>2</sup>	1 to 10 (s)	1

<sup>1</sup> Appears when the Modbus client function is set to **On**.

<sup>2</sup> Appears when Keep connection is set to **On**.

#### Keep connection

Set this to **On** to maintain the connection with the external device.

#### Connection timeout

If you set Keep connection to **On**, set the duration to maintain the TCP connection with the external Modbus device.

### Explanation

#### Keep connection

Set whether to connect and disconnect TCP connections every time the GX/GP accesses an external device.

If you set Keep connection to **On**, the TCP connection/disconnection procedure is skipped, thereby reducing the amount of communication traffic between the devices.

However, some devices do not support this feature. Use this feature after you check the specifications of the connected devices.

Even if Keep connection is set to **OFF**, if the communication interval is less than 1 s, communication is performed as if Keep connection set to **ON**.

## Configuring the Destination Server

### Path

GX/GP: **MENU** key > **Browse** tab > **Setting** > Setting menu **Communication (Ethernet) settings** > **Modbus client settings** > **Modbus server settings**

Web application: **Config.** tab > **Communication (Ethernet) settings** > **Modbus server settings**

Hardware configurator: **Communication (Ethernet) settings** > **Modbus server settings**

### Description

Setup Item	Selectable Range or Options	Default Value
Server number	GX20-1/GP20-1: 1 to 16 GX20-2/GP20-2: 1 to 32 GX10/GP10: 1 to 16	1

#### Server number

Set the registration number of the server.



## Modbus server settings

Setup Item	Selectable Range or Options	Default Value
Server name	Character string (up to 64 characters, <b>Aa#1</b> )	—
Port number	Numeric value (1 to 65535)	502

### Server name

Set the destination Modbus server name.  
If the DNS is available, you can set the host name as a server name.  
You can also set the IP address. In this case, the DNS is not required.

### Port number

Set the port number of the selected server.  
Unless specified otherwise, you do not need to change this number.

## Setting Commands

### Path

GX/GP: **MENU** key > **Browse** tab > **Setting** > Setting menu **Communication (Ethernet) settings > Modbus client settings > Command settings**  
Web application: **Config.** tab > **Communication (Ethernet) settings > Modbus client command settings > Client command number (display example: 1-20)**  
Hardware configurator: **Communication (Ethernet) settings > Modbus client command settings > Client command number (display example: 1-20)**

### Description

Setup Item	Selectable Range or Options	Default Value
Client command number	GX20-1/GP20-1: 1 to 100 GX20-2/GP20-2: 1 to 200 GX10/GP10: 1 to 50	1

### Client command number

Select the transmission command number you want to set.

## Command setting

Setup Item	Selectable Range or Options	Default Value
Type	Off, Read, Write	Off
Server <sup>1</sup>	GX20-1/GP20-1: 1 to 16 GX20-2/GP20-2: 1 to 32 GX10/GP10: 1 to 16	1
Unit No. <sup>1</sup>	1 to 255	255
Data type <sup>1</sup>	INT16, UINT16, INT32_B, INT32_L, UINT32_B, INT16 UINT32_L, FLOAT_B, FLOAT_L, BIT	
Register <sup>1</sup>	1 to 9999, 10001 to 19999, 100001 to 165535 30001 to 39999, 300001 to 365536 40001 to 49999, 400001 to 465536	40001
Channel type <sup>1</sup>	Read: Communication channel Write: IO channel, Math channel, Communication channel	Read: Communication channel Write: I/O channel
First-CH <sup>1</sup>	Same as the channel type	1
Last-CH <sup>1</sup>	Same as the channel type	1

<sup>1</sup> Appears when the type is not set to **Off**.

## 1.21 Configuring the Ethernet Communication Function

### Type

Set the command type.

### Server

Set the server number.

### Unit No.

Set the fixed port number.

The unit number is used to specify a device connected through the Modbus gateway function.

To connect to the Modbus/TCP master of a UTAdvanced series, set the unit number to 1.

### Data type

Set the data type. The data types that you can specify vary depending on the type of command. ► See page 4-11 in section 4.5, "Modbus Function and Register Assignments"

### Register

Set the register number of the server.

You can specify an input register in the range of 30001 to 39999 or 300001 to 365536. You can specify a hold register in the range of 40001 to 49999 or 400001 to 465536.

The register numbers that you can specify vary depending on the type of command.

### Channel type

When the type is set to **Read**, only communication channels are available.

When the type is set to **Write**, set the channel type of the data to send.

### First-CH, Last-CH

Set the first channel number and the last channel number in accordance with the channel type.

## 1.21.7 Configuring the Server Function

### Path

GX/GP: **MENU** key > **Browse** tab > **Setting** > Setting menu **Communication (Ethernet) settings** > **Server settings** > **Server function**

Web application: **Config.** tab > **Communication (Ethernet) settings** > **Server function**

Hardware configurator: **Communication (Ethernet) settings** > **Server function**

### Description

#### Keep alive function

Setup Item	Selectable Range or Options	Default Value
On/Off	Off, On	On

#### On/Off

Set this to **On** to disconnect when there is no response to test packets that are periodically sent. Otherwise, set this to **Off**.

#### Timeout function

Setup Item	Selectable Range or Options	Default Value
On/Off	Off, On	Off
Timeout (minute)	1 to 120	1

#### On/Off

Select **On** to use the communication timeout function.

#### Timeout (minute)

Set the timeout value.

## FTP server

Setup Item	Selectable Range or Options	Default Value
Output Directory Format	MS-DOS, UNIX	UNIX

### Output Directory Format

Sets the directory output format.

## Modbus server

Setup Item	Selectable Range or Options	Default Value
Modbus delay response	Off, 10ms, 20ms, 50ms	Off

### Modbus delay response

To delay the responses to queries from the client, set the response delay value.

## 1.21.8 Limiting the Connection to the Modbus Server (GX/GP)

### Path

GX/GP: **MENU** key > **Browse** tab > **Setting** > Setting menu **Communication (Ethernet) settings** > **Server settings** > **Allowed Modbus clients**

Web application: **Config.** tab > **Communication (Ethernet) settings** > **Allowed Modbus clients**

Hardware configurator: **Communication (Ethernet) settings** > **Allowed Modbus clients**

### Description

## Modbus client connect limits function

Setup Item	Selectable Range or Options	Default Value
On/Off	Off, On	Off

### On/Off

Set this to **On** to limit the IP addresses that can connect to the GX/GP Modbus server function. IP addresses other than those specified here will not be able to connect. To not limit connections, set this to **Off**.

## 1 to 10

Setup Item	Selectable Range or Options	Default Value
On/Off	Off, On	Off
IP Address	Numerical value (0.0.0.0 to 255.255.255.255)	0.0.0.0

### On/Off

Set this to **On** to set the IP addresses to allow connections. You can register up to 10 IP addresses.

### IP Address

Set the IP addresses to allow connection (0.0.0.0 to 255.255.255.255). You cannot specify host names.

### 1.21.9 Setting the Server Functions to Use (FTP, HTTP, SNTP, MODBUS, GENE, DARWIN compatible communication)

For the OPC-UA server settings (OPC-UA server (/E3 option)), see the OPC-UA Server (/E3) User's Manual (IM 04L51B-20EN).

**Path**

GX/GP: **MENU** key > **Browse** tab > **Setting** > Setting menu **Communication (Ethernet) settings > Server settings > Server list**  
 Web application: **Config.** tab > **Communication (Ethernet) settings > Server list**  
 Hardware configurator: **Communication (Ethernet) settings > Server list**

**Description**

**FTP**

Setup Item	Selectable Range or Options	Default Value
On/Off	On, Off	On
Encryption	On, Off	Off
Port number	Numeric value (1 to 65535)	21

**On/Off**

Select **On** to use the FTP server function.

**Encryption (release number 2 and later)**

Set to **On** to encrypt using SSL the data exchanged via FTP.

You need to create a key and a certificate.

- ▶ See page 1-260 in section 1.30, "Configuring Key Creation, Certificate Management, and Encryption/Certificate (SSL communication, PDF electronic signature) (Release number 2 and later)".

**Note**

Note that even if FTP encryption is set to On, when FTP download is performed from the Web application, the user name and password will not be encrypted.

**Port number**

Set the port number of the FTP server. Unless specified otherwise, you do not need to change this number.

**HTTP**

Setup Item	Selectable Range or Options	Default Value
On/Off	On, Off	On
Encryption	On, Off	Off
Port number	Numeric value (1 to 65535)	80

**On/Off**

Select **On** to use the Web server function.

**Encryption (release number 2 and later)**

Set to **On** to encrypt using SSL the data exchanged via HTTP.

You need to create a key and a certificate.

- ▶ See page 1-260 in section 1.30, "Configuring Key Creation, Certificate Management, and Encryption/Certificate (SSL communication, PDF electronic signature) (Release number 2 and later)".

**Port number**

Set the port number of the HTTP server. Unless specified otherwise, you do not need to change this number.

If encryption is set to On, the port number will be set to 443.

## SNTP

Setup Item	Selectable Range or Options	Default Value
On/Off	On, Off	Off
Port number	Numeric value (1 to 65535)	123

### On/Off

Select **On** to use the SNTP server function.

### Port number

Set the SNTP port number. Unless specified otherwise, you do not need to change this number.

## MODBUS

Setup Item	Selectable Range or Options	Default Value
On/Off	On, Off	Off
Port number	Numeric value (1 to 65535)	502

### On/Off

Select **On** to use the Modbus server function.

### Port number

Set the port number of the Modbus server. Unless specified otherwise, you do not need to change this number.

## GENE

Setup Item	Selectable Range or Options	Default Value
On/Off	On, Off	On
Port number	Numeric value (1 to 65535)	34434

### On/Off

Select **On** to use the general purpose communication.

General purpose communication is a function for communicating with the GX/GP using dedicated commands.

### Port number

Set the port number to use for general purpose communication. Unless specified otherwise, you do not need to change this number.

## DARWIN (Release number 2 and later)

Setup Item	Selectable Range or Options	Default Value
On/Off	On, Off	Off
Channel conversion	Stand-alone type, extended type	Stand-alone type

### On/Off

Select **On** to use DARWIN compatible communication.

### Channel Conversion

Set the DARWIN model type.

The model type, channel number, and relay number are converted as follows.

### Note

////////////////////////////////////  
 The channel conversion setting is shared with the channel conversion setting set with DARWIN in page 1-200 in section 1.22.1, "Setting Basic Communication Conditions". Changing this setting will also change the channel conversion setting set with DARWIN in 1.22.1, "Setting Basic Communication Conditions".  
 //////////////////////////////////////

## 1.21 Configuring the Ethernet Communication Function

---

### Stand-alone type

	DARWIN ↔ GX/GP	Example
Channel number	0xx — 0?0 ↔ 0x0x — 0x?0	031 ↔ 0301, 040 ↔ 0310
Relay number	0xx — 0?0 ↔ 0x0x — 0x?0	031 ↔ 0301, 040 ↔ 0310

### Extended type

	DARWIN ↔ GX/GP	Example
Channel number	0xx — 5?0 ↔ 1x0x — 6x?0	031 ↔ 1301, 040 ↔ 1310
Relay number	lxx — l?0 ↔ 0x0x — 0x?0	l31 ↔ 0301, l40 ↔ 0310

- ▶ For details on the DARWIN compatible communication function, see page 1-267 in section 1.31, “Using the DARWIN Compatible Communication Function (Release number 2 and later)”.

### Note

////////////////////////////////////  
The following numbers cannot be used for the port number of any of the server functions.  
44818, 2222, 34150, 34151, 34437  
////////////////////////////////////

## 1.21.10 Setting the Web Content Selection Tree (release number 3 and later)

### Path

GX/GP: **MENU** key > **Browse** tab > **Setting** > Setting menu **Communication (Ethernet) settings > Server settings > Web contents selection**

Web application: **Config.** tab > **Communication (Ethernet) settings > Server settings Web contents selection**

Hardware configurator: **Communication (Ethernet) settings > Server settings Web contents selection**

### Description

You can set whether to show or hide some of the contents shown on the Data tab of the Web application.

- When Communication of the security function is set to Login, only administrators can use this feature.
- When the Communication of the security function is set to Off, there are no restrictions on using this feature.

### When the user level is User

Setup Item	Selectable Range or Options	Default Value
DO Channel Status/COMM status	Off, On	On
Log	Off, On	On
System information/Network information	Off, On	On
File	Off, On	On

#### DO Channel Status/COMM status

Set this to Off to hide the following contents on the Data tab.

DO channel, Internal switch, Modbus master, Modbus client, WT client, SLMP client

#### Log

Set this to Off to hide the log on the Data tab.

#### System information/Network information

Set this to Off to hide the system information and network information on the Data tab.

#### File

Set this to Off to hide Memory summary/Save, Report, Manual sample, Save/load on the Data tab.

### When the user level is Monitor <sup>1</sup>

Setup Item	Selectable Range or Options	Default Value
DO Channel Status/COMM status	Off, On	On
Log	Off, On	On
System information/Network information	Off, On	On
File	Off, On	On

<sup>1</sup> You can set this when you are using the advanced security function (/AS option).

The settings are the same as those of the User user level except that Save/Load on the Data tab does not appear even if File is set to On.

## 1.22 Configuring the Serial Communication Function (/C2 and /C3 options)

Set serial communication parameters.

### 1.22.1 Setting Basic Communication Conditions

#### Path

GX/GP: **MENU** key > **Browse** tab > **Setting** > **Communication (Serial) settings** > **Basic settings**

Web application: **Config.** tab > **Communication (Serial) settings** > **Serial basic settings**

Hardware configurator: **Communication (Serial) settings** > **Serial basic settings**

#### Description

#### Receiver

Setup Item	Selectable Range or Options	Default Value
Function	Off, Normal, Modbus master (/MC option), Modbus slave, Bar-code <sup>1</sup> , DARWIN <sup>2</sup>	Normal
Address	When the function is Normal or DARWIN: 1 to 99 Other than Normal or DARWIN: 1 to 247	1

<sup>1</sup> Release number 2 and later.

<sup>2</sup> Release number 2 (version 2.02) and later

#### Function

Set the function to use. To use general purpose communication, select **Normal**.

To execute communication commands with a barcode reader, select **Bar-code**. A portion of the control and output communication commands can be executed.

The commands that can be executed are the same as those of the USB keyboard. For details, see page 1-216 in section 1.23.11, "Setting USB Input Devices (/UH option)".

#### Address

Set the GX/GP address.

Function	Selectable Range or Options
Normal/DARWIN	1 to 99
Modbus master, Modbus slave	1 to 247

#### Data transfer

Setup Item	Selectable Range or Options	Default Value
Baud rate	1200, 2400, 4800, 9600, 19200, 38400, 57600, 115200 (bps)	9600
Parity bit	None, Even, Odd	Even
Stop bit	1bit, 2bit	1bit
Data length	7bit, 8bit	8bit
Handshake <sup>1</sup>	Off:Off, XON:XON, XON:RS, CS:RS	Off:Off

<sup>1</sup> Does not appear for RS-422/485 (/C3 option)

#### Baud rate

Set the baud rate.

#### Parity bit

Set the parity check method.

#### Stop bit

Set the stop bits.

#### Data length

Set the data length. To output the data in binary format, select **8bit**.

#### Handshake

Set the handshaking method.



**Logout<sup>1</sup> (Release number 2 and later)**

Setup Item	Selectable Range or Options	Default Value
Auto logout	Off, 1min, 2min, 5min, 10min	Off

- <sup>1</sup> Appears when the receiver function is set to **Normal**, and in the security settings, communication is set to **Login**.

**Auto Logout**

Options	Description
Off	Stays logged in until the user logs out.
1min to 10min	When you log in through serial communication, you will be automatically logged out when there is no communication control for the specified duration.

**DARWIN<sup>1</sup> (Release number 2 (version 2.02)) and later)**

Setup Item	Selectable Range or Options	Default Value
Channel conversion	Stand-alone type, extended type	Stand-alone type

- <sup>1</sup> Appears when the receiver function is set to **DARWIN**.

**Channel Conversion**

Set the DARWIN model type.

The model type, channel number, and relay number are converted as follows.

**Stand-alone type**

	DARWIN ↔ GX/GP	Example
Channel number	0xx — 0?0 ↔ 0x0x — 0x?0	031 ↔ 0301, 040 ↔ 0310
Relay number	0xx — 0?0 ↔ 0x0x — 0x?0	031 ↔ 0301, 040 ↔ 0310

**Extended type**

	DARWIN ↔ GX/GP	Example
Channel number	0xx — 5?0 ↔ 1x0x — 6x?0	031 ↔ 1301, 040 ↔ 1310
Relay number	lxx — l?0 ↔ 0x0x — 0x?0	l31 ↔ 0301, l40 ↔ 0310

**Note**

The channel conversion setting is shared with the channel conversion setting set with DARWIN in page 1-196 in section 1.21.9, "Setting the Server Functions to Use (FTP, HTTP, SNTP, MODBUS, GENE, DARWIN compatible communication)". Changing this setting will also change the channel conversion setting set with DARWIN in 1.21.9, "Setting the Server Functions to Use (FTP, HTTP, SNTP, MODBUS, GENE, DARWIN compatible communication)".

- For details on the DARWIN compatible communication function, see page 1-267 in section 1.31, "Using the DARWIN Compatible Communication Function (Release number 2 and later)".

## 1.22.2 Enabling or Disabling the Modbus Master Function (/MC option) and Setting Communication Conditions

### Path

GX/GP: **MENU** key > **Browse** tab > **Setting** > Setting menu **Communication (Serial) settings** > **Modbus master** > **Basic settings**

Web application: **Config.** tab > **Communication (Serial) settings** > **Modbus master Basic settings**

Hardware configurator: **Communication (Serial) settings** > **Modbus master Basic settings**

### Description

#### Master function

Setup Item	Selectable Range or Options	Default Value
On/Off	Off, On	Off

#### On/Off

Select **On** to use the Modbus master function.

#### Communication

Setup Item	Selectable Range or Options	Default Value
Interval	100ms, 200ms, 500ms, 1s, 2s, 5s, 10s, 20s, 30s, 1min	1s
Communication timeout	100ms, 200ms, 250ms, 500ms, 1s, 2s, 5s, 10s, 1min	1s
Gap between messages	Off, 5ms, 10ms, 20ms, 50ms, 100ms	Off

#### Interval

Set the data read cycle.

#### Communication timeout

Set the timeout value for the response from the specified slave when a command is sent from the GX/GP.

#### Gap between messages

Set the amount of time to wait after receiving a response to a command to send the next command.

To connect a UTAdvanced series, set the gap between messages to 20 ms.

#### Recovery action

Setup Item	Selectable Range or Options	Default Value
Retry	Off, Once, Twice, 3 times, 4 times, 5 times, 10 times, 20 times	Once
Wait time	Off, 5s, 10s, 30s, 1min, 2min, 5min	5s

#### Retransmission

Set the number of retransmissions when there is no response from the slave device.

#### Wait time

Set the auto recovery time from communication halt.

### 1.22.3 Setting Modbus Master Transmission Commands

#### Path

GX/GP: **MENU** key > **Browse** tab > **Setting** > Setting menu **Communication (Serial) settings > Modbus master > Command settings**

Web application: **Config.** tab > **Communication (Serial) settings > Modbus master Command settings > Master command number (display example: 1-20)**

Hardware configurator: **Communication (Serial) settings > Modbus master Command settings > Master command number (display example: 1-20)**

#### Description

Setup Item	Selectable Range or Options	Default Value
Master command number	GX20/GP20: 1 to 100 GX10/GP10: 1 to 50	1

#### Master command number

Select the command number you want to set.

#### Command settings

Setup Item	Selectable Range or Options	Default Value
Type	Off, Read, Write	Off
Slave <sup>1</sup>	1 to 247	1
Data type <sup>1</sup>	INT16, UINT16, INT32_B, INT32_L, UINT32_B, INT16 UINT32_L, FLOAT_B, FLOAT_L, BIT	
Register <sup>1</sup>	1 to 9999, 10001 to 19999, 100001 to 165535 30001 to 39999, 300001 to 365536 40001 to 49999, 400001 to 465536	30001
Channel type <sup>1</sup>	Read: Communication channel Write: IO channel, Math channel, Communication channel	Communication channel
First-CH <sup>1</sup>	Channel of the channel type	—
Last-CH <sup>1</sup>	Channel of the channel type	—

<sup>1</sup> Appears when the type is not set to **Off**.

#### Type

Set the transmission command operation.

#### Slave

Set the address of the slave device.

#### Data type

Set the data type.

The data types that you can specify vary depending on the type of command. For information on the workflow, see page 4-11 in section 4.5, "Modbus Function and Register Assignments".

## 1.22 Configuring the Serial Communication Function (/C2 and /C3 options)

---

### **Register**

Set the register number of the slave.

You can specify an input register in the range of 30001 to 39999 or 300001 to 365536. You can specify a hold register in the range of 40001 to 49999 or 400001 to 465536.

The register numbers that you can specify vary depending on the type of command. See page 4-11 in section 4.5, "Modbus Function and Register Assignments".

### **Channel type**

When the type is set to **Read**, only communication channels are available.

When the type is set to **Write**, set the channel type of the data to send.

### **First-CH, Last-CH**

Set the first channel number and the last channel number in accordance with the channel type.

## 1.23 Configuring System Settings (Time zone, display language, status relay, etc.)

Set the system environment such as the time zone and display language.

### 1.23.1 Setting the Display Language, Temperature Unit, Decimal Point Type, and Date Format

#### Path

GX/GP: **MENU** key > **Browse** tab > **Setting** > Setting menu **System settings** > **Environment (Language) settings**

Web application: **Config.** tab > **System settings** > **Environment (Language) settings**

Hardware configurator: **System settings** > **Environment (Language) settings**

#### Description

Setup Item	Selectable Range or Options	Default Value
Language	Japanese, English, German, French, Russian, Chinese, Korean, Italian	English
Temperature unit	C, F	C
Decimal Point Type	Point, Comma	Point

#### Language

Set the language to use.

#### Note

When you tap **Save** after changing the language, the message "Restart is required to reflect this changes. Continue?" may appear. Tap **OK**, and the GX/GP will automatically restart with the specified language.

#### Temperature unit

Set the temperature unit.

#### Decimal Point Type

Set the decimal point type.

Options	Display Example
Point	1234.56
Comma	1234,56

This is applied to the following files and displays. The decimal point of any file or setting not listed below (the setup screen for example) is displayed using a period.

Type	Item
File output	Manual sampled data file Report file Printer output
Screen	Trend display Digital display Bar graph display Overview display Historical trend Multi panel Report data display Control group Control overview Program operation
E-mail	The instantaneous value data in alarm e-mails and scheduled e-mails. The report data in report e-mails

#### Date format

Setup Item	Selectable Range or Options	Default Value
Date format	Year Month Day, Month Day Year, Day Month Year	Year, month, day
Delimiter	Slash (/), Point (.), Hyphen (-)	Slash (/)
Month indicator	Characters, Numerical	Numerical

## 1.23 Configuring System Settings (Time zone, display language, status relay, etc.)

### Date format

Set the date display format.

Options	Display example <sup>1</sup>
Year Month Day	2012/12/30
Month Day Year	12/30/2012
Date Month Year	30/12/2012

<sup>1</sup> In the display examples, the delimiter is a slash (/).

### Scope

The format is applied to the date displayed on the screen. It does not change the date format on the date in the output data via communications, the date saved along with the data, and the date used in the data file names.

### Delimiter

Set the date delimiter.

### Month indicator

Set whether to spell out months or use numbers on the screen.

## 1.23.2 Setting the Interval for Calculating the Rate-of-Change for Rate-of-Change Alarms

### Path

GX/GP: **MENU** key > **Browse** tab > **Setting** > Setting menu **System settings** > **Alarm basic settings**

Web application: **Config.** tab > **System settings** > **Alarm basic settings**

Hardware configurator: **System settings** > **Alarm basic settings**

### Description

#### Rate of change

Setup Item	Selectable Range or Options	Default Value
Decrease	1 to 32	1
Increase	1 to 32	1

#### Decrease

Set the interval for the rate-of-change computation of the low limit on rate-of-change alarm in terms of the number of measured data values (1 to 32).<sup>1</sup> The actual interval is obtained by multiplying the value specified here by the scan interval.

<sup>1</sup> The number of measured data values is the number of samples.

#### Increase

Set the interval for the rate-of-change computation of the high limit on rate-of-change alarm in the same manner as the interval for the low limit on rate-of-change alarm.

### 1.23.3 Setting the Alarm Display Hold/Nonhold and Individual Alarm ACK Operation

#### Path

GX/GP: **MENU** key > **Browse** tab > **Setting** > Setting menu **System settings** > **Alarm basic settings**

Web application: **Config.** tab > **System settings** > **Alarm basic settings**

Hardware configurator: **System settings** > **Alarm basic settings**

#### Description

##### Indicator

Setup Item	Selectable Range or Options	Default Value
Hold/Nonhold	Hold/Nonhold	Nonhold

##### Hold/Nonhold

Set the alarm display behavior. This applies to both measurement alarms and control alarms.

Options	Description
Nonhold	Clears the alarm indication when the alarm condition is released (returns to normal condition).
Hold	Holds the alarm indication until an alarm acknowledge operation is performed.

##### Alarm ACK (Release number 2 and later)

Setup Item	Selectable Range or Options	Default Value
Individual alarm ACK	Off, On	Off

##### Individual alarm ACK

Set to **On** to perform individual alarm acknowledge.

You can acknowledge alarms separately by channel and level.

If set to **On**, Display settings are automatically set **Hold**.

The Relay Action on ACK of all DO channels when an acknowledge is performed is **Reset**.  
Relay Action on ACK when the range type is set to **Alarm** in the DO settings of control settings is also set to **Reset**.

### 1.23.4 Setting the Time Zone, Gradual Time Adjustment, and Daylight Saving Time

#### Path

GX/GP: **MENU** key > **Browse** tab > **Setting** > Setting menu **System settings** > **Time basic settings**

Web application: **Config.** tab > **System settings** > **Time basic settings**

Hardware configurator: **System settings** > **Time basic settings**

#### Description

##### Time zone

Setup Item	Selectable Range or Options	Default Value
Hour	-13 to 13	9
Minute	0 to 59	0

##### Hour, Minute

Set the time zone of the region in which the GX/GP will be used in terms of the time difference from GMT. A negative value indicates that the local time is behind the GMT.

Example: The standard time in Japan is ahead of the GMT by 9 hours. In this case, set **Hour** to **9** and **Minute** to **0**.

### Gradually adjusting the time

Setup Item	Selectable Range or Options	Default Value
Time deviation limit	Off, 5s, 10s, 15s	5s
Time adjustment beyond limit	Not Change the time/Change the time	Not Change the time

#### Time deviation limit

To gradually correct the time when the time is changed while recording is in progress, set the deviation limit for gradually correcting the time. Only when the time deviation between the GX/GP's time and the specified time is within  $\pm$ (the value that you specify here) is the GX/GP's time gradually corrected. Otherwise, the time is corrected according to **Time adjustment beyond limit**.

Options	Description
5 s to 15 s	The time deviation limit.
Off	Disables the function that gradually corrects the time.

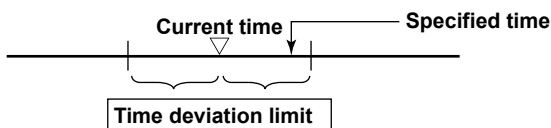

#### Time adjustment beyond limit

Set the behavior when a time that exceeds the time deviation limit is specified.

Options	Description
Not Change the time	Time is not corrected.
Change the time	Time is immediately corrected.

### Daylight Saving Time

Setup Item	Selectable Range or Options	Default Value
Use/Not	Not, Use	Not

#### Use/Not

Set this to **On** to set Daylight Saving Time.

#### Start time<sup>1</sup>

Setup Item	Selectable Range or Options	Default Value
Month	January to December	March
Day order	1st, 2nd, 3rd, 4th, Last	2nd
Day of the week	Sunday to Saturday	Sunday
Hour of the day	0 to 23	2

<sup>1</sup> Appears when DST (Daylight Saving Time) Use/Not is set to **On**.

#### Month, Day order, Day of the week, Hour of the day

Set the date and time when daylight saving time starts.

Setup Item	Description
Month	Set the month.
Day order	Set the week in the month.
Day of the week	Set the day of the week.
Hour of the day	Set the hour. 0 to 23.



### End time<sup>1</sup>

Setup Item	Selectable Range or Options	Default Value
Month	January to December	November
Day order	1st, 2nd, 3rd, 4th, Last	1st
Day of the week	Sunday to Saturday	Sunday
Hour of the day	0 to 23	2

<sup>1</sup> Appears when DST (Daylight Saving Time) Use/Not is set to **On**.

#### Month, Day order, Day of the week, Hour of the day

Set the date and time when daylight saving time ends. The settings here are the same as those for Start time.

#### Explanation

##### Operation of Gradually Correcting the Internal Clock

If the time deviation between the time of the GX/GP internal clock and the correct time (the specified time) is within a specified value, the GX/GP clock is adjusted gradually at a rate of 1 ms per second. The maximum value of time deviation (tm in the figure below) can be selected in the range of 5 s to 15 s.

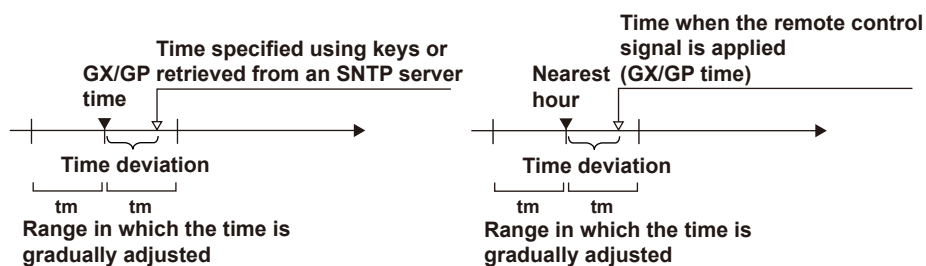

Example: When changing the time to 12 hours 55 minutes 35 seconds when the internal clock is 12 hours 55 minutes 32 seconds  
 The time deviation of 3 seconds is adjusted 1 ms per second. The internal clock will be synchronized to the specified time 50 minutes later.

### 1.23.5 Setting Internal Switches

**Path**

GX/GP: **MENU** key > **Browse** tab > **Setting** > Setting menu **System settings** > **Internal switch settings**

Web application: **Config.** tab > **System settings** > **Internal switch settings**

Hardware configurator: **System settings** > **Internal switch settings**

**Description**

Setup Item	Selectable Range or Options	Default Value
First number	1 to 100	1
Last number	1 to 100	1

**First number**

Select the first internal switch number that you want to set.

**Last number**

Select the last internal switch number that you want to set.

**Internal switch**

Setup Item	Selectable Range or Options	Default Value
Type	Alarm, Manual	Alarm
And/Or <sup>1</sup>	AND, OR	OR

<sup>1</sup> Appears when the type is not set to **Alarm**.

**Type**

Set the item to assign to the internal switch.

Options	Description
Alarm	Assigns the internal switch as an alarm output destination.
Manual	Specify this to manually operate with the "OCmdRelay" communication command.

**And/Or**

Set the internal switch operation conditions when multiple alarm outputs are assigned to the switch.

When the channel 1 alarm output and channel 2 alarm output are assigned, And and Or operations are as shown in the figure below.

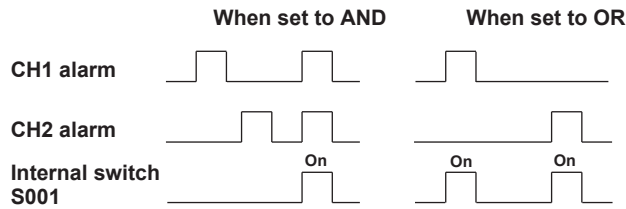

**Preset action**

Setup Item	Selectable Range or Options	Default Value
At power-on	Last value, Off (0), On (1)	Off (0)

**At power-on**

Set the value to replace the internal switch value at power-on.

Options	Description
Previous value	The internal switch state retains the previous value at power-on.
Off (0)	The internal switch state is set to Off (0) at power-on.
On (1)	The internal switch state is set to On (1) at power-on.

\* The action at power-on can be set when the internal switch type is set to Manual.

## 1.23.6 Setting the FAIL Relay and Instrument Information Output (/FL option)

### Path

GX/GP: **MENU** key > **Browse** tab > **Setting** > Setting menu **System settings** > **Status relay**

Web application: **Config.** tab > **System settings** > **Status relay**

Hardware configurator: **System settings** > **Status relay**

### Description

Setup Item	Selectable Range or Options	Default Value
Fail relay	Fail, Status	Fail
Memory/Media status <sup>1</sup>	Off, On	Off
Measurement error <sup>1</sup>	Off, On	Off
Communication error <sup>1</sup>	Off, On	Off
Record stop <sup>1</sup>	Off, On	Off
Alarm <sup>1</sup>	Off, On	Off

<sup>1</sup> Appears when Fail relay is set to **Status**.

### Fail relay

Set whether to output CPU errors to the relay or the instrument status to the relay.

Options	Description
Fail	Outputs failures.
Status	Outputs instrument information.

### Memory/Media status

Set this to **On** to output the internal memory and SD memory card status to the relay.

### Measurement error

Set this to **On** to output measurement errors to the relay.

### Communication error

Set this to **On** to output communication errors to the relay.

### Record stop

Set this to **On** to output record stop to the relay.

### Alarm

Set this to **On** to output alarms to the relay. Alarms whose indications are hidden (▶f or details, see page 1-35 in section 1.2.2, "Setting Alarms") are not output to the relay. Relay output stops after all alarms are released (if no other relay output conditions are met).

### Explanation

#### FAIL

When a failure occurs in the GX/GP CPU, a relay contact signal (1 signal) is output. The relay is energized when the CPU is normal and is de-energized when a CPU error occurs. Therefore, relay output is carried out also when the power is off (including a power failure). You cannot change this behavior.

#### Relay Operation

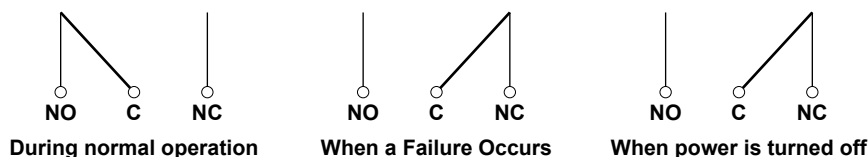

**1.23 Configuring System Settings (Time zone, display language, status relay, etc.)**

**Status Output**

The status below is output with a relay contact signal. You can select whether each status is output to the relay. The relay is energized when the status occurs. You cannot change this behavior.

Status	Description	Corrective Action
Internal memory or SD card status	Error in the internal memory.	Contact your nearest YOKOGAWA dealer for repairs.
	<b>When the auto save function to the SD memory card is On</b>	
	<ul style="list-style-type: none"> <li>The free space on the SD memory card dropped to 10% of the total size (only when the media FIFO (▶ see page 1-143 in section 1.14.2, "Setting the Save Method to Media (Auto save or manual save) and Media FIFO") is disabled).</li> </ul>	Replace the SD memory card.
	<ul style="list-style-type: none"> <li>The status of the internal memory is output when the SD memory card is not inserted or error in the SD memory card.</li> <li>The available space in the internal memory dropped to 25 MB or less.<sup>1</sup></li> <li>The number of files in the internal memory for which Auto Save to the SD memory card has not been completed has exceeded 490 or 980 (GX20-2/GP20-2).</li> </ul>	Insert an SD memory card.
Measurement error	<b>When the auto save function to the SD memory card is Off</b>	
	<ul style="list-style-type: none"> <li>The available space in the internal memory dropped to 25 MB or less.<sup>1</sup></li> <li>The number of files in internal memory for which Manual Save has not been completed has exceeded 490 or 980 (GX20-2/GP20-2).</li> </ul>	Save the data in the internal memory to the SD memory card.
	Error in the A/D converter.	Contact your nearest YOKOGAWA dealer for repairs.
	Burnout has been detected. A burnout can occur when thermocouple or RTD wires are disconnected or when unified signals are outside the specifications.	Check the cause of the burnout.
Communication error	Module error has been detected.	On the system information screen, check whether the module is connected correctly and whether it is being recognized properly.
	A Modbus master, Modbus client, WT communication, SLMP communication error has occurred.	Check the error in the Modbus master, Modbus client, WT client, or SLMP client screen and carry out the corrective action.
Record stop	Recording has stopped.	Start recording.
Alarm occurrence	An alarm has occurred.	Check the alarm.

1 The internal memory's "available space" refers to the following quantities.

- Unused areas
- Areas of data for which Auto Save or Manual Save (▶ see page 1-143 in section 1.14.2, "Setting the Save Method to Media (Auto save or manual save) and Media FIFO") has been completed.

**Relay Operation**

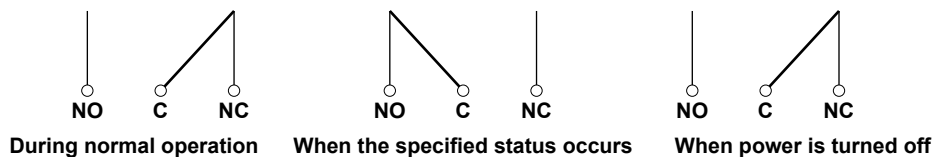

## 1.23.7 Setting the Printer Output Conditions

### Path

GX/GP: **MENU** key > **Browse** tab > **Setting** > Setting menu **System settings** > **Printer settings**

Web application: **Config.** tab > **System settings** > **Printer settings**

Hardware configurator: **System settings** > **Printer settings**

Setup Item	Selectable Range or Options	Default Value
IP Address	0.0.0.0 to 255.255.255.255	0.0.0.0
Paper size	A4, A3, Letter	A4
Page orientation	Vertical, Horizontal	Vertical
Resolution (dpi)	300dpi, 600dpi	300dpi
Number of copies	1 to 10	1
Snapshot	Off, On	Off
Paper size indicator <sup>1</sup>	Off, On	Off

<sup>1</sup> Appears when Snapshot is set to On.

### IP address

Set the IP address of the printer.

### Paper size

Set the size of the paper to print.

### Page orientation

Set the print orientation.

### Resolution (dpi)

Set the print resolution.

### Number of copies

Set the number of copies to print.

### Snapshot

Set this to **On** to print a snapshot.

### Paper size indicator (Release number 2 and later)

Set this to **On** to fit (expand) snapshots to the paper size for printing. If set to **Off**, snapshots are printed at their original size.

### Note

If an SD memory card is not inserted, snapshot printing and report printing using report templates are not possible.

Compatible printers

Printers supporting the HP PCL5c language and can print through port 9100 on a LAN connection

### 1.23.8 Configuring the Sound (Touch sound and warning sound) and LED Settings

#### Path

GX/GP: **MENU** key > **Browse** tab > **Setting** > Setting menu **System settings** > **Sound, LED**

Web application: **Config.** tab > **System settings** > **Sound, LED**

Hardware configurator: **System settings** > **Sound, LED**

#### Description

##### Sound

Setup Item	Selectable Range or Options	Default Value
Touch	Off, On	On
Warning	Off, On	Off

##### Touch

Set this to **On** to play touch operation sounds.

##### Warning

Set this to **On** to play a warning sound when an alarm occurs.

##### LED

Setup Item	Selectable Range or Options	Default Value
MENU key LED	Off, Alarm	Off

##### MENU key LED

Set the MENU key LED operation mode.

Set this to **Alarm** to display alarm status.

Options	Description
Off	Lights in blue. Power-on state.
Alarm	Indicates alarm status with colors.
	<b>LED color and status</b> <b>Status</b>
	Lit in blue                      No alarms; all alarms acknowledged
	Blinking in blue                No alarms; unacknowledged alarms present
	Lit in red                         At least one alarm; all alarms acknowledged
	Blinking in red                 At least one alarm; unacknowledged alarms present

### 1.23.9 Setting Instrument Tags

#### Path

GX/GP: **MENU** key > **Browse** tab > **Setting** > Setting menu **System settings** > **Instruments tag**

Web application: **Config.** tab > **System settings** > **Instruments tag**

Hardware configurator: **System settings** > **Instruments tag**

#### Description

Setup Item	Selectable Range or Options	Default Value
Instruments Tag	Character string (up to 32 characters, <b>Aa#1</b> )	—
Instruments tag No.	Character string (up to 16 characters, <b>Aa#1</b> )	—

##### Instruments Tag

Set the GX/GP instrument tag.

##### Instruments tag No.

Set the GX/GP instrument tag number.

## 1.23.10 Setting Comments to Setting Files

### Path

GX/GP: **MENU** key > **Browse** tab > **Setting** > Setting menu **System settings** > **Setting file**  
 Web application: **Config.** tab > **System settings** > **Setting file**  
 Hardware configurator: **System settings** > **Setting file**

### Description

Setup Item	Selectable Range or Options	Default Value
Setting file comment	Character string (up to 50 characters, <input type="text" value="Aa#1"/> )	—

#### Setting file comment

Set the comment to attach to the setting parameter file.

#### Configuration changes comment (for the advanced security function (/AS option))

Setup Item	Selectable Range or Options	Default Value
Input comment	Off, On	Off

#### Input comment

Set this to **On** to enter comments in setting files when settings are changed. Configuration change comments are also recorded to the event log (comments that only include spaces are not allowed). (Release number 4 (Version 4.07) and later)  
 You can enter configuration change comments when recording is in progress. (Release number 4 (Version 4.07) and later)

### Procedure

- 1** Tap **Comment**, and set the comment.
- 2** Tap **OK**.  
The comment is set in Setting file comment.
- 3** Tap **Close** to return to the original screen.

Operation complete

### 1.23.11 Setting USB Input Devices (/UH option)

#### Path

GX/GP: **MENU** key > **Browse** tab > **Setting** > Setting menu **System settings** > **USB input device**

Web application: **Config.** tab > **System settings** > **USB input device**

Hardware configurator: **System settings** > **USB input device**

#### Description

Setup Item	Selectable Range or Options	Default Value
USB input device	Japanese keyboard (109), US keyboard(104), barcode reader	US keyboard(104)

#### USB input device

Set the type of keyboard to connect to the USB port.

If you are connecting a USB bar code reader, select the type that matches the specifications of your bar code reader.

If you specify **Bar-code reader**, you will be able to execute communication commands from the barcode reader. If you connect a keyboard, you can execute what you enter as communication commands.

#### Executing Communication Commands with a USB Bar code Reader (Release number 2 and later)

##### Executable Commands

Group	Command	Description
Output	FData	Outputs the most recent channel data
	FRelay	Outputs the most recent relay (DO channel) and internal switch status
	Fstar	Outputs the GX/GP status
	FCtrlData	Outputs control data
	FCtrlMode	Outputs the control mode
	FCtrlNo	Outputs the SP number and PID number
	FPrgEnd	Outputs the program control end signal status
	FPrgEvent	Outputs PV event and time event information
	FPrgMode	Outputs the program operation mode
	FPrgPtnCur	Outputs the currently running program pattern number and status output
	FPrgPtnInfo	Outputs the program pattern information
Control	ORec	Starts or stops recording
	OAlarmAck	Clears alarm output (Alarm ACK)
	OExecRec	Manual trigger, manual sample, snapshot, timeout
	OExecSNTP	Queries the time using SNTP
	OMessage	Write messages
	OMath	Starts, stops, resets math or clears the computation dropout status display
	OSaveConf	Saves setting data
	OCommCh	Sets a value to a communication channel
	OEMail	Starts or stops the e-mail transmission function
	OMBRestore	Recovers Modbus manually
	ORTRreset	Resets a relative timer
	OMTRreset	Reset a match time timer
	OCmdRelay	Outputs the DO channel and internal switch status
	OBatName	Sets a batch name
	OBatComment	Sets a batch comment
	OBatText	Sets a batch text
	ODispRate	Switches the trend interval
	OLoadConf	Loads setting data
	OInit	Clears measured data and initializes setting data
	OUserLockACK	User Locked ACK (for the advanced security function (/AS option))
	OLoginAssist	Assists login

Continued on next page



### 1.23 Configuring System Settings (Time zone, display language, status relay, etc.)

Group	Command	Description
Control	OSendValue	Assists character input
	OTransChAO	Individually controls the retransmission output
	OTransAllAO	Collectively controls the retransmission output
	OCmdAO	Sets the manual output
	OSLMPRestore	Manually restores SLMP
	OSaveConfAll	Saves setting data at once
	OLoadConfAll	Loads setting data at once
	OctrlLoadPat	Loads a pattern file
	OctrlSavePat	Saves a pattern file
	OctrlLoadPatAll	Collectively loads pattern files
	OctrlSavePatAll	Collectively saves pattern files
	OCtrlAM	Switches auto/manual/cascade operation
	OCtrlSR	Switches operation run/stop
	OCtrlRL	Switches remote/local
	OCtrlAT	Auto-tuning request
	OCtrlSPN	Selects the target setpoint number
	OCtrlMO	Sets the manual output setpoint
	OCtrlPAT	Switches the pattern number
	OCtrlMODE	Program operation
	OCtrlHOLD	Hold operation
	OCtrlADV	Advance program operation
	OCtrlSP	Sets the target setpoint
	OCtrlTSP	Sets the final target setpoint
	OCtrlRTIME	Sets the segment remaining time
	OCtrlStSeg	Sets the start segment number
	OCtrlDlyTime	Sets the starting time of program operation
	OConfCmt	Write configuration change comment (/AS option)

## 1.23 Configuring System Settings (Time zone, display language, status relay, etc.)

### Terminators

The following input is considered a terminator. The barcode entered up to the terminator is executed as a communication command.

Terminator	Notes
ENTER key	You cannot create a barcode for the ENTER key. Set it as a footer or suffix on the USB barcode reader.
Barcode "/////"	—

### Input Conditions

- The codes that can be input are uppercase and lowercase alphabet characters, numbers, symbols, spaces, and returns.
- The barcode character type that the GX/GP can read is ASCII characters (numbers, symbols, and uppercase and lowercase alphabet characters).
- The longest barcode that can be input is 200 characters excluding the terminator.
- If an invalid character is input, it is not executed.
- Passwords (input displayed with asterisks) cannot be set or input.

### Commands That Can Be Executed Depending on Touch-Operation Security Settings

Depending on the touch-operation security settings and login status, the following communication commands can be executed.

Group	Command	No Security	With Security	
			No Logged-in User	With Logged-in User
Output	FData	✓	✓	✓
	FRelay	✓	✓	✓
	Fstar	✓	✓	✓
	FCtrlata	✓	✓	✓
	FCtrlMode	✓	✓	✓
	FCtrlNo	✓	✓	✓
	FPrgEnd	✓	✓	✓
	FPrgEvent	✓	✓	✓
	FPrgMode	✓	✓	✓
	FPrgPtnCur	✓	✓	✓
	FPrgPtnInfo	✓	1	✓
Control	Orec	✓	1	✓
	OAlarmAck	✓	1	✓
	OExecRec	✓	1	✓
	OExecSNTP	✓	1	✓
	OMessage	✓	1	✓
	OMath	✓	1	✓
	OSaveConf	✓	1	✓
	OCommCh	✓	✓	✓
	OEMail	✓	1	✓
	OMBRestore	✓	1	✓
	ORTReset	✓	1	✓
	OMTRReset	✓	1	✓
	OCmdRelay	✓	1	✓
	OBatName	✓	1	✓
	OBatComment	✓	1	✓
	OBatText	✓	1	✓
	ODispRate	✓	1	✓
	OLoadConf	✓	1	✓
	OInit	✓	1	✓
	OUserLockACK	✓	1	✓
	OLoginAssist	2	✓	3
	OSendValue	✓	✓	✓
	OTransChAO	✓	1	✓
	OTransAllAO	✓	1	✓
	OCmdAO	✓	1	✓
	OSLMPRestore	✓	1	✓
	OSaveConfAll	✓	1	✓
	OLoadConfAll	✓	1	✓

Continued on next page

### 1.23 Configuring System Settings (Time zone, display language, status relay, etc.)

Group	Command	No Security	With Security	
			No Logged-in User	With Logged-in User
Control	OctrlLoadPat	✓	1	✓
	OctrlSavePat	✓	1	✓
	OctrlLoadPatAll	✓	1	✓
	OctrlSavePatAll	✓	1	✓
	OctrlIAM	✓	1	✓
	OctrlSR	✓	1	✓
	OctrlIRL	✓	1	✓
	OctrlIAT	✓	1	✓
	OctrlSPN	✓	1	✓
	OctrlIMO	✓	1	✓
	OctrlPAT	✓	1	✓
	OctrlMODE	✓	1	✓
	OctrlHOLD	✓	1	✓
	OctrlADV	✓	1	✓
	OctrlSP	✓	1	✓
	OctrlTSP	✓	1	✓
	OctrlRTIME	✓	1	✓
	OctrlStSeg	✓	1	✓
	OctrlDlyTime	✓	1	✓
	OConfCmt	✓	1	✓

- 1 Will result in communication error and display error
- 2 Will result in a negative response (E0) but no display error
- 3 Will result in a negative response (E0) and display error

## 1.24 Configuring the Security Functions

Set the security function. The operation lock function prohibits touch screen operation (including the operation through the START/STOP key). To clear the operation lock, enter the password.

The login function allows only registered users to use the GX/GP. Access from communication functions can also be limited to users registered here.

Authority of user can be configured to restrict the items that each user is allowed to use. (Up to 10 conditions can be set.)

If you are using the advanced security function (/AS option), see the Advanced Security Function User's Manual (IM 04L51B01-05EN).

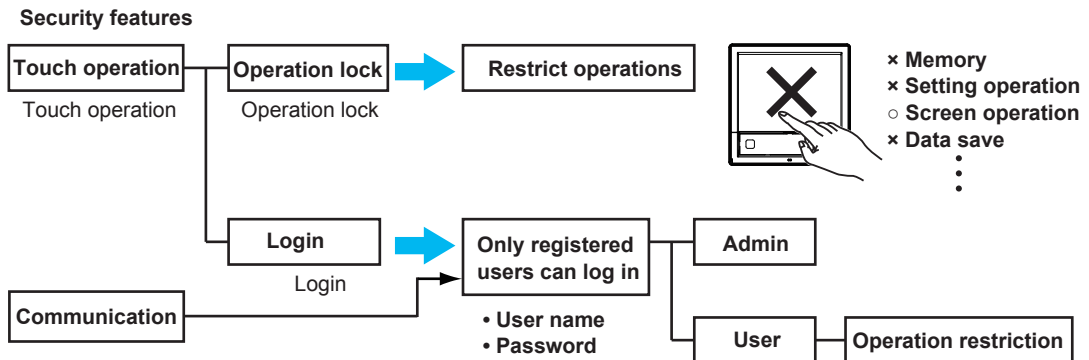

### 1.24.1 Configuring the Security Functions

#### Path

GX/GP: **MENU** key > **Browse** tab > **Setting** > Setting menu **Security settings** > **Basic settings**

Web application: **Config.** tab > **Security settings** > **Security basic settings**

Hardware configurator: **Setting** tab > **Security settings** > **Security basic settings**

#### Description

#### Security function

Setup Item	Selectable Range or Options	Default Value
Touch operation	Off, Login, Operation Lock <sup>1</sup>	Off
Communication	Off, Login	Off

<sup>1</sup> Does not appear for the advanced security function.

#### Touch operation

Set the type of touch screen security to apply.

Options	Description
Off	Disables the security function.
Login	Enables the login function.
Operation lock	Enables the function that prohibits touch screen operation (including the operation through the START/STOP key)

#### Communication

To apply communication access security, set this to **Login**.

Options	Description
Off	Disables the security function.
Login	Allows only registered users to access the GX/GP via communication.

**Note**

- If Touch operation is set to **Login**, configure “User settings” and “Authority of user” and then save the settings. If you save immediately after setting **Login**, you will exit from the setup menu and be logged out. You must log in to configure “User settings” and “Authority of user.”
- In Chrome, turn on “Allow Chrome sign-in,” and then clear the cache. If you do not clear the cache, the browser will clear the user name and password you are trying to enter in the user authentication dialog box before you can finish typing.

**Logout<sup>1</sup> (touch operation item)**

Setup Item	Selectable Range or Options	Default Value
Auto logout	Off, 1min, 2min, 5min, 10min	Off
Operation without Login	Off, On	Off

<sup>1</sup> Appears when touch operation is set to **Login**.

**Auto logout**

Options	Description
Off	Stays logged in until the user logs out.
1min to 10min	When you log in through touch operation, you will be automatically logged out when there is no activity for the specified duration.

**Operation without Login**

Set the operations that users can carry out without being logged in.

Options	Description
Off	Allows only login operation.
On	Allows login operation and switching the operation screen.

**Explanation****Login and Logout**

Log in by entering the user name and password in the following situations.

GX/GP Access	Login Necessary
Touch operation	<ul style="list-style-type: none"> <li>• When the power is turned on</li> <li>• When you log out and log in again</li> </ul>
Communication	When accessing general purpose communication, FTP server, or Web server

**1.24.2 Setting Items to Lock the Operation Of (When touch operation is set to operation lock)**

This is not available when you are using the advanced security function (/AS option).

**Path**

GX/GP: **MENU** key > **Browse** tab > **Setting** > Setting menu **Security settings** > **Operation Lock<sup>1</sup>**

Web application: **Config.** tab > **Security settings** > **Operation Lock<sup>1</sup>**

Hardware configurator: **Setting** tab > **Security settings** > **Operation Lock<sup>1</sup>**

- <sup>1</sup> Appears when the touch operation of the security function is set to **Operation Lock**. Does not appear for the advanced security function.

**Description****Operation Lock function**

Setup Item	Selectable Range or Options	Default Value
Password	Character string (up to 20 characters, <b>Aa#1</b> )	—

**Password**

Sets the password that is used to release the operation lock.

The password<sup>1</sup> is displayed as “\*\*\*\*\*.”

- <sup>1</sup> No default password is set.

## 1.24 Configuring the Security Functions

### Limitations

These are shared with the user restriction items described in "page 1-225 in section 1.24.4, "Setting User Restrictions (When touch operation or communication is set to login)".

For details on controls, see the *Loop Control Function, Program Control Function (PG Option) User's Manual* (IM 04L51B01-31EN).

Setup Item	Selectable Range or Options	Default Value
Record	Free, Lock	Free
Math	Free, Lock	Free
Data save	Free, Lock	Free
Message	Free, Lock	Free
Batch	Free, Lock	Free
AlarmACK	Free, Lock	Free
Communication	Free, Lock	Free
Touch operation	Free, Lock	Free
Time set	Free, Lock	Free
Setting operation	Free, Lock	Free
External media	Free, Lock	Free
System operation <sup>1</sup>	Free, Lock	Free
Output operation <sup>1</sup>	Free, Lock	Free

<sup>1</sup> Release number 2 and later.

### Record

Set this to **Lock** to restrict record start/stop operation.

This also applies to the corresponding operation using START/STOP key.

### Math

Set this to **Lock** to restrict the math operations below.

This also applies to the corresponding operation using START/STOP key.

#### Operation

Start computation  
Stop computation  
Reset computation

### Data save

Set this to **Lock** to restrict the data save operations below.

#### Operation

Save display data  
Save event data  
Event trigger  
Manual sample  
Snap shot  
Reset timer  
Reset match time timer

### Message

Set this to **Lock** to restrict message writing operation.

### Batch

Set this to **Lock** to restrict the batch operations below.

#### Operation

Write batch numbers  
Write lot numbers  
Write comments  
Write in text fields

**AlarmACK**

Set this to **Lock** to restrict alarm ACK operation.

**Touch operation**

Set this to **Lock** to restrict the touch operations below.

**Operation**

Register the standard display

Register favorites

Switch screen content

Switch the display rate

**Communication**

Set this to **Lock** to restrict the following operations: start, stop, and test mail; test FTP, get and release network information; KDC test operation (/AS option); manually restore SLMP (/E4 option); test printer output; test KDC; manually recover Modbus master; and manually recover Modbus client

**Time set**

Set this to **Lock** to restrict manual SNTP server time adjustment and date/time adjustment.

**Setting operation**

Set this to **Lock** to restrict setting operation.

**External media**

Set this to **Lock** to restrict the following operations: save, load, and list files; manually save data; save data at insertion; save alarms; abort saving; create certificate requests; install certificates; and install intermediate certificates.

**System Operation (Release number 2 and later)**

Set this to **Lock** to restrict the following operations: initialize; reconfigure system; manage, display, and delete certificates; and execute unverified certificates.

**Output Operation (Release number 2 and later)**

Set this to **Lock** to restrict internal switch operations, relay operations, communication channel operations, and AO channel operations (retransmission output, manual output).

### 1.24.3 Setting Registered User Conditions (When touch operation or communication is set to login)

**Path**

GX/GP: **MENU** key > **Browse** tab > **Setting** > Setting menu **Security settings** > **User settings**<sup>1</sup>

Web application: **Config.** tab > **Security settings** > **User settings**<sup>1</sup>

Hardware configurator: **Setting** tab > **Security settings** > **User settings**<sup>1</sup>

<sup>1</sup> Appears when **Touch operation** or **Communication** of the security function is set to **Login**

**Description**

Setup Item	Selectable Range or Options	Default Value
User number	1 to 50 <sup>1</sup>	1

<sup>1</sup> 1 to 100 (GX10/GP10/GX20-1/GP20-1), 1 to 200 (GX20-2/GP20-2) for the advanced security function (/AS option).

**User number**

Select the user number to register.

**User settings**

Setup Item	Selectable Range or Options	Default Value
User level	Off, Admin, User	—
Mode	Touch operation, Communication, Touch operation + Communication	Touch operation + Communication
User name	Character string <sup>3</sup> (up to 20 characters, <b>A a # 1</b> )	—
Initialize password	Back, Initialize password	—
Authority of user <sup>1</sup>	Off, On	Off
Authority number <sup>2</sup>	Authority number 1 to 10	1

<sup>1</sup> Appears when the user level is set to **User**.

<sup>2</sup> Appears when Authority of user is set to **On**.

<sup>3</sup> NULL is not allowed.

**User level**

Set the user level. System administrators (Admin) are users that can perform all operations on the GX/GP. When using the login function, at least one user must be registered as a system administrator. The user level of User number 1 is fixed to **Admin**.

**Mode**

Options	Description
Touch operation	You can log in to the GX/GP through touch operation.
Communication <sup>1</sup>	You can log in to the GX/GP via communication.
Touch operation + Communication	You can log in to the GX/GP through touch operation and communication.

<sup>1</sup> **Communication** cannot be specified for user number 1.

**User name**

Set the user name. Duplicate user names are not allowed.

User names cannot contain spaces.

**Initialize password**

Select **Initialize password** to initialize a password. To cancel the initialization, select **Back**.

**Authority of user**

When the user level is **User**, set this to **On** to apply user restrictions.

**Authority number**

When Authority of user is set to **On**, set the authority number.

For details on setting user restrictions, see the next section.



**Note**

The default user name for user number 1 is "User01".

The default password is "default."

To change the password, log in and perform **Password change**.

Even if you want to set only communication to **Login**, set Touch operation to Login once and set a password.

► For the procedure, see page 2-89 in section 2.10.2, "Changing the Password".

## 1.24.4 Setting User Restrictions (When touch operation or communication is set to login)

**Path**

GX/GP: **MENU** key > **Browse** tab > **Setting** > Setting menu **Security settings** > **Authority of user**

Web application: **Config.** tab > **Security settings** > **Authority of use**

Hardware configurator: **Setting** tab > **Security settings** > **Authority of user**

**Description**

Setup Item	Selectable Range or Options	Default Value
Authority number	1 to 10	1

**Authority number**

Select the user number to apply user restrictions.

**Authority of user**

► For the user restriction items, see page 1-221 in section 1.24.2, "Setting Items to Lock the Operation Of (When touch operation is set to operation lock)".

## 1.25 Loading Settings

Load and delete setting parameters, report templates, trusted certificates, custom displays (/CG option), program patterns (/PG option) (release number 4 and later), and scale images.

### 1.25.1 Loading Setting Parameters

#### Path

GX/GP: **MENU** key > **Browse** tab > **Save load** > Menu **Load settings** > **Setting parameters**

Web application: **Data** tab > **Save/Load** > **Setting parameters**

#### Description

Setup Item	Selectable Range or Options	Default Value
Media kind	SD, USB	1
Select file	—	—

1 Default value of Media kind

Media status	Default Value
Non	Media is not recognized
SD memory card	SD
SD memory card, USB flash memory (/UH option)	SD
USB meory (/UH option)	USB

#### Media kind

Set the type of media.

#### Select file

Set the setting parameter file to load.

Setup Item	Selectable Range or Options	Default Value
All settings	Off, On	On

#### All settings

Set this to **On** to load all settings. Set this to **Off** to load security, control settings, IP address, and other settings separately.

Setup Item	Selectable Range or Options	Default Value
Security <sup>1</sup>	Off, On	On
Control settings <sup>3</sup>	Off, On	On
IP address <sup>1</sup>	Off, On	On
Other <sup>1</sup>	Off, On	On
Communication(Server settings) <sup>2</sup>	Off, On	On
Calibration correction settings <sup>2</sup>	Off, On	On
Instruments tags, etc. <sup>2</sup>	Off, On	On

1 Appears when All settings is set to **Off**.

2 Appears when Other is set to **On**. Release number 3 and later.

3 Appears when a PID control module is detected. Release number 4 and later.

#### Security

Set this to **On** to load only the security settings.

**Note**

If the advanced security function (/AS option) is in use, passwords are not loaded except for monitor users. All administrator, second administrator and user passwords are set to their defaults.

▶ See "Reusing Setting Parameters" section 1.3.3, "User Levels," in the Advanced Security Function (/AS) User's Manual (IM 04L51B01-05EN).

**Control settings**

Set this to **On** to load control settings.

Setup items that are loaded

- Control settings
- Program pattern settings
- Control event action

**IP address**

Set this to **On** to load only the IP address, DHCP, and DNS settings.

**Other**

Set this to **On** to load settings other than security, IP address, and control settings.

**Communication (Server settings)**

Set this to **On** when you want to load the server list settings, server encryption settings, and channel conversion setting of DARWIN compatible communication.

**Calibration correction settings**

Set this to **On** to load calibration correction settings and calibration reminder settings (/AH).

**Instruments tags, etc.**

Set this to **On** to load instrument tag settings.

**Procedure****Loading All Stings**

- 1** Tap **Media kind**, set the medium.
- 2** Tap **Select file**, set the file.
- 3** Tap **All settings**, set to **On**.
- 4** Tap **Execute**.  
The setting parameters that you specified are loaded.
- 5** Tap **Exit**.  
The GX/GP returns to the original screen.

Operation complete

**Loading Specific Items**

- 1** Tap **Media kind**, set the medium.
- 2** Tap **Select file**, set the file.
- 3** Tap **All settings**, set to **Off**.
- 4** Set the items that you want to load to **On**.
- 5** Tap **Execute**.  
The setting parameters that you specified are loaded.
- 6** Tap **Exit**.  
The GX/GP returns to the original screen.

Operation complete

**Note**

When the language setting is changed, the GX/GP may restart.

**Explanation**

**Setting Parameter Files**

- The extension is .GNL.  
When the advanced security function (/AS option) is in use, the extension is .GSL.
- The following settings are also saved.
  - Current monitor display conditions
  - Standard display registration data
  - Favorite screen registration data

**Loading Setting Parameters**

- The monitor display conditions, registered standard display, and registered favorite screens are also loaded.
- If the loaded setting parameters are not applied, check the error log (▶ see page 2-53 in section 2.3.5, “Displaying Logs”).

**1.25.2 Loading and Deleting Scale Images**

**Loading**

**Path**

GX/GP: **MENU** key > **Browse** tab > **Save load** > Menu **Load settings** > **Scale image** > **Load scale image**

**Description**

Setup Item	Selectable Range or Options	Default Value
Media kind	SD, USB	1
Select file	—	—

<sup>1</sup> See page 1-226 in section 1.25.1, “Loading Setting Parameters”.

**Media kind**

Set the type of media.

**Select file**

Set the scale image to load.

Setup Item	Selectable Range or Options	Default Value
Batch group number <sup>1</sup>	GX10/GP10/GX20-1/GP20-1: 1 to 6 GX20-2/GP20-2: 1 to 12	1
Group number	GX20-1/GP20-1: 1 to 50 GX20-2/GP20-2: 1 to 60 GX10/GP10: 1 to 30	1
Data	—	—

<sup>1</sup> Appears when the multi-batch function (/BT option) is enabled.

**Batch group number**

Set the batch group number to load the scale image to.

**Group number**

Set the group number to load the scale image to.

**Data**

Displays the presence or absence of the specified file.

**Procedure****When the multi-batch function (/BT option) is not available or disabled**

- 1** Tap **Media kind**, set the medium.
- 2** Tap **Select file**, set the file.
- 3** Tap **Group number**, set the group number to load the scale image to.
- 4** Tap **Execute**.  
The scale image is loaded to the specified group.
- 5** Tap **Exit**.  
The GX/GP returns to the original screen.

Operation complete**When the multi-batch function (/BT option) is enabled**

- 1** Tap **Media kind**, set the medium.
- 2** Tap **Select file**, set the file.
- 3** Tap **Batch group number** to set the batch group number to load the scale image to.
- 4** Tap **Group number**, set the group number to load the scale image to.
- 5** Tap **Execute**.  
The scale image is loaded to the specified group.
- 6** Tap **Exit**.  
The GX/GP returns to the original screen.

Operation complete

In **Display settings**, under **Group settings**, **Scale image** must be set to **On**.

▶ See page 1-111 in section 1.10.2, "Setting Display Groups"

**Deleting****Path**

GX/GP: **MENU** key > **Browse** tab > **Save load** > Menu **Load settings** > **Scale image** > **Delete scale image**

**Description**

Setup Item	Selectable Range or Options	Default Value
Batch group number <sup>1</sup>	GX10/GP10/GX20-1/GP20-1: 1 to 6 GX20-2/GP20-2: 1 to 12	1
Group number	GX20-1/GP20-1: 1 to 50 GX20-2/GP20-2: 1 to 60 GX10/GP10: 1 to 30	1
Data	—	—

<sup>1</sup> Appears when the multi-batch function (/BT option) is enabled.

**Batch group number**

Set the batch group number to delete the scale image from.

**Group number**

Set the group number to delete the scale image from.

**Data**

Displays the presence or absence of the specified file.

**Procedure**

**When the multi-batch function (/BT option) is not available or disabled**

- 1** Tap **Group number** to set the group number to delete the scale image from.
- 2** Tap **Execute**.  
If a message appears for confirming, tap **OK**.  
The scale image is deleted from the specified group.
- 3** Tap **Exit**.  
The GX/GP returns to the original screen.

Operation complete

**When the multi-batch function (/BT option) is enabled**

- 1** Set the batch group number to delete the scale image from.
- 2** Set the group number to delete the scale image from.
- 3** Tap **Execute**.  
If a message appears for confirming, tap **OK**.  
The scale image is deleted from the specified group.
- 4** Tap **Exit**.  
The GX/GP returns to the original screen.

Operation complete

**1.25.3 Loading Report Templates (/MT option)**

**Path**

GX/GP: **MENU** key > **Browse** tab > **Save load** > Menu **Load settings** > **Report template**  
 Web application: **Data** tab > **Save/Load** > **Report template**

**Description**

Setup Item	Selectable Range or Options	Default Value
Media kind	SD, USB	1
File type	Excel file, PDF/Printer file	Excel file
Select file	—	—

1 See page 1-226 in section 1.25.1, "Loading Setting Parameters".

**Media kind**

Set the type of media.

**File type**

Set the file type.

**Select file**

Set the file to load.

Setup Item	Selectable Range or Options	Default Value
Report kind	Hourly, Daily, Weekly, Monthly, Hourly + Daily, Daily + Weekly, Daily + Monthly, Batch, Daily custom	Hourly
Data	—	—

**Report kind**

Set the kind of report template.

**Data**

Displays the presence or absence of the specified file.

**Procedure****Loading a Report Template File**

- 1** Tap **Media kind**, set the medium.
- 2** Tap **Select file**, set the file.
- 3** Tap **Select file**, select the file to load, and tap **OK**.
- 4** Tap **Report kind** and then the kind of report template to load.
- 5** Tap **Execute**.  
The report template is loaded.
- 6** Tap **Exit**.  
The GX/GP returns to the original screen.

[Operation complete](#)

### 1.25.4 Loading and Deleting Trusted Certificates (Release number 2 and later)

To use this function, you must set **Encryption function** to **On** under **Encryption/Certificate** of **Init/Calib**.

#### Loading a Certificate

##### Path

GX/GP: **MENU** key > **Browse** tab > **Save load** > Menu **Load settings** > **Trusted Certificate** > **Load trusted certificate**

##### Description

Setup Item	Selectable Range or Options	Default Value
Media type	SD, USB	1
Select file	—	—

1 See page 1-226 in section 1.25.1, "Loading Setting Parameters".

#### Certificate Information

Setup Item	Selectable Range or Options	Default Value
Issuer	—	—
Subject	—	—
Valid not before	—	—
Validity not after	—	—
Front half of hash value (SHA1)	—	—
Latter half of hash value (SHA1)	—	—

#### Issuer, Subject, Valid Not Before, Valid Not Before, Front Half of Hash Value (SHA1), Latter Half of Hash Value (SHA1)

The items in the file to be loaded are displayed.

► For details, see page 1-264 in section 1.30.4, "Viewing Certificate Details and Removing Certificates".

##### Procedure

- 1** Tap **Media type** to select the medium.
- 2** Tap **Select file** to set the file to be loaded.  
Certificate Information shows the items in the certificate.
- 3** Tap **Execute**.  
The certificate is loaded.
- 4** Tap **Exit**.  
The GX/GP returns to the original screen.

Operation complete

#### Deleting a Certificate

##### Path

GX/GP: **MENU** key > **Browse** tab > **Save load** > Menu **Load settings** > **Trusted Certificate** > **Deleting trusted certificate**

##### Description

Setup Item	Selectable Range or Options	Default Value
Select file	—	—

#### Select File

Set the file you want to delete.



## Certificate Information

Setup Item	Selectable Range or Options	Default Value
Issuer	—	—
Subject	—	—
Valid not before	—	—
Validity not after	—	—
Front half of hash value (SHA1)	—	—
Latter half of hash value (SHA1)	—	—

### Issuer, Subject, Valid Not Before, Valid Not Before, Front Half of Hash Value (SHA1), Latter Half of Hash Value (SHA1)

The items in the certificate to be deleted are displayed.

- ▶ For details, see page 1-264 in section 1.30.4, “Viewing Certificate Details and Removing Certificates”.

#### Procedure

- 1** Tap **Select file** to set the certificate to be deleted.
- 2** Tap **Execute**.  
A confirmation screen is displayed.
- 3** Tap **OK**.  
The certificate is deleted.
- 4** Tap **Exit**.  
The GX/GP returns to the original screen.

Operation complete

## 1.25.5 Loading and Deleting Custom Displays (/CG option) (Release number 2 and later)

### Loading a Specific Display

#### Path

GX/GP: **MENU** key > **Browse** tab > **Save load** > Menu **Load settings** > **Custom display** > Load custom display screen **Load custom display on specified screen**

#### Description

Setup Item	Selectable Range or Options	Default Value
Media type	SD, USB	1
Select file	—	—
Display Name	—	—
Display No.	1 to 30	1
Data	—	—

<sup>1</sup> See page 1-226 in section 1.25.1, "Loading Setting Parameters".

#### Media Type

Set the type of media.

#### Select File

Set the file.

#### Display Name

Displays the name of the custom display.

#### Display No.

Set the display number to assign the custom display to.

#### Data

Displays the presence or absence of the specified data in the GX/GP.

#### Procedure

- 1** Tap **Media type** to select the medium.
- 2** Tap **Select file** to set the file.
- 3** Tap **Display No.** to set the display number.
- 4** Tap **Execute**.  
The selected custom display is loaded.
- 5** Tap **Exit**.  
The GX/GP returns to the original screen.

Operation complete

## Loading All Displays

### Path

GX/GP: **MENU** key > **Browse** tab > **Save load** > Menu **Load settings** > **Custom display** > Load custom display screen **Load custom display on all screen**

### Description

Setup Item	Selectable Range or Options	Default Value
Media type	SD, USB	1
Select folder	—	—

1 See page 1-226 in section 1.25.1, "Loading Setting Parameters".

### Media Type

Set the media.

### Select Folder

Set the folder.

### Procedure

- 1** Tap **Media type** to select the medium.
- 2** Tap **Select folder** to set the folder.
- 3** Tap **Execute**.  
All custom displays are loaded.
- 4** Tap **Exit**.  
The GX/GP returns to the original screen.

[Operation complete](#)

## Deleting a Specific Display

### Path

GX/GP: **MENU** key > **Browse** tab > **Save load** > Menu **Load settings** > **Custom display** > Delete custom display screen **Delete custom display from specified screen**

### Description

Setup Item	Selectable Range or Options	Default Value
Display No.	1 to 30	1
Data	—	—

### Display No.

Set the number of the custom display to delete.

### Data

Displays the presence or absence of the specified data in the GX/GP.

### Procedure

- 1** Tap **Display No.** to set the number of the custom display to delete.
- 2** Tap **Execute**.  
The custom display is deleted.
- 3** Tap **Exit**.  
The GX/GP returns to the original screen.

[Operation complete](#)

### 1.25.6 Loading and Deleting Program Patterns (/PG option) (Release number 4 and later),

Each program pattern is saved to a separate file.

#### Loading a Specified Pattern

##### Path

GX/GP: **MENU** key > **Browse** tab > **Save load** > Menu **Load settings** > **Program pattern** > Load program pattern **Load specified program pattern**

##### Description

Setup Item	Selectable Range or Options	Default Value
Media Type	SD/USB	1
Select file	—	—
Pattern name	—	—
Pattern number	1 to 99	1
File	—	—

<sup>1</sup> See page 1-226 in section 1.25.1, "Loading Setting Parameters".

#### Media type

Set the media.

#### Select file

Select a file.

#### Pattern name

The name of the selected pattern is displayed.

#### Pattern number

Set the pattern number to be loaded.

#### File

Displays the presence or absence of the specified pattern in the GX/GP.

##### Procedure

- 1** Tap **Media type** to select the medium.
- 2** Tap **Select file** to set the file.
- 3** Tap **Pattern number** to set the pattern number.
- 4** Tap **Execute**.  
The selected pattern is loaded.
- 5** Tap **Close**.  
The GX/GP returns to the original screen.

Operation complete

## Loading All Patterns

### Path

GX/GP: **MENU** key > **Browse** tab > **Save load** > Menu **Load settings** > **Program pattern** > Load program pattern **Load all program patterns**

### Description

Setup Item	Selectable Range or Options	Default Value
Media type	SD/USB	1
Select folder	—	—

<sup>1</sup> See page 1-226 in section 1.25.1, "Loading Setting Parameters".

#### Media type

Set the media.

#### Select folder

Set the folder.

### Procedure

- 1** Tap **Media type** to select the medium.
- 2** Tap **Select folder** to set the folder.
- 3** Tap **Execute**.  
All patterns are loaded.
- 4** Tap **Close**.  
The GX/GP returns to the original screen.

[Operation complete](#)

## Deleting a Specified Pattern

### Path

GX/GP: **MENU** key > **Browse** tab > **Save load** > Menu **Load settings** > **Program pattern** > Load program pattern **Delete specified program pattern**

### Description

Setup Item	Selectable Range or Options	Default Value
Pattern number	1 to 99	1
File	—	—

#### Pattern number

Set the number of the pattern to delete.

#### File

Displays the presence or absence of the specified file in the GX/GP.

### Procedure

- 1** Tap **Pattern number** to set the number of the pattern to be deleted.
- 2** Tap **Execute**.  
The specified pattern is deleted.
- 3** Tap **Close**.  
The GX/GP returns to the original screen.

[Operation complete](#)

**Deleting All Patterns**

**Path**

GX/GP: **MENU** key > **Browse** tab > **Save load** > Menu **Load settings** > **Program pattern** > Load program pattern **Delete all program patterns**

**Description**

Setup Item	Selectable Range or Options	Default Value
Delete all program patterns	—	—

**Delete all program patterns**

Displays the presence or absence of patterns.

**Procedure**

- 1** Tap **Execute**.  
All patterns are deleted.
- 2** Tap **Close**.  
The GX/GP returns to the original screen.

Operation complete

**1.25.7 Loading Setting Parameters, Scale Images, Report Templates, Trusted Certificates (Release number 2 and later), Custom Display (/CG option) (Release number 2 and later), Program Pattern (/PG option) (Release number 4 and later), Multi-batch Settings (/BT option) (Release number 3 and later) at Once**

**Path**

GX/GP: **MENU** key > **Browse** tab > **Save load** > Menu **Load settings** > **All above**

**Description**

Setup Item	Selectable Range or Options	Default Value
Media kind	SD, USB	<sup>1</sup>
Select folder	—	—

<sup>1</sup> See page 1-152 in section 1.20.1, "Loading Setting Parameters"

**Media kind**

Set the type of media.

**Select folder**

Set the folder.

Setup Item	Selectable Range or Options	Default Value
Load multi-batch settings <sup>1</sup>	Off, On	Off

<sup>1</sup> Appears when the multi-batch function (/BT option) is enabled.

**Load multi-batch settings**

Set this to **On** to load multi batch settings.

Load multi-batch settings is fixed to Off when the measurement mode is not Normal.

**Procedure**

- 1** Tap **Media kind**, set the medium.
- 2** Tap **Select folder**, set the folder.
- 3** Tap **Execute**.  
All files are loaded.
- 4** Tap **Exit**.  
The GX/GP returns to the original screen.

**Operation complete**

For the procedure when the multi-batch function (/BT option) is enabled, see section 3.1.14, "Loading Setting Parameters," in the multi-batch function manual (IM 04L51B01-03EN).

**Note**

- The conditions for loading files depend on the contents of setting parameters, scale images, and report templates. Check the contents before loading them.
- When you load multi batch settings, all settings except the log are initialized first. Then all the settings are loaded, and the system is restarted.

## 1.26 Saving Setting Parameters

Save setting parameters, scale images, report templates, trusted certificates, custom displays, and program patterns (/PG option) (release number 4 and later).

### 1.26.1 Saving the Setting Parameters

#### Path

GX/GP: **MENU** key > **Browse** tab > **Save load** > Menu **Save settings** > **Setting parameters**

Web application: **Data** tab > **Save/Load** > **Setting parameters**

#### Description

Setup Item	Selectable Range or Options	Default Value
Media kind	SD, USB	1
File name	Character string (up to 32 characters)	—
Comment	Character string (up to 50 characters)	—

1 See page 1-226 in section 1.25.1, "Loading Setting Parameters".

#### Media kind

Set the save destination medium.

#### File name

Set the file name.

#### Comment

Set this to attach a comment to the file that you are saving.

#### Procedure

- 1 Tap **Media kind**, set the medium.
- 2 Tap **File name**, set the file name.
- 3 Tap **Comment**, set the comment.
- 4 Tap **Execute**.  
The file is saved.
- 5 Tap **Exit**.  
The GX/GP returns to the original screen.

[Operation complete](#)



## 1.26.2 Saving a Scale Image

### Path

GX/GP: **MENU** key > **Browse** tab > **Save load** > Menu **Save settings** > **Scale image**

### Description

Setup Item	Selectable Range or Options	Default Value
Media kind	SD, USB	1
File name	—	—

1 See page 1-226 in section 1.25.1, "Loading Setting Parameters".

#### Media kind

Set the save destination medium.

#### File name

Set the file name.

Setup Item	Selectable Range or Options	Default Value
Batch group number	GX10/GP10/GX20-1/GP20-1: 1 to 6 GX20-2/GP20-2: 1 to 12	1
Group number	GX20-1/GP20-1: 1 to 50 GX20-2/GP20-2: 1 to 60 GX10/GP10: 1 to 30	1
Data	—	—

#### Batch group number

Set the batch group number to save the scale image to.

#### Group number

Set the group number to save the scale image to.

#### Data

Displays the presence or absence of the specified file.

### Procedure

**When the multi-batch function (/BT option) is not available or disabled**

- 1** Tap **Media kind**, set the medium.
- 2** Tap **File name**, set the file name.
- 3** Tap **Group number**, set the group number.
- 4** Tap **Execute**.  
The scale image is saved.
- 5** Tap **Exit**.  
The GX/GP returns to the original screen.

Operation complete

## 1.26 Saving Setting Parameters

---

### When the multi-batch function (/BT option) is enabled

- 1** Tap **Media type** to select the medium.
- 2** Tap **File name**, and set the file name.
- 3** Tap **Batch group number** to set the batch group number.
- 4** Tap **Group number** to set the group number.
- 5** Tap **Execute**.  
The scale image is saved.
- 6** Tap **Exit**.  
The GX/GP returns to the original screen.

Operation complete

### 1.26.3 Saving a Report Template

#### Path

GX/GP: **MENU** key > **Browse** tab > **Save load** > Menu **Save settings** > **Report template**  
 Web application: **Data** tab > **Save/Load** > **Report template**

#### Description

Setup Item	Selectable Range or Options	Default Value
Media kind	SD, USB	1
File type	Excel file, PDF/Printer file	Excel file
File name	—	—

1 See page 1-226 in section 1.25.1, "Loading Setting Parameters".

#### Media kind

Set the save destination medium.

#### File type

Set the type of file to save.

#### File name

Set the file name.

Setup Item	Selectable Range or Options	Default Value
Report kind	Hourly, Daily, Weekly, Monthly, Hourly + Daily, Daily + Weekly, Daily + Monthly, Batch, Daily custom	Hour
Data	—	—

#### Report kind

Set the kind of report template.

#### Data

Displays the presence or absence of the specified file.

#### Procedure

- 1** Tap **Media kind**, set the medium.
- 2** Tap **File type**, set the file type.
- 3** Tap **Report kind** and then the kind of report template to save.
- 4** Tap **Execute**.  
The report template file is saved.
- 5** Tap **Exit**.  
The GX/GP returns to the original screen.

[Operation complete](#)

### 1.26.4 Saving Trusted Certificates (Release number 2 and later)

**Path**

GX/GP: **MENU** key > **Browse** tab > **Save load** > Menu **Save settings** > **Trusted Certificate**

**Description**

Setup Item	Selectable Range or Options	Default Value
Media type	SD, USB	1
Certificate	—	—

1 See page 1-226 in section 1.25.1, "Loading Setting Parameters".

**Media Type**

Set the media type.

**Certificate**

Displays the presence or absence of a certificate.

**Procedure**

- 1** Tap **Media type** to select the medium.
- 2** Tap **Execute**.  
The certificate is saved.
- 3** Tap **Exit**.  
The GX/GP returns to the original screen.

[Operation complete](#)

### 1.26.5 Saving Custom Displays (/CG option) (Release number 2 and later)

**Saving a Specific Display**

**Path**

GX/GP: **MENU** key > **Browse** tab > **Save load** > Menu **Save settings** > **Custom display** > **Save custom display on specified screen**

**Description**

Setup Item	Selectable Range or Options	Default Value
Media type	SD, USB	1
File name	—	—
Display No.	1 to 30	—
Display Name	—	—
Data	—	—

1 See page 1-226 in section 1.25.1, "Loading Setting Parameters".

**Media Type**

Set the save destination medium.

**File Name**

Set the name of the file that you want to save.

**Display No.**

Set the display number of the custom display to save.

**Display Name**

Displays the display name.

**Data**

Displays the presence or absence of data.

**Procedure**

- 1** Tap **Media type** to select the medium.
- 2** Tap **File name**, and set the file name.
- 3** Tap **Display No.** to select the display number to save to.
- 4** Tap **Execute**.  
The custom display is saved.
- 5** Tap **Exit**.  
The GX/GP returns to the original screen.

[Operation complete](#)

**Saving All Displays****Path**

GX/GP: **MENU** key > **Browse** tab > **Save load** > Menu **Save settings** > **Custom display** > **Save custom display on all screen**

**Description**

Setup Item	Selectable Range or Options	Default Value
Media type	SD, USB	1
Folder name	—	—

<sup>1</sup> See page 1-226 in section 1.25.1, "Loading Setting Parameters".

**Media Type**

Set the save destination medium.

**Folder Name**

Set the save destination folder name.

**Procedure**

- 1** Tap **Media type** to select the medium.
- 2** Tap **Folder name**, and set the folder name.
- 3** Tap **Execute**.  
All custom displays are saved.
- 4** Tap **Exit**.  
The GX/GP returns to the original screen.

[Operation complete](#)

### 1.26.6 Saving Program Patterns (/PG option) (Release number 4 and later)

Each program pattern is saved to a separate file.

**Pattern file name extension**

GPT

#### Saving a Specified Pattern

Save a specified program pattern to a file name of your choice.

**Path**

GX/GP: **MENU** key > **Browse** tab > **Save load** > Menu **Save settings** > **Program pattern** > **Save specified program pattern**

**Description**

Setup Item	Selectable Range or Options	Default Value
Media type	SD/USB	1
File name	—	—
Pattern number	1 to 99	1
Pattern name	—	—
File	—	—

1 See page 1-226 in section 1.25.1, "Loading Setting Parameters".

#### Media type

Set the save destination medium.

#### File name

Set the file name.

#### Pattern number

Set the number of the pattern to save.

#### Pattern name

Displays the presence or absence of the specified pattern file.

#### File

Displays the presence or absence of the specified file.

**Procedure**

- 1** Tap **Media type** to select the medium.
- 2** Tap **File name**, and set the file name.
- 3** Tap **Pattern number** to set the pattern number.
- 4** Tap **Execute**.  
The specified pattern is saved.
- 5** Tap **Close**.  
The GX/GP returns to the original screen.

Operation complete

## Saving All Patterns

Program patterns are saved with fixed file names in the specified folder.

File name	Setting
ProgPatYY	YY: 01 to 99

### Path

GX/GP: **MENU** key > **Browse** tab > **Save load** > Menu **Save settings** > **Program pattern** > **Save all program patterns**

### Description

Setup Item	Selectable Range or Options	Default Value
Media type	SD/USB	1
Folder name	—	—

1 See page 1-226 in section 1.25.1, "Loading Setting Parameters".

### Media type

Set the save destination medium.

### Folder name

Set the folder name.

### Procedure

- 1** Tap **Media type** to select the medium.
- 2** Tap **Folder name**, and set the folder name.
- 3** Tap **Execute**.  
All patterns are saved.
- 4** Tap **Close**.  
The GX/GP returns to the original screen.

[Operation complete](#)

### 1.26.7 Saving Setting Parameters, Scale Images, Report Templates, Trusted Certificates (Release number 2 and later), Custom Display (/CG option) (Release number 2 and later), Program Pattern (/PG option) (Release number 4 and later) at Once

**Path**

GX/GP: **MENU** key > **Browse** tab > **Save load** > Menu **Save settings** > **All above**

**Description**

Setup Item	Selectable Range or Options	Default Value
Media kind	SD, USB	1
Folder name	—	—

1 See page 1-226 in section 1.25.1, "Loading Setting Parameters".

**Media kind**

Set the save destination medium.

**Folder name**

Set the folder name.

**Procedure**

- 1** Tap **Media kind**, set the medium.
- 2** Tap **Folder name**, set the folder name.
- 3** Tap **Execute**.  
All files are saved.
- 4** Tap **Exit**.  
The GX/GP returns to the original screen.

Operation complete

**Note**

The conditions for saving files depend on the contents of setting parameters, scale images, and report templates. Check the contents before saving them.



## 1.27 Listing Files That Are on the External Storage Medium

List the files on the external storage medium (SD memory card or USB flash memory (/UH option)).

### Path

GX/GP: **MENU** key > **Browse** tab > **Save load** > Menu **File list**  
 Web application: **Data** tab > **Save/Load** > **File list**

### Description

Setup Item	Selectable Range or Options	Default Value
Media kind	SD, USB	1

1 See page 1-226 in section 1.25.1, "Loading Setting Parameters".

### Media kind

Set the type of media.

### Procedure

- 1 Set the kind of media.
- 2 Tap **Execute**.  
A list of files is displayed.
- 3 Tap **OK**.  
The GX/GP returns to the original screen.

### Operation complete

### Sorting Files and Directories

Sort the files by file name, directory name, or update date/time.

- **File Name or Directory Name**  
Tap the **Name** area.  
The files are sorted in ascending or descending alphabetical order.
- **Last update**  
Tap the **Last update** area.  
The files are sorted in ascending or descending order by update date/time.

### Deleting a File

Select a file, and tap the **Delete** icon. A confirmation screen will appear. Tap **OK**. The file will be deleted.

This operation is not possible when you are using the advanced security function (/AS option).

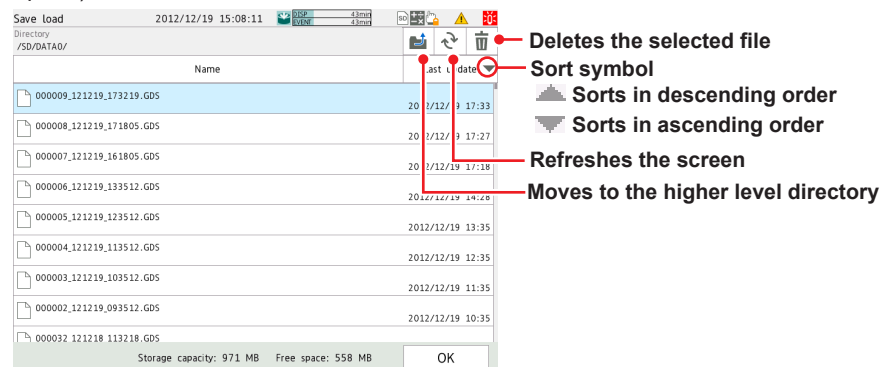

## 1.28 Formatting the External Storage Medium

Format the external storage medium (SD memory card or USB flash memory (/UH option)). This operation is not possible when you are using the advanced security function (/AS option).

### Path

GX/GP: **MENU** key > **Browse** tab > **Save load** > Menu **Format**

### Description

Setup Item	Selectable Range or Options	Default Value
Media kind	SD, USB	1
Volume name	Up to 11 characters (0 to 9, uppercase alphabet)	—

1 See page 1-226 in section 1.25.1, "Loading Setting Parameters".

### Media kind

Set the storage medium to format.

### Volume name

Set the medium volume name.

### Procedure

- 1 Tap **Media kind** to select the medium.
- 2 Set the medium volume name.
- 3 Tap **Execute**.  
The external storage medium will be formatted.
- 4 Tap **Exit**.  
The GX/GP returns to the original screen.

Operation complete

## 1.29 Initializing and Calibrating the System (Initialization, reconfiguration, touch screen calibration), Setting the Measurement Mode

Initialize the settings or the internal memory, reconfigure the GX/GP, and calibrate the touch screen.

- ▶ For details on A/D calibration, see page 5-6 in section 5.1.3, “Performing A/D Calibration and Adjusting the Input Accuracy of AI Modules”.
- ▶ For details on the advanced security settings (when the advanced security function (/AS option) is in use), see section 2.1, “Enabling/disabling the Advanced Security Function,” in the Advanced Security Function (/AS) User’s Manual (IM 04L51B01-05EN).
- ▶ For details on encryption and certificates, see page 1-260 in section 1.30, “Configuring Key Creation, Certificate Management, and Encryption/Certificate (SSL communication, PDF electronic signature) (Release number 2 and later)”.
- ▶ For details on updating the firmware (Web application, I/O module, and expansion module), see page 5-21 in section 5.1.8, “Updating the Firmware (Release number 2 and later)”.
- ▶ For the multi batch settings (multi-batch function (/BT option)), see section 2.1.1, “Settings for the Multi-batch Function,” in the Multi-batch Function (/BT) User’s Manual (IM 04L51B01-03EN).

### 1.29.1 Initializing the Settings and the Internal Memory

#### Path

GX/GP: **MENU** key > **Browse** tab > **Initialize Calibration** > **Menu Initialize** > **Settings/Internal data**

#### Description

Setup Item	Selectable Range or Options	Default Value
Initialize all	Off, On	Off

#### Initialize all

Set this to **On** to initialize all settings and return the GX/GP to its factory default condition. However, the A/D calibration password is not initialized.

Setup Item	Selectable Range or Options	Default Value
Security settings <sup>1</sup>	Off, On	Off
Control settings <sup>3</sup>	Off, On	Off
Other <sup>1</sup>	Off, On	Off
Communication(IP address) <sup>1, 2</sup>	Off, On	Off
Communication(Server settings) <sup>1, 2</sup>	Off, On	Off
Calibration correction settings <sup>1, 2</sup>	Off, On	Off
Instruments tags, etc. <sup>1, 2</sup>	Off, On	Off

1 You can set this when **Initialize all** is set to **Off**.

2 You can set this when **Other** is set to **On**. Release number 4 and later.

3 You can set this when a PID control module is detected. Release number 4 and later.

#### Security settings

Set this to **On** to initialize the security settings.

#### Control settings

Set this to **On** to initialize control settings.

Setup items that are initialized

- Control settings
- Program pattern settings
- Control event action

## 1.29 Initializing and Calibrating the System (Initialization, reconfiguration, touch screen calibration), Setting the Measurement Mode

### Other

Set this to **On** to initialize settings other than the security settings or control settings.

### Communication(IP address)

Set this to **On** to initialize the IP address, DHCP, and DNS settings.

### Communication (Server settings)

Set this to **On** when you want to initialize the server list settings, server encryption settings, and channel conversion setting of DARWIN compatible communication.

### Calibration correction settings

Set this to **On** to initialize calibration correction settings and calibration reminder settings (/ AH option).

### Instruments tags, etc.

Set this to **On** to initialize instrument tag settings.

Setup Item	Selectable Range or Options	Default Value
Internal Data	Off, On	Off

### Internal data

Set this to **On** to initialize all data in the internal memory.

## Procedure

### Initializing All Settings

- 1** Press **MENU**.  
The menu screen appears.
- 2** Tap the **Browse** tab and then **Initialize Calibration**.  
The menu screen appears.
- 3** Tap **Initialize > Settings/Internal data > Initialize all > On**.
- 4** Tap **Execute**.  
A confirmation screen is displayed.
- 5** Tap **OK**.  
The settings are initialized.

### Operation complete

### Note

- Before initializing, back up necessary setup parameters and other data.  
▶ Refer to page 1-240 in section 1.26.1, "Saving the Setting Parameters"
- Initialization does not initialize the A/D calibration password.  
If you forget the password, you will not be able to perform A/D calibration. Make sure you do not forget the password.
- When execute initialization, the message "Restart is required to reflect this changes. Continue?" may appear. Tap **OK**, and the GX/GP will automatically restart with the specified language.

## 1.29 Initializing and Calibrating the System (Initialization, reconfiguration, touch screen calibration), Setting the Measurement Mode

### Initializing a Specific Item

- 1** Press **MENU**.  
The menu screen appears.
- 2** Tap the **Browse** tab and then **Initialize Calibration**.  
The menu screen appears.
- 3** Tap **Initialize > Settings/Internal data > Initialize all > Off**.
- 4** To initialize the security settings, tap **Security settings** and then **On**. Otherwise, tap **Off**.
- 5** To initialize control settings, tap **Control settings > On**. Otherwise, tap **Off**.
- 6** To initialize the settings other than the security or control settings, tap **Other than Security settings** and then **On**. Tap the items you want to initialize to set to **On**. Otherwise, tap **Off**.
- 7** To initialize the data in the internal memory, tap **Internal data** and then **On**. Otherwise, tap **Off**.
- 8** Tap **Execute**.  
A confirmation screen is displayed.
- 9** Tap **OK**.  
The settings are initialized. The message "Execution is complete." will appear.

#### Operation complete

#### **Note**

- Before initializing, back up necessary setup parameters and other data.
  - ▶ Refer to page 1-240 in section 1.26.1, "Saving the Setting Parameters"

**1.29 Initializing and Calibrating the System (Initialization, reconfiguration, touch screen calibration), Setting the Measurement Mode**

**Explanation**

**Channel Assignment in Group Settings through Initialization**

If you initialize, channels will be automatically assigned on the basis of the installed modules. If necessary, change the channel assignments for your purpose.

Initialized Settings depending on Initialization Items

Initialized settings		Initialization item				
		Initialize all	Security settings	Control settings	Other settings	Internal data
Security settings	Security values	Yes	Yes	—	—	—
Control settings	See control setting details.	Yes	—	Yes	—	—
Other	IP address settings	Automatic IP settings	Yes	—	—	Yes
		Automatic DNS settings				
		Host name registration settings				
		IP address settings				
		DNS settings				
		Domain suffix settings				
	Host settings					
Server settings	Server list settings	Yes	—	—	Yes	—
Calibration correction settings	Calibration correction settings (excluding control settings)	Yes	—	—	Yes	—
Instruments tags, etc.	Instruments tag settings	Yes	—	—	Yes	—
			—	—	Yes	—
Internal data	Control alarm summary	Yes	—	—	—	Yes
	Control summary					
	Alarm summary					
	Message summary					
	Memory summary (display and event data)					
	Freehand image files					
Display information	Current display settings	Yes	—	—	Yes	—
	Home screen settings					
	Favorite screen settings					
	Free message settings					
Internal file	Scale image file	Yes	—	—	—	—
	Report file					
	Custom display file					
	Scale image file for data loading (for DaqStudio)					
	WEB favorite data (for Web)					
Pattern file	Pattern file (1 to 99)	Yes	—	—	—	—

Yes: Initialized settings

## 1.29 Initializing and Calibrating the System (Initialization, reconfiguration, touch screen calibration), Setting the Measurement Mode

### Control setting details

Item		
Control settings	Setup parameters	Basic control settings (control settings, contact registration, relay related)
		I/O settings
		PV, RSP settings
	Operation parameters	OUT settings
		Control alarms
		Target setpoints
		PID number/Reference point
		PID settings
	Control display	Control detail setting
		Control group settings
Loop display settings		
Program pattern settings	Screen display settings	
	Program Run/Reset message	
	Automatic switch to program operation display	
Control event action	Program RUN detail settings	
	DI/DO/Internal switch registration	

\* The following control settings are not initialized. They are initialized when **Initialize all** is specified or when **Others** is set to **On**.

Item
PID channel settings of control display
Math channel formula

### 1.29.2 Initializing Display Groups or Recording Channels Separately

You can initialize display groups or recording channels separately.

#### Path

GX/GP: **MENU** key > **Browse** tab > **Init/Calib** > menu **Initialize** > **Individual settings**

#### Description

Setup Item	Selectable Range or Options	Default Value
Display group settings	Off, On	Off
Recording channel settings	Off, On	Off

#### Display group settings

Set this to On to initialize display group settings.

#### Recording channel settings

Set this to On to recording channel settings.

## 1.29 Initializing and Calibrating the System (Initialization, reconfiguration, touch screen calibration), Setting the Measurement Mode

### Procedure

- 1 Press **MENU**.  
The menu screen appears.
- 2 Tap **Browse** tab > **Init/Calib** > menu **Initialize** > **Individual settings**.  
The menu screen appears.
- 3 To initialize display group settings, tap **Display group settings** and then **On**.  
Otherwise, tap **Off**.
- 4 To initialize recording channel settings, tap **Recording channel settings** and then **On**.  
Otherwise, tap **Off**.
- 5 Tap **Execute**.  
A confirmation screen is displayed.
- 6 Tap **OK**.  
The settings are initialized.

Operation complete

### 1.29.3 Setting the Measurement Mode

The measurement mode determines how the entire GX/GP system operates. The GX/GP measurement characteristics change depending on the measurement mode. The measurement mode must be set before reconfiguration and before specifying various settings.

Depending on the measurement mode, there are limits to the modules that can be used, the number of measurement channels and recording channels, and so on. For details, see the following general specifications.

General Specifications Name	General Specifications No.
GX/10/GX20 Paperless Recorder (panel mount type)	GS 04L51B01-01EN
GP10/GP20 Paperless Recorder (portable type)	GS 04L52B01-01EN

### Path

GX/GP: **MENU** key > **Browse** tab > **Init/Calib** > menu **Measurement mode**

### Description

Setup Item	Selectable Range or Options	Default Value
Measurement mode	Normal, High speed, Dual interval	Normal

#### Measurement mode

Set the measurement mode according to the measurement conditions.

Options	Description
Normal	Data collection (measurement and recording) can be performed at 100 ms minimum.
High speed	Data collection (measurement and recording) can be performed at 1 ms minimum.
Dual interval	Data collection (measurement and recording) can be performed at two different scan intervals.

### Procedure

- 1 Tap **Measurement mode**.  
The available measurement modes are displayed.
- 2 Set the measurement mode, and tap **Execute**.  
A confirmation screen is displayed.
- 3 Tap **OK**.  
The measurement mode is changed.

Operation complete



## 1.29 Initializing and Calibrating the System (Initialization, reconfiguration, touch screen calibration), Setting the Measurement Mode

### Note

- When the measurement mode is changed, the system restarts, and the following data is initialized. Set the measurement mode before reconfiguration and before specifying various settings.

#### Initialized settings

All internal data

All setting parameters including security settings but excluding communication settings

System configuration data

- You cannot set the measurement mode when recording, computation, or control execution is in progress.
- The measurement mode setting is not initialized through the initialization of settings.
- Measurement mode setting is not saved in setting parameter files.
- If the advanced security function (/AS) or multi-batch function (/BT) is enabled (On), the measurement mode is fixed to Normal. To change the measurement mode, disable the advanced security function (/AS) and multi-batch function (/BT).
- When the login function is in use, only system administrators can set the measurement mode.
- If the operation lock function is enabled and System operation is set to Lock, you cannot set the measurement mode.

### Description

By switching the measurement mode according to the measurement target and measurement conditions, you can perform high-speed measurements as well as simultaneous high-speed and low-speed measurements.

In high-speed measurement, a high-speed AI module can be installed to achieve measurement at the shortest interval of 1 ms.

In dual interval measurement, measurement can be performed by two measurement groups with different scan intervals.

### 1.29.4 Reconfiguring the GX/GP

When you reconfigure the GX/GP, the I/O modules installed in the GX/GP, expandable I/O, and GM sub unit are detected, and the settings are changed accordingly. Reconfiguration is necessary in the following situations.

- When you install a newly purchased module
- When you change the modules (change to different modules)
- When you add or remove modules
- When you connect or add an expandable I/O
- When the measurement mode is changed
- When the advanced security function on/off state is changed

If you purchased a I/O module preinstalled option (/U□□0 or /CR□□0), there is no need to reconfigure if you are going to use the GX/GP as-is. However, if you change modules, add modules, or delete modules, you will need to reconfigure.

**Path**

GX/GP: **MENU** key > **Browse** tab > **Initialize Calibration** > **Menu Reconfiguration**

**Procedure**

- 1 Tap **Execute**.  
The system information appears.

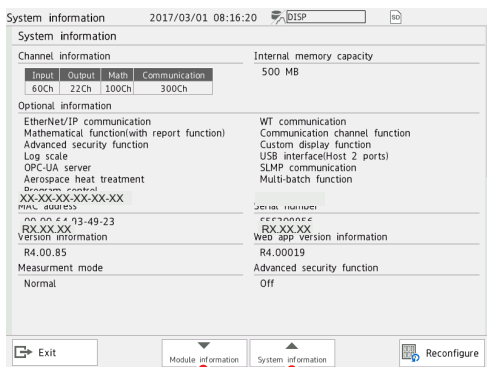

Switches the display

- 2 Tap **Restructure**.  
A confirmation screen is displayed.
- 3 Tap **OK**.  
The GX/GP will reconfigure.

Operation complete

## 1.29 Initializing and Calibrating the System (Initialization, reconfiguration, touch screen calibration), Setting the Measurement Mode

### Note

- Do not carry out the following operations while the GX/GP is reconfiguring. Doing so may cause damage.  
Turn the power off and on.  
Insert or remove modules.
- If turn off a expansion module and turn it back on, after checking the connected module, execute reconfiguration.
- If the total number of I/O channels of the installed modules exceeds 100 on the GX10/GP10/ GX20-1/GP20-1 or 500 on the GX20-2/GP20-2, no additional modules can be reconfigured. For example, if the maximum number of I/O channels are assigned and the last channel is assigned to an intermediate channel of an installed I/O module, that module and subsequent modules will not be reconfigured or identified.

#### Example GX10/GX20-1

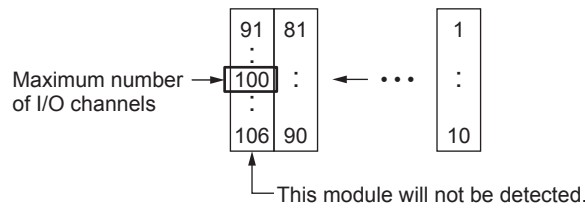

- If the measurement mode is high speed, dual interval or if the advanced security function is enabled, PID control modules will not be identified.
- During reconfiguration, the output channel is turned off or de-energized. In addition, for models with the program control function (/PG), the program pattern is changed when the PID control module is removed.

### Conditions on the Combination of Firmware Versions and Modules

The module versions that can be detected depending on the firmware version are as follows. If an installed module cannot be detected, update the firmware.

Name	Model	Module		Firmware Version
		Type		
Analog Input	GX90XA	-U2 (Universal)		R1.01.X or later
		-T1 (Electromagnetic relay)		R1.03.X or later
		-C1 (Current (mA))		R2.01.X or later
		-L1 (Low withstand voltage)		R2.01.X or later
		-H0 (High-speed universal)		R4.01.X or later
		-R1 (4-wire RTD/resistance)		R4.01.X or later
		-V1 (High withstand voltage)		R4.03.X or later
Digital Input	GX90XD			R1.01.X or later
Digital Input/Output	GX90WD			R2.01.X or later
Digital Output	GX90YD			R1.01.X or later
Pulse Input	GX90XP			R3.01.X or later
Analog output	GX90YA			R3.02X or later
PID control	GX90UT			R4.01.X or later
Expansion Module	GX90EX			R2.01.X or later

### 1.29.5 Adjusting the Touch Screen

- See page 5-18 in section 5.1.6, "Adjusting and Checking the Touch Screen".

## 1.30 Configuring Key Creation, Certificate Management, and Encryption/Certificate (SSL communication, PDF electronic signature) (Release number 2 and later)

Configure these settings when using SSL encryption and PDF electronic signatures. To use encryption on the FTP server and HTTP server and to use PDF electronic signature, you must create a key and install a certificate.

SSL (Secure Sockets Layer)

SSL is a function for encrypting data communication between devices on the Internet and other networks. It ensures safe data transmission such as by preventing spoofing by other devices and data eavesdropping.

### 1.30.1 Enabling the Encryption Function

When you enable the encryption function, the GX/GP restarts. After the GX/GP restarts, you need to perform various configuration and operations.

#### Path

GX/GP: **MENU** key > **Browse** tab > **Init/Calib** > menu **Encryption/Certificate**

#### Description

Setup Item	Selectable Range or Options	Default Value
Encryption function	Off, On	Off

#### Encryption Function

Select **On** to use the encryption function.

#### Procedure

- 1 Tap **Encryption function** to select **On**.
- 2 Tap **Execute**.  
A confirmation screen is displayed.
- 3 Tap **OK**.  
The GX/GP restarts, and you can set the various items of the encryption function.

[Operation complete](#)

### 1.30.2 Creating a Key

#### Path

GX/GP: **MENU** key > **Browse** tab > **Init/Calib** > menu **Encryption/Certificate** > **Create a key**

#### Description

Setup Item	Selectable Range or Options	Default Value
Key	—	—

#### Key

Displays the presence or absence of a key.

**Procedure**

- 1** Tap **Execute**.  
A confirmation screen is displayed.
- 2** Tap **OK**.  
The GX/GP switches to key creation mode, and a key is created.  
  
To cancel the operation, tap **Cancel**.  
A confirmation screen will appear. Tap **Yes**. The GX/GP will restart.  
If you tap **No**, key creation will continue.
- 3** After the key is created, a confirmation screen appears. Tap **OK**.  
The GX/GP restarts.

Operation complete

### 1.30.3 Configuring Certificate Management (Creating self-signed certificates, creating certificate signature requests (CSRs), installing certificates, and installing intermediate certificates)

**Path**

GX/GP: **MENU** key > **Browse** tab > **Init/Calib** > menu **Encryption/Certificate** > **Certificate management**

**Description**

Setup Item	Selectable Range or Options	Default Value
Certificate for communication	—	—
Certificate for PDF signature	—	—

**Certificate for Communication**

Displays the presence or absence of a certificate for communication.

**Certificate for PDF Signature**

Displays the presence or absence of a certificate for PDF signature.

**Creating a Self-Signed Certificate**

**Path**

GX/GP: **MENU** key > **Browse** tab > **Init/Calib** > menu **Encryption/Certificate** > **Certificate management** > **Creating a self-signed certificate**

**Description**

Setup Item	Selectable Range or Options	Default Value
Country	Character string (up to 2 characters, <u>Aa</u> )	—
State	Character string (up to 64 characters, <u>Aa#1</u> )	—
City	Character string (up to 64 characters, <u>Aa#1</u> )	—
Common name	Character string (up to 64 characters, <u>Aa#1</u> )	—
Organization	Character string (up to 64 characters, <u>Aa#1</u> )	—
Organization unit	Character string (up to 64 characters, <u>Aa#1</u> )	—
E-mail	Character string (up to 64 characters, <u>Aa#1</u> )	—
Use	Communication/PDF signature	Communication

**Country**

Set the ISO country code. (United States country code: US)

**State**

Set the state.

**City**

Enter the city name.

**Common Name**

Set the URL (FQDN) of the site that will use SSL encrypted communication. This must match the URL that the clients specify to establish SSL connection.

**Organization**

Set the official English name of the organization that will manage the server. Enter the official organization name including the suffix such as inc., Co.ltd, K.K.

**Organization Unit**

Set the division, department, or other names for identification.

**E-mail**

Set the E-mail address.

**Use**

Set the use of the self-signed certificate.

**Procedure**

- 1 Tap Country, State, City, Common name, Organization, Organization unit, and E-mail, and set them.
- 2 Tap **Use**, and set the use of the self-signed certificate.
- 3 Tap **Execute**.  
A self-signed certificate is created.
- 4 Tap **Close** to return to the original screen.

Operation complete

**Creating a Certificate Signature Request (CSR)**

To apply and obtain a certificate, create a certificate signature request (CSR) to be submitted to a certification authority.

**Path**

GX/GP: **MENU** key > **Browse** tab > **Init/Calib** > menu **Encryption/Certificate** > **Certificate management** > **Creating a certificate request(CSR)**

**Description**

Setup Item	Selectable Range or Options	Default Value
Country	Character string (up to 2 characters, <u>Aa</u> )	—
State	Character string (up to 64 characters, <u>Aa#1</u> )	—
City	Character string (up to 64 characters, <u>Aa#1</u> )	—
Common name	Character string (up to 64 characters, <u>Aa#1</u> )	—
Organization	Character string (up to 64 characters, <u>Aa#1</u> )	—
Organization unit	Character string (up to 64 characters, <u>Aa#1</u> )	—
E-mail	Character string (up to 64 characters, <u>Aa#1</u> )	—

**Country, State, City, Common Name, Organization, Organization Unit, and E-mail**

These items are the same as those explained in “Creating a Self-Signed Certificate.”

Setup Item	Selectable Range or Options	Default Value
Media type	SD, USB	1
File name	—	—

1 See section 1.20.1, “Loading Setting Parameters.”

**Media Type**

Set the save destination medium.

**File Name**

Set the name of the file that you want to save.

**Procedure**

- 1 Tap Country, State, City, Common name, Organization, Organization unit, and E-mail, and set them.
- 2 Tap **Media type** to select the storage medium.
- 3 Tap **File name**, and set the file name.
- 4 Tap **Execute**.  
A certificate signature request (CSR) is created.
- 5 Tap **Close** to return to the original screen.

Operation complete

**Installing a Certificate**

You need to place the certificate to be installed in an external storage medium.

**Path**

GX/GP: **MENU** key > **Browse** tab > **Init/Calib** > menu **Encryption/Certificate** > **Certificate management** > **Installation of certificate**

**Description**

Setup Item	Selectable Range or Options	Default Value
Media type	SD, USB	1
Select file	—	—
Use	Communication/PDF signature	Communication

1 See section 1.20.1, "Loading Setting Parameters."

**Media Type**

Set the storage medium to load from.

**Select File**

Select the certificate to install.

**Use**

Set the use of the certificate.

**Procedure**

- 1 Tap **Media type** to select the medium.
- 2 Tap **Select file** to select the certificate to install.
- 3 Tap **Use**, and set the use of the certificate.
- 4 Tap **Execute**.  
The certificate is installed.
- 5 Tap **Close** to return to the original screen.

Operation complete

### Installing an Intermediate Certificate

You need to place the intermediate certificate to be installed in an external storage medium.

#### Path

GX/GP: **MENU** key > **Browse** tab > **Init/Calib** > menu **Encryption/Certificate** > **Certificate management** > **Installation of intermediate certificate**

#### Description

Setup Item	Selectable Range or Options	Default Value
Media type	SD, USB	1
Select file	—	—
Use	Communication/PDF signature	Communication

1 See section 1.20.1, "Loading Setting Parameters."

#### Media Type

Set the storage medium to load from.

#### Select File

Select the intermediate certificate to install.

#### Use

Set the use of the certificate.

#### Procedure

- 1 Tap **Media type** to select the medium.
- 2 Tap **Select file** to select the intermediate certificate to install.
- 3 Tap **Use**, and set the use of the intermediate certificate.
- 4 Tap **Execute**.  
The intermediate certificate is installed.
- 5 Tap **Close** to return to the original screen.

[Operation complete](#)

## 1.30.4 Viewing Certificate Details and Removing Certificates

### Viewing Certificate Details

#### Path

GX/GP: **MENU** key > **Browse** tab > **Init/Calib** > menu **Encryption/Certificate** > **View certificate**

#### Description

Setup Item	Selectable Range or Options	Default Value
Select file	—	—

#### Select File

Select the certificate that you want to view.

#### Certificate Information

Setup Item	Selectable Range or Options	Default Value
Issuer	—	—
Subject	—	—
Valid not before	—	—
Validity not after	—	—
Front half of hash value (SHA1)	—	—
Latter half of hash value (SHA1)	—	—



**Issuer**

Displays the issuer information.

**Subject**

Displays the subject information.

**Valid Not Before**

Displays the start date of the valid period.

**Validity Not After**

Displays the end date of the valid period.

**Front Half of Hash Value (SHA1)**

Displays the front half of the certificate's hash value.

**Latter Half of Hash Value (SHA1)**

Displays the latter half of the certificate's hash value.

**Instrument information**

Setup Item	Selectable Range or Options	Default Value
Serial No.	—	—

**Serial No.**

Displays the GX/GP serial number.

**Procedure**

- 1 Tap **Select file** to set the certificate you want to view.
- 2 Tap **OK**.  
The certificate details are displayed.
- 3 Tap **Close** to return to the original screen.

Operation complete

**Deleting a Certificate**

**Path**

GX/GP: **MENU** key > **Browse** tab > **Init/Calib** > menu **Encryption/Certificate** > **Remove certificate**

**Description**

The displayed items are the same as those described in “Viewing Certificate Details.”

**Procedure**

- 1 Tap **Select file** to set the certificate to be deleted.  
The certificate details are displayed.
- 2 Tap **Execute**.  
A confirmation screen is displayed.
- 3 Tap **OK**.  
The certificate is deleted.
- 4 Tap **Close** to return to the original screen.

Operation complete

## 1.30.5 Configuring the Encryption of the Server Function and Client Function, and Applying PDF Electronic Signatures

### Configuring the Server Function

Set the encryption of the FTP server and HTTP server.

- ▶ For details on the settings, see page 1-196 in section 1.21.9, "Setting the Server Functions to Use (FTP, HTTP, SNMP, MODBUS, GENE, DARWIN compatible communication)".

### Configuring the Client Function

Set the encryption of the FTP client and SMTP client.

- ▶ For details on the settings, see page 1-184 in section 1.21.2, "Configuring the FTP Client Function" and page 1-186 in section 1.21.3, "Configuring the SMTP Client Function".

### Setting the PDF Electronic Signature

Set the electronic signature of PDF files.

- ▶ For details on the settings, see page 1-151 in section 1.16.1, "Setting the Report Type, Creation Time, Data Type, Etc.".

## 1.30.6 Loading, Deleting, and Saving a Trusted Certificate

- ▶ For details on loading and deleting, page 1-232 in section 1.25.4, "Loading and Deleting Trusted Certificates (Release number 2 and later)".  
For details on saving, see page 1-244 in section 1.26.4, "Saving Trusted Certificates (Release number 2 and later)".

## 1.30.7 Verification Confirmation of Unverified Certificates

If a certificate that you have cannot be verified as a new certificate, an error message (E782) appears, and a Unverified certificate icon appears in the Universal menu. Communication continues by performing verification confirmation.

- ▶ For details on the verification confirmation, see page 2-73 in section 2.4.11, "Verifying Unverified Certificates (Release number 2 and later)".

## 1.31 Using the DARWIN Compatible Communication Function (Release number 2 and later)

This section provides an outline on how to use the DARWIN compatible communication function and how to configure it.

### 1.31.1 Overview

A portion of the DARWIN's setting and control commands is supported. Measured data, math data, and so on can be output in DARWIN format. You can use an existing program that has been created for DARWIN to communicate with the GX/GP.

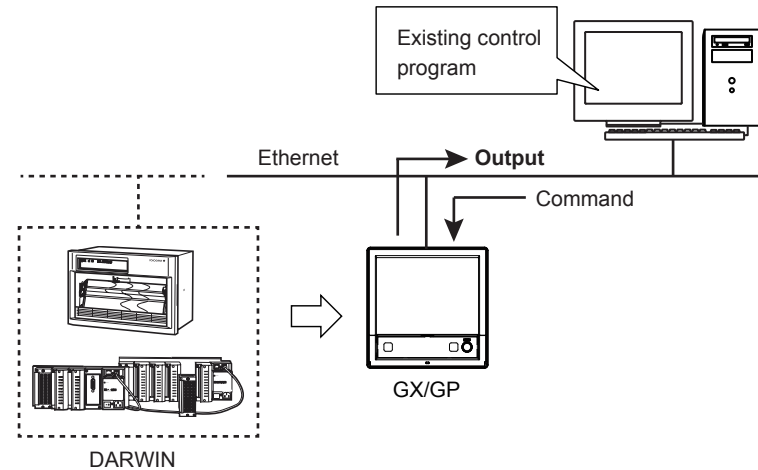

#### Note

The following application programs and API are not supported. You cannot communicate with the GX/GP using the following programs and API through the DARWIN compatible communication function.

- DAQ32, DAQ32Plus, DAQLogger
- MX190 (API for MX100/DARWIN)
- LabVIEW driver (for DARWIN)

### Instrument Configuration

To control the GX/GP using the DARWIN compatible communication function, you must configure the GX/GP (module type, channel numbers (unit numbers and slot numbers)) to match DARWIN.

For details on channel conversion, see page 1-196 in section 1.21.9, "Setting the Server Functions to Use (FTP, HTTP, SNMP, MODBUS, GENE, DARWIN compatible communication)" (for Ethernet communication) or page 1-200 in section 1.22.1, "Setting Basic Communication Conditions" (for serial communication).

### Module Configuration Example

Unit	DARWIN (Extended type)	GX/GP
Main unit	Main	GX/GP main unit
	Slots 0 to 8	No module
Sub unit, extended unit	DS600	GX60
	Slot 0	DU100-11
	Slot 1	DU100-11
	Slot 2	DU100-11
	Slot 3	No module
	Slot 4	DU100-11
	Slot 5	No module

### Interface

Ethernet, RS-232<sup>1</sup>, RS-422/485<sup>1</sup>

<sup>1</sup> Release number 2 (version 2.02) and later

### 1.31 Using the DARWIN Compatible Communication Function (Release number 2 and later)

#### Communication Ports and Maximum Number of Connections (When Ethernet)

Port Number	Maximum Number of Connections	Notes
34150	1	RS232C command support, configuration port
34151	4	Loading instantaneous data

- Port 34159 (communication status verification) cannot be used.

#### Connection Limitation (Release number 3 (Version 3.02) and later)

- Connection can be limited using the port limitation setting command (SDarwinPortLimit).
- When port limitation is on, the limitation is the same as that of DARWIN. When connected via Ethernet, only instantaneous data reading is possible on port number 34151. Configuration, control, and operation are not possible. When connected via serial, only the commands that can be used on a Ethernet connection through port 34150 are valid.
- When port limitation is off (default value), there are no limitations on commands on either port. All supported commands work on both ports.
- For details on communication commands, see the Communication Interface User's Manual (IM 04L51B01-17EN).

#### Terminator

Classification	Terminator
Input	CR+LF or LF
Output	CR+LF

#### Procedure to Use the GX/GP

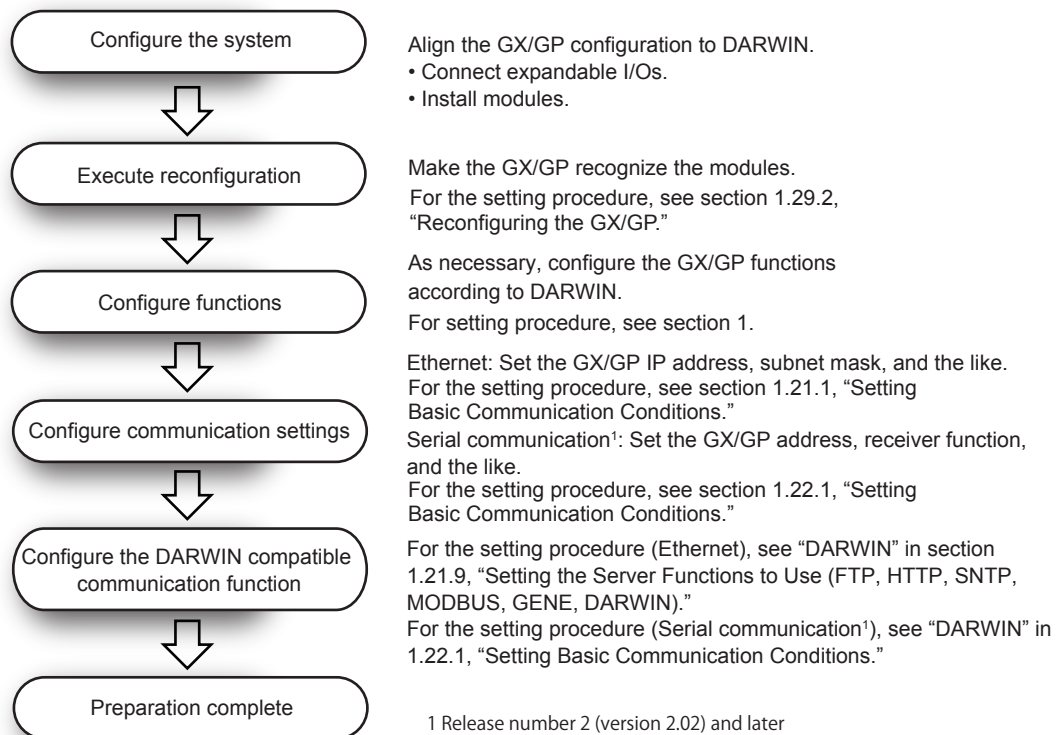

## 1.31.2 Supported Commands

The commands supported by the DARWIN compatible communication function are as follows.

### Instantaneous Data Output Commands

Command	Description
EF	Outputs measured data and math data in binary format.
EL	Outputs unit and decimal point information of a specified channel in ASCII format.
EB	Sets the byte output order.

\* DO, DIO, AO, and PID control modules cannot output measured data or decimal point information.

### ESC+T Command

If a "Esc+T" command is received, time-synchronized measured value and math value are held in the local buffer until the next "Esc+T" command is received.

Command	Description
Esc+T	Prepares to output the data selected with the TS command.

### Setting Commands

Command	Description
SR	Sets the range.
SN	Sets the unit (scale unit).
SA	Sets an alarm.
SD	Sets the date and time.
SV	Sets moving average.
CM	Sets math input data (option).
SC <sup>1,3</sup>	Sets the chart speed.
SZ <sup>1,4</sup>	Sets the recording zone.
PT <sup>1,3</sup>	Turns on or off trend recording.
AO <sup>1</sup>	Assigns a reference channel to the retransmission output channel. <sup>2</sup>

1 Release number 4 and later

2 Setting a channel set to manual output will result in error.

3 Only an affirmative response is returned on the GX/GP because this is not supported.

4 The percentage is converted into a print width. On the GX20/GP20, 0 to 100% is converted 0 to 250 mm. On the GX10/GP10, 0 to 100% is converted to 0 to 150 mm.

### SR Command Parameters

If a setting parameter that the GX/GP does not support is received, a negative response is returned.

Item	Description
Mode	RRJC
Range	PT2, JPT2, PT2S, JPT2S, GATE
Module	AC, STRAIN

### Note

- When the mode is SCL  
Sending a command without a parameter may cause an E1 error.  
If an error occurs, do not omit the parameters.
- When the mode is PULSE  
Setting is not possible with just the SR command. Set the range setting data type to scaling, and then send the command.

### 1.31 Using the DARWIN Compatible Communication Function (Release number 2 and later)

#### Commands Applicable to RS-422-A/RS-485 Only (Release number 2 (version 2.02) and later)

Command	Description
Esc+O	Open Command (address a communication destination)
EXC+C	Close Command (close the addressed state of a device)

#### Data Output Request Commands

Command	Parameter	Description
TS	0: Measured data	Selects the talker output data.
	1: Setting parameters	
	2: Unit information	
	5: System configuration information	
	9: Setup mode setting data output	
FM	0: Measured data (ASCII)	Selects the output format of measured/math data.
	1: Math data (binary)	
	2: Math data (ASCII)	
	3: Math channel (binary)	
LF	—	Sets the output channel for the setting data output, unit, and decimal place information.
CF	—	Sets the system configuration data format.
VF	—	Relay status output request
BO	—	Sets the byte output order.
Esc+S <sup>1</sup>	—	Status byte output command

<sup>1</sup> Release number 2 (version 2.02) and later

#### Responses to Output Request Commands

AO module channels are not output in response to the following command.

Command	Setting
FM	Selects the output format of measured/math data.
EF	Measured data and math data (binary format)
LF	Sets the output channel for the unit and decimal place information.
EL	Unit and decimal point information of a specified channel (ASCII format)

#### Module Names Output by the CF Command

GX/GP Module	Module Name
AI module	INPUT
DI module	DI
DO module	RELAY
Expansion module	Module not connected
Module error	XXXXXX
DI/DO module	REMOTE
Pulse input module	PULSE
AO module	OUTPUT
PID control module	PID

### 1.31 Using the DARWIN Compatible Communication Function (Release number 2 and later)

#### Setting Output Format

When you execute the command TS1 + device trigger (ESC+T) + LF, the operation mode parameters are output in the following order.

PS <sup>1</sup>	Recording start/stop information	CrLf
SR	Measurement range setting data of the first channel	CrLf
		...
SR	Measurement range setting data of the last channel	CrLf
SN	Unit setting data of the first channel	CrLf
		...
SN	Unit setting data of the last channel	CrLf
SA	Alarm setting data of the first channel	CrLf
		...
SA	Alarm setting data of the last channel	CrLf
SZ	Alarm setting data of the last channel	CrLf
		...
SZ	Alarm setting data of the last channel	CrLf
SV	Moving average setting data of the first channel	CrLf
		...
SV	Moving average setting data of the last channel	CrLf
AO	Retransmission output setting data of the first channel	CrLf
		...
AO	Retransmission output setting data of the first channel	CrLf
EN	Output end	CrLf

Because the command TS9 + device trigger (ESC+T) + LF is not supported, only the EN line will be output.

<sup>1</sup> When the multi-batch function (/BT option) is enabled, the status of the first batch is output.

#### Control Execution Commands

Command	Description
AR	Resets alarms.
IR	Resets timers.
EX	Starts, stops, resets, clears (option) math.
RS	System reconfiguration
RC	Clears RAM (initializes operation mode setting parameters).
VD	Turns on and off relays externally.
CF	System configuration data output request (diagnosis)
PS	Starts or stops recording.
MS	Starts message printing.
IM <sup>1</sup>	Sets the interrupt mask.
SM <sup>1</sup>	Sets the auxiliary mask.

<sup>1</sup> Release number 2 (version 2.02) and later

#### Command Operation When the Multi-batch Function (/BT) Is Enabled (Release number 3 and later)

This section explains the operation of the following commands when the multi-batch function is enabled.

Command	Operation
PS	Starts/stops recording of the first batch
EX	Starts, stops, resets, clears computation
MS	Writes a message to all groups in the first batch

### 1.31 Using the DARWIN Compatible Communication Function (Release number 2 and later)

#### Handling of Commands for Functions Not Available on the GX/GP

If a command or parameter for a function not available on the GX/GP is received, a negative response (E1) is returned.

However, if the command does not constitute a functional problem, a positive response (E0) is returned without performing any operation.

#### Commands That the GX/GP Returns Positive Responses For

Command	Description	Response	Operation
DS	Switches the setting mode.	Positive	No operation
XE	Confirms setup setting parameters.	response	
UD	Sets the display mode of the top display.		
SC	Sets the chart speed.		
PT	Turns on or off trend recording.		
ESC+R	Switch from Local Status to Remote Status.		
ESC+L	Sets the display mode of the top display.		

#### Commands That Do Not Affect the Operation (Negative response)

Command	Description	Response	Operation
SX	Sets a math group.	Negative	No effect
SI	Sets a timer (option).	response	
SQ	Sets a match time timer (option).		
SL	Sets event/action (option).		
SO	Sets a calculation expression (option).		
SK	Sets a calculation constant (option).		
AO	Assigns a transmission channel.		
YO	Sets the time constant for transmission output.		
ET	Sets a timeout.		

If ASCII codes E2 to E6 ( $\Omega$ ,  $\mu$ ,  $\varepsilon$ ,  $\upsilon$ ) are received, they are converted to spaces, and no error results. The E1 character ( $^{\circ}$ ) is converted to the GX/GP character code C2B0 and applied.

#### Handling depending on the Measurement Mode

Measurement mode	Setting
Normal	All the channels of detected modules are output (except for DO, DIO, AO, and PID modules).
High speed	Of the detected modules, only the AI channels are output.
Dual interval	Of the detected modules, only the channels of measurement groups using the master interval are output (except for DO, DIO, AO, and PID modules).

#### Command That Runs When the Measurement Mode Is Set to Dual Interval

Command	Setting
EX	Starts, stops, resets, clears computation (master interval).
PS	Starts, stops recording of both measurement group 1 and 2.
MS	Writes messages to all display groups.

#### Handling of Settings Available on the GX/GP but Not on DARWIN

Settings that are available on the GX/GP but not on DARWIN are output as follows.

Command	Item	Setting
SR	High-speed AI module's voltage (VOLT) at 100 V range	100V
	4-wire RTD module's RTD at PT500 range	Pt500
	4-wire RTD module's RTD at PT1000 range	Pt1000
	4-wire RTD module's type is resistance (OHM)	OHM
	4-wire RTD module's resistance (OHM) at 20 ohm range	20ohm
	4-wire RTD module's resistance (OHM) at 200 ohm range	200ohm
	4-wire RTD module's resistance (OHM) at 2000 ohm range	2000ohm
	AI module's general signal	GS
AO	DO module's PULSE	DIPULSE
	When the type is manual output	ManualAO



### 1.31.3 Configuring the DARWIN Compatible Communication Function

When Ethernet (Release number 2 (version 2.02) and later)

#### Path

GX/GP: **MENU** key > **Browse** tab > **Setting** > Setting menu **Communication (Ethernet) settings > Server settings > Server list**

Web application: **Config.** tab > **Communication (Ethernet) settings > Server settings Server list**

Hardware configurator: **Communication (Ethernet) settings > Server settings Server list**

#### Description

#### DARWIN

Setup Item	Selectable Range or Options	Default Value
On, Off	Off, On	Off
Channel conversion <sup>1</sup>	Stand-alone type, extended type	Stand-alone type

<sup>1</sup> Appears when the On/Off settings is set to On.

#### On/Off

Select **On** to use the DARWIN compatible communication function.

#### Channel Conversion

Set the DARWIN type to perform channel conversion.

When serial communication (Release number 2 (version 2.02) and later)

#### Path

GX/GP: **MENU** key > **Browse** tab > **Setting** > Setting menu **Communication (Serial) settings > Basic settings**

Web application: **Config.** tab > **Communication (Serial) settings > Communication (Serial) basic settings**

Hardware configurator: **Communication (Serial) settings > Communication (Serial) basic settings**

#### Description

#### DARWIN

Setup Item	Selectable Range or Options	Default Value
Channel conversion <sup>1</sup>	Stand-alone type, extended type	Stand-alone type

<sup>1</sup> Appears when the receiver function settings is set to **DARWIN**.

#### Channel Conversion

Set the DARWIN type to perform channel conversion.

### 1.31.4 Configuring the GX/GP IP Address, Subnet Mask, and the Like (for Ethernet)

► See page 1-182 in section 1.21.1, “Setting Basic Communication Conditions”.

### 1.31.5 Configuring the GX/GP’s Basic Serial Communication Conditions (for RS-232, RS-422/485) (version 2.02 and later)

► See page 1-200 in section 1.22.1, “Setting Basic Communication Conditions”.

## 1.32 Using the Aerospace Heat Treatment (/AH option) (Release number 3 and later)

This section explains calibration reminder settings for periodically performing calibration correction settings and the like.

When the notification date set using the calibration reminder function arrives, the notification content is shown on a notification screen.

It can be used to remind you of the schedule.

From the notification screen or reminder, you can set the due date and the calibration correction of AI channels, PID control module's input terminal (AI number) (Release 4 and later) and Communication channels (Release 4 (version 4.02) and later).

- ▶ For details on the calibration correction of AI channels, see page 1-53 in section 1.2.4, "Setting Calibration Correction (Linearizer approximation, linearizer bias, Correction Factor 1 (release number 3 and later))".
- ▶ For details on the calibration correction of the PID control module's input terminal (AI number), see section 3.4.5, "Performing Calibration Correction," in the *Loop Control Function, Program Control Function (/PG Option) User's Manual* (IM 04L51B01-31EN).
- ▶ For details on the calibration correction of the Communication channels, see page 1-179 in section 1.20.4, "Setting Calibration Correction (Linearizer approximation, linearizer bias, Correction Factor 1 (release number 4 (version 4.02) and later))".

### 1.32.1 Setting the Calibration Reminder

#### Path

GX/GP: **MENU** key > **Browse** tab > **Setting** > Setting menu **Calibration reminder settings**  
 Web application: **Config.** tab > **Calibration reminder settings**  
 Hardware configurator: **Calibration reminder settings**

#### Description

Setup Item	Selectable Range or Options	Default Value
Schedule number	GX10, GX20-1, GP10, GP20-1: 1, 2, 3, 4, 5, 6 GX20-2, GP20-2: 1, 2, 3, 4, 5, 6, 7, 8, 9, 10, 11, 12	1

#### Schedule number

Select the registration number for registering a schedule.

#### Reminder function

Setup Item	Selectable Range or Options	Default Value
On/Off	Off, On	Off

#### On/Off

Set this to **On** to register a schedule.

#### Due date

Setup Item	Selectable Range or Options	Default Value
Due date	January 1, 2001 to December 31, 2035	January 1, 2012
Daily reminder	1 day before to 10 days before in unit of days	5 days before
Re-notification cycle	10min/30min/1h/8h/24h	1h

#### Due date

From a calendar, set the reminder date.

Use the year switch icons (◀, ▶) to change the due date in unit of years.

Use the year switch icons (◀, ▶) to change the due date in unit of months.

## 1.32 Using the Aerospace Heat Treatment (/AH option) (Release number 3 and later)

### Daily reminder

Set how many days before to start reminders using the notification screen.

### Re-notification cycle

Set interval for showing reminders using the notification screen.

### Notification contents

Setup Item	Selectable Range or Options	Default Value
Title	Character string (up to 32 characters, $\overline{\text{Aa\#1}}$ )	—
Notification message 1	Character string (up to 32 characters, $\overline{\text{Aa\#1}}$ )	—
Notification message 2	Character string (up to 32 characters, $\overline{\text{Aa\#1}}$ )	—
Buzzer	Off, On	Off

### Title

Set the title to show on the notification screen.

### Notification message 1, 2

Set the notification contents.

### Buzzer

Set this to On to sound the buzzer.

### Due date setting display

Setup Item	Selectable Range or Options	Default Value
Calibration correction settings	Off, On	Off

### Calibration correction settings

Set this to On to show the calibration correction settings of AI channels, PID control module's input terminal (AI number) and Communication channels in the due date setting of the notification screen.

## 1.32.2 Notification Screen Display

When a daily reminder date arrives, a notification screen appears at 00:00 (HH:MM).

This screen reappears at the re-notification cycle.

If the buzzer is enabled, a buzzer is sounded when the notification screen appears.

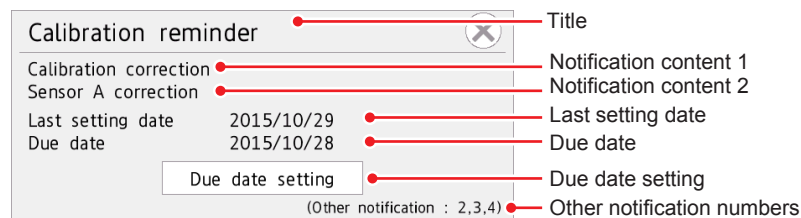
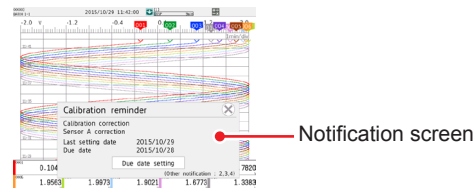

Contents displayed the notification screen

- Tap Due date setting to switch to the due date setting screen where you can reset the due date and perform calibration correction (based on settings).
- ▶ For details on Due date setting, see page 1-276 in section 1.32.3, "Resetting the Calibration Reminder Due Date, Performing Calibration Correction".

**1.32 Using the Aerospace Heat Treatment (/AH option) (Release number 3 and later)**

- If another notification screen appears when a notification screen is already displayed, the one with the closer due date is prioritized.  
For notifications other than the prioritized one, only their schedule numbers are displayed in the form (Other notification: \*,\*,\*).

**Operation Example**

Daily reminder setting: 1 (day before), re-notification cycle: 8h

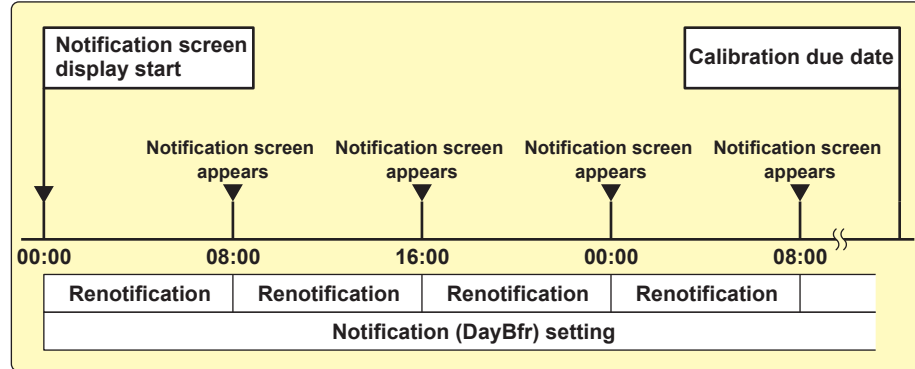

**Stopping the Buzzer**

To stop the buzzer, close the notification screen or perform the following operation.  
**MENU** key > **Universal** tab > **Buzzer ACK**

**1.32.3 Resetting the Calibration Reminder Due Date, Performing Calibration Correction**

From the notification screen or **Due date setting** of a reminder, you can set the due date, control settings, the calibration correction of AI channels and communication channels.

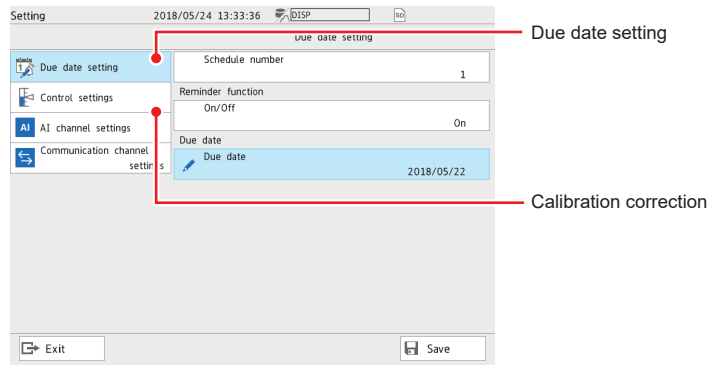

**Procedure**

**Due date setting**

- 1 Tap **Due date setting** on the setting menu.  
Due date setting appears.
- 2 Tap **Schedule number** to set the number of the schedule you want to change.

**Resetting the due date**

- 3 Tap **Due date**. From the calendar, specify a new due date, and tap **OK**.  
The due date is reset.
- 4 Tap **Save** to set the new due date.

Operation complete

### When Not Using the Reminder Function

**3** Tap **On/Off** under Reminder function to select **Off**.

**4** Tap **Save** to set the reminder function to off.

[Operation complete](#)

### Calibration correction

**1** Tap **AI channel settings** on the setting menu.  
The AI channel settings screen appears.

**2** Tap **Calibration correction**.  
The calibration correction settings are displayed.

**3** Set the first channel and last channel.

**4** If necessary, set the mode and the number of set points.

**5** Set the calibration correction of each set point.

► For details on settings, see page 1-53 in section 1.2.4, "Setting Calibration Correction (Linearizer approximation, linearizer bias, Correction Factor 1 (release number 3 and later))".

[Operation complete](#)

### Calibration Correction of Control Settings

**1** Tap **Control settings** on the setting menu.  
The Control settings screen appears.

**2** Tap **Calibration correction**.  
The calibration correction settings are displayed.

**3** Tap **Unit No.** and set the unit.

**4** Tap **Slot Number** and set the slot.

**5** Tap **AI number** and set the AI input.

**6** If necessary, set the mode and the number of set points.

**7** Set the calibration correction of each set point.

► For details on the settings, see page 1-53 in section 1.2.4, "Setting Calibration Correction (Linearizer approximation, linearizer bias, Correction Factor 1 (release number 3 and later))".

[Operation complete](#)

### Calibration correction of communication channel settings

- 1** Tap **Communication channel settings** on the setting menu.  
The Communication channel settings screen appears.
- 2** Tap **Calibration correction**.  
The calibration correction settings are displayed.
- 3** Set the first channel and last channel.
- 4** If necessary, set the mode and the number of set points.
- 5** Set the calibration correction of each set point.
  - ▶ For details on settings, see page 1-179 in section 1.20.4, “Setting Calibration Correction (Linearizer approximation, linearizer bias, Correction Factor 1 (release number 4 (version 4.02) and later))”.

**Operation complete**

### 1.32.4 Displaying Reminders

All reminders that are currently valid are displayed.  
 The background color of each reminder varies depending on the elapsed time of the reminder.  
 The relation between the current time and the background color is as follows.

Current time	Background color setting	
	White	Black
	Background color	
Before the reminder date	White	Black
After the reminder date but before the due date	Yellow	Yellow
After the due date	Red	Red

#### Procedure

- 1 Press **MENU**.  
The menu screen appears.
- 2 Tap the **Browse** tab and then **Reminder**.  
The reminder screen appears.

#### Operation complete

The screenshot shows a grid of four reminders. The first reminder, 'Calibration reminder 1', has a red background and shows '0 days' until the due date. The second, 'Calibration reminder 2', has an orange background and shows '2 days'. The third, 'Calibration reminder 3', has an orange background and shows '3 days'. The fourth, 'Calibration reminder 4', has a white background and shows '4 days'. An arrow points from the first reminder to a 'Reminder information' screen. This screen displays: NO: 1, Title: Calibration reminder 1, Last setting date: 2015/10/29, Due date: 2015/10/29, and a 'Due date setting' button.

- Dates past the due date are displayed with negative numbers.
- Dates above 999 days are all shown as 999.

- Tap a reminder to display the reminder information screen.  
 Tap **Due date setting** to switch to the screen where you can set the due date and calibration correction.
- ▶ For details on Due date setting, see page 1-276 in section 1.32.3, "Resetting the Calibration Reminder Due Date, Performing Calibration Correction".

#### Operation complete

### 1.32.5 Limitation of Function (When the advanced security function (/AS) is enabled)

Limitation is placed on calibration reminder settings according to the user property calibration correction in the security settings.

The user limitations on the normal setting screen and due date setting screen are as follows.

Setting screen type	User limitation item		Details of limitation	
	Calibration correction	Setting operation	Setting screen	Calibration reminder setting Calibration correction in AI channel settings, PID control module, communication channel settings
Normal setting screen	Lock	Lock	Invalid	
		Free	Valid	Invalid
	Free	Lock	Valid	Valid
Due date setting screen	Lock	Free	Valid	
		Lock	Invalid	
	Free	Free	Invalid	
		Lock	Valid	Valid
		Free	Valid	Valid



## 1.33 Setting the Future Pen, Using the Future Alarm (Release number 4 (Version 4.08) and later)

The future pen setting does not appear when the measurement mode is high speed or dual interval, and when the advanced security function (/AS option) and multi-batch function (/BT option) are enabled.

### 1.33.1 Setting the Future Pen, Future Pen Channels

#### Path

GX/GP: **MENU** key > **Browse** tab > **Setting** > Setting menu **Future pen settings**

Web application: **Config.** tab > **Future pen settings**

Hardware configurator: **Future pen settings**

#### Future Pen Setting

##### Future pen

Setup Item	Selectable Range or Options	Default Value
On/Off	Off, On	Off

##### On/Off

Select **On** to use the future pen.

#### Future Pen Channels Setting

##### Future pen channels

Setup Item	Selectable Range or Options	Default Value
Channel set	Up to 10	–

##### Channel Set

Set the target channel for the future pen.

Select from IO channel, math channels (/MT option), and communication channels (/MC option).

In addition to tapping, you can swipe to set channels.

- ▶ Setting Channels through Swiping, refer to page 1-133 in section 1.12.2, “Configuring Recording Channels”.

### Future Pen Function

When an existing channel is set as the target channel (up to 10) for the future pen, that channel learns and predicts from past data, makes a prediction, and draws a predicted future waveform in the predicted future waveform area of the trend screen. The target channel of the future pen can detect the alarm from the predicted future waveform and generate the future alarm based on the alarm conditions (high and low limit, difference high and low limit when using delta) set for the existing channel. You can view future alarms on the future alarm summary screen. When a future alarm occurs, you can activate the event action function or send an email. You cannot draw predicted future waveforms in the web application. Only the future pen settings are available.

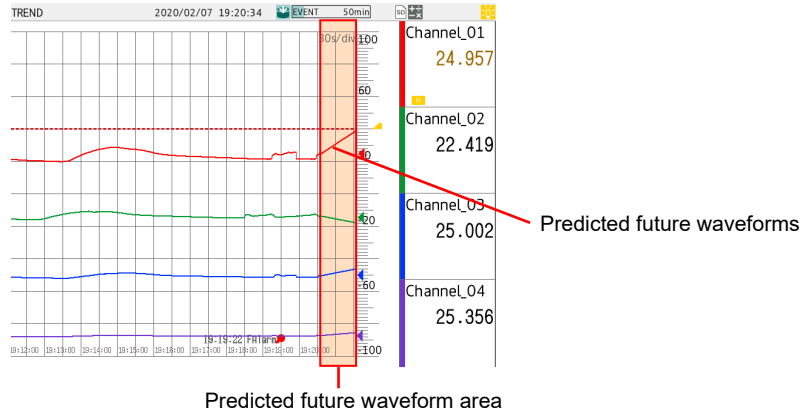

- For details of future pen, refer to page 2-41 in section 2.2.11, “Displaying Future Pen (Predicted future waveforms) (Release number 4 (Version 4.08) and later)”.

**Note** .....

Future waveforms predicted by the Future Pen function are for reference only. Performance, accuracy, and other properties are not guaranteed.

.....

## Future Pen Display Conditions

### Display Screen

The future pen appears on the trend screen. However, it does not appear on the following trend screens:

- Historical trend
- Trend parts of custom display function (/CG option)
- Trend screen of multi panel screen (GX20/GP20)

### Display Conditions

The display conditions of the future pen are as follows.

If the future pen does not appear, check the following settings and operating conditions:

Classification	Item		Condition	Description	
Initialize Calibration	Measurement mode		Normal		
	Option	Advanced security settings (/AS option)	Off		
		Multi batch (/BT option)	Off		
Settings	Setting menu	Setting item	Setting conditions	Description	
	AI channel settings	Range	Calculation	Other than Log input, Pseudo-log input, Linear- log input	
		Display settings	Group settings	Channel set	The target channel of the future pen is set to the display group.
	Trend interval		Trend interval [/div] (Recording interval)	30s(1s) to 10h(20min)	Data type is Display/ Display+Event
			Trend rate switching	Off	
	Recording settings	Recording channel settings		The target channel of the future pen is set as the recording channel.	
		Event	Recording interval	1 s to 30 min	Data type is Event
	Recording mode		Free		
Action	Recording		Recording in progress.		

### Note

- The future pen does not appear until a minimum of 30 data points have been collected for learning. (The hourglass icon (⌚) appears until the future pen appears.)
- If the power is cut off due to a power failure, the data for prediction is reset, and the future pen does not appear until a minimum of 30 data points are collected after recovery.

## 1.33.2 Using Future Alarm

When using the future pen function, detect\* the occurrence of an alarm based on the predicted future waveforms. The detection of the future alarm uses the alarm condition of the channel set in the future pen.

You can check the future alarm occurrence status on the future alarm summary screen. Using the information on the occurrence of a future alarm as a trigger, you can run an event action or send an email (future alarm mail).

\* The alarm setting of the channel set for the future pen is required.

▶ For details on the alarm settings, see the alarm settings for each channel.

### Alarm Conditions for Future Alarms

Valid alarm types for future alarms are H: High limit, L: Low limit, h: Difference high limit\*, l: Difference low limit\*.

\* For channels for which delta is set, only the difference high limit and difference low limit are enabled.

### Note

- Even if an output (relay, internal switch) is set to the alarm, a future alarm cannot be generated.
- Alarm hysteresis does not work for future alarms.
- Even if Logging is set to "Off" in the alarm settings, future alarms are logged.
- The future alarm is released when recording is stopped.

### Future Alarm Detection

Future alarm detection is run when the predicted future waveform is updated.

If the predicted future waveform does not appear, no future alarm is detected.

If the alarm settings are changed, the new settings will be applied from the next update.

If multiple future alarms occur on the same channel and at the same alarm level, the event closest to the current time is regarded as the future alarm, and is used for the future alarm summary display and the future alarm email send information.









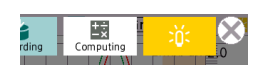

1.33 Setting the Future Pen, Using the Future Alarm (Release number 4 (Version 4.08) and later)

Future Alarm Display

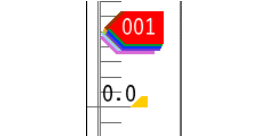
The following table shows the screens where the future alarm appears. If the current alarm and future alarm occur simultaneously, the current alarm appears with priority.

Note

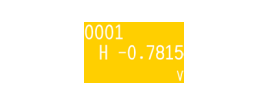
- The ACK function is not available for future alarms.
- The indicator holding operation cannot be performed for future alarms.
- If a future alarm occurs while the current alarm is being held, it blinks.
- The digital screen, bar graph screen, and custom display screen (/CG option) cannot display future alarms.

Screen type	Displayed location		Display	
			Lit display	Blinking display
Basic screen	Status display section	Main alarm icon		 Alternates
Menu screen (Dashbord menu)	Alarm ACK button			 Alternates
Trend screen	Scale	Alarm point mark		-
	Digital display	Alarm mark		 Alternates
Overview screen	Grouping			 Alternates
	Channel (within group)			 Alternates
	All channel			
Multi panel screen (GX20/GP20)	Trend screen		Same as full screen view	Same as full screen view
	Overview screen		Same as full screen view	Same as full screen view

Future Alarm Summary Display

The future alarm occurrence status is displayed as a list in the future alarm summary.

- ▶ For future alarm summary display, refer to page 2-67 in section 2.3.11, "Listing the Log of Future Alarm Occurrences (Future Alarm Summary) (Release number 4 (Version 4.08) and later)".

Sending email by future alarm

You can send an email triggered by the occurrence/release\* of a future alarm. Set the future alarm mail in the alarm settings of the email setting (common to the current alarm).

Future alarm mails are sent as separate emails from normal alarm notification emails.

\* If recording is stopped while a future alarm is occurring, a release email is not sent.

- ▶ For E-mail, refer to page 1-187 in section 1.21.4, "Setting E-mail Transmission Conditions (When the SMTP client function is on)".

### **1.33 Setting the Future Pen, Using the Future Alarm (Release number 4 (Version 4.08) and later)**

---

#### **Event Action by Future Alarm**

The specified action can be run with the occurrence of the future alarm as the event (any future alarm).

- ▶ For event action, refer to page 1-162 in section 1.19, “Configuring the Event Action Function”.

# 2.1 Starting and Stopping Recording and Computation

This section explains how to start recording and computation.

## 2.1.1 Starting and Stopping Recording

Start and stop recording.

When the measurement mode is Dual interval, measurement groups also start or stop recording.

### Procedure

#### Starting Recording

► For the procedure when the batch function is in use, see page 2-4 in section 2.1.2, “Using the Batch Function”.

- 1 Press **MENU**.  
The menu screen appears.

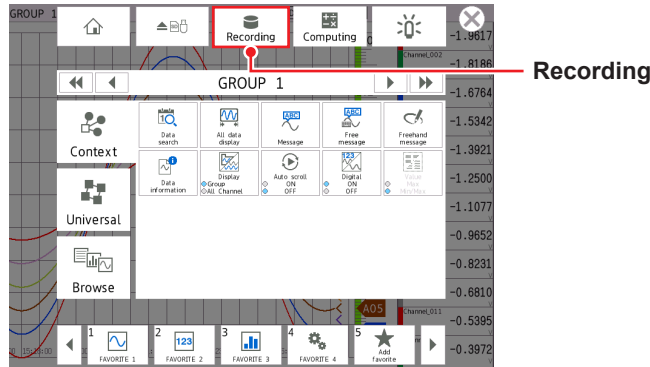

- 2 Tap **Recording**.  
The record start screen appears.

- 3 Tap **Rec+Math**, **Rec+Math (Math reset)**, or **Record**.  
Recording starts. The recording status icon in the status display section changes from stopped to started.

On models with the math option (/MT option), you can select **Rec+Math**. Computation starts when recording starts.

Record: Only recording starts.

Rec+Math: Recording and computation start at the same time.

Rec+Math (Math reset): Computation is reset and then recording and computation start at the same time.



On models with the program control (/PG) option, refer to the explanation in page 1-40 in section 1.2.3, “Setting the Display”.

Operation complete

- You can also use the **START/STOP** key. However, whether the record start screen appears or the recording starts immediately will depend on the Record confirmation action (release number 2 and later) setting.
  - ▶ For details on the settings, see page 1-125 in section 1.12.1, “Setting the Type of Data to Record (Display or event data) and Recording Conditions”.To also start computing, in the math channel settings, you need to set **START/STOP key action** to **Start / Stop** or **Reset + Start / Stop**.
  - ▶ For details on the settings, see page 1-83 in section 1.8.1, “Setting Basic Computation Operations (Error indications, operation at start, overflow handling, PSUM overflow 1 handling)”.
- If you are recording display or event data in free run mode, the GX/GP starts recording when you start recording. If you are recording event data in trigger mode, the GX/GP enters the trigger-wait state. Digital values are updated, but waveform data will not appear until a trigger occurs. For instructions on how to display waveforms, see the reference below.
  - ▶ For the procedure to apply record start triggers, see page 2-6 in section 2.1.3, “Applying a Record Start Trigger for Event Data”.
- ▶ For starting and stopping recording using event actions, see page 1-162 in section 1.19, “Configuring the Event Action Function”.

### Stopping Recording

- ▶ For the procedure when the batch function is in use, see page 2-4 in section 2.1.2, “Using the Batch Function”.

- 1** Press **MENU**.  
The menu screen appears.
- 2** Tap **Record**.  
The record stop screen appears.
- 3** Tap **Rec+Math** or **Record**.  
Recording stops. The recording status icon indicates stopped.

When computation (/MT option) is in progress, you can select **Rec+Math**. Computation stops when recording stops.

#### Operation complete

- You can also use the **START/STOP** key. However, whether the record stop screen appears or the recording stops immediately will depend on the Record confirmation action setting.
- If **START/STOP key action** in the math channel settings is set to **Start / Stop** or **Reset + Start / Stop**, computation also stops when you press the **START/STOP** key.



**Explanation****Operations That Start When Recording Starts**

- Waveform display updating on the trend display
- Reporting (/MT option)
- Computation (/MT option; when **START/STOP key action** is set to **Start / Stop** or **Reset + Start / Stop**)

**Operations That Stop When Recording Stops**

- Waveform display updating on the trend display
- Reporting (/MT option)
- Computation (/MT option; depends on the setting specified in the procedure above)

**Performance While Data Is Being Saved**

If the internal memory or external storage medium is continuously accessed, the following phenomena may occur. When such phenomena occur, the storage medium access indicator frequently illuminates.

- Files being saved to the external storage medium drop out.
  - Accessing the GX/GP through communication takes a long time.
- If these conditions occur, take the following measures.
- If you are creating data files at short intervals consecutively using the event action function, increase the data file save interval.
  - If you are creating numerous files in a single directory on the external storage medium, change the destination directory name at approximately every 1000 files.
  - If data recording and display are using up resources (for example if you are recording on multiple channels at a fast rate and displaying trend displays on all the multi panels), reduce the recording interval, or change the display.

**Recording Start/Stop When the Measurement Mode Is Set to High speed or Dual Interval**

When the scan interval is shorter than 100 ms, the processing of recording start/stop is performed at 100 ms intervals.

## 2.1.2 Using the Batch Function

### Procedure

#### Setting the Batch Name (Batch name-No. Lot No.) and Comments

- 1 Press **MENU**.  
The menu screen appears.
- 2 Tap the **Universal** tab and then **Batch**.  
A screen for setting the batch name and comments appears.
- 3 Tap **Batch name-No.**, and set the batch number. (Up to 32 characters)  
If you are using lot numbers, set the lot number.
- 4 Tap **Comment 1**, **Comment 2**, or **Comment 3**, and enter the comment. (Up to 50 characters)
- 5 Tap **Exit**.  
The batch screen closes.

#### Operation complete

#### Note

- Batch numbers and lot numbers cannot be changed after the GX/GP starts recording.
- You can change the comments as many times as you wish before the GX/GP starts recording. The last specified comment is valid. After the GX/GP starts recording, you can only set comments in empty comment boxes. However, comments that you have confirmed cannot be changed.
- The comments are cleared when the GX/GP stops recording.
- The text fields that you set before you start recording (see "Starting Recording (Record start)" on the next page) are cleared when the GX/GP stops recording.
- The batch number, lot number, and comments are saved to the display data file or event data file. They are not saved to the setting parameter file.

#### Displaying the Text Field Settings

- 1 Press **MENU**.  
The menu screen appears.
- 2 Tap the **Universal** tab and then **Text field**.  
The batch text field settings appear.

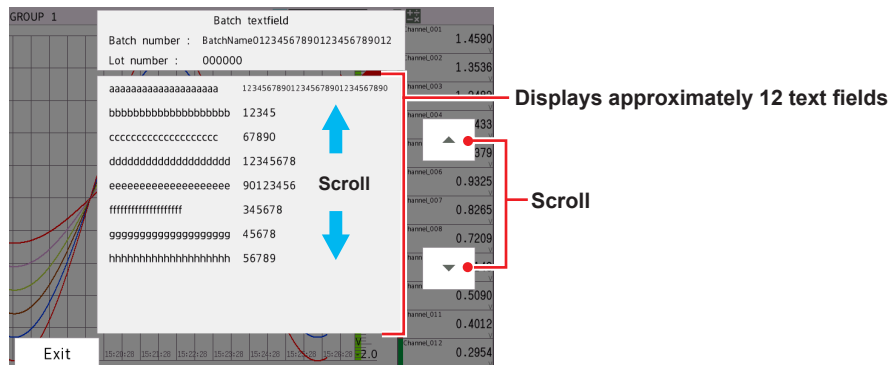

You can drag or flick to scroll through the batch text field.

- 3 Tap **Exit**.  
The screen closes.

#### Operation complete

## Starting Recording

- 1 Press **MENU**.  
The menu screen appears.
- 2 Tap **Recording**.  
The record start screen appears.
- 3 Tap **Batch name-No.** and **Lot No.**, and set each item.
- 4 If necessary, tap **Batch text field (text)** or **Batch comment** to set them.  
Tap **Edit textfield** or **Edit comment** to display Batch textfield or Batch comment in the Record start screen.  
The text fields that you specify here will only be saved to the measurement data file that you are about to start recording to. The text fields that you have set from the setting menu will not change.

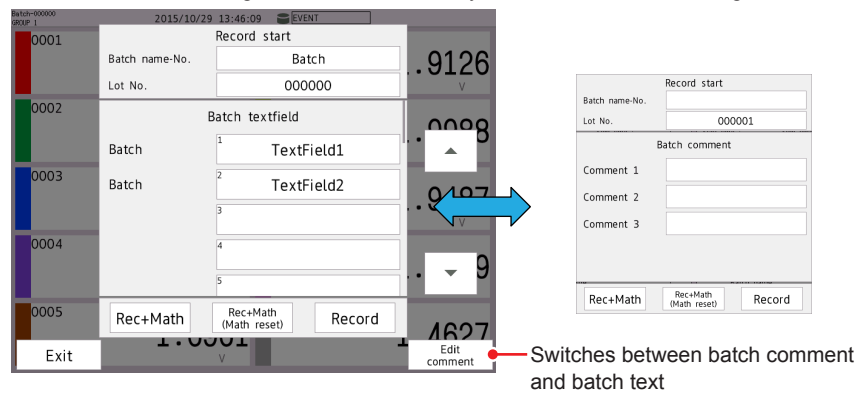

- 5 Tap **Rec+Math**, **Rec+Math (Math reset)**, or **Record**.  
Recording starts. The recording status icon in the status display section changes from stopped to started.  
If computation is not in progress, you can select **Rec+Math** or **Rec+Math (Math reset)**.  
On Models without the math function (/MT option), tap **Start**.

### Operation complete

- You can also use the **START/STOP** key.
  - ▶ For details, see page 2-1 in section 2.1.1, "Starting and Stopping Recording".

- If you are recording display or event data in free run mode, the GX/GP start recording when you start recording. If you are recording event data in trigger mode, the GX/GP enters the trigger-wait state.
  - ▶ For the procedure to apply a record start trigger, see page 2-6 in section 2.1.3, “Applying a Record Start Trigger for Event Data”.
- ▶ For starting and stopping recording using event action, see page 1-162 in section 1.19, “Configuring the Event Action Function”.

### Stopping Recording

- 1** Press **MENU**.  
The menu screen appears.
- 2** Tap **Record**.  
The record stop screen appears.
- 3** Tap **Rec+Math** or **Record**.  
Recording stops.

When computation (/MT option) is in progress, you can select **Rec+Math**. Computation stops when recording stops.

On Models without the math function (/MT option), tap **Stop**.

- 4** Tap the **Exit** icon to close the menu screen.

#### Operation complete

- You can also use the **START/STOP** key. If you use this key, recording will stop immediately.
- If **START/STOP key action** in the math channel settings is set to **Start / Stop** or **Reset + Start / Stop**, computation also stops when you press the **START/STOP** key.

### 2.1.3 Applying a Record Start Trigger for Event Data

The procedure below can be carried out when recording event data in trigger mode and the GX/GP is configured so that the start trigger is applied through trigger source operation. In **Recording settings**, under **Basic settings**, event data **Trigger source operation** must be set to **On**.

- ▶ For details on the settings, see page 1-125 in section 1.12.1, “Setting the Type of Data to Record (Display or event data) and Recording Conditions”.

#### Procedure

##### Triggering through Trigger Source Operation

Carry out the following procedure when the GX/GP is in the trigger-wait state.

- 1** Press **MENU**.  
The menu screen appears.
- 2** Tap the **Universal** tab.
- 3** Tap **Event trigger**.  
Recording starts.

When the measurement mode is set to **Dual interval**

A screen for selecting the measurement group that triggers will be applied to appears. Tap the scan group that triggers will be applied to. To apply triggers to both scan groups, tap **ALL**.

#### Operation complete

**Triggering Based on Events (Event action function must be configured.)**

Recording starts when an event occurs.

- ▶ For setting the event action function, see page 1-162 in section 1.19, “Configuring the Event Action Function”.

**Note**

- If the file type of the recording mode is **Event**, the trend interval will correspond to the recording interval of event data.
- If the recording mode of event data is set to trigger in basic settings under recording settings, digital values will be updated, but waveform data will not be displayed until a trigger occurs. To display waveform data, set Trend rate switching under Display settings to **On**.

**2.1.4 Starting, Stopping, and Resetting Computation****Procedure****Starting Computation**• **Starting Computation When Recording Starts**

- ▶ See page 2-1 in section 2.1.1, “Starting and Stopping Recording”.

• **Starting Only the Computation**

- 1 Press **MENU**.  
The menu screen appears.

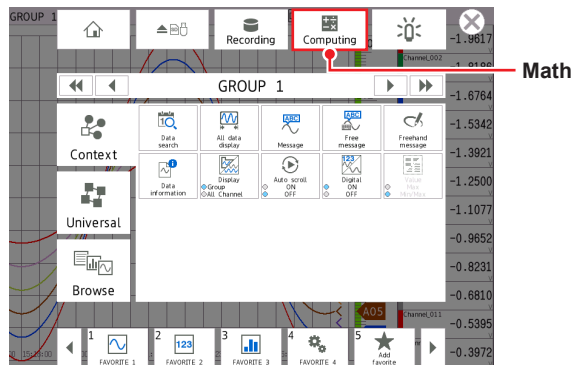

- 2 Tap **Computing**.  
The Start math computations screen appears.

- 3 Tap **Start**.  
Computation starts. The math icon is displayed in the status display section.



**Operation complete**

### Stopping Computation

- **Stopping Computation When Recording Stops**

- 1** Press **MENU**.  
The menu screen appears.
- 2** Tap **Recording**.  
The record stop screen appears.
- 3** Tap **Rec+Math**.  
Recording and computation stops, and the math icon in the status display section disappears.
- 4** Tap the **Close** icon to close the menu screen.

Operation complete

- **Stopping Only the Computation**

- 1** Press **MENU**.  
The menu screen appears.
- 2** Tap **Computing**.  
The Stop math computations screen appears.
- 3** Tap **Stop**.  
Computation stops, and the math icon in the status display section disappears.

Operation complete

#### **Note**

When you stop computation, the computed value for math channels is set to the value held immediately prior to computation stopping. When recording, this retained value is recorded.

### Resetting the Computed Results on All Math Channels

You can carry out this procedure when computation is stopped and when computation is in progress.

- 1** Press **MENU**.  
The menu screen appears.
- 2** Tap **Computing**.  
The Start math computations or Stop math computations screen appears.
- 3** Tap **Reset**.  
The computation is reset.

Operation complete

## 2.1.5 Clearing Computation Data Dropout Displays

You can carry out this procedure when a computation data dropout occurs. When a computation data dropout occurs, the math icon turns yellow.

### Procedure

- 1** Press **MENU**.  
The menu screen appears.
- 2** Tap **Computing**.  
The computation operation screen appears.
- 3** Tap **ACK**.  
The math icon turns gray.

**ACK** on the computation operation screen is valid only when a computation data dropout occurs.

### Operation complete

### **Note**

//////  
A computation data dropout occurs if the computation is not completed within the scan interval. If computation data dropout occurs frequently, reduce the load on the CPU by reducing the number of math channels or setting a longer scan interval. When a computation data dropout occurs during recording, the computed data of the scan interval in which the dropout occurred is set to the data immediately before the dropout.  
//////

## 2.2 Configuration of Measured Data Display

This section explains how to display various measured data.

### 2.2.1 Displaying Measured Data Using Waveforms, Numeric Values, Bar Graph, or Custom Display (ICG option) (Trend, digital, bar graph, and custom displays)

#### Procedure

#### Displaying the Trend, Digital, or Bar Graph Display

- 1 Press **MENU**.  
The menu screen appears.
- 2 Tap the **Browse** tab.

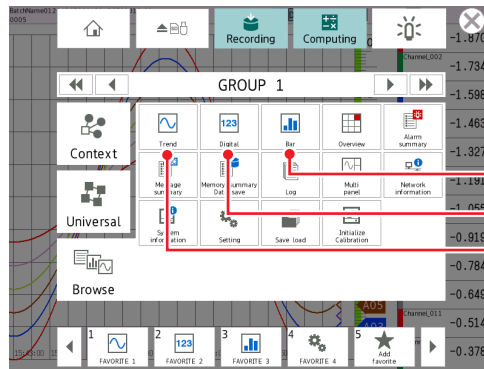

Bar graph display  
Digital display  
Trend display

- 3 Tap **Trend**, **Digital**, or **Bar graph**.  
The display that you selected appears.

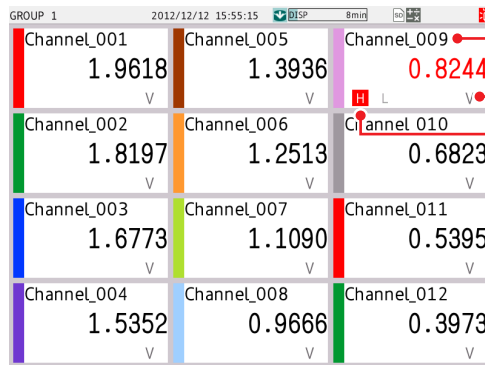

Channel number or tag

Unit

Alarm mark

H No alarms; all acknowledged

H ↔ H No alarms; some not acknowledged

H Alarms present; all acknowledged

H ↔ H Alarms present; some not acknowledged

Blinking

GX20 digital display example

#### Precedence in Displaying Tags (Characters and numbers)

Tag numbers are displayed with higher precedence than tag characters.

When tag numbers are not assigned, tag characters are displayed.

If neither the tag numbers nor tag characters are assigned, channel numbers are displayed.

#### Maximum Number of Channels That Can Be Displayed in a Group

GX20/GP20: 20 channels

GX10/GP10: 10 channels

Operation complete



### Showing the Custom Display (Release number 2 and later)

The procedure below is performed after loading a custom display.

- ▶ For the procedure to load a custom display, see page 1-234 in section 1.25.5, “Loading and Deleting Custom Displays (/CG option) (Release number 2 and later)”.

**1** Press **MENU**.  
The menu screen appears.

**2** Tap the **Browse** tab and then **Custom display**.

#### If the display is the first one shown

Of the custom displays that have been assigned, the one with the smallest display number is shown.

#### If the currently shown display is not a custom display

The custom display whose display number was shown previously is shown.

#### If the currently shown display is a custom display

The Custom Display Selection screen appears.

**3** Tap the custom display (display number) you want to show.  
The custom display appears.

#### Operation complete

### Using the Custom Display (Release number 2 and later)

The procedure below is performed after loading a custom display.

Use a custom display consisting of components with action functions (button operation, DOIntSwitch, digital operation).

- ▶ For details on creating custom displays and details on components with action functions, see the DAQStudio manual (IM04L41B01-62EN).

Example of a custom display consisting of components with action functions

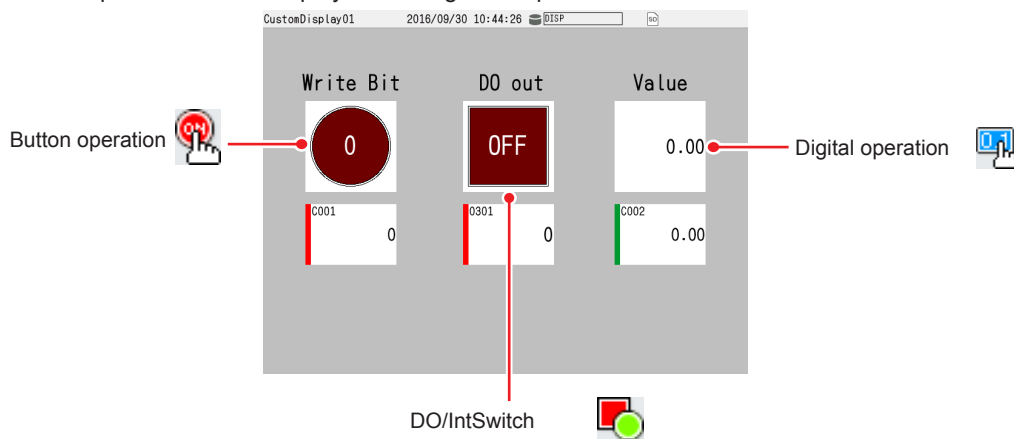

### Button Operation Example

Write bit-inverted values in communication channel C001.

- 1 Tap the button operation component.  
A button operation screen appears.

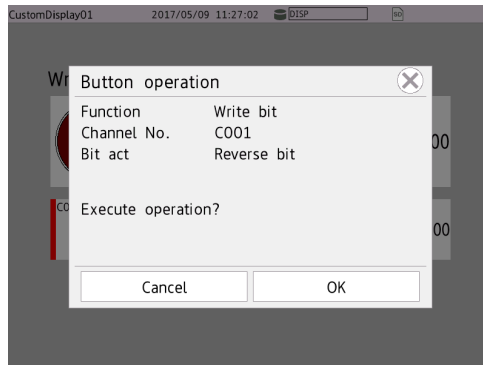

- 2 Tap **OK**.  
The bit is written.  
Each time you use the component, an inverted bit is written.  
If the component's Confirm dialog property is set to Off, the bit is written when the component is tapped.

#### Operation complete

### DO/IntSwitch

The DO is turned on and off through DO output operation.

In **Display settings**, under **Screen display settings**, Changing each value from monitoring **On/Off** must be set to **On**.

- 1 Tap the DO/internal switch component.  
The channel information (DO) appears.

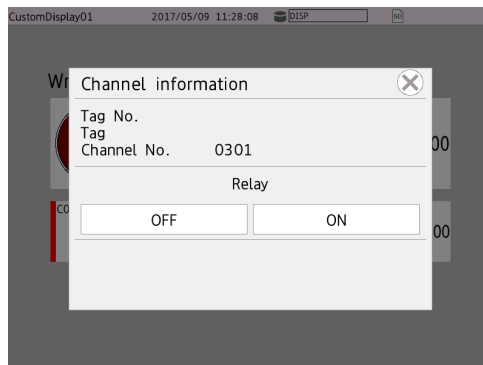

- 2 Tap **On** or **Off**.  
The DO/internal switch is set to the state you tapped.  
If the component's Confirm dialog property is set to Off, the bit is written when the component is tapped.

#### Operation complete

### Digital Operation

Example in which a value is written to communication channel C002

- 1 Tap the numeric operation component.  
An input screen appears.

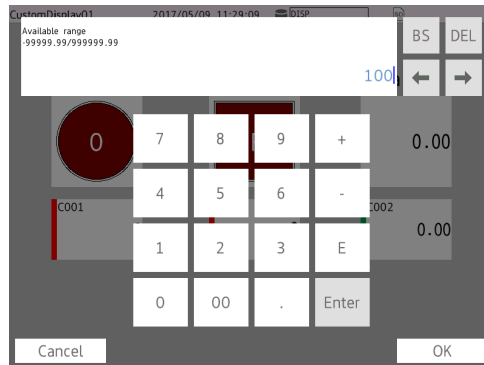

- 2 Set a value.  
The value is written.

### Displaying Channel Information

The tag number, tag, channel number, alarm level, DO output state, and output state (retransmission output) or output value (manual output) of the selected channel are displayed.

You can carry out this procedure on the trend, digital, bar graph, overview, report screen (/MT), and custom display (/CG).

- 1 Tap the channel data digital display section to display the information about the selected channel. On the trend display, double-tap the digital display section.  
The channel information screen appears.

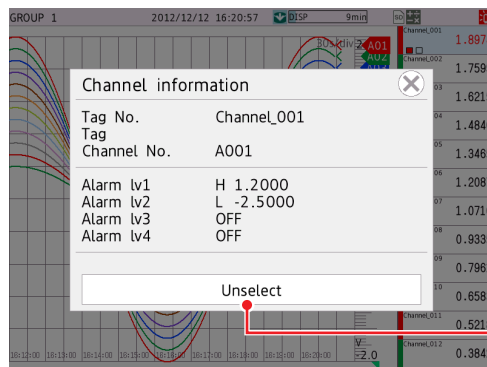

**Trend display**  
Returns the waveform displayed on top to the original condition.

On the trend display, tapping the digital display section once shows the tapped waveform on the top.

- 2 Tap the **Close** icon.  
The channel information screen closes.

**Operation complete**

### Changing Alarm Values from the Monitor

You can carry out this procedure on the trend, digital, bar graph, and overview displays. This procedure is applicable to channels that have alarms assigned to them.

In **Display settings**, under **Screen display settings**, Setting **Changing each value from monitoring On/Off** must be set to **On**.

- 1 Tap a channel that has alarms assigned to it. The channel information screen appears.

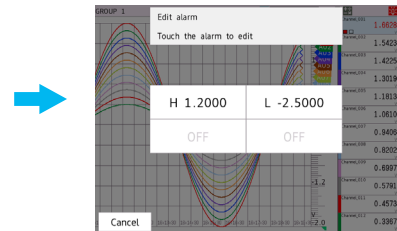
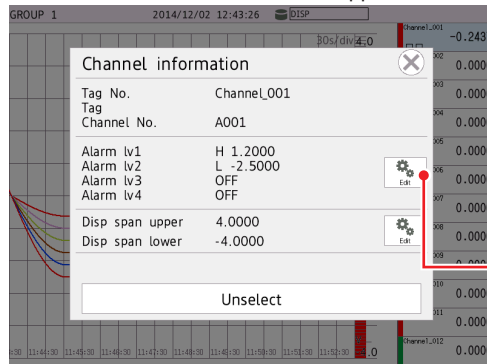

Edit alarm values.

- 2 Tap **Edit alarm**. The alarm edit screen appears.
- 3 Tap the alarm level you want to edit. A keyboard will appear.
- 4 Set the alarm value, and tap **OK**. The new alarm value is applied.

Operation complete

### Changing Display Span Values from the Monitor

You can carry out this procedure on the trend display. For channels whose display span cannot be changed, this procedure is not possible.

- 1 Tap the channel you want to change the display span of. The channel information screen appears.

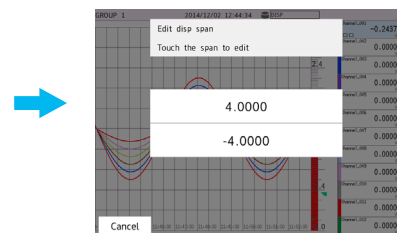
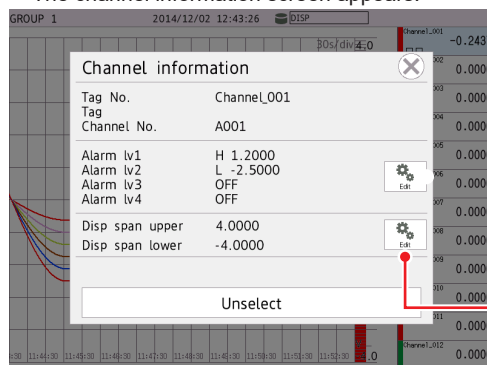

Edit display span

- 2 Tap **Edit** of display span. The display span edit screen appears.
- 3 Tap the display span upper or lower limit you want to edit. A keyboard will appear.
- 4 Set the display span value, and tap **OK**. The new display span value is applied.

Operation complete

**Note**

If you change from the monitor, the display span value of only the selected channel will be changed.

**DO Channel Operation from the Monitor**

This procedure is for when, in the DO channel range settings, type is set to **Manual**. In the Display settings, under Screen display settings, Changing each value from monitoring must be set to On. For the setting procedure, see page 1-117 in section 1.10.5, "Setting Basic Screen Items".

- 1 Tap a DO channel.  
The channel information appears.

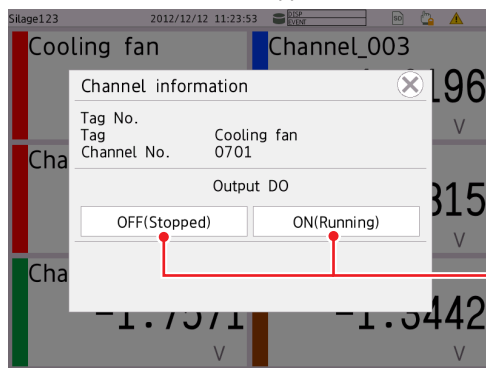

"ON" or "OFF"  
The specified character string is shown in parentheses.

- 2 Tap **ON** or **OFF**.  
The tapped value (ON or OFF) takes effect.
- 3 Tap the **Close** icon to close the channel information screen.

**Operation complete****Individual AO Channel Operation from the Monitor**

From the monitor, you can individually operate the AO channel assigned to retransmission output or manual output.

Retransmission output: Turn on and off the retransmission output.

Manual output: Set the output value.

You can carry out this procedure on the trend, digital, bar graph, overview, and custom displays.

In **Display settings**, under **Screen display settings**, **Changing each value from monitoring** must be set to **On**.

► See page 1-117 in section 1.10.5, "Setting Basic Screen Items".

Users whose **Output operation** under User property in the security settings is set to **LOCK** cannot operate AO channels.

If **Output operation** under User property in the security settings is set to **LOCK**, AO channel operation is not possible while the operation is locked.

### Turning Retransmission Output On or Off

- 1 Tap an AO channel.  
The channel information screen appears.

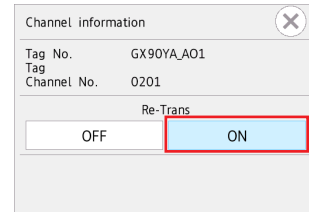
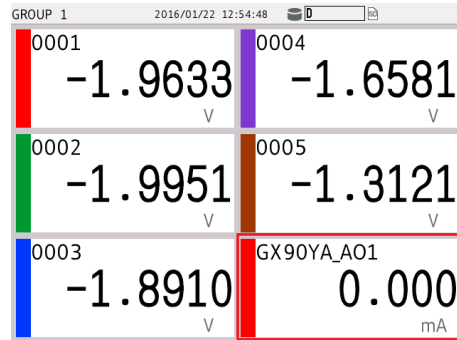

The highlighted one is the current state.

- 2 Tap **ON** or **OFF**.  
The tapped value (**ON** or **OFF**) takes effect.

Operation complete

### Performing Manual Output

- 1 Tap an AO channel.  
The channel information screen appears.
- 2 Tap the displayed output value.  
A keyboard appears.

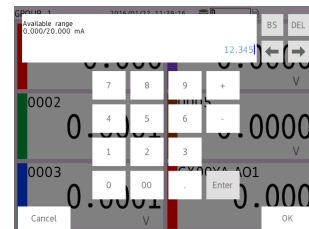
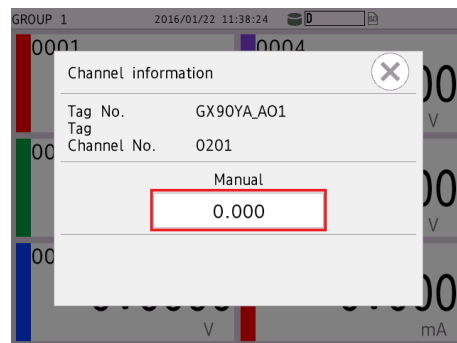

- 3 Set the output value, and tap **OK**.  
The specified value is output.

Operation complete

### Collective AO Channel Operation from the Monitor

You can turn on and off the AO channels assigned- to retransmission output at once. Users whose **Output operation** under **User property** in the security settings is set to **LOCK** cannot operate AO channels.

If **Output operation** under User property in the security settings is set to **LOCK**, AO channel operation is not possible while the operation is locked.

### Turning Retransmission Output On or Off at Once

- 1 Press **MENU**, and tap the **Universal** tab and then **All re-trans ON/OFF**. The All re-transmission ON/OFF screen appears.

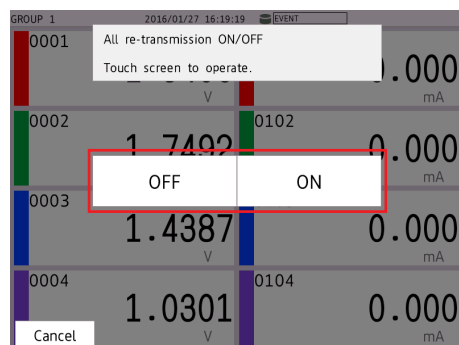

- 2 Tap **ON** or **OFF**. The tapped value (**ON** or **OFF**) takes effect on all AO channels whose range is set to **Re-Trans**.

Operation complete

### Starting the Waveform Display of the Trend Display and Stopping the Waveform Updating

When recording starts, the waveform display on the trend display starts. When recording stops, waveform updating stops.

### Showing the Trend Display in the Group Display and Showing All Channels

In the group display, the waveforms of the channels that are registered to the group are displayed.

In all channel display, the waveforms of all channels that are configured to record data are displayed on the current group display. The waveforms of channels that are not assigned to the group are displayed in the waveform display area, but the scales, current value marks, and digital values of the channels are not displayed.

All channel display is not possible when the trend interval is less than 30 s/div.

If the measurement mode is set to dual interval, only the recording channels assigned to the displayed measurement group are displayed. (Channels of the other measurement group are not displayed.)

If you want to display different measurement groups on a single screen, use the multi panel screen or custom display.

Number of displayable channels

GX20/GP20: 100 channels

GX10/GP10: 30 channels

- 1 Press **MENU**. The menu screen appears.
- 2 Tap the **Context** tab and then **Display Group/All Channel**. The display switches.

Each time you tap **Display Group/All Channel**, the setting toggles between group and all channel.

- 3 Tap the **Close** icon to close the menu screen.

Operation complete

### Changing Where the Digital Display Appears on the Trend Display

The digital display on the trend display can be shown in any of the four edges of the screen. Drag the digital display section to the top, bottom, left, or right edge.

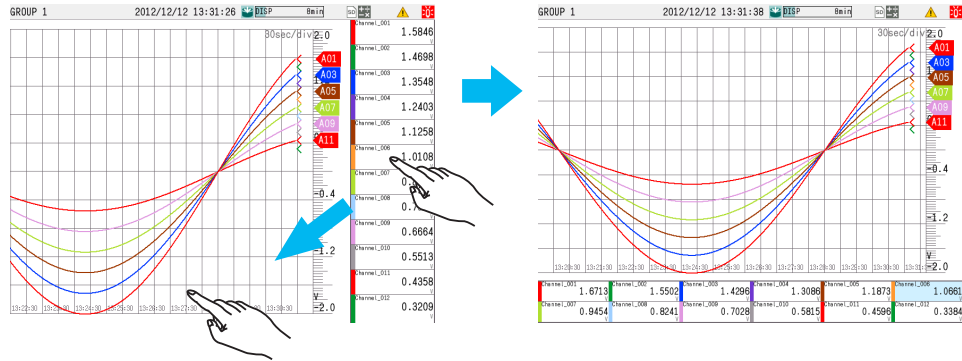

### Showing or Hiding the Digital Display on the Trend Display

Select whether to show or hide the digital display section.

- 1 Press **MENU**.  
The menu screen appears.
- 2 Tap the **Context** tab and then **Digital ON OFF**.  
The digital display section is shown or hidden.  
Each time you tap **Digital ON OFF**, the setting toggles between shown and hidden.
- 3 Tap the **Close** icon to close the menu screen.

Operation complete

### Switching the Digital Display between Characters and Digit (When display character of each value is set)

- 1 Press **MENU**.  
The menu screen appears.
- 2 Tap the **Universal** tab and then **Digital label Character/Digit**.  
The digital display section is character or digit.

Each time you tap **Digital label Character/Digit**, the setting toggles between character and digit.

If display character of each value is not set, numbers (digits) will be displayed even if you change the digital display to characters.

- 3 Tap the **Close** icon to close the menu screen.

Operation complete

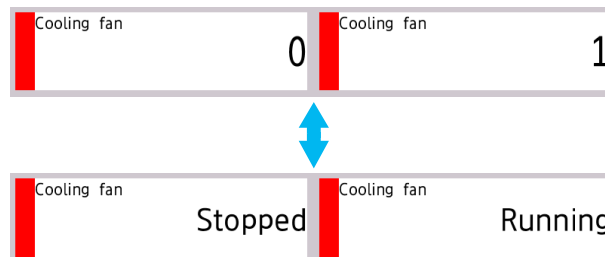



### Turning On or Off the Fine Grid Display of the Trend Display (Release number 3 and later)

Select whether to show or hide the fine grid.

- 1 Press **MENU**.  
The menu screen appears.
- 2 Tap the **Context** tab and then **Fine Grid ON/OFF**.  
The fine grid is shown or hidden.

Each time you tap **Fine Grid ON/OFF**, the setting toggles between show and hide.

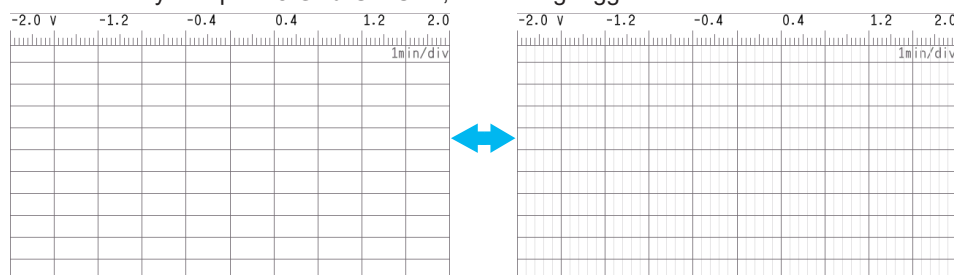

Auxiliary grid display

The number of fine grid lines vary depending on the model.

- GX20/GP20: 9 lines between basic grid lines
- GX10/GP10: 4 lines between basic grid lines

- 3 Tap the **Close** icon to close the menu screen.

**Operation complete**

## 2.2.2 Switching the Group to Display

You can carry out this procedure on the trend, digital, bar graph, and historical trend displays.

### Procedure

#### Switching the Group Using the Group Switch Icons

- 1 Press **MENU**.  
The menu screen appears.
- 2 Tap the group switch icons to switch the displayed group.  
The group that you selected appears.

Goes back 1 group      Advances 1 group  
Goes back 10 groups      Advances 10 groups

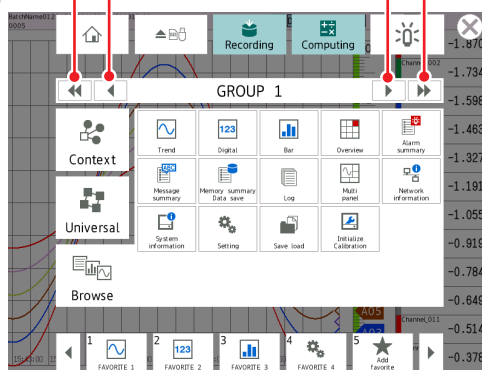

- 3 Tap the **Close** icon to close the menu screen.

**Operation complete**

### Switching the Group by Flicking

#### Digital, Bar Graph, or Multi Panel Display

- Advance 1 group: Flick the screen left  
Flick the screen up
- Go back 1 group: Flick the screen right  
Flick the screen down

#### Trend Display

- Direction is Horizontal
- Advance 1 group: Flick the screen up
- Go back 1 group: Flick the screen down
- Direction is Vertical
- Advance 1 group: Flick the screen left
- Go back 1 group: Flick the screen right

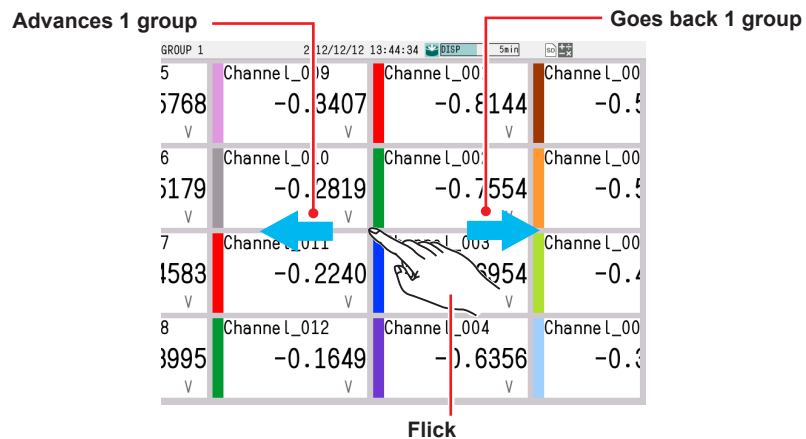

### Enabling or Disabling Auto Switching

If you set auto scroll to On, groups can be automatically switched at the specified interval. The display switches in ascending order by group number: Group 1, 2, 3, and so on. You can set the interval by setting monitor **Scroll time** under **Screen display settings** in **Display Settings**.

- 1 Press **MENU**.  
The menu screen appears.
- 2 Tap the **Context** tab and then **Auto scroll ON/OFF**.  
Auto switching of groups is turned on or off.

Each time you tap **Auto scroll ON/OFF**, the setting toggles between ON and OFF.

Operation complete

### 2.2.3 Displaying the Statuses of All Channels on One Screen (Overview Display)

This section explains how to use the overview display.

**Procedure**

**Displaying the Overview**

- 1 Press **MENU**.  
The menu screen appears.
- 2 Tap the **Browse** tab and then **Overview**.  
The overview is displayed.

Channel	Value	Unit	Channel	Value	Unit	Channel	Value	Unit	Channel	Value	Unit
Channel_001	1.9480	0.5357	Channel_011	1.8480	0.5357	Channel_021	1.8480	0.5357	Channel_031	1.8480	0.5357
Channel_002	1.8088	0.3845	Channel_012	1.8088	0.3845	Channel_022	1.8088	0.3845	Channel_032	1.8088	0.3845
Channel_003	1.6655	0	Channel_013	1.6655	0	Channel_023	1.6655	0	Channel_033	1.6655	0
Channel_004	1.5243	0	Channel_014	1.5243	0	Channel_024	1.5243	0	Channel_034	1.5243	0
Channel_005	1.3811	1.6655	Channel_015	1.3811	1.6655	Channel_025	1.3811	1.6655	Channel_035	1.3811	1.6655
Channel_006	1.2419	1.5243	Channel_016	1.2419	1.5243	Channel_026	1.2419	1.5243	Channel_036	1.2419	1.5243
Channel_007	1.1095	1.3811	Channel_017	1.1095	1.3811	Channel_027	1.1095	1.3811	Channel_037	1.1095	1.3811
Channel_008	0.9594	1.2419	Channel_018	0.9594	1.2419	Channel_028	0.9594	1.2419	Channel_038	0.9594	1.2419
Channel_009	0.8182	1.1095	Channel_019	0.8182	1.1095	Channel_029	0.8182	1.1095	Channel_039	0.8182	1.1095
Channel_010	0.6789	0.9594	Channel_020	0.6789	0.9594	Channel_040	0.6789	0.9594	Channel_050	0.6789	0.9594
Channel_051	0.5357	1.8480	Channel_061	0.5357	1.8480	Channel_071	0.5357	1.8480	Channel_081	0.5357	1.8480
Channel_052	0.3845	1.8088	Channel_062	0.3845	1.8088	Channel_072	0.3845	1.8088	Channel_082	0.3845	1.8088
Channel_053	0	1.6655	Channel_063	0	1.6655	Channel_073	1.8480	0.5357	Channel_083	0	1.6655
Channel_054	0	1.5243	Channel_064	0	1.5243	Channel_074	0	1.5243	Channel_084	0	1.5243
Channel_055	1.6655	1.3811	Channel_065	1.6655	1.3811	Channel_075	1.6655	1.3811	Channel_085	1.6655	1.3811
Channel_056	1.5243	1.2419	Channel_066	1.5243	1.2419	Channel_076	1.5243	1.2419	Channel_086	1.5243	1.2419
Channel_057	1.3811	1.1095	Channel_067	1.3811	1.1095	Channel_077	1.3811	1.1095	Channel_087	1.3811	1.1095
Channel_058	1.2419	0.9594	Channel_068	1.2419	0.9594	Channel_078	1.2419	0.9594	Channel_088	1.2419	0.9594
Channel_059	1.1095	0.8182	Channel_069	1.1095	0.8182	Channel_079	1.1095	0.8182	Channel_089	1.1095	0.8182
Channel_060	0.9594	0.6789	Channel_070	0.9594	0.6789	Channel_080	0.9594	0.6789	Channel_090	0.9594	0.6789

- Channel number, tag, or tag No.
- Measured value and unit
- Channels on which alarms are occurring are displayed in red.

All channel overview display

- ▶ For details on alarm status, see “section , “Overview Monitor” in section 3.1.4, “Monitoring the GX/GP Data and Controlling the GX/GP from the Monitor Screen.”

**Operation complete**

**Note**

If the number of used channels (the total of IO channels, math channels, and communication channels) exceeds the maximum number of the overview display (30 for the GX10/GP10 and 100 for the GX20/GP20), all channel display is not possible.

### Displaying the Channel Overview and Group Overview

- 1 Press **MENU**.  
The menu screen appears.
- 2 Tap the **Context** tab and then **Display Grouping/All channel**.  
Either the overview at the channel level or the overview at the group level is displayed.

Each time you tap **Display Grouping/All channel**, the setting toggles between displaying at the channel level and group level.

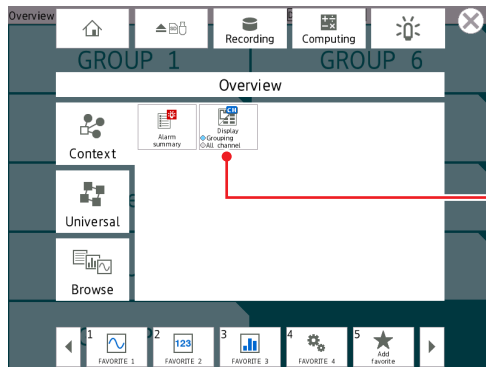

- Switch between groups and all channels

- 3 Tap the **Close** icon to close the menu screen.

Operation complete

**Displaying the Channel Overview of a Group in the Displayed Group Overview**

- 1 Tap a group.  
The channel overview of the group appears.

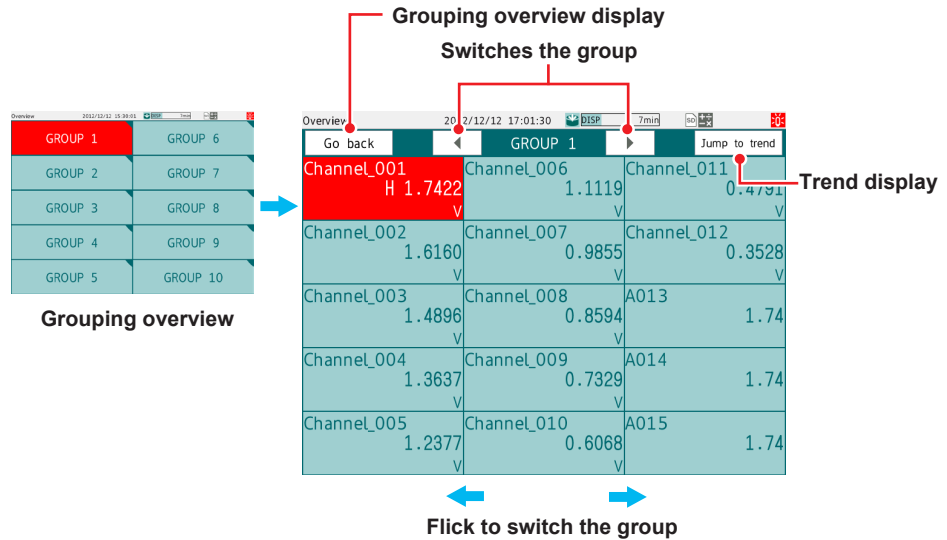

You can switch the group using the group switch icons.  
Tap **Jump to trend** to show the trend display.

- 2 Tap **Go back** to return to the group overview display.

Operation complete

**Showing the Trend That Includes the Specified Channel**

You can carry out this procedure on the channel overview display.  
For the procedure on the group overview display, see the previous section.

- 1 Tap a channel.  
The channel information screen appears.

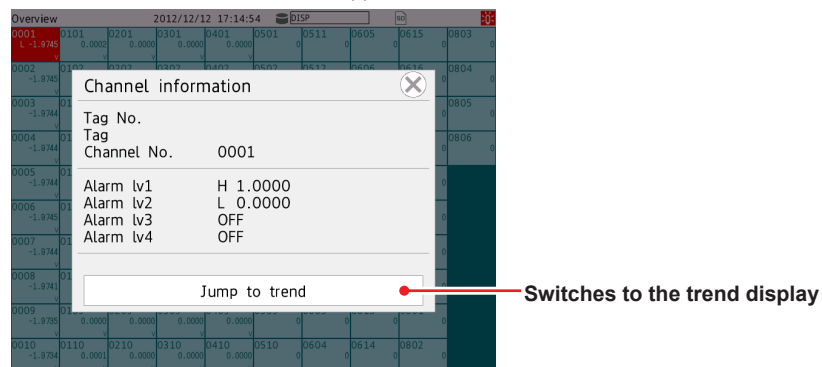

- 2 Tap **Jump to trend**.  
The trend display appears.

Operation complete

## 2.2.4 Displaying the Multi Panel (GX20/GP20 only)

You can divide the screen into several areas and assign the displays of your choosing to the areas.

There are nine display division patterns available.

You can set up to 20 multi panels.

### Procedure

#### Displaying the Multi Panel

- 1 Press **MENU**.  
The menu screen appears.
- 2 Tap the **Browse** tab and then **Multi panel**.  
The multi panel appears.

Operation complete

#### Switching the Multi Panel

- 1 Press **MENU**.  
The menu screen appears.
- 2 Tap the multi panel switch icons to change the multi panel.  
The selected multi panel appears.

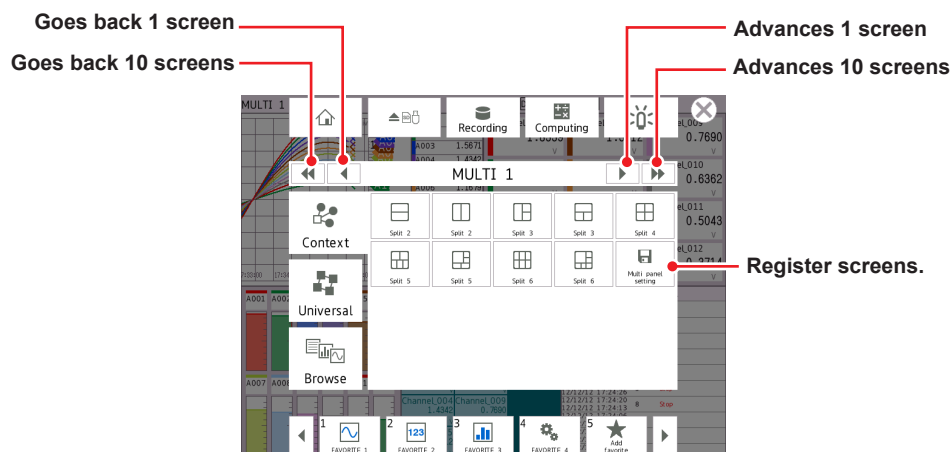

- 3 Tap the **Close** icon to close the menu screen.

Operation complete

#### Changing the Number of Areas on the Multi Panel

- 1 Press **MENU**.  
The menu screen appears.
- 2 Tap the **Context** tab.
- 3 Tap a multi panel icon.  
The multi panel with the selected number of areas appears.
- 4 Tap the **Close** icon to close the menu screen.

Operation complete

### Changing the Displayed Content of an Area of the Multi Panel

- 1 Tap the display area you want to change.  
The multi panel edit screen appears.
- 2 Tap the display icon that you want to change to. To change the group, tap the display group switch icons.  
The specified display appears.
- 3 Tap the **Close** icon.  
The multi panel edit screen closes.

[Operation complete](#)

### Registering the Multi Panel That You Changed

- 1 Press **MENU**.  
The menu screen appears.
- 2 Tap the **Context** tab and then **Multi panel setting**.  
The multi panel setting screen appears.
- 3 Set the multi panel name, and tap **OK**.  
The multi panel is registered.

[Operation complete](#)

## 2.2.5 Writing Registered Messages and Free Messages

You can recall preset messages and write them. You can also create messages and write them (free messages).

Written messages cannot be deleted or modified.

### Procedure

#### Writing a Registered Message

- 1 Display the group that you want to write a message to.
  - If **Write group** is set to **Separate**, the message is written to the currently displayed group.
  - If a display unrelated to a group such as the overview display is shown, messages are written to all groups even when **Write group** is set to **Separate**. In multi panel, messages are written to the displayed groups.
  - Messages are written to all groups when **Write group** is set to **Common**.

- 2 Press **MENU**.  
The menu screen appears.

- 3 Tap the **Universal** tab and then **Message**.  
A message list appears.

If Trend rate switching (Second interval) is set to **On** and you specify the message input position by moving the scale image or by scrolling the waveform, a screen for switching to the historical trend screen will appear. Tap a data type to switch to the historical trend.

In trend display, **Message** also appears on the **Context** tab.

- 4 Select the message field to write, and tap **OK**.  
The message is written.

If the historical trend is displayed, press **MENU**, select the **Context** tab, and tap **Exit** to return to the original screen.

[Operation complete](#)

### Shortcut Icon Operation (for registered and free messages)

You can touch the screen to display shortcut icons; you do not have to display the menu screen first.

You can tap these shortcut icons to operate the GX/GP.

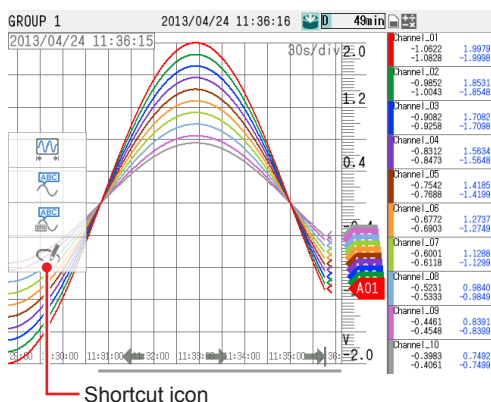

### Writing a Free Message

You can create a message on the spot and write it.

You can set up to 10 free messages.

- 1 Press **MENU**.  
The menu screen appears.
- 2 Tap the **Universal** tab.  
The menu appears.
- 3 Tap **Free message**.  
A message list appears.

If Trend rate switching (Second interval) is set to **On** and you specify the message input position by moving the scale image or by scrolling the waveform, a screen for switching to the historical trend screen will appear. Tap a data type to switch to the historical trend.

In trend display, **Free message** also appears on the **Context** tab.

- 4 Tap the message field to write in.  
A keyboard will appear.
- 5 Set the message to write, and tap **OK**.  
The message that you entered is written.

If the historical trend is displayed, press **MENU**, select the **Context** tab, and tap **Exit** to return to the original screen.

#### Operation complete

#### Note

You cannot write messages when recording is stopped.

### Writing an Added Message

You can add messages to past data.

- ▶ See page 2-31 in section 2.2.7, “Displaying Previously Measured Data (Historical trend display)”.

#### • Writing a Registered Message

- 1** Display the historical trend, and drag the scale image to align the left edge of the scale image to the write position.
- 2** Press **MENU**.  
The menu screen appears.
- 3** Tap the **Context** tab and then **Message**.  
A message list appears.
- 4** Select the message field to write to, and tap **OK**.  
The message is written.

Operation complete

### Shortcut Icon Operation (for registered and free messages)

You can touch the screen to display shortcut icons; you do not have to display the menu screen first.

You can tap these shortcut icons to operate the GX/GP.

#### • Writing a Free Message

You can create a message on the spot and write it.

- 1** Display the historical trend, and drag the scale image to align the left edge of the scale image to the write position.
- 2** Press **MENU**.  
The menu appears.
- 3** Tap the **Context** tab and then **Free message**.  
A message list appears.
- 4** Tap the message field to write in.  
A keyboard will appear.
- 5** Set the message to write, and tap **OK**.  
The message that you entered is written.

Operation complete



**Explanation**

**Display Color of Messages**

The message colors on the trend display are shown below. You cannot change them.

<b>No.</b>	1	2	3	4	5	6	7	8	9	10
<b>Color</b>	Red	Green	Blue	Violet	Brown	Orange	Yellow green	Light blue	magenta	Gray

The colors for messages 11 to 100 are repetitions of the colors above.

**Added Messages**

- The timestamps of added messages are data times.

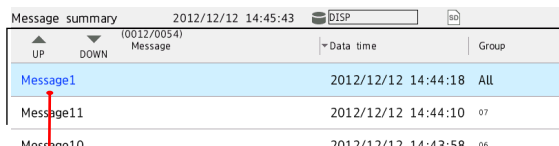

Message summary display example

**Added message (displayed in blue)**

- Up to 50 messages can be written.
- Messages cannot be added to data that has been loaded from the external storage medium.

**Message Writing When the Measurement Mode Is Set to Dual Interval**

The following table shows what messages are written depending on the currently displayed screen.

Display screen	Message writing method	Scale position	Write result	Scan group written to
Trend	Common	Latest	Written to the latest position of all display groups	All
		Past	Written to the specified data position of all display groups whose displayed trends and scan groups match.	Either one
	Separate	Latest	Written to the latest position of current display groups	Either one
		Past	Written to the specified data position of current display groups	
Custom display (when trend components or group components are present)	Common	Latest	Written to the latest position of all display groups	All
		Past	Written to the specified data position of all display groups whose trend components being controlled and scan groups match.	Either one
	Separate	Latest	Written to the latest position of current display groups * All group components displayed on the screen area applicable.	Depends on the displayed content.
		Past	Written to the specified data position of the trend component being controlled. * All components whose trend components being controlled and scan groups match are applicable.	Either one

Continued on next page

## 2.2 Configuration of Measured Data Display

Display screen	Message writing method	Scale position	Write result	Scan group written to
Multi panel Digital Bar graph	Common	—	Written to the latest position of all display groups	All
	Separate	—	Written to the latest position of current display groups * Multi panel applies to all groups displayed on the screen.	Depends on the displayed content.
Other	Common	—	Written to the latest position of all display groups	All
	Separate	—	Written to the latest position of all display groups	All

## 2.2.6 Writing Freehand Messages

You can write freehand messages on the trend and historical trend displays. Written freehand message cannot be deleted or modified when saved.

### Procedure

#### Writing on the Trend Display

- 1 Press **MENU**.  
The menu screen appears.
- 2 Tap the **Context** tab and then **Freehand message**.  
A tool box appears on the right side of the screen. Displayed in the upper right when the trend display direction is vertical

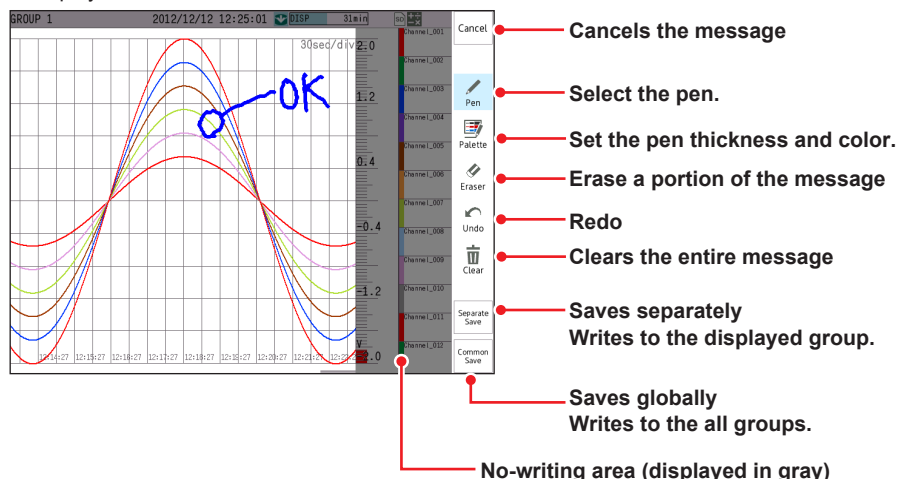

If Trend rate switching (Second interval) is set to **On**, a screen for switching to the historical trend screen will appear.

- 3 Write the message, and then tap **Save** or **Common**.  
The message is written.

If the historical trend is displayed, press **MENU**, select the **Context** tab, and tap **Exit** to return to the original screen.

#### Operation complete

#### Shortcut Icon Operation (for trend and historical trend)

You can touch the screen to display shortcut icons; you do not have to display the menu screen first.

You can tap these shortcut icons to operate the GX/GP.

#### Note

If you perform any of the following operations, the written message section is displayed with dotted lines.

- Change the waveform magnification (pinch apart/together).
- Change the waveform direction (vertical to horizontal or horizontal to vertical).
- Change the position of the digital values on the trend screen.

### Writing on the Historical Trend

- 1 Display the historical trend, and show the location where you want to write a freehand message.
- 2 Press **MENU**.  
The menu screen appears.
- 3 Tap the **Universal** tab and then **Freehand message**.  
A tool box appears on the right side of the screen. Displayed in the upper right when the trend display direction is vertical
- 4 Write the message, and then tap **Save** or **Common**.  
The message is written.
- 5 Press **MENU**. Tap the **Context** tab and then **Exit**.  
The GX/GP returns to the original screen.

#### Operation complete

#### **Note**

//////////  
If you perform any of the following operations, the written message section is displayed with dotted lines.

- Change the waveform magnification (pinch apart/together).
- Change the waveform direction (vertical to horizontal or horizontal to vertical).
- Change the position of the digital values on the trend screen.

Using second interval [div] (Recording interval)  
//////////

## 2.2.7 Displaying Previously Measured Data (Historical trend display)

There are five methods to display the previously measured data.

Recall from the display (explained in this section)

Display from the alarm summary (▶ page 2-43 in section 2.3.1, "Listing the Log of Alarm Occurrences and Releases (Alarm Summary)")

Display from the message summary (▶ page 2-45 in section 2.3.2, "Displaying the Log of Written Messages (Message summary)")

Display from the memory summary (▶ page 2-47 in section 2.3.3, "Displaying a List of Data Files in the Internal Memory and Saving Data (Memory summary)")

Show the measured data stored on an external storage medium (▶ page 2-85 in section 2.8.2, "Loading and Displaying the Measured Data (Display data and event data) from the Storage Medium")

The waveform display area of historical trends shown from an alarm summary, message summary, memory summary, external storage medium, or written message is displayed in gray.

### Procedure

#### Direction is Horizontal

Drag or flick the screen to the right on the trend display.

The waveform scrolls, and previously measured data appears.

To display the current data, scroll to the right edge.

#### Direction is Vertical

Drag or flick the screen to the top on the trend display.

The waveform scrolls, and previously measured data appears.

To display the current data, scroll to the top edge.

Touching the screen shows a scroll icon.

You can touch the icon to scroll.

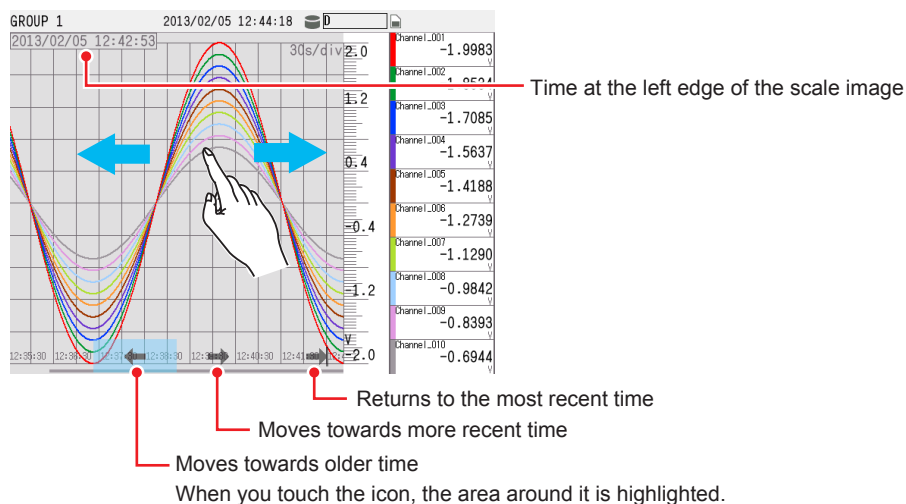

### Exit the Historical Trend Display

You can carry out this procedure on the historical display(screen?).

- 1 Press **MENU**.  
The menu screen appears.
- 2 Tap the **Context** tab and then **Exit**.  
The screen returns to the display that was showing before you switched to the historical trend.

Operation complete

### Displaying the Entire Measured Data

- 1 Press **MENU**.  
The menu screen appears.
- 2 Tap the **Context** tab and then **All data display**.  
The entire measured data is displayed.

It may not be possible to display all the measured data depending on the measure data size. You can use the switch icons to change the range to load. If there is measured data that can be loaded, switch icons appear in gray and are enabled. Otherwise, switch icons appear dimmed (light gray) and are disabled.

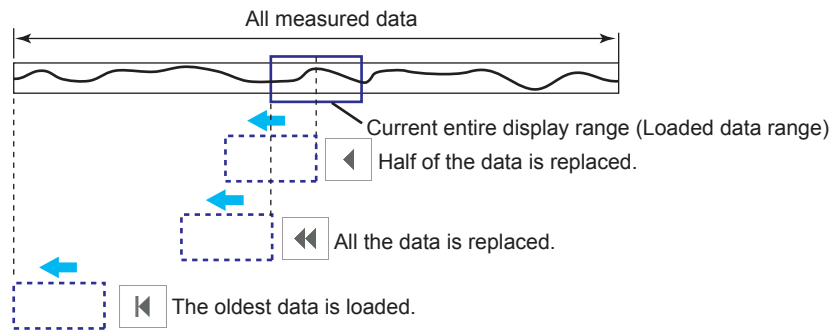
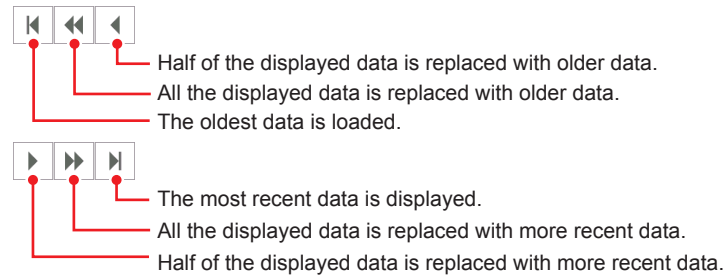
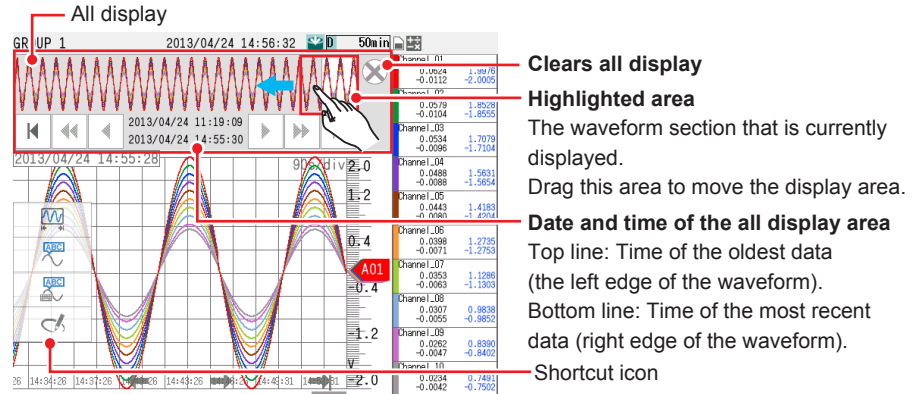

#### Operation complete

#### Shortcut Icon Operation

You can touch the screen to display shortcut icons; you do not have to display the menu screen first. You can tap these shortcut icons to operate the GX/GP.

### Expanding and Reducing the Time Axis

Direction is Horizontal

Pinch together horizontally to reduce the screen; pinch apart to expand the screen.

Direction is Vertical

Pinch together vertically to reduce the screen; pinch apart to expand the screen.

- Display data: 1x to 1/8x of the trend display
- The expansion and reduction ratios for display data vary depending on the trend interval. The ratios for event data vary depending on the recording interval.

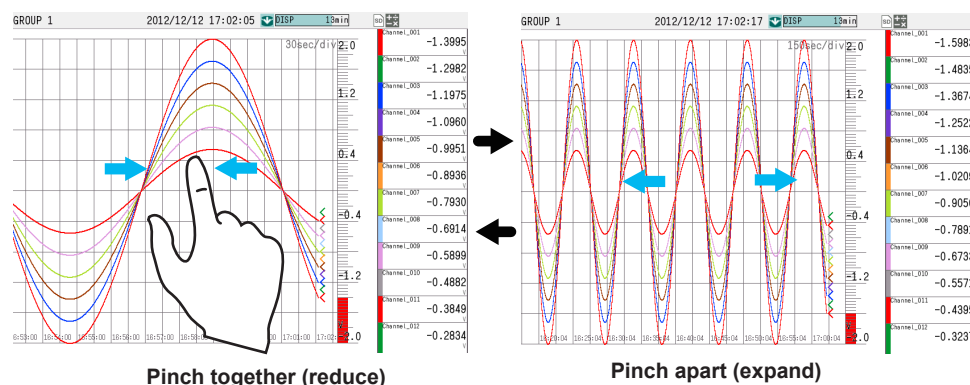

### Expanding and Reducing the Display Span

Direction is Horizontal

Pinch together vertically to reduce the screen; pinch apart to expand the screen.

Direction is Vertical

Pinch together horizontally to reduce the screen; pinch apart to expand the screen.

- Display data: x1 to the maximum magnification of the span value.
- The minimum and maximum magnifications depend on the channel type, and other settings.

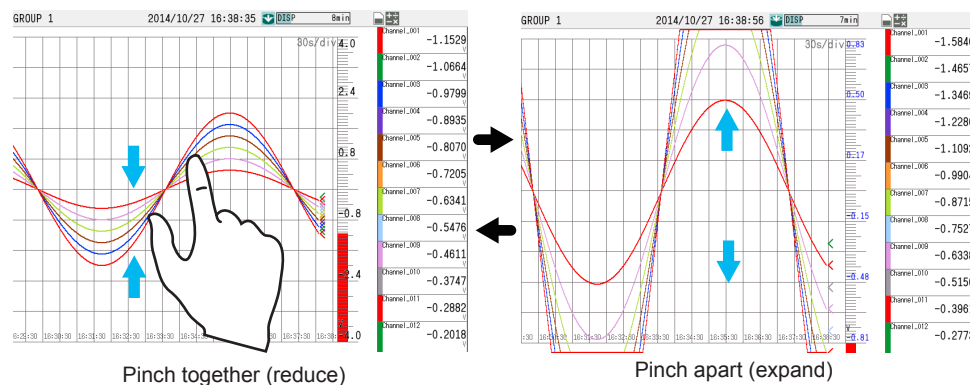

#### Note

- The span value on the side that was pinched together or pinched apart with your fingers is changed.
- Channels in the same scale position as the selected channel are also expanded.
- Channels whose partial expanded display is set to ON cannot be expanded.
- When custom display is in use, if the 2nd span is set to ON, expanding is not possible.
- The expanded condition is reset when the display is switched.
- For scales that include expanded channels, the characters are displayed in blue.
- If there are expanded channels, all scale digits are shown in detail display.

### Displaying the Trend Waveform of the Selected Channel on Top

You can display the waveform and the scale image marker of the selected channel on top. The waveform display area shows the grid for the selected channel. If you change the historical trend display to another display, the top channel display setting will be cleared. All other channels are displayed in order according to their order of assignment to the display group.

### Displaying the Waveform of the Selected Channel on Top

- 1 Tap a channel on the digital display. The tapped area is selected, and the trend waveform of the corresponding channel is displayed on top.

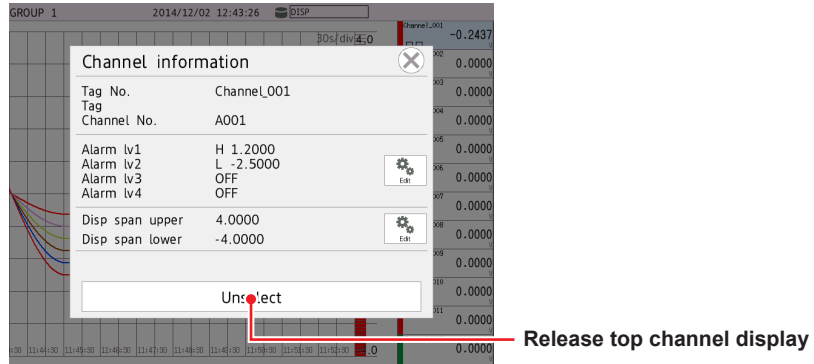

- 2 Tap the **Close** icon to close the channel information screen.

#### Operation complete

### Clearing the Top Channel Display

- 1 Tap the selected digital display area. The channel information screen appears.
- 2 Tap **Unselect**. The top channel display is cleared.

#### Operation complete

### Reading Measured Values

Drag the scale image.

The measured value of the scale's left edge position is shown in the digital display section. For display data, the maximum measured value is displayed. For event data, the measured value is displayed.

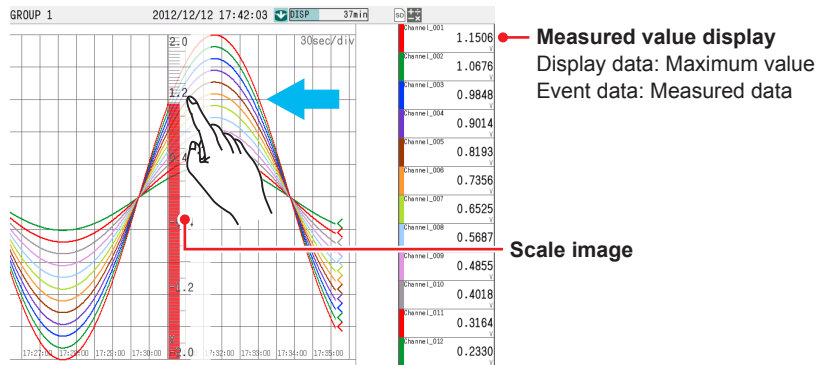



## Displaying Measured Data with Maximum values or Min/Max Values

- 1 Press **MENU**.  
The menu screen appears.
- 2 Tap the **Context** tab and then **Valu Max Max/Min**.  
The digital display switches to Maximum or Min/Max display.  
Each time you tap Min/Max (Value Max Min/Max), the display switches between Maximum and Min/Max.

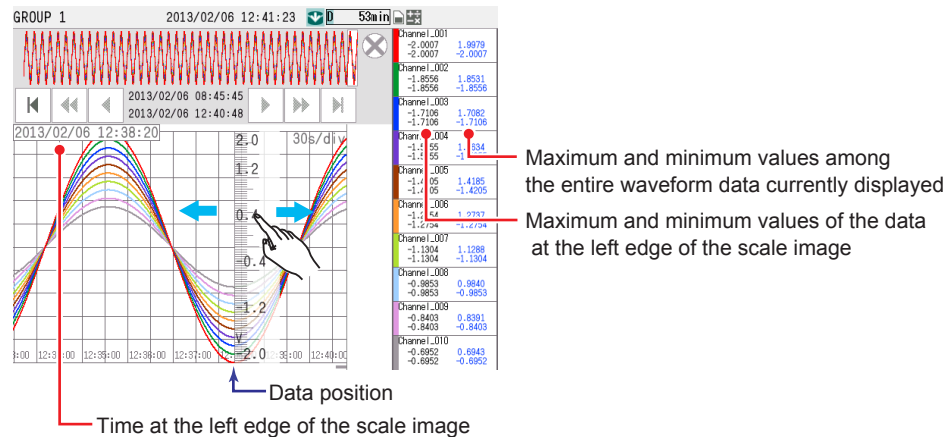

- 3 Tap the **Exit** icon (✕).  
Close the menu screen.

### Operation complete

#### Note

If the scale image had been moved, after you switch the display, the image will return to its original position.

## Switching the Group to Display

- ▶ page 2-19 in section 2.2.2, “Switching the Group to Display”

## Writing Registered Messages and Free Messages

- ▶ page 2-24 in section 2.2.5, “Writing Registered Messages and Free Messages”

## Writing Freehand Messages

- ▶ page 2-29 in section 2.2.6, “Writing Freehand Messages”

## Displaying the Alarm Summary of the Loaded Data

### • Displaying the Alarm Summary

- 1 Press **MENU**.  
The menu screen appears.
- 2 Tap the **Context** tab and then **Alarm summary**.  
The alarm summary appears.

### Operation complete

- ▶ For details on the alarm summary, see page 2-43 in section 2.3.1, “Listing the Log of Alarm Occurrences and Releases (Alarm Summary)”.

- **Returning to the Historical Trend Display**

- 1** Press **MENU**.  
The menu screen appears.
- 2** Tap the **Context** tab and then **Trend**.  
The screen returns to the historical display.

[Operation complete](#)

### Displaying the Message Summary of the Loaded Data

- **Displaying the Message Summary**

- 1** Press **MENU**.  
The menu screen appears.
- 2** Tap the **Context** tab and then **Message summary**.  
The message summary appears.

[Operation complete](#)

- ▶ For details on the message summary, see page 2-45 in section 2.3.2, “Displaying the Log of Written Messages (Message summary)”.

- **Returning to the Historical Trend Display**

- 1** Press **MENU**.  
The menu screen appears.
- 2** Tap the **Context** tab and then **Trend**.  
The screen returns to the historical display.

[Operation complete](#)

## Displaying Data File Information

You can display the memory information of the measured data that is currently displayed.

- 1 Press **MENU**.  
The menu screen appears.
- 2 Tap the **Context** tab and then **Data information**.  
The data information appears.

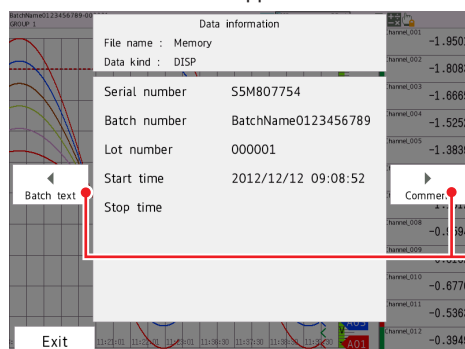

Display switch icons  
Switch the page

Display	Description
File name	Data in the internal memory that has not been made into a file is indicated as "Memory." For data that has been made into a file, the file name is displayed.
Data type	Display data is displayed as "Display." Event data is displayed as "Event."
Serial No.	The serial number of the GX/GP that was used.
Batch number and lot number	These appear when the file was created using the batch function.
Start time, End time	The record start and end times.
Start user	The name of the user that started recording. This appears when the login function was used.
Stop user	The name of the user that stopped recording. This appears when the login function was used.
Comment	Comment (when the batch function was used).
Text field	Text field (when the batch function was used).

- 3 Tap **Exit**.  
The data information screen closes.

### Operation complete

#### Note

- When measured data on the external storage medium is displayed, the serial number corresponds to that of the GX/GP that was used to save the data.
- When the measurement mode is set to Dual interval, custom displays do not show data information.

### Displaying the Measured Data from a Specified Date and Time

You can search for measured data at the specified date and time and display the results. You can search the display data or event data in the GX/GP internal memory.

- 1 Press **MENU**.  
The menu screen appears.
- 2 Tap the **Context** tab and then **Data search**.  
A calendar appears.

When the measurement mode is set to Dual interval, the data (event 1 and event 2) of each scan group is displayed.

- 3 Tap a date.  
The data search screen appears.

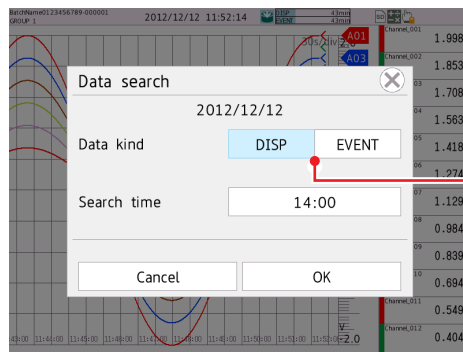

When the measurement mode is set to **Dual interval**  
Data kind: Event 1, Event 2

- 4 Set the data kind and search time, and tap **OK**.  
Data will appear.

#### Operation complete

### Display Conditions

- The scale's left edge position is the specified search time.
- All other display conditions are the same as those of the current display.
- If there is no data at the date and time that you specify, data from a later time in the same day is displayed. If such data does not exist, an error message will appear.
- If the detected data does not contain the same display group as the groups that are displayed currently, the first group among the displayed groups is displayed.

### Searchable Range

You can search for data between the year 2001 and the year 2035.

#### “DISP” and “EVENT” Indications

“DISP” appears when there is display data on the specified day.

“EVENT” appears when there is event data on the specified day.

You can configure the calendar so that weeks start with Sunday or Monday.

- ▶ For details on the settings, see page 1-117 in section 1.10.5, “Setting Basic Screen Items”.

### Signing In (When using the advanced security function (/AS option))

- ▶ See section 2.4, “Signing Display and Event Data,” in the Advanced Security Function (/AS) User's Manual (IM 04L51B01-05EN).

## 2.2.8 Switching to the Secondary Trend Interval

You can switch the trend interval.

To do so, in **Display settings**, under **Trend interval**, you need to set **Trend rate switching** to **On**.

► For the setup procedure, see page 1-110 in section 1.10.1, “Setting the Trend Interval”.

You can configure the GX/GP so that a message is written automatically when the trend interval is changed. To do so, in **Display settings**, under **Trend setting**, you need to set message **Change message** to **On**.

► For details on the settings, see page 1-114 in section 1.10.4, “Setting Trend Display Conditions”.

### Procedure

- 1 Press **MENU**.  
The menu screen appears.
- 2 Tap the **Context** tab and then **DispRate First/Second**.  
The trend interval switches from First to Second. A message appears in the trend display (if the function is enabled).  
Display example: 10:53      1min/div

Each time you tap **DispRate First/Second**, the setting toggles between First and Second.

- 3 Tap the **Close** icon to close the menu screen.

### Operation complete

### Note

- Only the displayed time axis changes when you switch to the secondary trend interval. The trend interval of recording data does not change.
- When the measurement mode is set to High speed or Dual interval, the secondary trend interval cannot be used.

## 2.2.9 Registering and Showing the Standard Display

### Procedure

#### Registering the Standard Display

- 1 Show the display that you want to register as the standard display.
- 2 Press **MENU**.  
The menu screen appears.
- 2 Tap the **Universal** tab and then **Standard display**.  
The standard display setting screen appears.
- 3 Tap **OK**.  
The standard display is registered.

Operation complete

#### Showing the Standard Display

- 1 Press **MENU**.  
The menu screen appears.
- 2 Tap the **Standard** icon.  
The standard display is shown.

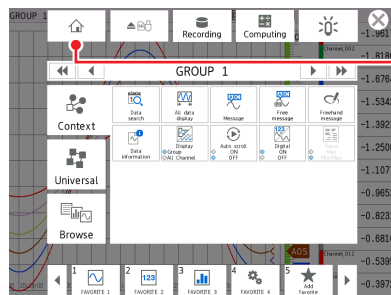

Shows the standard display

Operation complete

#### Note

If you register the standard display on the historical trend screen, the trend display of the displayed group will be registered as the standard display.

## 2.2.10 Loading and Displaying Display Data and Event Data from the External Storage Medium

- ▶ See page 2-85 in section 2.8.2, “Loading and Displaying the Measured Data (Display data and event data) from the Storage Medium”.

### 2.2.11 Displaying Future Pen (Predicted future waveforms) (Release number 4 (Version 4.08) and later)

When the future pen function is set, the predicted future waveform based on the future pen is drawn on the trend display screen.

- For the procedure to set the future pen, refer to page 1-281 in section 1.33, “Setting the Future Pen, Using the Future Alarm (Release number 4 (Version 4.08) and later)”.

#### Predicted future waveform display

Predicted future waveforms are displayed by learning from past data. When a minimum of 30 data points have been collected after the start of recording, the predicted future waveform is drawn (60 points) in the predicted future waveform area. The predicted future waveform is updated based on the update interval of the recorded data.

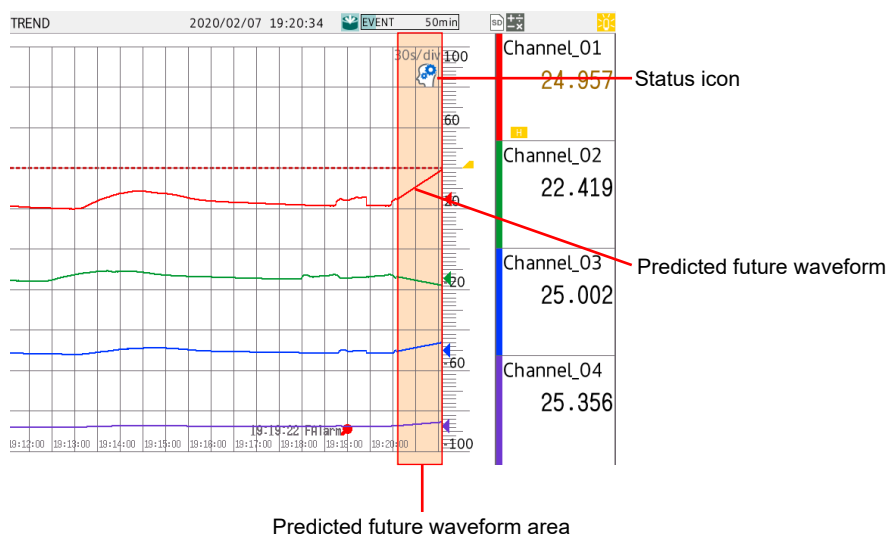

#### Status Icon

Icon	Description	Predicted future waveforms
	Appears while collecting data necessary for future prediction. When data collection is completed, the predicted future waveform appears and the icon disappears.	Not displayed
	Appears while optimizing the predicted future waveform. When the optimization is completed, it is reflected in the predicted future waveform and the icon disappears.	Displayed
	Appears when the predicted future waveform cannot be displayed. To display the predicted future waveform, you must change the settings. When you change to a setting that can be displayed, the icon disappears. ► Refer to Display conditions in page 1-281 in section 1.33.1, “Setting the Future Pen, Future Pen Channels”.	Not displayed

#### Note

You cannot write messages in the predicted future waveform area.

**Display of the Future Waveforms When the Time Axis is Enlarged or Reduced**

When the trend waveform is pinched in (reduced) or pinched out (enlarged), the predicted future waveform is also reduced or enlarged.  
 When the waveform is reduced in the time axis direction, the number of drawn data points in the predicted future waveform area also decreases.

**Display When the Scale Image is Moved to the Predicted Future Waveform area**

Item	Displayed Content
Current value mark	Displays the most recent value of recorded data.
Digital value	Displays the most recent value of recorded data.
Alarm mark	Displays the most recent status of recorded data.
Predicted future waveforms	Fixed at the drawing content when you drag the scale image. When the scale image is returned to the latest position, the predicted waveform is updated.

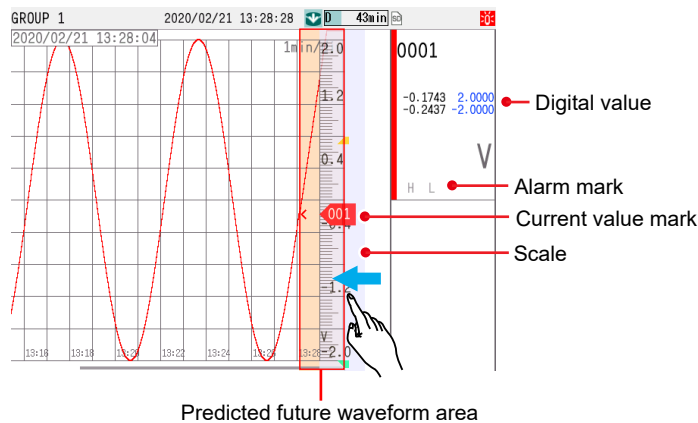

This is a screen example for Min/Max display (digital).

**Display of the predicted future waveform when error data (status) is included in the learning data**

The display of the predicted future waveform is as follows:

Data status	Display
All leaning data is error data.	No
All the last 30 data points are error data*.	No
Other	Yes (Learn by replacing error data with the previous values)

\* If all of the last 30 data points are error data, the corresponding channel enters the state immediately after the start of recording.

**Error data (status)**

Invalid data, A/D error, A/D calibration value error, +Over, -Over, +Bout, -Bout, math error, RJC error



## 2.3 Displaying Various Types of Information

This section explains how to display various types of information.

### 2.3.1 Listing the Log of Alarm Occurrences and Releases (Alarm Summary)

This section explains how to use the alarm summary.

When the measurement mode is set to Dual interval, alarm ACK remains for each scan group.

#### Procedure

#### Displaying the Alarm Summary

- 1 Tap **MENU**.  
The menu screen appears.
- 2 Tap the **Browse** tab and then **Alarm summary**.  
The alarm summary appears.

**Scroll**

**Sort item**

**Sort symbol** ▲ Ascending sort  
▼ Descending sort

**All alarm ACK**

**Individual alarm ACK**

**Drag or flick to scroll**

**Date/time of alarm occurrence/release**

**Alarm type**

**Alarm level**

**Channels on which alarms are occurring**

**▲ Alarm occurrence**  
ON ( ▲ blinks until the alarm ACK operation is carried out if "Indicator" is set to "Hold." )

**▼ Alarm release**  
OFF

**● Alarm output release (when alarm ACK is performed)**  
ACK

#### Operation complete

#### Scrolling the Alarm Display

You can scroll the display in the following manner.

- Drag or flick the data display area up or down.
- Scroll icons  
UP: Scrolls the alarm information up  
Down: Scrolls the alarm information down

### Sorting Items in Ascending or Descending Order

Tap a sort item to sort the list.

You can sort alarms in ascending or descending order by the following items. The sort symbol is displayed next to the sort item (see the figure on the previous page).

- Channel number: Sorts the alarms by channel number even when tags are in use. Alarms within a single channel are displayed in order according to the occurrence and release times.
- Level: Sorts the alarms by the alarm level number.
- Type: Sorts the alarms in the following order: H: High limit, L: Low limit, R: High limit on rate-of-change, r: Low limit on rate-of-change, T: Delay high limit, t: Delay low limit, h Difference high limit, and l Difference low limit.
- Occurrence and release times

### Displaying the Historical Trend at the Alarm Occurrence Time

**1** Tap the alarm display.  
The alarm information screen appears.

**2** Tap **Go to trend(Disp)** or **Go to trend(Event)**.  
The selected type of data is displayed in the historical trend.

When the measurement mode is set to Dual interval

Tap **Go to trend(Event1)** (Measurement group 1) or **Go to trend(Event2)** (Measurement group 2).

If you select a scan group different from the alarm, a trend screen close to the specified alarm is displayed. If the trend screen cannot be displayed, an error (E532) appears.

Operation complete

- For the historical display procedure, see page 2-31 in section 2.2.7, “Displaying Previously Measured Data (Historical trend display)”.

### Switching the Display Mode

**1** Tap **MENU**.  
The menu screen appears.

**2** Tap the **Context** tab and then **Display Watch/List**.  
List: Displays all alarms.  
Watch: Displays only the alarms that are occurring.

Operation complete

### Saving Alarm Summary

**1** Tap **MENU**.  
The menu screen appears.

**2** Tap the **Context** tab and then **Save alarm**.  
A save destination selection screen is displayed.

**3** Set the save destination, and tap **OK**.  
The alarm summary information in the internal memory is saved to a text file.

Operation complete

### Displaying Milliseconds (Release number 2 and later)

- 1 Tap **MENU**.  
The menu screen appears.
- 2 Tap the **Context** tab and then **Milli Second ON/OFF**.  
Time display or Milli second display is shown.

Each time you tap Milli Second ON/OFF, the display toggles between time display and Milli second display.

Operation complete

### 2.3.2 Displaying the Log of Written Messages (Message summary)

This section explains how to use the message summary.  
The message summary displays a list of written messages and their timestamps. Up to 450 messages can be displayed.  
Up to 50 added messages (messages that have been added to previously measured data) can be displayed.

#### Procedure

#### Displaying the Message Summary

- 1 Press **MENU**.  
The menu screen appears.
- 2 Tap the **Browse** tab and then **Message summary**.  
The message summary appears.

**Scroll**

**Sort by item.**

Message	Date and time	Group
Message11	2012/12/12 09:24:58	07
Message10	2012/12/12 09:24:50	06
Message9	2012/12/12 09:24:39	05
Message8	2012/12/12 09:24:30	04
Message7	2012/12/12 09:24:20	03
Message6	2012/12/12 09:24:08	02
Message5	2012/12/12 09:23:52	01
Message4	2012/12/12 09:23:49	01
Message3	2012/12/12 09:23:45	01
Message2	2012/12/12 09:23:42	01
Message1	2012/12/12 09:23:37	01

**Sort symbol**

▲ Ascending sort  
▼ Descending sort

**Drag or flick to scroll**

**Message**  
Added message (displayed in blue)

**Date and time when the message was written**

**Destination group to write the message**

Operation complete

#### Scrolling the Message Display

You can scroll the messages in the following manner.

- Drag or flick the data display area up or down.
- Scroll icons  
UP: Scrolls the messages up  
DOWN: Scrolls the messages down

### Sorting Items in Ascending or Descending Order

Tap a sort item to sort the list.

You can sort messages in ascending or descending order by the following items. The sort symbol is displayed next to the sort item (see the figure above).

- Message
- Time when the message was written
- Group

### Displaying the Historical Trend at the Time a Message Was Written

**1** Tap a message.  
The message information screen appears.

**2** Tap **Go to trend(Disp)** or **Go to trend(Event)**.  
The selected type of data is displayed in the historical trend.

When the measurement mode is set to Dual interval

Tap **Go to trend(Event1)** or **Go to trend(Event2)**.

If the trend screen cannot be displayed, an error (E532) appears.

#### Operation complete

- ▶ For the historical display procedure, see page 2-31 in section 2.2.7, "Displaying Previously Measured Data (Historical trend display)".

### 2.3.3 Displaying a List of Data Files in the Internal Memory and Saving Data (Memory summary)

This section explains how to use the memory summary.

The memory summary displays display data and event data information of the internal memory.

Number of displayed files

GX10/GP10/GX20-1/GP20-1: 500 max.

GX20-2/GP20-2: 1000 max.

#### Procedure

#### Displaying the Memory Summary

- 1 Press **MENU**.  
The menu screen appears.
- 2 Tap the **Browse** tab and then **Memory summary**.  
The memory summary appears.

When the measurement mode is set to **Dual interval**, the display can be switched between event data 1 and event data 2.

**Scroll**

**Time of the most recent manual sampled data and report data**

**Switch data type and display**

**Switch event data**

**Number of data entries in the internal memory/ Maximum number of data entries that can be recorded in the internal memory**

**Drag or flick to scroll**

**File name**

**Status**

**Recorded data entry**

**Recording start/stop date and time**

**Select data.**

UP	DOWN	Stop time	Data	Factor	File name
		2012.12.12 13:05:38	13	Recording	
		2012.12.12 13:01:14	300	Auto save	000027_121212_125114.GDS
		2012.12.12 13:01:12	300	Auto save	000026_121212_125114.GDS
		2012.12.12 12:51:14	300	Auto save	000025_121212_123114.GDS
		2012.12.12 12:51:12	300	Auto save	000024_121212_122114.GDS
		2012.12.12 12:41:14	300	Auto save	000023_121212_121114.GDS
		2012.12.12 12:41:12	300	Auto save	000022_121212_120114.GDS
		2012.12.12 12:31:14	300	Auto save	000021_121212_120038.GDS
		2012.12.12 12:31:12	300	Auto save	000020_121212_115038.GDS
		2012.12.12 12:21:14	300	Auto save	000019_121212_114038.GDS
		2012.12.12 12:21:12	300	Auto save	000018_121212_113038.GDS
		2012.12.12 12:11:14	300	Auto save	000017_121212_112038.GDS
		2012.12.12 12:11:12	300	Auto save	000016_121212_111038.GDS
		2012.12.12 12:00:52	8	Stop	000015_121212_110038.GDS
		2012.12.12 12:00:38	300	Auto save	000014_121212_109038.GDS
		2012.12.12 12:00:36	300	Auto save	000013_121212_108038.GDS
		2012.12.12 11:50:38	300	Auto save	000012_121212_107038.GDS
		2012.12.12 11:50:36	300	Auto save	000011_121212_106038.GDS
		2012.12.12 11:40:38	300	Auto save	000010_121212_105038.GDS

**Operation complete**

### Displaying the Historical Trend of the Data Specified in the Memory Summary

- 1 Tap a memory item.  
The memory information screen appears.
- 2 Tap **Go to trend**.  
The selected type of data is displayed in the historical trend.

**Operation complete**

- ▶ For the historical display procedure, see page 2-31 in section 2.2.7, “Displaying Previously Measured Data (Historical trend display)”.

### Saving Data

You can save the internal memory data to an SD memory card or USB flash memory (/UH option).

- **Saving a Specific File**

- 1 On the memory summary display, select the check box next to the file you want to save.

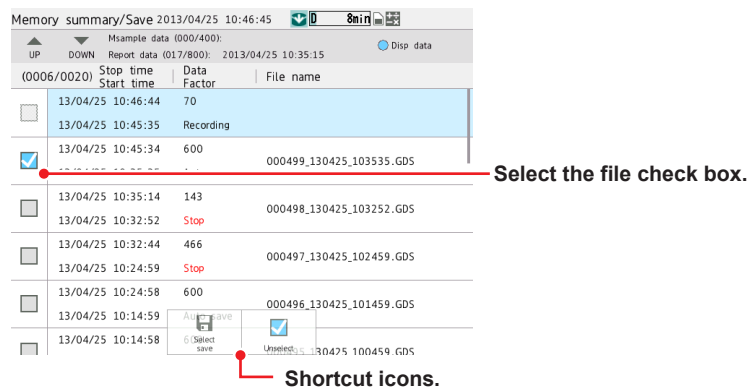

- 2 Press **MENU**.  
The menu screen appears.
- 3 Tap the **Context** tab and then **Select save**.  
The select save screen appears.

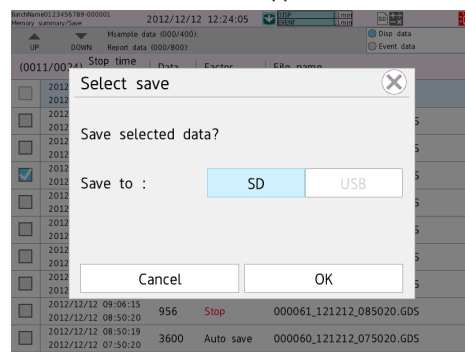

- 4 Set the save destination, and tap **OK**.  
The progress of the save operation appears. Data whose check box is selected is saved.
- 5 Tap the **Close** icon.  
The screen closes.

**Operation complete**

### Shortcut Icon Operation

You can touch the screen to display shortcut icons; you do not have to display the menu screen first.

You can tap these shortcut icons to operate the GX/GP.

#### Note

To cancel the data save operation, carry out the following procedure.

**MENU > Universal > Save stop**

#### • When Saving All Data, Manual Sampled Data, or Collectively Saving Display and Event Data or Report Data (Release number 2 and later)

- 1 Press **MENU**.  
The menu screen appears.
- 2 Tap the **Context** tab and then **All save**, **Disp/Event save**, **M.sample save** or **Report save**.  
The all data, display/event data, manual sampled data, or report data save screen appears.
- 3 Set the save destination, and tap **OK**.  
The data is saved.

#### Operation complete

#### Note

To cancel the data save operation, carry out the following procedure.

**MENU > Universal > Save stop**

#### • Progress Indication When Saving the Data in the Internal Memory

If you execute **Select save**, **All save**, **M. sample save**, or **Report save** on the memory summary display, the progress of the operation is indicated on the screen.

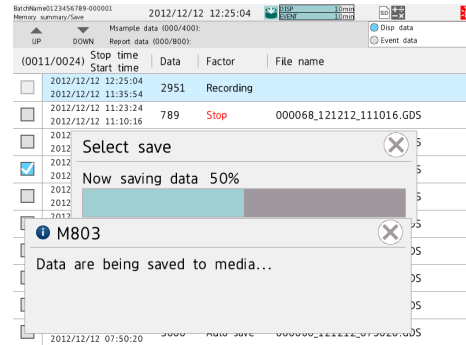

#### Note

- This screen appears only when the memory summary display is showing.
- If you tap the **Close** icon, the screen will temporarily disappear but will reappear about 10 seconds later.
- The estimated length of time to save all data is shown in the table below (when the memory is full of data). It will take longer depending on the GX/GP operating conditions.

Save Destination	Estimated Length of Time to Save All Data
Internal memory size 500 MB (GX20-1/GP20-1/GX10/GP10)	SD memory card, USB flash memory Approx. 30 minutes
Internal memory size 1.2 GB (GX20-2/GP20-2)	Approx. 1 hour

- To cancel the data save operation, carry out the following procedure.  
**MENU > Universal > Save stop** (when saving all data or report data)

### Signing In (When using the advanced security function (/AS option))

See section 2.4, "Signing Display and Event Data," in the Advanced Security Function (/AS) User's Manual (IM 04L51B01-05EN).

#### Explanation

#### Saving Data

- The GX/GP will create a new directory to store the data in each time you save data. Directory name: Specified string\_YYMMDD\_HHMMSS (the values of YY to SS are the date and time of operation).

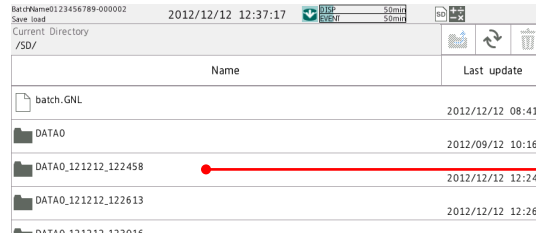

- Display data or event data that is in the process of adding data cannot be saved.
- The save operation explained here merely copies the data in the internal memory. It does not save the unsaved data in the internal memory (▶ see the explanation in page 1-143 in section 1.14.2, "Setting the Save Method to Media (Auto save or manual save) and Media FIFO").
- Data saving is aborted when the storage medium becomes full. Use a storage medium with sufficient free space when saving data.



### 2.3.4 Displaying Reports

You can display the report data in the internal memory.

**Procedure**

#### Displaying Report Data

- 1 Press **MENU**.  
The menu screen appears.
- 2 Tap the **Browse** tab and then **Report**.  
Reports appear.

Scroll the report channels

Number of the displayed report data entry

Number of report data entries in the internal memory

Switching the Report Data

Denominator: Number of all report channels  
Numerator: The last displayed channel number

Report data status  
Indicates that the following occurred between the report interval.  
B: Burnout  
E: Error data  
O: Overflow  
P: Power failure  
C: Time change

Unit

Average, maximum, minimum, sum, or instantaneous value

Tag or channel number

Channel	Unit	Sts	Ave	Max	Min	Sum
ChanneL001	V	-----	0.1609	1.9975	-2.0009	4.777710E+01
ChanneL002	V	-----	1.8527	1.7079	-1.5227	4.431326E+01
ChanneL003	V	-----	0.1375	1.2734	-1.1353	4.084942E+01
ChanneL004	V	-----	0.1259	1.5630	-1.3936	3.738558E+01
ChanneL005	V	-----	0.1142	1.4182	-1.2644	3.392174E+01
ChanneL006	V	-----	0.1026	1.2734	-1.1353	3.045790E+01
ChanneL007	V	-----	0.0909	1.1286	-1.0062	2.699406E+01
ChanneL008	V	-----	0.0792	0.9838	-0.8771	2.353022E+01
ChanneL009	V	-----	0.0676	0.8390	-0.7480	2.006638E+01
ChanneL010	V	-----	0.0559	0.6941	-0.6189	1.660254E+01

The report window shows “the number of the displayed report data entry/the number of report data entries in the internal memory.” The largest report data number is the most recent report data entry.

**Operation complete**

### Switching the Report Data Entry to Display

You can change the report data entry to display in the following manner.

- Flick the data display area to the left and right
- Tap the report data switch icons.

Channel	Unit	Sts	Ave Max	Min Inst	Sum
Channel_001	V	-----	0.1609 1.9975	-2.0009 -1.7809	4.777710E+01
Channel_002	V	-----	0.1492 1.8527	-1.8558 -1.6518	4.431326E+01
Channel_003	V	-----	0.1375 1.7079	-1.7108 -1.5227	4.084942E+01
Channel_004	V	-----	0.1259 1.5630	-1.5657 -1.3936	3.738558E+01
Channel_005	V	-----	0.1142 1.4182	-1.4206 -1.2644	3.392174E+01
Channel_006	V	-----	0.1026 1.2734	-1.2756 -1.1353	3.045790E+01
Channel_007	V	-----	0.0909 1.1286	-1.1305 -1.0062	2.699406E+01
Channel_008	V	-----	0.0792 0.9838	-0.9854 -0.8771	2.353022E+01
Channel_009	V	-----	0.0676 0.8390	-0.8404 -0.7480	2.006638E+01
Channel_010	V	-----	0.0559 0.6941	-0.6953 -0.6189	1.660254E+01

### Scrolling Report Channels

Up to 10 (GX20/GP20) or 6 (GX10/GP10) report channels can be displayed on one screen. When there are more than 10 or 6 channels, they are displayed on separate screens.

You can scroll the report channels to display in the following manner.

- Tap the scroll icons (see the figure in “Displaying Report Data”)
- Drag or flick the data display area up or down.

### Displaying the Channel Information

Tap a report to display the channel information. Tap the **Close** icon to close.

### 2.3.5 Displaying Logs

You can display the following logs.

Operate log, error log, GENE log, FTP log, Web log, mail log, Modbus log (/MC option),  
SNTP log, DHCP log, and SLMP log (/E4 option)

Even when the measurement mode is set to **Dual interval**, there is only one set of log information. It cannot be displayed separately for each measurement group.

#### Procedure

- 1 Press **MENU**.  
The menu screen appears.
- 2 Tap the **Browse** tab and then **Log**.  
The log select screen appears.

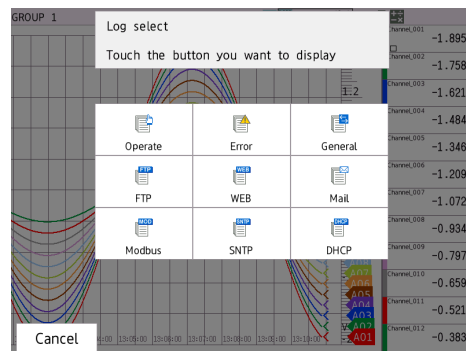

- 3 Tap the log to display.  
The selected log is displayed.

Operation complete

## 2.3 Displaying Various Types of Information

### Operate log

#### Scroll

UP	DOWN	Time	Action	Factor	User
		2012/04/14 22:47:35	PowerOn	REMOTE	1234567890123456789012345678901
		2012/04/14 22:47:34	TRevEnd	OPERATE	user54
		2012/04/14 22:47:33	TRevStart	SERIAL	user53
		2012/04/14 22:47:32	DSTEnd	SYSTEM	user52
		2012/04/14 22:47:31	DSTStart	ACTION	user51
		2012/04/14 22:47:30	SNTPtimeset	COMMU	user50

Drag or flick to scroll

User name  
Operation method (see the table below)  
Operation (see the table below)  
Date and time

Action	Description
Logi	Login
Logout	Logout
NewTime	Time change when recording is stopped
TimeChg	Time change through touch operation
PowerOff	Power off (including power failures)
PowerOn	Power on (including recoveries from power failures)
TRevStart	Start of gradually adjusting the time
TRevEnd	End of gradually adjusting the time
SNTPtimeset	Time change by SNTP
DSTStart	Start of Daylight Saving Time
DSTEnd	End of Daylight Saving Time

Factor	Description
OPERATE	Key operation, touch operation
COMMU	Operation via communication
REMOTE	Operation through the remote control function
ACTION	Operation through event action
SYSTEM	Operation by the system
SERIAL	Operation through serial communication

### Error Log

#### Scroll

UP	DOWN	Time	NO	Message
		2012/04/14 22:47:54	74	System error.
		2012/04/14 22:47:53	73	This dependency is not possible.
		2012/04/14 22:47:52	72	Cannot create object. The maximum allowed number was exceeded.
		2012/04/14 22:47:51	71	Logout cannot be set to "Hide".
		2012/04/14 22:47:50	70	System error.
		2012/04/14 22:47:49	69	System error.

Drag or flick to scroll

Error message  
Error code  
Date and time

► For the error codes and error messages, see page 5-24 in section 5.2.1, "Messages".

### General Log

**Scroll**

UP	DOWN	(000/000) Time	ID	User	Multi	I/O	Message	Link
		2012/04/14 22:50:00	e1	*****		<	*****	
		2012/04/14 22:49:59	e0	user199	*	>	Message199	
		2012/04/14 22:49:58	s0	user198		<	Message198	
		2012/04/14 22:49:57	w5	user197	*	>	Message197	
		2012/04/14 22:49:56	w4	user196		<	Message196	
		2012/04/14 22:49:55	w3	user195	*	>	Message195	

**Message**  
**Input/output symbol (>: input, <: output)**  
**Multiple commands transmitted**  
**User name**  
**User ID number**  
**Date and time**

User ID Number	Description
e0	Command exchanged through Ethernet connection #0
e1	Command exchanged through Ethernet connection #1
e2	Command exchanged through Ethernet connection #2
e3	Command exchanged through Ethernet connection #3
S0	Command exchanged through serial communication

Input/Output Symbol	Description
>	Indicates a command that the GX/GP received
<	Indicates a response that the GX/GP sent

Message	Description
(Over length)	Appears when the length of a command received by the GX/GP exceeded the limit
(Serial error)	Appears when a serial communication error occurred
(output)	Displays a response that was sent in response to an output command or setting query. This message appears in place of the response content.
(disconnected)	Appears when the GX/GP disconnected communication due to a timeout or other reason.

► For the error codes and error messages, see page 5-24 in section 5.2.1, “Messages”.

### FTP Log

**Scroll**

UP	DOWN	(000/000) Time	NO	Code	Flag	File name
		2012/04/14 22:51:09	699	NOFD	S	FTP269
		2012/04/14 22:51:08	691	LINK	P	FTP268
		2012/04/14 22:51:07	698	TIMEOUT	S	FTP267
		2012/04/14 22:51:06	693	ACCT	P	FTP266
		2012/04/14 22:51:05	693	PASS	S	FTP265
		2012/04/14 22:51:04	693	USER	P	FTP264

**File name**  
**Flag**  
**Error character string**  
**Error code**  
**Date and time**

Flag	Description
P	File was sent to the primary FTP destination.
S	File was sent to the secondary FTP destination.

► For the error codes and error messages, see page 5-24 in section 5.2.1, “Messages”.

## 2.3 Displaying Various Types of Information

### WEB Log

**Scroll**

UP	DOWN	(000/000) Time	Method	IP Address	URI	Code	Message
		2012/04/14 22:50:17	GET	255.255.255.255	http://www.hoge.co.jp/	101	Switching Protocol
		2012/04/14 22:50:16	POST	255.255.255.255	http://www.hoge.co.jp/	100	Continue
		2012/04/14 22:50:15	GET	255.255.255.255	http://www.hoge.co.jp/	505	HTTP Version Not Supported
		2012/04/14 22:50:14	POST	255.255.255.255	http://www.hoge.co.jp/	504	Gateway Time-out
		2012/04/14 22:50:13	GET	255.255.255.255	http://www.hoge.co.jp/	503	Server Unavailable
		2012/04/14 22:50:12	POST	255.255.255.255	http://www.hoge.co.jp/	502	

**Code, message**  
**URI**  
**Method, IP address**  
**Date and time**

**Drag or flick to scroll**

Method, IP address	Description
GET	Displays the HTTP method in which an error occurred. The IP address of the external device in which the error occurred is also displayed.
POST	

► For the error codes and error messages, see page 5-24 in section 5.2.1, “Messages”.

### Mail Log

**Scroll**

UP	DOWN	(000/000) Time	Type	NO	Code	Recipient/Error
		2012/04/14 22:48:47	TIMER	671	POP3ERRACH	2 Could not connect to POP3 server.
		2012/04/14 22:48:46	ALARM	674	ANDTLSPORPT	1 The server requested an unsupported authentication method.
		2012/04/14 22:48:45	TEST	673	SMTPERRAUTH	1+2 SMTP authentication failed.
		2012/04/14 22:48:44	REPORT	656	SMTPERR	2 SMTP protocol error.
		2012/04/14 22:48:43	ERROR	656	SMTPERR	1 SMTP protocol error.
		2012/04/14 22:48:42	MEMORY	656	SMTPERR	1+2 SMTP protocol error.

**Recipient/error**  
**Error code, Error Character string**  
**Cause (see table below)**  
**Date and time**

**Drag or flick to scroll**

Type	Description
ALARM	Alarm mail transmission
FALARM	Future alarm mail transmission
TIMER	Scheduled mail transmission
POWER	Power-on, power failure recovery
MEMORY	Memory full notification
ERROR	Error message mail
REPORT	Report file transmission
TEST	Test mail transmission
PASSWORD	User lock out

► For the error codes and error messages, see page 5-24 in section 5.2.1, “Messages”.

## Modbus Log

**Scroll**

UP	DOWN	Time	Kind	Factor	Command
		2012/05/02 03:02:01	M	ERR_NEGATIVE	050 R
		2012/05/03 03:02:01	C	ERR_BUSY	049 W
		2012/05/04 03:02:01	M	ERR_ACK	048 R
		2012/05/05 03:02:01	C	ERR_DEVICE	047 W
		2012/05/06 03:02:01	M	ERR_VALUE	046 R
		2012/05/07 03:02:01	C	ERR_ADDR	045 W

**Command number, command type**

**Communication status**

**Communication type (C: client, M: master)**

**Date and time**

**Drag or flick to scroll**

Flag	Description
C	Communication by the Modbus client function (Ethernet)
M	Communication by the Modbus master function (serial)

Status	Factor	Description
W		Write
R		Read
Blue ●		Normal communication.
Yellow ◆		An external Modbus device returned an error response.
Orange ■		TCP connection in progress.
Red ✕		Failed to connect to an external Modbus device.
Common to colors other than blue	Skip	Command not set.
	INVALID	Command cannot be executed.
	WAITING	Communication with an external device is congested. Waiting for recovery. Check the connection with the external device.
	CLOSED	Modbus communication was stopped, and connection to the external device was closed.
	RESOLVING	Server/slave connection being established (resolving address).
	CONNNECTING	Server/slave connection being established (requesting connection).
	UNREACH	The external device was not found on the network. Check the Modbus server address setting and Ethernet cable connection.
	TIMEDOUT	The response from the external device timed out. Check the connection with the external device.
	BROKEN	A CRC error was detected in the serial communication with the external device. Check the serial communication baud rate and other settings.
	ERR_FC	The external device returned an error response. Check whether the Modbus registers are set correctly to match the external device.
	ERR_ADDR	
	ERR_VALUE	
	ERR_DEVICE	
	ERR_ACK	
	ERR_BUSY	
	ERR_NEGATIVE	
	ERR_GATE_PATH	Check whether the Modbus connection destination unit number is correct.
	ERR_GATE_TARGET	The external device returned an error response. Check whether the Modbus registers are set correctly to match the external device.
	BAD_SLAVE	The external device returned an invalid response. Check whether the external device is operating properly.
	BAD_FC	
	BAD_ADDR	
	BAD_NUM	
	BAD_CNT	
	VALID	Modbus communication was established normally.
	START	Modbus communication started.
	STOP	Modbus communication stopped.
	DROPOUT	Failed to send all commands within the specified communication interval. Check the number of Modbus commands and the baud rate.
	NO_DATA	Data has not yet been received once. Check the communication settings.

### 2.3 Displaying Various Types of Information

Command Type	Description
R	Read command
W	Write command
O	Immediate writing <sup>1</sup>
N	Other

1 For immediate writing, the number (server number or slave number) of the write destination device appears after "O."

#### SNTP Log

The screenshot shows the SNTP log interface with the following data:

UP	DOWN	Time	Code
		2012/04/14 22:50:36	ERECV
		2012/04/14 22:50:35	ESEND
		2012/04/14 22:50:34	ETCPIP
		2012/04/14 22:50:33	EHOSTNAME
		2012/04/14 22:50:32	EDORMANT
		2012/04/14 22:50:31	EBROKEN

Error Code	Description
ELINK	The Ethernet cable is not connected. Check the GX/GP Ethernet cable connection.
EDORMANT	An internal processing error occurred. Contact your nearest YOKOGAWA dealer.
EHOSTNAME	The SNTP server host name is invalid. Check the GX/GP Ethernet cable connection, IP address setting, and SNTP server address setting.
ETCPIP	An internal processing error occurred. Contact your nearest YOKOGAWA dealer.
ESEND	Failed to transmit data to the SNTP server. Check the GX/GP Ethernet cable connection and IP address setting.
ERECV	Failed to receive data from the SNTP server. Check the GX/GP Ethernet cable connection and IP address setting.
EBROKEN	The SNTP server returned an invalid response. The SNTP server may be in a condition that cannot deliver time information. Check the SNTP server status.
ETIMEDOUT	The response from the SNTP server timed out. Check the GX/GP Ethernet cable connection.
EOVER	The time difference between the GX/GP and SNTP server has exceeded the limit for correcting the time. Check whether the SNTP server is running properly and the limit for correcting the time.
EBUSY	Could not be executed because the time is already being changed.



## DHCP Log

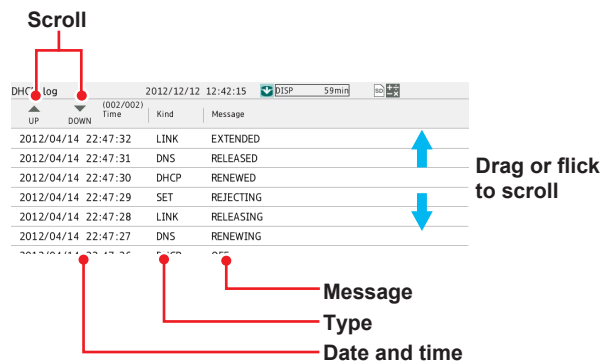

Type	Message	Description
LINK	ON	Ethernet cable connection was detected.
	OFF	Ethernet cable disconnection was detected.
SET	Address (e.g., 10.0.122.3)	The IP address of the GX/GP was set.
DHCP	OFF	The DHCP function was disabled.
	ON	The DHCP function was enabled.
	RENEWING	The IP address obtained from the DHCP server was renewed.
	RELEASING	The IP address obtained from the DHCP server was released.
	REJECTING	The IP address obtained from the DHCP server was rejected. Check whether the DHCP server is operating properly. <sup>1</sup>
	RENEWED	IP address was renewed.
	RELEASED	IP address was released.
	EXTENDED	IP address extension application complete.
	ESEND	DHCP message transmission failed. Check the Ethernet cable connection.
	ESERVER	DHCP server not found. Check whether the DHCP server is available.
	ESERVFAIL	The response from the DHCP server timed out. Check the Ethernet cable connection. Check whether the DHCP server is operating properly.
	ERENEWED	IP address renewal failed. Check the Ethernet cable connection. Check whether the DHCP server is operating properly.
	ERELEASED	IP address release failed. Check the Ethernet cable connection.
	EEXTENDED	IP address extension application failed. Check the Ethernet cable connection. Check whether the DHCP server is operating properly.
	EEXPIRED	IP address lease period expired. IP address was reset to 0.0.0.0. Check the Ethernet cable connection. Check whether the DHCP server is operating properly.
DNS	UPDATED	DNS host name registration complete.
	REMOVED	DNS host name removal complete.
	EFORMERR	DNS message syntax error was found. Check whether the DNS server is operating properly.
	ESERVFAIL	An internal processing error occurred in the DNS server. Check whether the DNS server is operating properly.
	EINTERNAL	
	ENONAME	
	ENXDOMAIN	Query to the DNS server wave rejected. Check whether the GX/GP domain name setting is correct.
	EREFUSED	
	EYXDOMAIN	The GX/GP does not support DNS servers that require host name registration authentication. Check whether the DNS server supports host name registration without authentication.
	EYXRESET	
ENXRESET		
ENOTAUTH		
ENOTZONE		

<sup>1</sup> If the GX/GP cannot accept the IP address obtained from the DHCP server, the GX/GP rejects the address and immediately returns a response to the DHCP server.

## SLMP Log

► See the SLMP Communication User's Manual (IM 04L51B01-21EN).

### 2.3.6 Checking the Command Status of the Modbus Client and Modbus Master

**Procedure**

**Displaying the Command Status**

- 1 Press **MENU**.  
The menu screen appears.
- 2 Tap the **Browse** tab and then **Modbus client** or **Modbus master**.  
The Modbus operation status appears.

**Scroll**      **Read channels**      **Register number**

**Server name**

**Tap a command to display Modbus information.**

NO	Status	Comm. Data	Server name	Registers
		First	Last	
1	W INVALID	A001 - A100	192.168.1.10	1
2	R NO DATA	C001 - C100	192.168.1.10	2
3	W WAITING	0001 - 0100	192.168.1.10	3
4	R CLOSED	A001 - A100	192.168.1.10	4
5	W RESOLVING	C001 - C100	192.168.1.10	5
6	R CONNECTING	0001 - 0100	192.168.1.10	6
7	W UNREACH	A001 - A100	192.168.1.10	7
8	R TIMEDOUT	C001 - C100	192.168.1.10	8
9	W DROPOUT	0001 - 0100	192.168.1.10	9
10	R BROKEN	A001 - A100	192.168.1.10	10

**Communication status**

Modbus information	
NO	1
Command	READ
Status	CLOSED
Type	INT16
Comm. Data	C001
First	C001
Last	
Server name	
Registers	30001
Unit No.	255
Refresh	

**Resume command transmission**

**Modbus client**

**Slave address**      **Register number**

**Command dropout icon**  
Appears when a data dropout occurs.  
The icon remains displayed until you tap it.  
Command execution times are displayed in red while the icon is displayed.  
The icon is the same for both client and master.

NO	Status	Comm. Data	Slave Address	Slave Registers
		First	Last	
1	W INVALID	A001 - A100	1	1
2	R NO DATA	C001 - C100	2	2
3	W WAITING	0001 - 0100	3	3
4	R CLOSED	A001 - A100	4	4
5	W RESOLVING	C001 - C100	5	5
6	R CONNECTING	0001 - 0100	6	6
7	W UNREACH	A001 - A100	7	7
8	R TIMEDOUT	C001 - C100	8	8
9	W DROPOUT	0001 - 0100	9	9
10	R BROKEN	A001 - A100	10	10

**Modbus master**

- 3 Tap a command to display the Modbus information.

Operation complete

**Switching between List and Overview Displays**

You can switch between list and overview displays.

- 1 Press **MENU**.  
The menu screen appears.
- 2 Tap the **Context** tab and then **Display Overview/List**.  
The list display or overview display appears.

Each time you tap **Display Overview/List**, the setting toggles between list display and overview display.

Operation complete

### Communication Condition

The following settings are displayed. The setting display varies between Modbus client and Modbus master.

Function	Setup Item	Display
Modbus client	Wait time	Auto recovery
	Interval	Read cycle
Modbus master	Communication timeout	Time out
	Retransmission	Retrials
	Wait time	Auto recovery

### Communication Status

▶ See page 2-53 in section 2.3.5, “Displaying Logs”.

### Resuming Command Transmission

You can use touch operation to resume command transmission to a server to which communication is stopped (red status lamp).

- 1 Select the command to send to the server.  
The Modbus information appears.
- 2 Tap **Refresh**.  
The GX/GP starts command transmission to the specified server.

Operation complete

### Data When Communication Is Stopped and during Connection Retrials

If the command transmission stops such as due to a connection drop, the status turns orange or red, and the communication channel data is held at the previous value or is reset.

### Data Dropout

Data drop occurs when the commands from 1 to 100 from the GX20-1/GP20-1, from 1 to 200 from the GX20-2/GP20-2, or from 1 to 50 from the GX10/GP10 do not complete within the read cycle. When a data dropout occurs, the communication channel data is held at the previous value.

In addition, command execution times are displayed in red on the Modbus operating status display, and a command dropout icon appears.

Tap the icon to clear it. If another data dropout occurs, the icon will reappear.

A message indicating the data dropout is also displayed on the Modbus operation status display. If this happens, take measures such as making the read cycle longer or reducing the number of commands. Confirm that no data dropout occurs on the Modbus status log screen.

### 2.3.7 Displaying the DO Channel and Internal Switch Status (Release number 2 and later)

**Procedure**

**Displaying the Status**

- 1 Press **MENU**.  
The menu screen appears.
- 2 Tap the **Browse** tab and then **Switch/Relay**.  
The internal switch/relay status is displayed.  
Tap the internal switch or relay display area to expand the area.  
Tap a channel to display the channel information.

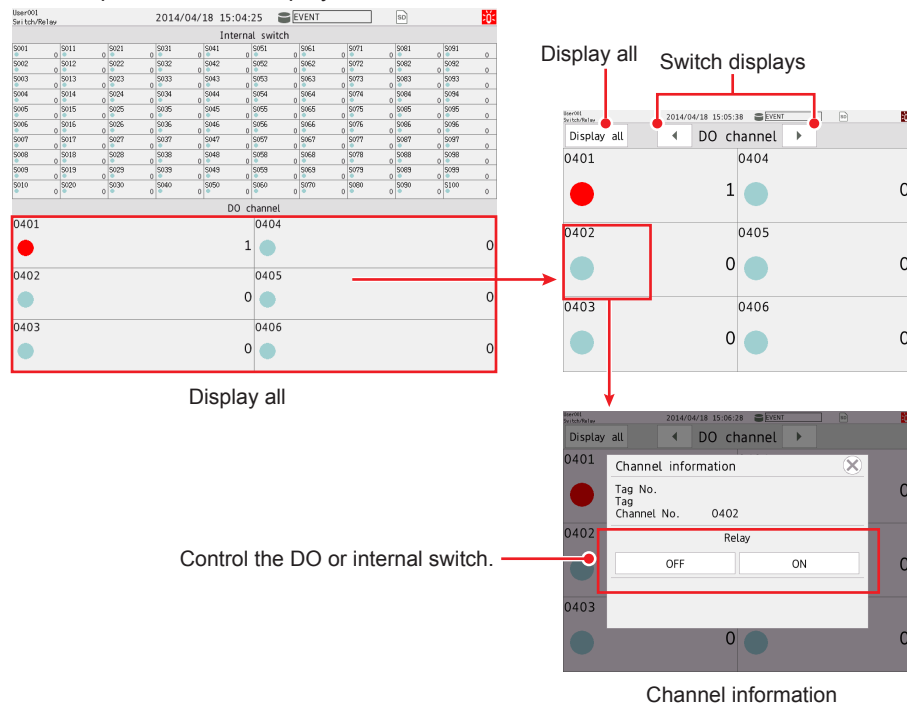

**Operation complete**

**Controlling the Internal Switch and DO**

The procedure below applies to internal switches when in the internal switch settings in system settings, Type is set to Manual.

The procedure below applies to DO channels whose Type is set to Manual in the range setting of DO channels.

In Display settings, under Screen display settings, Changing each value from monitoring must be set to On.

- 1 Tap the status display area of the internal switch that you want to control or the relay status display area of the relay that you want to use DO control.  
The area is expanded.
- 2 Tap the internal switch or relay you want to control.  
The internal switch information or channel information appears.
- 3 Tap **ON** or **OFF**.  
The tapped value (ON or OFF) takes effect.

**Operation complete**

### 2.3.8 Displaying the GX/GP System Information

You can display the GX/GP system information.  
You can view the measurement mode.

#### Procedure

- 1 Press **MENU**.  
The menu screen appears.
- 2 Tap the **Browse** tab and then **System information**.  
The system information appears.

#### When an Expandable I/O Is Not Installed

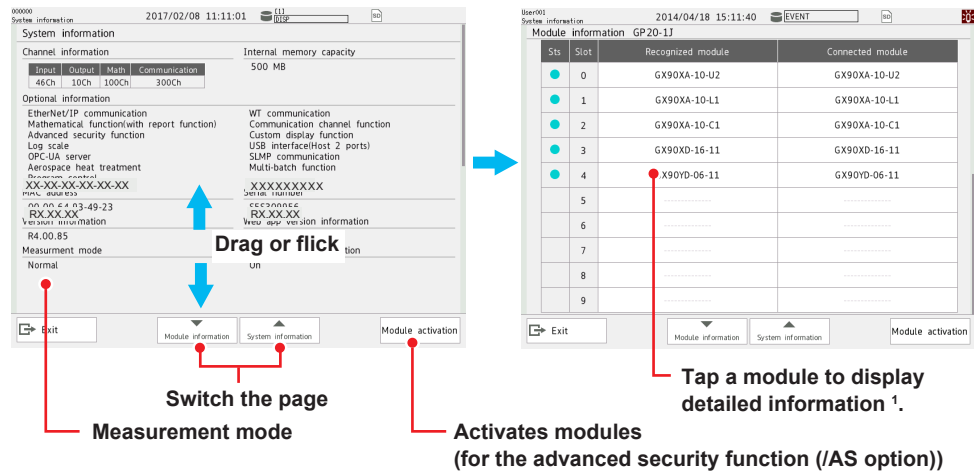

1 If the aerospace heat treatment (/AH option) is installed, a serial number is displayed in addition to the model name.

Drag or flick up and down to switch pages.

**When an Expandable I/O Is Installed**

System information Switch displays

System information 2017/02/08 11:43:30 DISP

System Info Unit Info Module Info

Channel information Internal memory capacity  
 Input Output Main Communication  
 72Ch 15Ch 100Ch 300Ch  
 500 MB

Optional information  
 Ethernet/IP communication WT communication  
 Mathematical function(with report function) Communication channel function  
 Advanced security function Custom display function  
 Log scale USB interface(Host 2 ports)  
 OPC-UA server SLMF communication  
 Aerospace heat treatment Multi-batch function  
 Max. address XXXXXXXXXX serial number  
 R4.00.85  
 Measurement mode Off  
 Normal

Exit

Unit information

User01 System information 2014/04/18 15:30:59 EVENT

System Info Unit Info Module Info

Sts	Unit	Recognized unit	Connected unit	Mod Sts
Main Unit: GP20-1J				
●	Main	GX90EX-02-TP1	GX90EX-02-TP1	▶
Extended Unit: GX60				
●	1	GX90EX-02-TP1	GX90EX-02-TP1	▶
	2	.....	.....	
	3	.....	.....	
	4	.....	.....	
	5	.....	.....	
	6	.....	.....	

Exit Module activation

Detailed information

Unit detail information

Version information R0.03.01  
 Serial number SP021847  
 Optional information  
 Error information None

Module status Tap to link to the corresponding unit on the Module Info tab.

Activates modules (for the advanced security function (/AS option))

Module information

User01 System information 2014/04/18 15:31:42 EVENT

System Info Unit Info Module Info

Unit Main	Unit 1	Unit 2	Unit 3	Unit 4	Unit 5	Unit 6
Sts	Slot	Recognized module	Connected module			
●	0	GX90XA-10-U2	GX90XA-10-U2			
●	1	GX90XA-10-L1	GX90XA-10-L1			
●	2	GX90XD-16-11	GX90XD-16-11			
	3	.....	.....			
	4	.....	.....			
	5	.....	.....			
	6	.....	.....			
	7	.....	.....			
	8	.....	.....			
●	9	GX90EX-02-TP1	GX90EX-02-TP1			

Exit Module activation

Detailed information

Module detail information

Number of channel 10  
 Version information R1.02.01  
 Serial number SSNA03627  
 Optional information  
 Error information None

































Switches units

Tap a module to display detailed information.

**Note**

If the expansion module is turned off and then back on, the connection status is changed. Close the screen once and open it again.

## Displayed Content

Item	Displayed Content	Details																						
System Info	<ul style="list-style-type: none"> <li>• Channel information</li> <li>• Internal memory capacity</li> <li>• Option information</li> <li>• MAC address</li> <li>• Serial number</li> <li>• Version information</li> <li>• Web application version information</li> <li>• Measurement mode</li> <li>• Advanced security function (/AS option) usage</li> </ul>	—																						
Unit Info (when an expandable I/O is installed)	<ul style="list-style-type: none"> <li>• Main unit model</li> <li>• Expandable I/O model</li> <li>• Expandable I/O status</li> </ul> <table border="1"> <thead> <tr> <th>Icon</th> <th>Description</th> </tr> </thead> <tbody> <tr> <td></td> <td>The expandable I/O is operating normally.</td> </tr> <tr> <td></td> <td>An error is occurring in the expandable I/O.</td> </tr> <tr> <td></td> <td>A critical error is occurring in the expandable I/O, and the unit is not operating.</td> </tr> <tr> <td></td> <td>The expandable I/O that is recognized does not match the unit that is connected. Examples: <ul style="list-style-type: none"> <li>• Connected but not recognized</li> <li>• Recognized but not connected</li> </ul> </td> </tr> <tr> <td>(Blank)</td> <td>No expandable I/Os are connected or recognized.</td> </tr> </tbody> </table> <ul style="list-style-type: none"> <li>• Expandable I/O number</li> <li>• Recognized expandable I/O models</li> <li>• Connected expandable I/O models</li> <li>• Status of modules in the expandable I/O</li> </ul> <table border="1"> <thead> <tr> <th>Icon</th> <th>Description</th> </tr> </thead> <tbody> <tr> <td></td> <td>The modules in the expandable I/O are operating normally.</td> </tr> <tr> <td></td> <td>An error is occurring in a module in the expandable I/O.</td> </tr> <tr> <td></td> <td>A discrepancy is occurring between a connected module in the expandable I/O and the module recognized by the system.</td> </tr> <tr> <td>(Blank)</td> <td>Information on the modules in the expandable I/O cannot be retrieved. Examples: <ul style="list-style-type: none"> <li>• No modules are connected to the expandable I/O.</li> <li>• The expandable I/O is not connected.</li> <li>• The expandable I/O is not operating normally, and the information on the modules in the unit cannot be retrieved.</li> </ul> </td> </tr> </tbody> </table>	Icon	Description		The expandable I/O is operating normally.		An error is occurring in the expandable I/O.		A critical error is occurring in the expandable I/O, and the unit is not operating.		The expandable I/O that is recognized does not match the unit that is connected. Examples: <ul style="list-style-type: none"> <li>• Connected but not recognized</li> <li>• Recognized but not connected</li> </ul>	(Blank)	No expandable I/Os are connected or recognized.	Icon	Description		The modules in the expandable I/O are operating normally.		An error is occurring in a module in the expandable I/O.		A discrepancy is occurring between a connected module in the expandable I/O and the module recognized by the system.	(Blank)	Information on the modules in the expandable I/O cannot be retrieved. Examples: <ul style="list-style-type: none"> <li>• No modules are connected to the expandable I/O.</li> <li>• The expandable I/O is not connected.</li> <li>• The expandable I/O is not operating normally, and the information on the modules in the unit cannot be retrieved.</li> </ul>	<ul style="list-style-type: none"> <li>• Version information</li> <li>• Serial number</li> <li>• Option information</li> <li>• Error information</li> </ul>
Icon	Description																							
	The expandable I/O is operating normally.																							
	An error is occurring in the expandable I/O.																							
	A critical error is occurring in the expandable I/O, and the unit is not operating.																							
	The expandable I/O that is recognized does not match the unit that is connected. Examples: <ul style="list-style-type: none"> <li>• Connected but not recognized</li> <li>• Recognized but not connected</li> </ul>																							
(Blank)	No expandable I/Os are connected or recognized.																							
Icon	Description																							
	The modules in the expandable I/O are operating normally.																							
	An error is occurring in a module in the expandable I/O.																							
	A discrepancy is occurring between a connected module in the expandable I/O and the module recognized by the system.																							
(Blank)	Information on the modules in the expandable I/O cannot be retrieved. Examples: <ul style="list-style-type: none"> <li>• No modules are connected to the expandable I/O.</li> <li>• The expandable I/O is not connected.</li> <li>• The expandable I/O is not operating normally, and the information on the modules in the unit cannot be retrieved.</li> </ul>																							
Module Info	<ul style="list-style-type: none"> <li>• Module status</li> </ul> <table border="1"> <thead> <tr> <th>Icon</th> <th>Description</th> </tr> </thead> <tbody> <tr> <td></td> <td>The module is operating normally.</td> </tr> <tr> <td></td> <td>An error is occurring in the module.</td> </tr> <tr> <td></td> <td>A critical error is occurring in the module, and it is not operating.</td> </tr> <tr> <td></td> <td>The module that is recognized does not match the module that is connected. Examples: <ul style="list-style-type: none"> <li>• Connected but not recognized</li> <li>• Recognized but not connected</li> </ul> </td> </tr> <tr> <td>(Blank)</td> <td>No modules are connected or recognized.</td> </tr> </tbody> </table> <ul style="list-style-type: none"> <li>• Slot number</li> <li>• Recognized module models</li> <li>• Connected module models</li> </ul>	Icon	Description		The module is operating normally.		An error is occurring in the module.		A critical error is occurring in the module, and it is not operating.		The module that is recognized does not match the module that is connected. Examples: <ul style="list-style-type: none"> <li>• Connected but not recognized</li> <li>• Recognized but not connected</li> </ul>	(Blank)	No modules are connected or recognized.	<ul style="list-style-type: none"> <li>• Number of channels</li> <li>• Version information</li> <li>• Serial number</li> <li>• Error information</li> </ul>										
Icon	Description																							
	The module is operating normally.																							
	An error is occurring in the module.																							
	A critical error is occurring in the module, and it is not operating.																							
	The module that is recognized does not match the module that is connected. Examples: <ul style="list-style-type: none"> <li>• Connected but not recognized</li> <li>• Recognized but not connected</li> </ul>																							
(Blank)	No modules are connected or recognized.																							

Operation complete**Activating Modules (When using the advanced security function (/AS option))**

If modules that need to be activated are installed, "Module activation" appears under the system information.

- ▶ For details on module activation, see section 2.2.8, "Activating Modules," in the Advanced Security Function (/AS) User's Manual (IM 04L51B01-05EN).

### 2.3.9 Displaying Network Information

You can display the GX/GP network information.

#### Procedure

- 1 Press **MENU**.  
The menu screen appears.
- 2 Tap the **Browse** tab and then **Network information**.  
The network information appears.

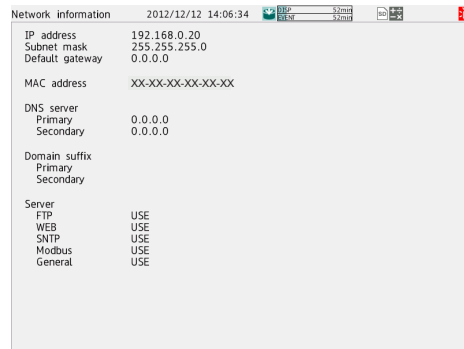

#### Operation complete

#### Display Item

The following items are displayed.

- IP address
- Subnet mask IP address
- Default gateway IP address
- MAC address
- DNS server IP addresses (primary and secondary)
- Domain suffixes (primary and secondary)
- Host name
- Domain name
- The usage conditions of the following server functions  
FTP, Web, Modbus, SNTP, GENE (general purpose communication), EtherNet/IP (/E1 option), OPC-UA (/E3 option), DARWIN  
When in use: USE  
When not in use: NOT

### 2.3.10 Displaying Reminders (/AH) (Release number 3 and later)

- ▶ See page 1-279 in section 1.32.4, "Displaying Reminders".



### 2.3.11 Listing the Log of Future Alarm Occurrences (Future Alarm Summary) (Release number 4 (Version 4.08) and later)

Displays information on the occurrence of future alarms.

#### Procedure

#### Future Alarm Summary Display

- 1 Press **MENU**.  
The menu screen appears.
- 2 Tap the **Browse** tab and then **Future alarm summary**.  
The future alarm summary appears.

Scroll

Number of summaries

Channel	Level	Type	ALM predicted time	Time remaining
Channel_001	1	H	2020/02/20 17:11:00	00m
Channel_002	2	L	2020/02/20 17:13:00	01m
Channel_003	3	h	2020/02/20 17:15:00	03m
Channel_004	4	l	2020/02/20 17:17:00	05m
Channel_101	1	H	2020/02/20 17:19:00	07m
Channel_102	2	L	2020/02/20 17:21:00	09m
Channel_103	3	h	2020/02/20 17:23:00	11m
Channel_104	4	l	2020/02/20 17:25:00	13m
Channel_105	1	H	2020/02/20 17:27:00	15m
Channel_106	2	L	2020/02/20 17:29:00	17m

Time remaining (Remaining time until alarm occurrence)

Alarm predicted time

Alarm type

Alarm level

Channels on which alarms are occurring

▲ Alarm occurrence

#### Operation complete

#### Scrolling the Future Alarm Display

You can scroll the display in the following manner.

- Drag or flick the data display area up or down.
- Scroll icons
  - UP: Scrolls the future alarm information up
  - Down: Scrolls the future alarm information down

### **Future Alarm Summary Display Function**

The future alarm summary displays only the future alarms that are currently occurring. Future alarm information is updated at the recording interval. At this time, all information before the update is deleted.

If the predicted future waveform does not appear (for example, when recording is stopped), no event appears in the future alarm summary.

### **Functions that Differ from the Normal Alarm Summary**

- Detailed information (alarm information) does not appear.
- You cannot switch to the historical trend screen.
- You cannot perform alarm save.
- You cannot switch the display mode (watch mode/list mode).
- Milli second (milliseconds) does not appear.
- You cannot register on the multi screen.
- There is no sort function. Displayed in ascending order of predicted time.

## 2.4 Executing Various Functions

This section explains how to execute various functions.

### 2.4.1 Releasing Alarm Output (Alarm ACK and individual alarm ACK operation)

This operation is valid when the GX/GP is configured as follows:

- In **System settings**, under **Alarm basic settings**, Indicator's **Hold/Nonhold** is set to **Hold**.
- Under **DO channel settings**, Action's **Hold** is set to **Hold** or **Relay Action on ACK** is set to **Reset**.
- In **Control settings**, under **Control alarm**, the relay action is not set to **Nonhold**.

#### Procedure

##### Acknowledging All Alarms

When an alarm acknowledge operation is carried out, the indicators and outputs (relays) of all activated alarms are cleared. However, there are cases in which they are not cleared depending on the settings. ► See the DO output relay operation figure in section 1.6, "Configuring DO Channels (Digital output channels)"  
All control alarm ACKs are also cleared at the same time.

You can carry out this procedure after an alarm occurs.

- 1 Press **MENU**.  
The menu screen appears.
- 2 Tap the **Alarm** icon.  
The alarm acknowledge confirmation screen appears.

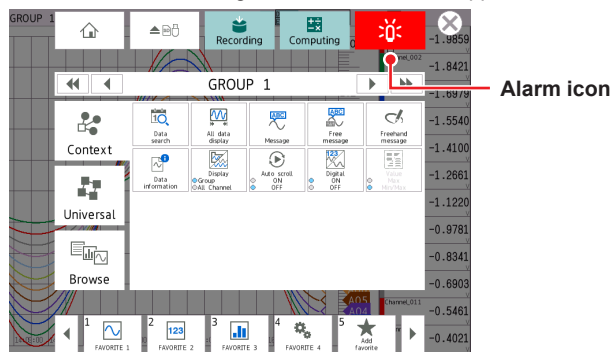

- 3 Tap **OK**.  
The alarm output is released.

Operation complete

### Acknowledging Individual Alarms (Release number 2 and later)

Active alarms are acknowledged separately by channel and level.

Even when Individual alarm ACK is specified, it is possible to acknowledge all alarms at once.

The individual alarm ACK function must be enabled. See page 1-207 in section 1.23.3, "Setting the Alarm Display Hold/Nonhold and Individual Alarm ACK Operation".

You can carry out this procedure after an alarm occurs.

- 1 Tap the digital display area of a channel.  
The channel information appears.

- 2 Tap the Alarm ACK icon.  
The individual alarm ACK selection screen appears.

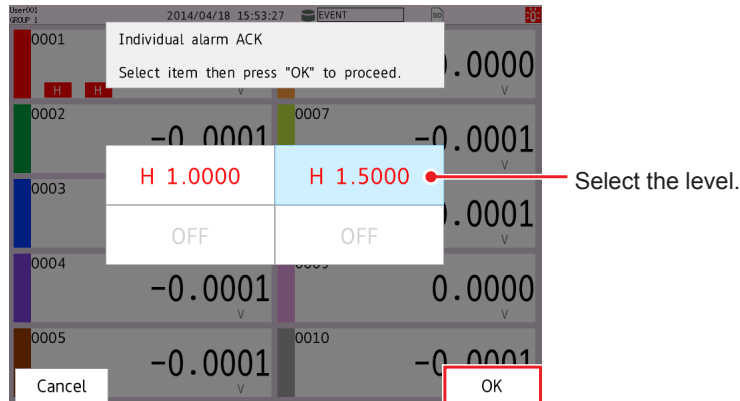

- 3 Select the level to acknowledge, and tap **OK**.  
The alarm output is released.

#### Operation complete

Individual alarm ACK can be executed from the following screens.

- Trend
- Digital
- Bar graph
- Overview
- Custom display

## 2.4.2 Disabling and Enabling Operation (Operation lock function)

- ▶ See page 2-87 in section 2.9, "Disabling Operation (Operation lock function)".

## 2.4.3 Resetting Timers (Relative timers)

### Procedure

- 1 Press **MENU**.  
The menu screen appears.
- 2 Tap the **Universal** tab and then **Timer reset**.  
The reset selection screen (timer number or all) appears.
- 3 Select the timer to reset, and tap **OK**.  
The timer is reset.

#### Operation complete

## 2.4.4 Resetting Match Time Timers

### Procedure

- 1 Press **MENU**.  
The menu screen appears.
- 2 Tap the **Universal** tab and then **Match time timer reset**.  
The reset selection screen (timer number or all) appears.
- 3 Select the match time timer to reset, and tap **OK**.  
The match time timer is reset.

Operation complete

## 2.4.5 Generating a Record Start Trigger for Event Data

- See page 2-6 in section 2.1.3, “Applying a Record Start Trigger for Event Data”.

## 2.4.6 Using, Registering, and Deleting Favorite Screens

You can register displays that you use frequently as favorite screens and display them with easy operation.  
You can register up to 20 displays.

### Procedure

#### Registering a Favorite Screen

- 1 Show the display that you want to register as a favorite screen.
- 2 Press **MENU**.  
The menu screen appears.

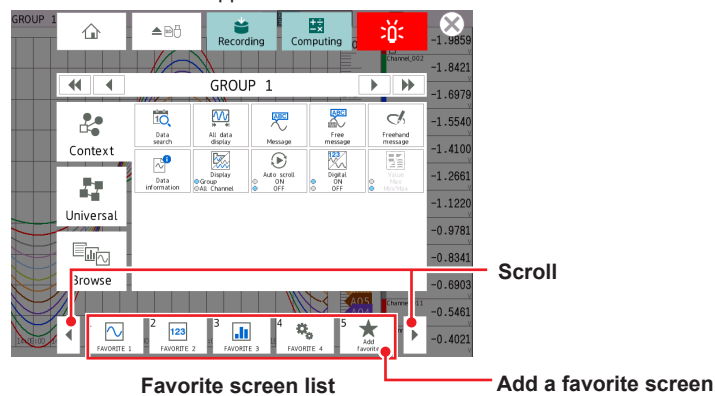

- 3 Tap **Add favorite**.  
The Add to favorite list screen appears.
- 4 Tap **Favorite name**, and enter the name.
- 5 Tap **OK**.  
The display is registered.
- 6 Tap the **Close** icon to close the menu screen.

Operation complete

### Deleting a Favorite Screen

- 1** Press **MENU**.  
The menu screen appears.
- 2** Tap the **Universal** tab and then **Remove favorite**.  
The Remove favorite list screen appears.
- 3** Select the screen to delete, and tap **OK**.  
The favorite screen is deleted.
- 4** Tap the **Close** icon to close the menu screen.

Operation complete

### 2.4.7 Performing a Test Print

- 1** Press **MENU**.  
The menu screen appears.
- 2** Tap the **Universal** tab and then **Test print**.  
A test print is performed.

Operation complete

### 2.4.8 Clearing the Buzzer Sound

- 1** Press **MENU**.  
The menu screen appears.
- 2** Tap the **Universal** tab and then **Buzzer ACK**.  
The buzzer sound (included warning sound) is cleared.

Operation complete

### 2.4.9 Adjusting the Clock Manually

- ▶ See page 2-82 in section 2.7.4, “Adjusting the Clock Manually (SNTP time adjustment)”.

### 2.4.10 Using the User Function Keys (Release number 2 and later)

You must configure the event action function.

- ▶ For details on the settings, see page 1-162 in section 1.19, “Configuring the Event Action Function”.

- 1** Press **MENU**.  
The menu screen appears.
- 2** Tap the **Universal** tab and then **User function 1** or **User function 2**.  
The action assigned to the key is executed.

Operation complete

### 2.4.11 Verifying Unverified Certificates (Release number 2 and later)

If a certificate that you have fails verification and FTP transfer or mail transmission is not possible, an error message (E782) appears, and a Unverified certificate icon appears in the Universal menu.

FTP transfer or mail transmission will not be possible until a verification confirmation is performed, a root certificate is installed, or other appropriate measure is taken.

When verification confirmation is performed, data that was not transmitted will be transmitted in the next transmission opportunity.

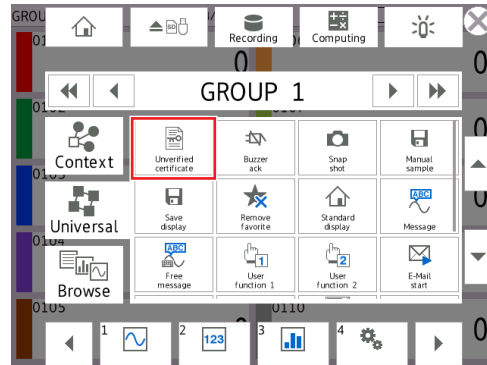

#### Procedure

- 1 Press **MENU**, tap **Universal** and then **Unverified certificate**.  
A Select unverified certificate screen appears.
- 2 From the available buttons, tap the server to display the certificate information.  
The certificate information appears, and you will be prompted to install a root certificate or confirm the certificate.
- 3 Check the information, and tap **OK**.  
Clicking Cancel aborts the procedure and the Select unverified certificate screen closes.

#### Operation complete

#### Certificate Information

Item	Description
Validity	OK or not OK
Verification	OK or not OK
Issuer	Name of the issuer
Subject	Subject
Valid not before	Start date and time of validity
Valid not after	End date and time of validity
Hash value (SHA1)	Hash value

### 2.4.12 Resetting the Calibration Reminder Due Date, Performing Calibration Correction (/AH) (Release number 3 and later)

- ▶ See page 1-276 in section 1.32.3, "Resetting the Calibration Reminder Due Date, Performing Calibration Correction".

## 2.5 Saving Various Types of Data

This section explains how to save various types of data.

### Note

In the storage medium for saving data, do not place a file with the same name as the directory name ("DATA0" by default) specified for the save destination directory on "page 1-141 in section 1.14.1, "Setting the Save Directory, File Header, and File Name".

### 2.5.1 Automatically Saving Measured Data

Measured data is saved automatically when in **Data save settings**, Media save **Auto save** is set to **On**.

The save destination is an SD memory card.

Have an SD memory card inserted in the slot at all times. While recording, the measured data recorded in the internal memory is automatically saved to the SD memory card.

Behavior when Media FIFO is not enabled: If data storage to the storage medium is not complete such as due to insufficient free space, the unsaved data is saved the next time the data is automatically saved.

### 2.5.2 Manually Saving Measured Data (Collectively saving unsaved data)

Manual saving of measured data is possible when in **Data save settings**, Media save **Auto save** is set to **Off**.

The save destination is an SD memory card or USB flash memory (/UH option). The procedure below is for saving unsaved data to an SD memory card.

#### Procedure

- 1** Set an SD memory card in the slot.  
The media operation screen appears.
- 2** Tap **Save manual**.  
The unsaved data in the internal memory is saved to the SD memory card.
- 3** Remove the SD memory card by following the procedure below.  
Tap the **MENU** key > **Media eject** icon > **SD**.  
When the message "Media can be removed safely" appears, remove the SD memory card.

#### Operation complete

- ▶ For details on manually saving from the memory summary, see page 2-47 in section 2.3.3, "Displaying a List of Data Files in the Internal Memory and Saving Data (Memory summary)".

### Note

- If there is not enough space on the storage medium, the message "Not enough free space on media" appears, and the data is not saved. If this message appears, replace the storage medium. Then, carry out the procedure again.
- You cannot abort a data save operation while it is in progress.



### 2.5.3 Manually Saving Instantaneous Values of Measured Data (Manual sample)

This section explains how to save the instantaneous values of channels whose manual sample recording is enabled (excluding those set to Skip or Off) through touch operation.

#### Procedure

- 1 Press **MENU**.  
The menu screen appears.
- 2 Tap the **Universal** tab and then **Manual sample**.  
Manual sampling is executed.

Operation complete

#### Explanation

##### Number of Manual Sampled Data Entries in the Internal Memory

You can view the number of manual sampled data entries in the internal memory on the memory summary display (▶ see page 2-47 in section 2.3.3, “Displaying a List of Data Files in the Internal Memory and Saving Data (Memory summary)”).

##### Saving Manual Sampled Data

- If auto save is **On**, the manual sampled data is saved to the SD memory card when you carry out manual sampling.
- You can save the manual sampled data to the SD memory card or USB flash memory (/UH option) by following the procedure for manually saving the data (▶ see page 2-75 in section 2.5.3, “Manually Saving Instantaneous Values of Measured Data (Manual sample)”) regardless of the Auto save setting.
- When the measurement mode is set to Dual interval, manual sampling operates at the scan interval of the scan group set with the master scan interval.  
Channels running at different scan intervals can be registered to a recording channel, but the latest values when processing is performed are saved.

### 2.5.4 Saving and Printing Screen Image Data (Snapshot)

This section explains how to save the screen image data of the active display to an SD memory card or USB flash memory (/UH option). This operation is called snapshot, and the screen image data file is called snapshot data file. The screen image data can also be printed. To use these functions, you need to set Snapshot to On under Printer settings in System settings. See page 1-213 in section 1.23.7, “Setting the Printer Output Conditions”. If the auto transferring of snapshots is set to On for the FTP client function, the data is transferred via FTP.

#### Procedure

- 1 Press **MENU**.  
The menu screen appears.
- 2 Tap the **Universal** tab and then **Snap shot**.  
If both an SD memory card and USB flash memory are inserted, a screen for selecting the save destination appears. If only one of the two is inserted, the screen does not appear, and the snapshot data file is saved to the inserted medium.
- 3 Tap the save destination.  
The snapshot data file is saved to the SD memory card or USB flash memory.  
If you are taking a snapshot through touch operation, the menu screen and pop-up screen are not saved. If you are taking a snapshot through a communication command or event action, all displayed contents are saved.

Operation complete

- Snapshot data files are in PNG format.
- ► For file names, see page 1-141 in section 1.14.1, “Setting the Save Directory, File Header, and File Name”.

**Note**

Note that if you take a snapshot, you will not be able to take another snapshot for approximately 10 seconds.

If you are taking a snapshot through a communication command or event action, the snapshot data file is saved to the SD memory card.

### 2.5.5 Saving Internal Memory Files to an SD Memory Card or USB Flash Memory

- See page 2-47 in section 2.3.3, “Displaying a List of Data Files in the Internal Memory and Saving Data (Memory summary)”.

### 2.5.6 Saving Display Data or Event Data during Recording through Touch Operation

The save destination is the SD memory card in the GX/GP.  
You can carry out this procedure when display data or event data is being recorded in **Free** mode. Unsaved measured data is saved to the SD memory card.  
When the measurement mode is Dual interval, measurement groups are saved simultaneously.

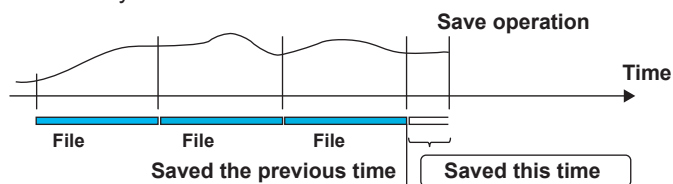

**Procedure**

- 1** Press **MENU**.  
The menu screen appears.
- 2** Tap the **Universal** tab.  
The menu screen appears.
- 3** Tap **Save display** or **Save event**.  
The display data or event data is saved to the SD card.

Operation complete

## 2.5.7 Removing the SD Memory Card or USB Flash Memory

### Procedure

- 1 Press **MENU**.  
The menu screen appears.
- 2 Tap the **Media eject** icon.  
A confirmation screen is displayed.

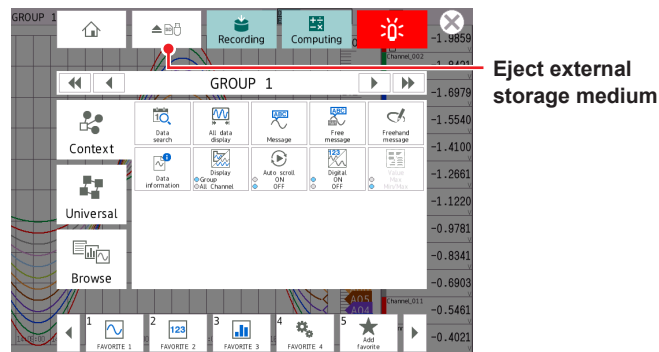

Eject external storage medium

- 3 Tap **SD** or **USB**.  
You can now remove the SD memory card or USB flash memory.

### Operation complete

### Note

If you remove the SD memory card or USB flash memory without performing the above procedure, the data stored on it may be damaged.

### Explanation

#### Operations That You Can Perform on an SD Memory Card or USB Flash Memory

You can perform the following data save/load and file operations.

Save and load setting parameter files (▶ see page 1-226 in section 1.25.1, “Loading Setting Parameters”, page 1-240 in section 1.26.1, “Saving the Setting Parameters”)

Save display data and event data files (▶ see page 2-47 in section 2.3.3, “Displaying a List of Data Files in the Internal Memory and Saving Data (Memory summary)”)

Load display data and event data files (▶ see page 2-85 in section 2.8.2, “Loading and Displaying the Measured Data (Display data and event data) from the Storage Medium”)

List files and delete files (▶ see page 1-249 in section 1.27, “Listing Files That Are on the External Storage Medium”)

Format (▶ see page 1-250 in section 1.28, “Formatting the External Storage Medium”)

## 2.6 Using USB Peripheral Devices

This section explains how to connect peripheral devices to USB ports (/UH option).

### 2.6.1 Using a Keyboard or Bar Code Reader

You can connect a keyboard or bar code reader to a USB port.

- ▶ For specifying the keyboard or bar code reader to use, see page 1-216 in section 1.23.11, “Setting USB Input Devices (/UH option)”.

#### Procedure

##### Connecting a Keyboard or Bar Code Reader

Connect a keyboard or bar code reader to the GX/GP USB port.

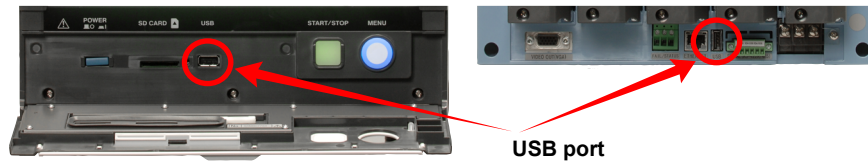

##### Removing the Keyboard or Bar Code Reader

Disconnect the keyboard or bar code reader from the GX/GP USB port.

#### Note

- You can connect and disconnect a keyboard or bar code reader at any time, regardless of what is shown on the display and whether the GX/GP is on or off.
- You can connect only one keyboard or one bar code reader to the GX/GP. You cannot use a keyboard and a bar code reader at the same time.
- Use a keyboard that matches the USB input device setting.
- The CapsLock key state is cleared when the power is turned off and then on or when the USB keyboard is disconnected.
- The NumLock key is always enabled regardless of the keyboard state.

## Operating from a Keyboard

When a text input keyboard is showing on the GX/GP screen, you can enter alphabet characters, numbers, and symbols from the connected keyboard.

### Valid Keys

Keys enclosed in frames are valid.

#### PC 104 Keyboard (US)

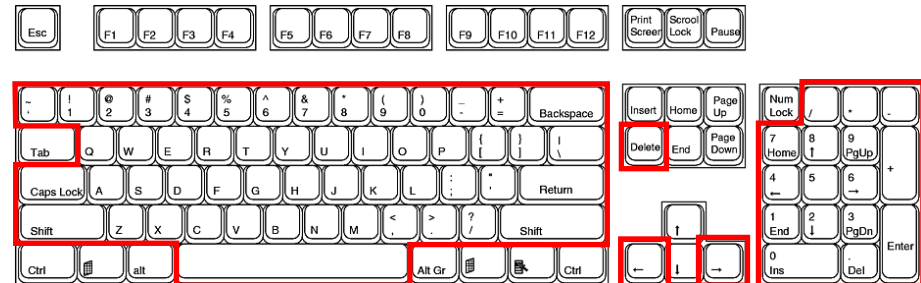

#### PC 109 Keyboard (Japanese)

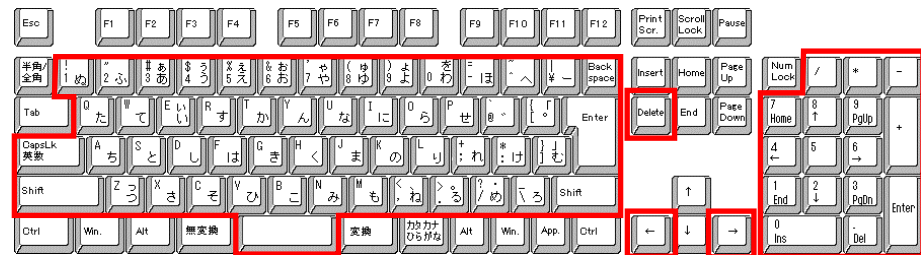

## Operating from a Bar Code Reader

When a text input keyboard is showing on the GX/GP screen, you can enter alphabet characters, numbers, and symbols that the connected bar code reader reads. ASCII characters (128 characters: numbers, symbols, and uppercase and lowercase alphabet characters) can be read.

- **Configuring the Bar Code Reader**

Configure the bar code reader as follows:

USB Host Parameter	Setting
USB device type	HID keyboard simulation
USB keyboard type	Set the type in accordance with the GX/GP USB input device setting. <ul style="list-style-type: none"> <li>• When the GX/GP setting is US keyboard (104) Bar code reader: Standard US USB keyboard</li> <li>• When the GX/GP setting is Japanese keyboard (109) Bar code reader: Japanese Windows (ASCII)</li> </ul>

- **How to Use**

Follow the operating procedure of the bar cord reader that you are using.

## 2.6.2 Using a Mouse

You can use a mouse simply by connecting it to a USB port.

### Mouse Operation

Tap: Click the left button

Drag: Drag while holding down the left button

Display the menu: Click the center button (mouse wheel)

### 2.6.3 Executing Communication Commands with a USB Bar code Reader (Release number 2 and later)

You can execute communication commands from a USB bar code reader. You need to set USB input device to Bar-code reader.

Input from the keyboard is also executed as a communication command.

- ▶ For details on the commands that you can set and execute, see page 1-216 in section 1.23.11, "Setting USB Input Devices (/UH option)".

- **Configuring the Bar Code Reader**

Configure the bar code reader as follows:

USB Host Parameter	Setting
USB device type	HID keyboard simulation
USB keyboard type	Set the type in accordance with the GX/GP USB input device setting. <ul style="list-style-type: none"><li>• When the GX/GP setting is Bar-code reader Bar code reader: US standard USB keyboard</li></ul>

## 2.7 Performing Network Related Operations

This section explains how to perform network related operations.

### 2.7.1 Performing an Mail Transmission Test

You can send a test mail to check whether you have configured the mail settings correctly.

#### Procedure

- 1 Press **MENU**.  
The menu screen appears.
- 2 Tap the **Universal** tab and then **E-Mail test**.  
The mail transmission test screen appears.
- 3 Tap **Recipient 1** or **Recipient 2**.  
A test mail is sent.

[Operation complete](#)

### 2.7.2 Starting and Stopping Mail Transmission

You can enable or disable the mail transmission function.

#### Procedure

#### Starting Mail Transmission

- 1 Press **MENU**.  
The menu screen appears.
- 2 Tap the **Universal** tab and then **E-Mail start**.  
Mail transmission function is enabled.

[Operation complete](#)

#### Stopping Mail Transmission

- 1 Press **MENU**.  
The menu screen appears.
- 2 Tap the **Universal** tab and then **E-Mail stop**.  
Mail transmission function is disabled. Unsent mails are cleared.

[Operation complete](#)

#### Mail Retransmission

If mail transmission fails, the message is retransmitted up to twice at 30-second and 1-minute intervals.

If retransmission fails, the message is discarded.

### 2.7.3 Checking FTP File Transfers (FTP transmission test)

You can check whether files can be sent from the GX/GP to the FTP server using a test file.

#### Procedure

- 1** Press **MENU**.  
The menu screen appears.
- 2** Tap the **Universal** tab and then **FTP test**.  
The FTP transmission test screen appears.
- 3** Tap **Primary** or **Secondary**.  
The test file is sent.

#### Operation complete

#### Items to Check before Performing This Test

- Connect the Ethernet cable correctly. ► For the connection procedure, see section 3.6, “Optional Terminal Wiring” in the First Step Guide.
- Check that the Ethernet interface settings are correct. ► For the setup procedure, see page 1-182 in section 1.21, “Configuring the Ethernet Communication Function”.

#### Checking the Results of the FTP Test

- When an FTP test is executed, a test file named FTP\_TEST.TXT is transferred to the specified FTP destination directory.
- You can also check the result of an FTP test using the FTP log (► see page 2-53 in section 2.3.5, “Displaying Logs”), Web display (► see section 3.1, “Using the Web Application to Change the GX/GP Settings, Monitor Data, and Control the GX/GP (Web server function)”), and FLog command (see the setting commands in the communication command manual).

### 2.7.4 Adjusting the Clock Manually (SNTP time adjustment)

You can adjust the clock manually through touch operation. The SNTP client must be enabled.

- For details on the SNTP function, see page 1-190 in section 1.21.5, “Setting the SNTP Client Function”.

#### Procedure

- 1** Press **MENU**.  
The menu screen appears.
- 2** Tap the **Universal** tab and then **SNTP**.  
The clock is adjusted.

#### Operation complete



## 2.7.5 Outputting Snapshots or Report Data to a Network Printer

You can output snapshots or report data to a network printer.

To enable snapshot output, you need to set **Snapshot** to **On** under **Printer settings** in **System settings**.

To enable report data output, you need to set Report Template Output **Printer** to **On** under **Basic settings** in **Report Settings**.

### Procedure

#### Outputting a Snapshot

- 1 Press **MENU**.  
The menu screen appears.
- 2 Tap the **Universal** tab and then **Snap shot**.  
A snapshot is output to a network printer.

[Operation complete](#)

#### Outputting Reports

When report data is generated, it is automatically output to the printer.

## 2.7.6 Displaying Network Connection Information

- ▶ See page 2-66 in section 2.3.9, “Displaying Network Information”.

## 2.7.7 Obtaining and Releasing Network Information Received through DHCP

You can manually obtain or release network information such as the IP address. You can carry out this procedure when **Obtain IP address automatically** is set to **On**. You will show the network information screen and then obtain or release information.

### Procedure

#### Obtaining Network Information

- 1 Press **MENU**.  
The menu screen appears.
- 2 Tap the **Browse** tab and then **Network information**.  
The network information appears.
- 3 Press **MENU**.  
The menu screen appears.
- 4 Tap the **Context** tab and then **Request IP address**.  
The obtained IP address is displayed.

[Operation complete](#)

### Releasing Network Information

- 1** Press **MENU**.  
The menu screen appears.
- 2** Tap the **Browse** tab and then **Network information**.  
The network information appears.
- 3** Press **MENU**.  
The menu screen appears.
- 4** Tap the **Context** tab and then **Release IP address**.  
The network information is released.

Operation complete

## 2.8 Performing File Operations

This section explains file operations.

### 2.8.1 Initializing the Internal Memory

You can initialize the settings. When you initialize the settings, the internal memory data is also initialized.

- ▶ For the procedure, see page 1-251 in section 1.29.1, “Initializing the Settings and the Internal Memory”.

### 2.8.2 Loading and Displaying the Measured Data (Display data and event data) from the Storage Medium

This section explains how to load display data or event data from the external storage medium and display it as waveforms. The loaded data is shown on the historical trend display.

- ▶ For details on operating the historical trend display, see page 2-31 in section 2.2.7, “Displaying Previously Measured Data (Historical trend display)”.

#### Procedure

- 1** Press **MENU**.  
The menu screen appears.
- 2** Tap the **Browse** tab and then **Save load**.  
The menu screen appears.
- 3** On the menu, Tap **Load display data** or **Load event data**.
- 4** Tap **Media kind** and then **SD** or **USB**.
- 5** Tap **Select file**, select the file, and tap **OK**.
- 6** Tap **Execute**.  
The file is loaded and shown in the historical display.

#### Operation complete

#### Note

- The extensions to display data files and event data files vary depending on whether the advanced security function (/AS option) is installed and whether the function is enabled or disabled.

Advanced Security Function	Display Data File	Event Data Files
Not available or disabled	.GDS	.GEV
Enabled	.GSD	.GSE

- You can sort the files by file name, directory name, or update date/time.
- A data file recorded in Dual interval mode contains only a single type of measurement group. Data of measurement groups that are not recorded is not displayed.

### 2.8.3 Formatting the External Storage Medium

Formatting will remove the contents of the storage medium.

If the advanced security function (/AS option) is installed, external storage media cannot be formatted.

#### Procedure

- 1** Press **MENU**.  
The menu screen appears.
- 2** Tap the **Browse** tab and then **Save load**.  
The menu screen appears.
- 3** Tap Format **Media kind** and then **SD** or **USB**.
- 4** Tap **Volume name**, and set the volume name.
- 5** Tap **Execute**.  
A confirmation screen is displayed.
- 6** Tap **OK**.  
The message "Execution is complete." will appear. Tap the **Close** icon to close.
- 7** Tap **Exit**.  
The GX/GP returns to the original screen.

Operation complete

## 2.9 Disabling Operation (Operation lock function)

This section explains how to disable operation.

You need to set Security function **Touch operation** to **Operation Lock** under **Basic settings** in **Security settings**.

This operation is not possible when you are using the advanced security function (/AS option).

### 2.9.1 Locking the Operation

- 1 Press **MENU**.  
The menu screen appears.
- 2 Tap the **Universal** tab and then **Open lock Lock/Unlock**.  
The operation lock is enabled. The operation lock icon is displayed in the status display section.

### 2.9.2 Releasing the Operation Lock

- 1 Press **MENU**.  
The menu screen appears.
- 2 Tap the **Universal** tab and then **Open lock Lock/Unlock**.  
The screen for entering a password appears.

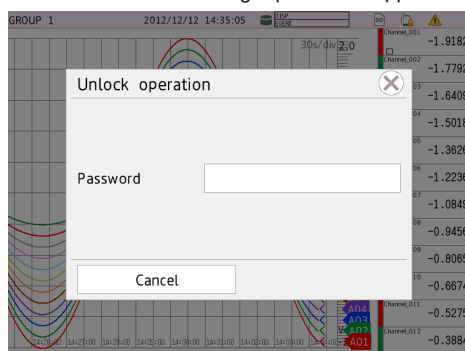

3. Enter the password, and then tap **OK**.  
The operation lock is released. The operation lock icon disappears from the status display section.  
The password that you enter is displayed as a string of asterisks.

Operation complete

## 2.10 Allowing Only Registered Users to Operate

This section explains security related operations.

If you are using the advanced security function (/AS option), see section 2.3, "Logging In and Out," in the Advanced Security Function (/AS) User's Manual (IM 04L51B01-05EN).

### 2.10.1 Logging In and Logging Out

This section explains how to log in through touch operation.

For the procedure to log in via communication, see the *Communication Interface User's Manual*, IM04L51B01-17EN.

#### Procedure

##### Logging In

- 1 Press **MENU**.  
The menu screen appears. If **Operation without Login** is set to **OFF**, a password input screen will appear.
- 2 Tap the **Universal** tab and then **Login**.  
The screen for entering a password appears.

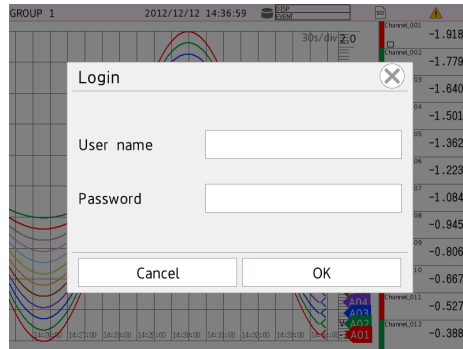

3. Enter the user name and password, and then tap **OK**.  
You can now operate the GX/GP. The user name is displayed in the status display section. The password that you enter is displayed as a string of asterisks.  
  
The first time you log in, the password is set to the default password.  
You can set the password after you log in.  
▶ For the setting procedure, page 2-89 in section 2.10.2, "Changing the Password".
- 4 Tap the **Close** icon to close the menu screen.

#### Operation complete

##### Default User Names and Password

User Number	User Name	Password
1	User01	default
2	User02	
:	:	
50	User50	

## Logging Out

- **Using Touch Operation**

- 1** Press **MENU**.  
The menu screen appears.
- 2** Tap the **Universal** tab and then **Logout**.  
You are logged out. The user name disappears from the status display section.

Operation complete

- **Auto Logout**

If auto logout is enabled, you will be logged out when there is no key or touch operation for the specified length of time.

## 2.10.2 Changing the Password

You can carry out this procedure when in **Security settings**, under **Basic settings**, Security **Touch operation** is set to **Login**.

### Procedure

- 1** Press **MENU**.  
The menu screen appears. If **Operation without Login** is set to **OFF**, a password input screen will appear.
- 2** Tap the **Universal** tab and then **Change password**.  
The screen for changing the password appears.
- 3** Tap **Old Password**, and enter the old password.
- 4** Tap **New Password**, and enter the new password.
- 5** Tap **New Password Again**, and enter the new password.
- 6** Tap **OK**.  
The screen closes, and the new password takes effect.
- 7** Tap the **Exit** icon to close the menu screen.

Operation complete

### Note

Default password: default  
For the default password when you are using the advanced security function (/AS option), see section 2.3.1, "Logging In," in the Advanced Security Function (/AS) User's Manual (IM 04L51B01-05EN).

---

Blank



# 3.1 Using the Web Application to Change the GX/GP Settings, Monitor Data, and Control the GX/GP (Web server function)

## 3.1.1 Connecting to a Network

### Configuring the GX/GP for Network Connection

To connect the GX/GP to an Ethernet network, you need to configure the GX/GP in accordance with the network environment. For the configuration procedure, see page 1-182 in section 1.21, "Configuring the Ethernet Communication Function"

### Connecting an Ethernet Cable



Do not connect an Ethernet cable whose plug does not comply with FCC specifications. Doing so may damage the GX/GP.

Connect an Ethernet cable from your network to the Ethernet port on the GX/GP rear panel. The figure below shows the position of the Ethernet port on the GX20.

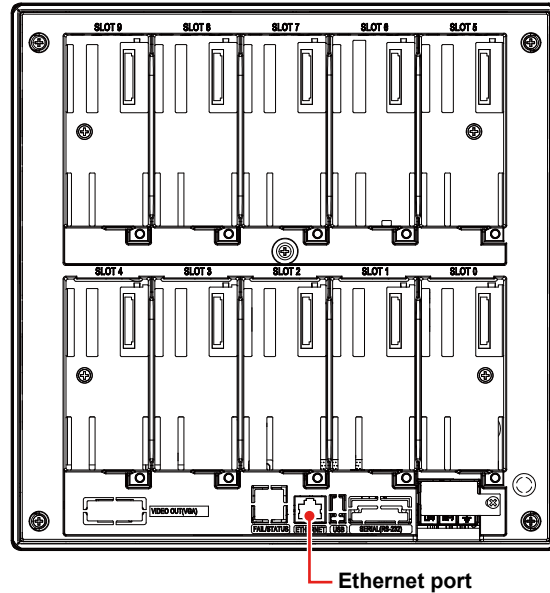

### 3.1.2 Starting and Closing the Main Application

#### Functional Overview

You can use the main application (hereafter referred to as the Web application) to do the following:

- Control the GX/GP
- Monitor data
- Change settings

There is no need to install the Web application. Specify the GX/GP IP address on the Web browser to display the application screen. If a GX/GP is accessed from multiple browsers simultaneously, the Web application performance may degrade.

You can access a single GX/GP from multiple browsers at once.

#### PC System Requirements

The system requirements are shown below.

##### Hardware

Item	Specifications
CPU	Windows 7 (32 bit edition) Intel Pentium IV, 3 GHz or faster x64 or x86 processor
	Windows 7 (64 bit edition) Intel Pentium IV, 3 GHz or faster x64 processor
	Windows 8.1
Internal memory	2 GB or more
Hard disk	100 MB or more free space; NTFS recommended
Printer	Printer compatible with the OS
Mouse	Mouse compatible with the OS
Display	A video card compatible with the OS and a display that has a resolution of 1024×768 or higher, and that can show 65,536 colors (16-bit, high color) or more
Communication ports	Ethernet port compatible with the OS and TCP/IP protocol

##### OS

Windows 7	Home Premium SP1 (32- or 64-bit edition) Professional SP1 (32- or 64-bit edition)
Windows 8.1	Update (32- or 64-bit edition) Pro Update (32- or 64-bit edition)
Windows 10	Home (32- or 64-bit edition) Pro (32- or 64-bit edition) Enterprise (32- or 64-bit edition) Enterprise LTSC (32- or 64-bit edition)

Yokogawa will also stop supporting OSs that Microsoft Corporation no longer supports.

##### Web browser

Internet Explorer 11

Google Chrome

Depending on the CPU, Application behavior may be delayed while displaying trend in Internet Explorer 11.

In that case, using Google Chrome may improve it.

#### GX/GP Configuration

Set the GX/GP's HTTP server function to **On**. For the procedure, see page 1-196 in section 1.21.9, "Setting the Server Functions to Use (FTP, HTTP, SNMP, MODBUS, GENE, DARWIN compatible communication)"

### Starting the Web Application

If a message appears in the information bar or dialog box when you start or while you are using the Web application, see the note on the next page.”

#### Procedure

- 1 Start the Web browser.
- 2 In the Address box, enter “http://” followed by the GX/GP IP address and press the Enter key. If DNS is available, you can specify the host name in place of the IP address.
  - Example 1: When the IP address is “127.1.1.1,” enter the following in the Address box.  
http://127.1.1.1
  - Example 2: If the HTTP server port has been changed from its default value (80) to “1024,” enter a colon after the IP address and then the port number.  
http://127.1.1.1:1024
  - Example 3: If the HTTP server encryption is set to on  
https://127.1.1.1
  - Example 4: If the HTTP server encryption is set to on and the port is changed from the default value of 443 to 1024  
https://127.1.1.1:1024

The Web application starts, and the screen appears. If the login function is enabled, a user authentication dialog box appears. Proceed to step 3.

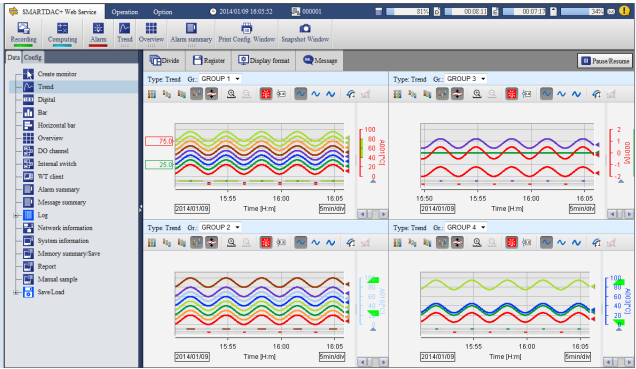

- 3 Enter the correct user name and password, and click **OK**. The Web application starts, and the screen appears.

#### Start Screen

The Web application starts with the default display conditions or the display conditions that were in use when the application was closed the previous time (see “Closing the Web Application”). For a description of the window, see “Screen” on page 3-6

### 3.1 Using the Web Application to Change the GX/GP Settings, Monitor Data, and Control the GX/GP (Web server function)

#### Note

- If the GX/GP login function is changed while the Web application is in use, you may need to reload the page or restart the browser. Follow the instructions in the message.
- This application is signed with an electronic signature. When the application starts, it automatically connects to the Internet and checks if the electronic signature has been revoked. As such, it may take several minutes for the application to start. To disable the electronic signature revocation check, configure your PC as follows.  
Control Panel > Java > **Advanced** tab > **Perform certificate revocation checks on** > **Do not check**
- If you cannot connect from Internet Explorer 10 or Internet Explorer 11 to a GX/GP whose login function is in use, disable the Enhanced Protection Mode of Internet Explorer. Click the **Tools** button (gear icon) > **Internet options** > **Advanced** tab, and clear the **Enable Enhanced Protection Mode** check box. Restart the PC, and then start the Web application.
- In some cases, immediately after you try to start the Web application, Internet Explorer displays a message "A problem with this webpage caused Internet Explorer to close and reopen the tab." Then it reloads the webpage several times, and finally displays "We were unable to return you to your webpage," preventing the Web application from starting. If this happens, delete the temporary Internet files of Internet Explorer, and try connecting again.  
Click the tool button (gear icon), Internet Options, the General tab, and then Delete under Browsing history. Select the Temporary Internet files and website files check box, and click Delete. Then, close the Web browser, restart it, and then start the Web application.
- During operation, a message generated by the Web application or the GX/GP may appear. For details on these messages, see page 5-24 in section 5.2.1, "Messages"



- If the display updating on the monitor screens slows down or stops, decrease the number of monitors displayed simultaneously.

3.1 Using the Web Application to Change the GX/GP Settings, Monitor Data, and Control the GX/GP (Web server function)

- Messages may appear in the information bar or dialog box. The possible messages and how to handle them are provided below.

Message	Corrective Action
To help protect your security, Internet Explorer stopped this site from installing an ActiveX control on your computer. Click here for options...	Click the information bar, and select <b>Install ActiveX Control</b> .
	
Internet Explorer - Security Warning Windows has blocked this software because it can't verify the publisher. Name: liked file name (see the table below) Your security settings do not allow Web sites to use ActiveX controls installed on your computer. This page may not display correctly. Click here for options...	Click <b>Internet Options &gt; Security &gt; Internet/Local intranet &gt; Custom Level &gt; ActiveX controls and plug-ins</b> , and then select the <b>Prompt</b> check boxes for <b>Download signed ActiveX controls</b> and <b>Download unsigned ActiveX controls</b> .
An add-on for this website failed to run. Check the security settings in Internet Options for potential conflicts.	

**Closing the Web Application**

When close the browser, the Web application also closes.

**Display Condition Storage and the Application of the Display Conditions the Next Time the Application Starts**

When the Web application closes, the display conditions are saved to the GX/GP. If the login function is enabled, the display conditions that are in use when the Web application is closed are saved for each user.

The next time the Web application starts, it will apply the display conditions saved in the GX/GP. If the GX/GP configuration has been changed and it conflicts with the saved display conditions, the default display conditions will be used.

3.1 Using the Web Application to Change the GX/GP Settings, Monitor Data, and Control the GX/GP (Web server function)

Screen

The screen configuration is shown below.

**Note**

Set the browser's zoom (on the **View** menu, click **Zoom**) to 100%. Otherwise, the layout may appear crooked.

Menu bar

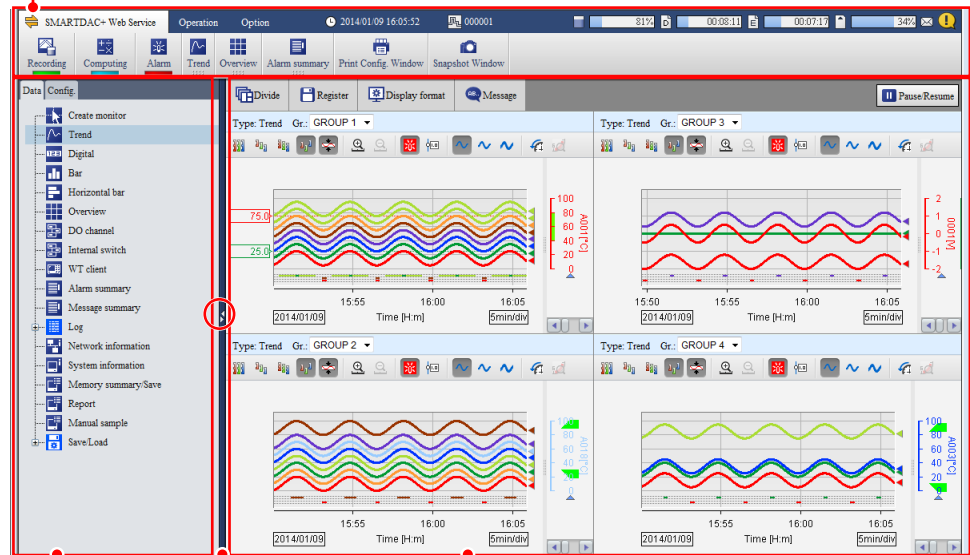

Content selection tree

Split bar

Content area

Name	Description
Menu bar	Consists of three tabs: <b>SMARTDAC+ Web Service</b> , <b>Operation</b> , and <b>Option</b> . You can show or hide the menu (button) area by double-clicking the tab.
Content selection tree	Used to select the contents to display in the content area. There are two tabs: <b>Data</b> and <b>Config</b> .
Content area	Area for displaying content.
Split bar	Drag the split bar to change the panel width of the content selection tree and content area. While you drag the split bar, the content area displays an alternate screen (see the note on page 3-11 ). Click the show/hide button (indicated with a red circle) to show or hide the content selection tree.

**Status Indications**

The menu bar shows the GX/GP status.

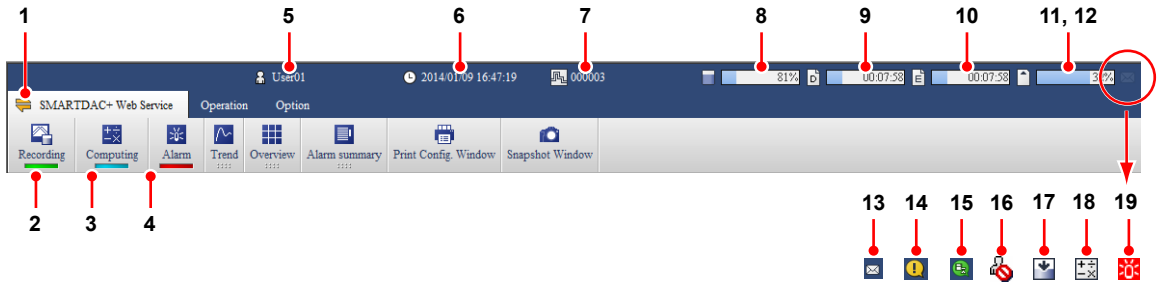

Number	Description																	
1	Communication status. Turns on in yellow when communication with the GX/GP is normal. If you move the mouse pointer over the icon and hold it there for about 1 second, "Normal" or "Error" will appear in a pop-up window. If communication with the GX/GP is disconnected or recovers, a bubble message indicating the condition will appear for a few seconds.																	
2	Recording status. Turns on in green when recording.																	
3	Indicates the computation status of computation channels. <table border="1"> <thead> <tr> <th>Status</th> <th>Description</th> </tr> </thead> <tbody> <tr> <td>Off</td> <td>Computation stopped.</td> </tr> <tr> <td>Blinking yellow</td> <td>Computation stopped with error.</td> </tr> <tr> <td>Blue</td> <td>Computing.</td> </tr> <tr> <td>Alternating blue and yellow</td> <td>Computing with error.</td> </tr> </tbody> </table>	Status	Description	Off	Computation stopped.	Blinking yellow	Computation stopped with error.	Blue	Computing.	Alternating blue and yellow	Computing with error.							
Status	Description																	
Off	Computation stopped.																	
Blinking yellow	Computation stopped with error.																	
Blue	Computing.																	
Alternating blue and yellow	Computing with error.																	
4	Alarm status. <table border="1"> <thead> <tr> <th>Status</th> <th>Description</th> </tr> </thead> <tbody> <tr> <td>Off</td> <td>No alarms. All alarms acknowledged.</td> </tr> <tr> <td>Red</td> <td>Alarms present. All alarms acknowledged.</td> </tr> <tr> <td>Blinking green</td> <td>No alarms. Unacknowledged alarms present.</td> </tr> <tr> <td>Blinking red</td> <td>Alarms present. Unacknowledged alarms present.</td> </tr> </tbody> </table>	Status	Description	Off	No alarms. All alarms acknowledged.	Red	Alarms present. All alarms acknowledged.	Blinking green	No alarms. Unacknowledged alarms present.	Blinking red	Alarms present. Unacknowledged alarms present.							
Status	Description																	
Off	No alarms. All alarms acknowledged.																	
Red	Alarms present. All alarms acknowledged.																	
Blinking green	No alarms. Unacknowledged alarms present.																	
Blinking red	Alarms present. Unacknowledged alarms present.																	
5	Login user name.																	
6	GX/GP date and time.																	
7	Batch name. Displayed when the batch function is in use. If the information does not fit in the area, the information will scroll at certain intervals.																	
8	Internal memory information. <table border="1"> <tr> <td></td> <td>42%</td> <td>Capacity remaining</td> </tr> <tr> <td>← Capacity used</td> <td>→ Capacity remaining</td> <td></td> </tr> <tr> <td colspan="3">← Total capacity →</td> </tr> </table>		42%	Capacity remaining	← Capacity used	→ Capacity remaining		← Total capacity →										
	42%	Capacity remaining																
← Capacity used	→ Capacity remaining																	
← Total capacity →																		
9	Recording progress status. <table border="1"> <thead> <tr> <th>Icon</th> <th>Description</th> </tr> </thead> <tbody> <tr> <td>D icon</td> <td>Display data file</td> </tr> <tr> <td>E icon</td> <td>Event data file</td> </tr> <tr> <td>E1 icon</td> <td>Event data file of measurement group 1 (when the measurement mode is set to Dual interval)</td> </tr> </tbody> </table> <table border="1"> <tr> <td></td> <td>00:12:56</td> <td>Time until the file is generated</td> </tr> <tr> <td>← Time already recorded</td> <td>→ Time remaining</td> <td></td> </tr> <tr> <td colspan="3">← Time needed to generate file →</td> </tr> </table>	Icon	Description	D icon	Display data file	E icon	Event data file	E1 icon	Event data file of measurement group 1 (when the measurement mode is set to Dual interval)		00:12:56	Time until the file is generated	← Time already recorded	→ Time remaining		← Time needed to generate file →		
Icon	Description																	
D icon	Display data file																	
E icon	Event data file																	
E1 icon	Event data file of measurement group 1 (when the measurement mode is set to Dual interval)																	
	00:12:56	Time until the file is generated																
← Time already recorded	→ Time remaining																	
← Time needed to generate file →																		
10	Recording progress status. Event data file information when both display data and event data are recorded. When the measurement mode is set to Dual interval, the information is for the event data file of measurement group 2. (E2 icon)																	

3.1 Using the Web Application to Change the GX/GP Settings, Monitor Data, and Control the GX/GP (Web server function)

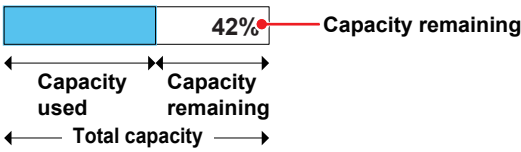
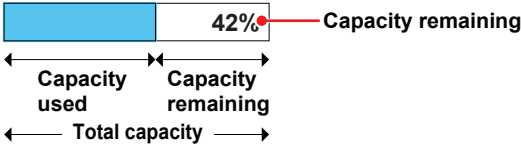
Number	Description
11	<p>SD memory card capacity information.</p>  <p>The diagram shows a horizontal bar representing total capacity. The left portion is filled with blue and labeled 'Capacity used'. The right portion is white and labeled 'Capacity remaining' with '42%' written inside. A red dot is at the end of the white portion. Below the bar, three double-headed arrows indicate the extent of 'Capacity used', 'Capacity remaining', and 'Total capacity'.</p>
12	<p>USB flash memory information. Appears when USB flash memory is connected.</p>  <p>The diagram is identical to the one for item 11, showing a progress bar with 42% capacity remaining and labels for 'Capacity used', 'Capacity remaining', and 'Total capacity'.</p>
13	Mail transmission function. Displayed when the mail transmission function is in use.
14	Error information. Displayed when an error occurs. Click the icon to clear it.
15	Data save information. Appears when the internal memory data is being saved to the external storage medium. Clicking the icon displays a data save cancel dialog box.
16	User lock out occurring. Appears when there is a locked out user.
17	Recording in progress. Appears when recording is in progress. If multi batch (/BT option) is installed, this appears when any batch is recording.
18	Math in progress. Appears when math is in progress.
19	Alarm activated. Appears when any alarm is activated.



**Quick Setting Function (GP10/GP20, Release number 3 (Version 3.02) and later)**

In Quick setting, a minimal setup menu for data collection is displayed. Quick setting allows you to collect data quickly.

Display example of the quick settings tree

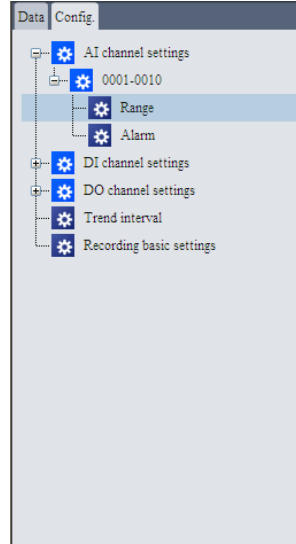

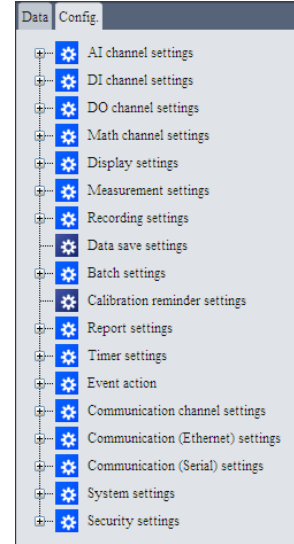

Display example of the standard settings tree



**Switching between Standard Setting Tree and Quick Setting Tree**

On the **SMARTDAC+ Web Service** tab, click **Switch Quick Setting** or **Quit Quick Setting** to switch between the standard setting tree and quick setting tree.

Button	Function
	The display is switched from the standard setting tree to quick setting tree. When switched to the quick setting tree, the button switches to Quit Quick Setting.
	The display is switched from the quick setting tree to standard setting tree. When switched to the standard setting tree, the button switches to Quick Setting.

- If the Web application is closed when the quick setting tree is displayed, the next time a connection is established, the quick setting tree will be displayed.

**Displaying the Quick Setting Tree**

The quick setting tree only displays the range and alarm of I/O channels, recording basic settings, and trend interval.

Display item	Description
IO channel > Range	Configure settings related to the range of each I/O channel.
Input channel > Alarm	Configure settings related to the alarm of each Input channel.
Trend interval	Set the trend interval. This does not appear when the file type is set to Event (default value).
Recording basic settings	Set the event data recording interval and the like.
Dual interval (when the measurement mode is set to Dual interval)	Configure settings related to recording for each scan group.

► For details on the settings, see chapter 1, “Configuring the GX/GP.” In this manual, the operation path (the order in which displays are opened) is described for Standard setting (tree).

### 3.1.3 Controlling the GX/GP

You can carry out the following operations on the Web application. Note that you cannot carry out these operation on a GX/GP whose advanced security function (/AS) is enabled.

- Start and stop recording
- Start, stop, reset, and acknowledge computing
- AlarmACK
- Individual alarm ACK (see “Digital” on 3-27.)
- Set the date and time
- Start, stop, and test mail transmission
- Trigger the starting of event data recording
- Execute manual sampling
- Save event data
- Save display data
- Reset relative timers
- Reset match time timers
- Change a batch number, lot number, and batch comment
- View the batch text
- Change the time using SNTP
- Perform a test print
- Execute a file transmission test on the FTP server
- Write messages (see “Writing Messages” in page 3-16 in section 3.1.4, “Monitoring the GX/GP Data and Controlling the GX/GP from the Monitor Screen”)
- Change the alarm value (see “Digital” on 3-27)
- Change the DO channel output (see “Digital” on 3-27)
- Change the internal switch value (see “Displaying the Internal Switch Status and Changing the Values” on 3-35)
- Change the login password (see page 3-61 in section 3.1.8, “Changing the Password”)
- Stop all control loops (when a PID control module is in use)

Use the following buttons.

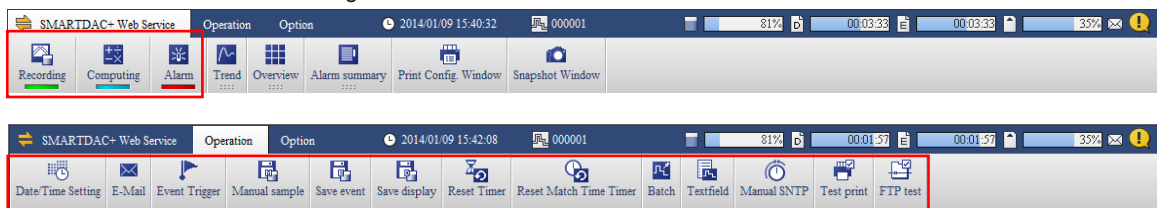

If an operation cannot be carried out from the GX/GP, it will not be possible from the Web application either. For operations that cannot be carried out, the corresponding buttons will not be displayed or will not be selectable.

- If the GX/GP does not have the function or is not using the function.
- User restriction is placed on the operation.
- The GX/GP is not in a condition to accept the operation. For example, if the GX/GP is not recording, you cannot write a message.

3.1 Using the Web Application to Change the GX/GP Settings, Monitor Data, and Control the GX/GP (Web server function)

**Note**

The following alternate screen may appear temporarily during operation. This is not an error.

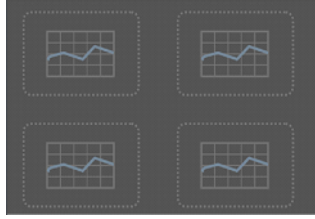

**Starting Recording**

Follow the procedure below to start recording.

**Procedure**

- 1 On the **SMARTDAC+ Web Service** tab, click **Recording**. The Recording dialog box appears.
- 2 If the batch function is in use, enter numbers in the **Batch No.**, **Lot No.**, **Textfield** and **Batch Comment** boxes.

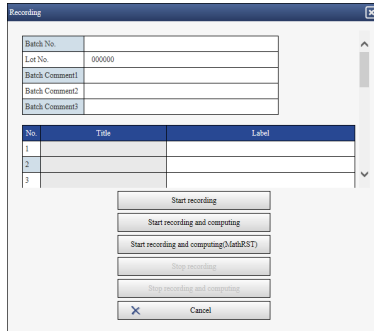

- 3 Click **Start recording** or **Start recording and computing**. Recording starts. The indicator below the **Recording** button turns on.

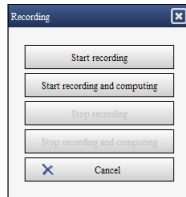

## Stopping Recording

Follow the procedure below to stop recording.

### Procedure

- 1 On the **SMARTDAC+ Web Service** tab, click **Recording**.  
The Recording dialog box appears.
- 2 Click **Stop recording** or **Stop recording and computing**.  
Recording stops. The indicator below the **Recording** button turns off.

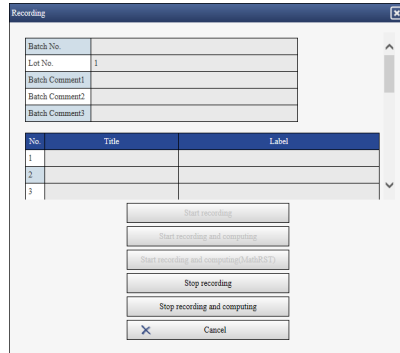

## Starting, Stopping, Resetting, and Acknowledging Computing

### Procedure

- 1 On the **SMARTDAC+ Web Service** tab, click **Computing**.  
The Computing dialog box appears.
- 2 Click a button.  
Start computing: Starts computing on math channels The indicator below the Computing button turns on in blue.  
Stop computing: Stops computing on math channels The indicator below the Computing button turns off.  
Reset computing: Resets computing on math channels  
Math ACK: Clears the icon that appears (on the GX/GP) when a computation data dropout occurs.

## Alarm ACK

Follow the procedure below to acknowledge all alarms that are occurring.

### Procedure

- 1 On the **SMARTDAC+ Web Service** tab, click **Alarm**.  
The Alarm dialog box appears.
- 2 Click **Alarm ACK**.  
Alarms are acknowledged. If the alarm sound is on, it is stopped.

### Indicator below the Alarm button

See "Status Indications."

### Setting the Date and Time

Follow the procedure below to set the GX/GP's date and time.

#### Procedure

- 1 On the **Operation** tab, click **Date/Time Settings**.  
The Date/Time settings dialog box appears.
- 2 Enter the date and time, and click **Update**.  
The GX/GP's date and time are changed.

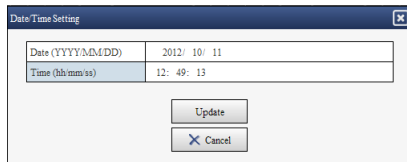

You may not be able to change the time depending on the GX/GP settings or condition. Follow the instructions in the message to handle it.

### Starting, Stopping, and Testing Mail Transmission

#### Procedure

- 1 On the **Operation** tab, click **E-Mail function**.  
The Mail function dialog box appears.
- 2 Click a button.  
Start E-mail transmission: Enables the mail transmission function.  
Stop E-mail transmission: Disables the mail transmission function.  
E-Mail test for recipient 1 or E-Mail test for recipient 2: Sends a test mail to the recipient.

### Triggering the Starting of Event Data Recording

Follow the procedure below to apply a start trigger for event data recording.

#### Procedure

- 1 On the **Operation** tab, click **Event trigger**.  
The Event trigger dialog box appears.
- 2 Click **Execute event trigger**.  
Event data recording that is in the trigger-wait state starts.  
When the measurement mode is set to Dual interval, click **Execute Event trigger meas group 1**, **Execute Event trigger meas group 2**, or **Execute All**.

### Executing Manual Sampling

Follow the procedure below to execute manual sampling.

#### Procedure

- 1 On the **Operation** tab, click **Manual sample**.  
A Manual sample dialog box appears.
- 2 On the **Operation** tab, click **Execute a manual sample**.  
Manual sampling is executed.

### Saving Event Data

Unsaved event data stored in the internal memory is saved to the SD memory card.

#### Procedure

- 1 On the **Operation** tab, click **Event save**.  
An Event save dialog box appears.
- 2 Click **Save event data**.  
The event data is saved.

### Aborting Data Saving

A data save information icon appears in the status display section while data is being saved. Clicking the this icon displays a Data save dialog box. Clicking **Quit save data** aborts data saving.

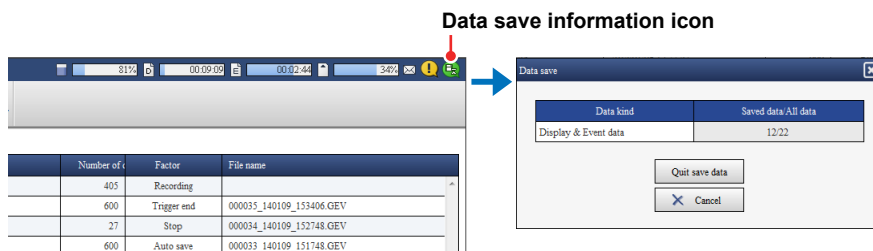

### Saving Display Data

Follow the procedure below to save unsaved display data stored in the internal memory to the SD memory card.

#### Procedure

- 1 On the **Operation** tab, click **Display save**.  
A Display save dialog box appears.
- 2 Click **Save display data**.  
The display data is saved.

### Resetting a Relative Timer

Follow the procedure below to reset and start a relative timer.

#### Procedure

- 1 On the **Operation** tab, click **Timer reset**.  
The Timer reset dialog box appears.
- 2 Click the timer you want to reset, and click **Reset**.  
The timer is reset.

### Resetting a Match Time Timer

Follow the procedure below to reset a timer that has expired.

#### Procedure

- 1 On the **Operation** tab, click **Reset Match Time Timer**.  
The Match time timer reset dialog box appears.
- 2 Click the match time timer you want to reset, and click **Reset**.  
The match time timer is reset.

### Changing the batch number, lot number, and batch comment

Follow the procedure below to change the batch number, lot number, and batch comment. When the GX/GP is recording, you can enter only batch comments that have not been entered yet.

#### Procedure

- 1 On the **Operation** tab, click **Batch**.  
The Batch box appears.
- 2 Enter the batch number, lot number, and batch comment, and click **Change**.  
The batch number, lot number, and batch comment are changed.  
For the procedure to enter the batch number, lot number, and batch comment, see page 1-148 in section 1.15, "Configuring the Batch Function"  
To delete a batch comment, enter a space.

### Viewing the Batch text

Follow the procedure below to view the batch text set on the GX/GP. You cannot change it.

#### Procedure

- 1 On the **Operation** tab, click **Batch**.  
The Batch dialog box appears.
- 2 View the batch text, and click **OK**.

### Changing the Time Using SNTP

Follow the procedure below to query the SNTP server for the time and adjust the GX/GP time.

#### Procedure

- 1 On the **Operation** tab, click **SNTP manual time adjustment**.  
The SNTP manual time adjustment dialog box appears.
- 2 Click **Execute SNTP manual time adjustment**.  
The GX/GP queries the SNTP server for the time.

### Performing a Test Print

Follow the procedure below to perform a test print.

#### Procedure

- 1 On the **Operation** tab, click **Test print**.  
A Test print dialog box appears.
- 2 Click **Execute a test print**.  
A test print is performed.

### Executing a File Transmission Test on the FTP Server

Follow the procedure below to transfer a test file to the FTP server.

#### Procedure

- 1 On the **Operation** tab, click **FTP test**.  
A FTP test dialog box appears.
- 2 Click **Execute an FTP test to the primary** or **Execute an FTP test to the secondary**.  
The GX/GP transfers a test file to the FTP server.

### 3.1.4 Monitoring the GX/GP Data and Controlling the GX/GP from the Monitor Screen

You can retrieve data and display conditions from the GX/GP and view the information using the monitors listed below. You can also perform alarm acknowledge and other operations.

Monitors Trend, digital, bar graph, horizontal bar graph, overview, alarm summary, message summary, DO channel status, internal switch status, Modbus master status, Modbus client status, WT client status, memory data list, report data list, manual sampled data list, various logs, network information, system information, favorite monitor, and SLMP client status

On the trend monitor, digital monitor, bar graph monitor, and horizontal bar graph monitor, channel data is displayed in groups. Up to 4 groups can be displayed.

The favorite monitor is a monitor that displays up to four monitors (except for network information and system information) on a single screen (this is different from the favorite screen registration function of the GX/GP).

#### Display Update Interval

The channel data display is updated at the scan interval. However, the shortest update interval is 1 second.

#### Order of Display Precedence

If the display of the same type of items overlaps, the information of the smallest number takes precedence. For example, if multiple alarms are occurring, the alarm with the smallest alarm level number takes precedence.

#### Note

If the GX/GP system configuration or settings change while the monitor is displayed, the monitor may not display data correctly. In such a case, reload the page.

### Switching the Monitor Display

#### Procedure

On the **Data** tab, click the monitor you want to display. **Favorite monitors** appears when you register a favorite monitor.

You can also switch the screen by clicking a monitor display switch button.

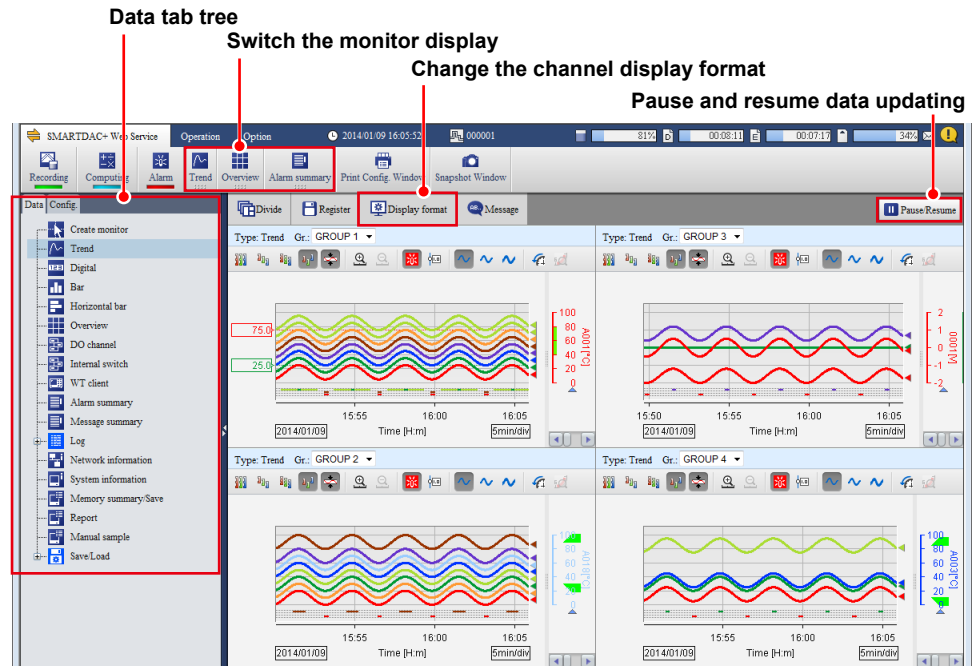



**Note**

You can change the monitor display switch buttons that are displayed on the menu bar. For the procedure, see page 3-60 in section 3.1.7, "Changing the Display Settings on the Browser"

**Pausing and Resuming Data Updating**

Follow the procedure below to pause and resume monitor data updating.

**Procedure**

Each time you click **Pause/Resume**, the monitor data updating pauses or resumes. When data updating is paused, a section of the **Pause/Resume** button icon blinks.

**Note**

If the GX/GP settings are changed when updating is paused, the paused state may be cleared.

**Changing the Channel Display Format**

Follow the procedure below to set the display format of channel names and the digital I/O channel values on the monitors. The settings are applied to all monitors.

**Procedure**

- 1 Click **Display format**.  
A bar appears where you can specify the channel display.
- 2 Select the display format.

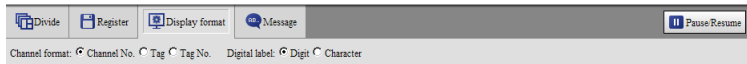

Item	Description
Channel format	Set the display format of channel names to Channel No., Tag, or Tag No.
Digital label	Select the value display format of digital input channels and digital output channels.
Digit	Displays 0s and 1s as they are (using numbers).
Character	Displays 0s and 1s using predefined character strings, such as "OPEN" and "CLOSE." If character strings are not specified, they will be blank.

## Favorite Monitors

Follow the procedure below to create favorite monitors. You can create up to 15 monitors.

### Procedure

#### Registration

- 1 On the **Data** tab, click **Create monitor**.  
A screen for creating a new monitor appears.

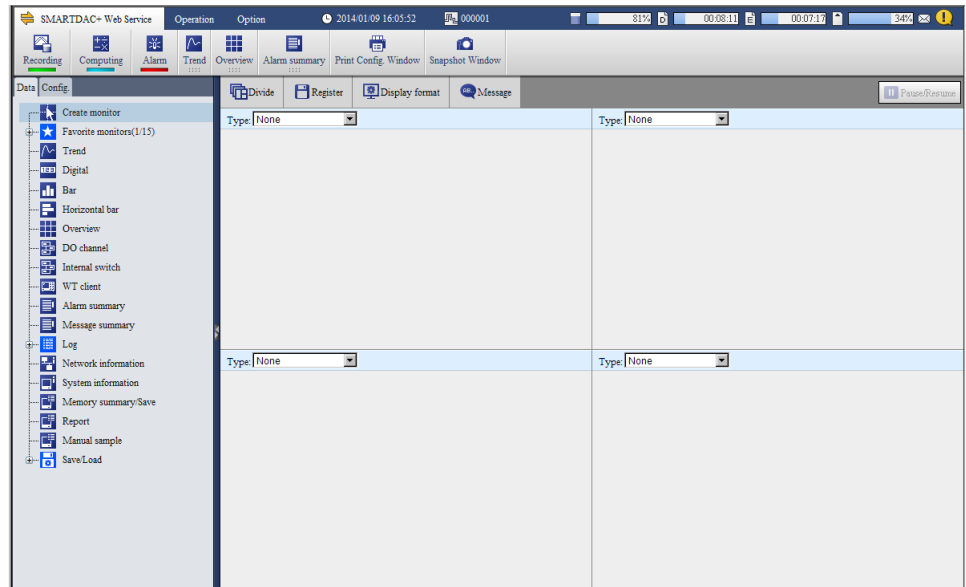

- 2 Click **Divide**.  
Screen multi panel options appear.

- 3 Click the multi panel pattern to use.



- 4 From the **Type** list, select the screen type to display. You can also select **None** (to not register a screen).

- 5 If you select Trend, Digital, or Bar, select the display group from the **Gr.** list.

- 6 Repeat steps 4 and 5 to assign screens to all areas.

- 7 Click **Register**.  
The Name box appears.

- 8 Enter the monitor name, and click **Register**.  
The monitor name is added under **Favorite monitors** in the content selection tree.



#### Monitor name

- You can enter up to 16 characters.
- Tabs will be replaced with spaces.
- Hats (^), single quotation marks, and semicolons will be replaced with underscores.
- Preceding and trailing spaces will be deleted.

### Deleting a Favorite Monitor

- 1 In the content selection tree, point to the favorite monitor you want to delete.
- 2 Click the X mark that appears to the right of the monitor name. A confirmation dialog box appears.

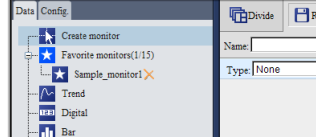

- 3 Click OK. The monitor name is deleted from the content selection tree.

**Note**

You cannot edit a favorite monitor that you created before. If you want to change a favorite monitor, create a new monitor, and overwrite the old one by specifying the same name.

### Trend Monitor, Digital Monitor, Bar Graph Monitor, and Horizontal Bar Graph Monitor

#### Trend Monitor

Trend displays are shown by group.

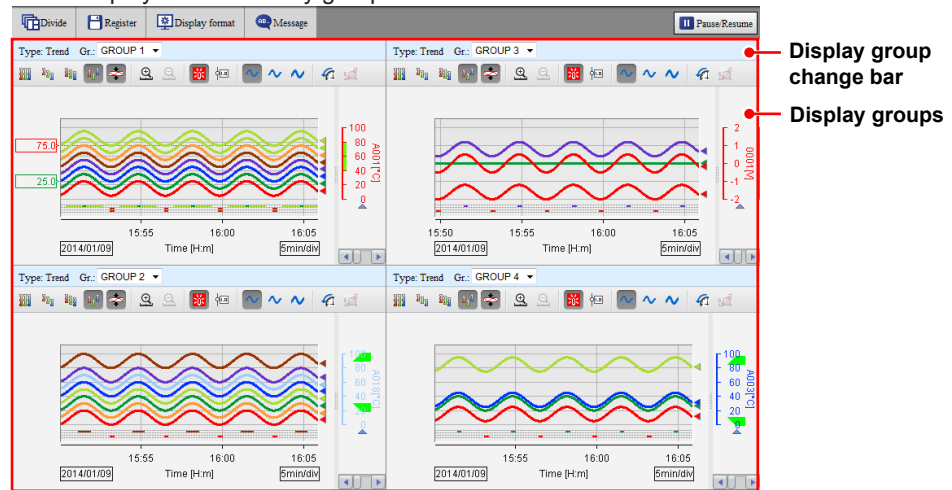

#### Digital Monitor

Digital displays are shown by group.

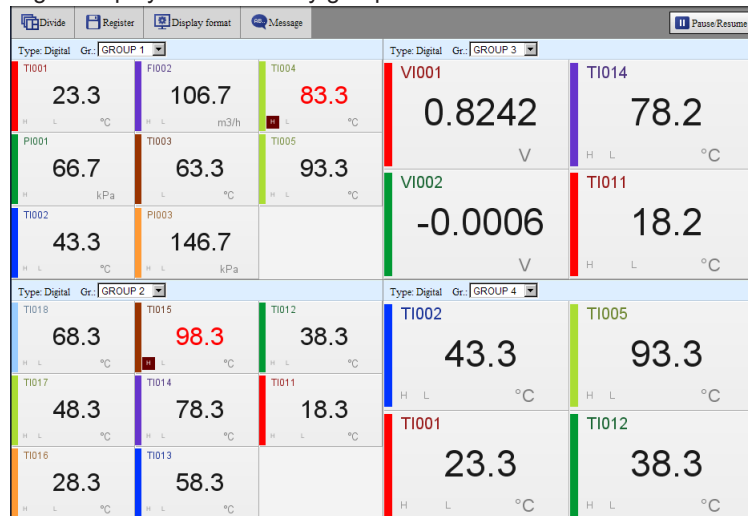

**Bar Graph Monitor and Horizontal Bar Graph Monitor**

Bar graph displays or horizontal bar graph displays are shown by group.

**Bar Graph Monitor**



**Horizontal Bar Graph Monitor**

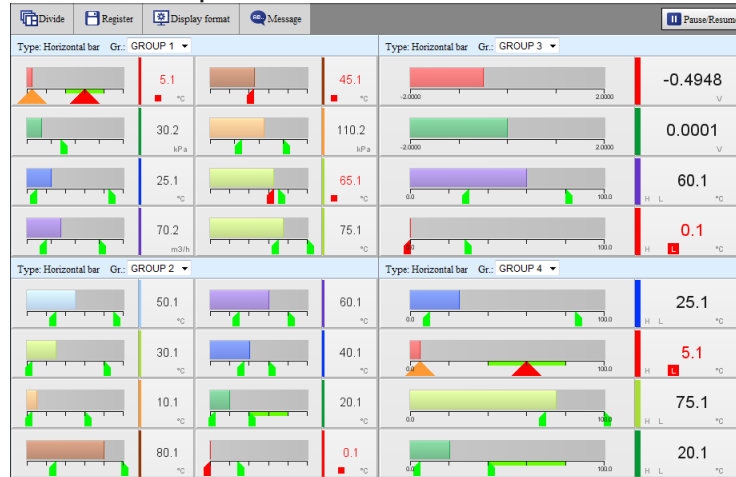

**Note**

- When you start the Web application for the first time, display groups are displayed in accordance with the default conditions. Change the display groups if necessary.
- Changes that you make to the monitor are always retained.

**Changing the Division Setting of the Screen (Trend, digital, bar graph and horizontal bar graph monitors)**

Follow the procedure below to change the division setting of the screen. If you change the division setting, check the group displayed in each area, and change it if necessary (see “Changing Display Groups”). The division setting applies to all four monitors.

**Procedure**

- 1 Click **Divide**.  
A bar appears where you can select the division setting.
- 2 Click the appropriate setting.  
The screen is divided accordingly.

### Changing Display Groups (Trend, digital, bar graph and horizontal bar graph monitors)

Follow the procedure below to change the group to show in each area. This setting applies to all four monitors.

#### Procedure

On the display group change bar, select the display group from the **Gr.** list.

#### Note

You can change an existing monitor and register it as a favorite monitor. For the registration procedure, see "Favorite Monitor" on page 3-18 .

### Writing Messages

Follow the procedure below to write a message at the current time position in the data being recorded. You can execute this procedure when a trend, digital, bar graph, horizontal bar graph, overview, alarm summary, message summary, log, DO channel status, Modbus master, Modbus client, WT client, SLMP client, reminder, batch overview, or internal switch status is displayed.

When you write a message, the screen temporarily shows an alternate screen (see note on page 3-11 ). The message is displayed on the trend. You can also view it in the message summary.

#### Procedure

- 1 Click **Message**.  
A bar appears where you can set the message to write.
- 2 Select **Preset** or **Free** to specify the message.  
Preset messages are fixed messages set in the GX/GP. Select a message from the list.  
Free messages are messages that you enter on the spot. Select a message number from the list, and enter the message string in the text box.

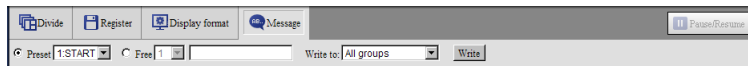

#### Free messages

- Up to 32 characters
- Single quotation marks and semicolons will be replaced with spaces.

- 3 From the **Write to** list, select the display group to write to. Select **All groups** to write the message to all groups.
- 4 Click **Write**.  
The message is written. See the screen example on the next page.

#### Note

If you write a free message, the message string set in the GX/GP will also be replaced.

## Trend

The description of a trend screen that can be displayed in one of the divided areas is given below.

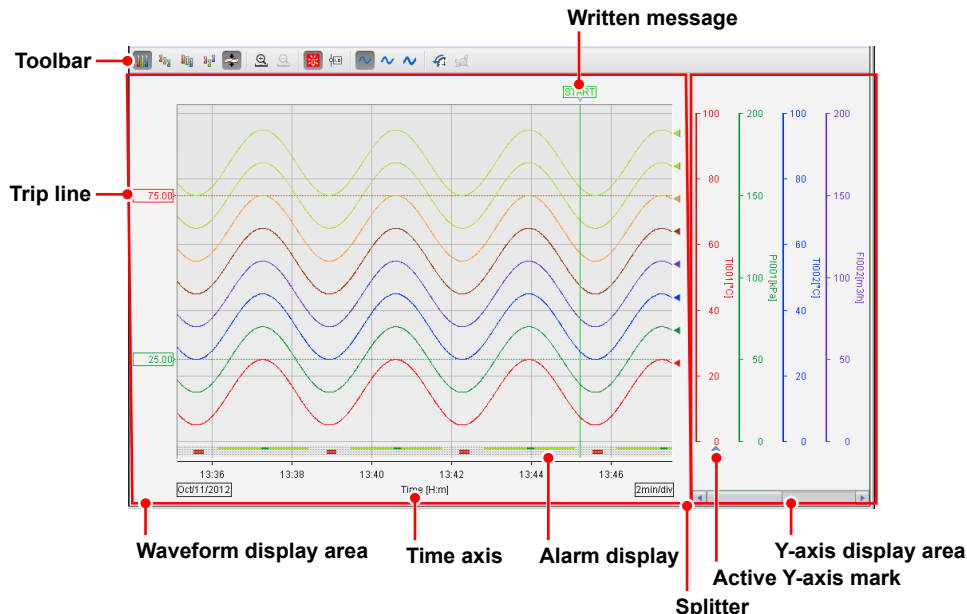

Name	Description
Toolbar	Change the trend waveform display mode.
Waveform display area	Display channel data as waveforms.
Y-axis display area	Displays the Y-axis of each channel. Each Y-axis displays a scale image, channel name, and unit. Alarm point marks and color scale bands are also displayed.
Splitter	Drag the splitter to adjust the sizes of the waveform display area and Y-axis display area.

### Note

- The time axis displays the time of day. It does not display the elapsed time from the start of recording.
- Partial expanded display is not possible.
- If a change is made on the GX/GP that disrupts the continuity of the data, the trend will be cleared.

## Changing the Trend's Active Y-Axis

This procedure applies to the trend display.

### What Is the Active Y-axis?

The active Y-axis refers to the Y-axis that has focus among the multiple waveforms. The waveform display area shows horizontal grid lines that correspond to the active Y-axis.<sup>1</sup> The corresponding waveform is also shown in front.

- <sup>1</sup> If auto zone or free zone is in use (see the next page), the horizontal grid lines of the Y-axes that are in the same column as the active Y-axis are also shown.

### Procedure

In the Y-axis area, click a Y-axis to activate it. The active waveform icon appears below the new active Y-axis.

### Changing the Trend's Waveform Display

This procedure applies to the trend display. You can click the icons in the figure below to change the waveform display.

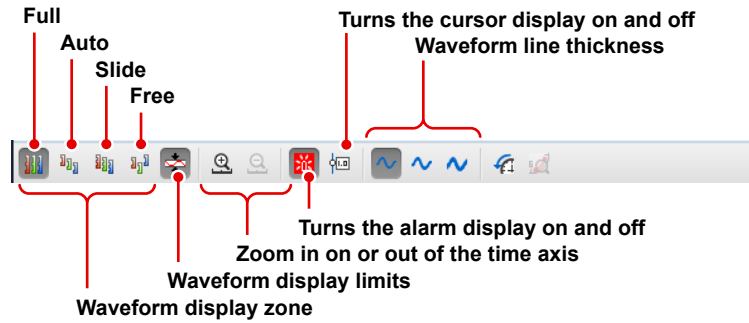

#### Waveform Display Zone

Change the waveform display zone.

Name	Description
Full	Displays all waveforms in full zones.
Auto	Divides the waveform display area into equally spaced zones in accordance with the number of displayed waveforms and displays the waveforms.
Slide	Displays each waveform cascaded from the top to the bottom of the waveform display area.
Free	Displays waveforms in zones specified on the GX/GP.

The following figure shows the Y-axes of each display zone.

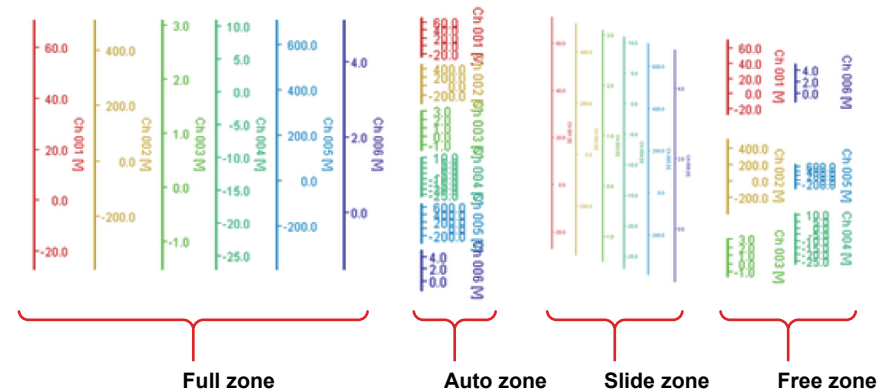

#### Waveform Display Limits

If you apply the waveform display limit, the Y-axis display range is limited to the minimum and maximum values of the scale. Values that are less than the minimum scale value are set to the minimum value, and values that are greater than the maximum scale value are set to the maximum value.

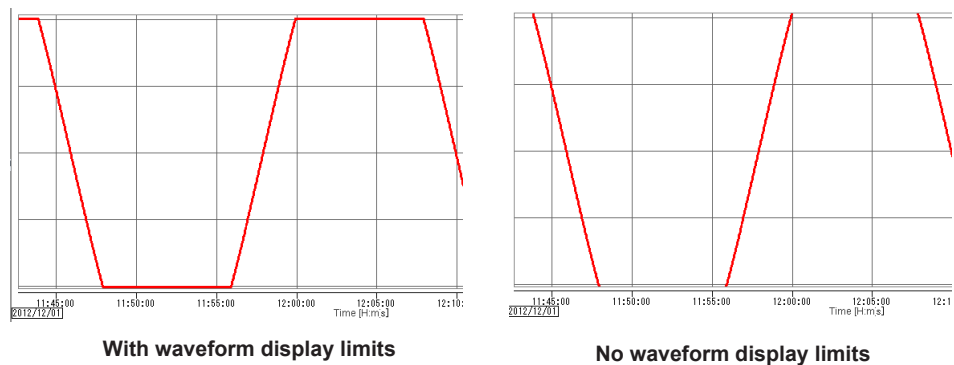

#### Zooming In on or Out of the Time Axis

You can zoom in on or out of the time axis.

### Alarm Display

Alarm information is displayed in the bottom area. Alarm levels (1, 2, 3, and 4) are displayed in order from the top. The duration of each alarm is indicated with a bar using the same color as the corresponding channel. Alarms of channels that correspond to the active Y-axis are shown in front.

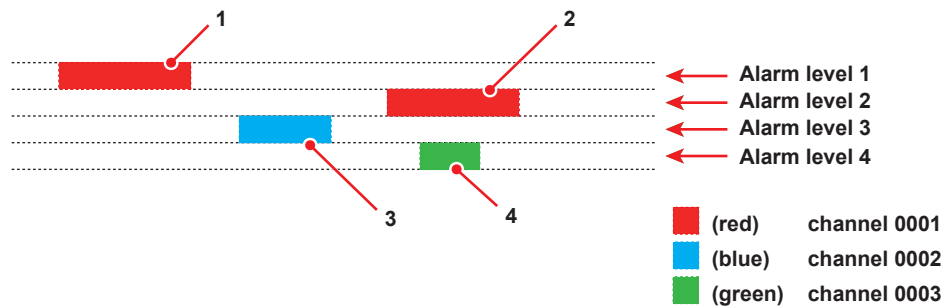

Number	Description
1	An alarm level 1 alarm on channel 0001
2	An alarm level 2 alarm on channel 0001
3	An alarm level 3 alarm on channel 0002
4	An alarm level 4 alarm on channel 0003

### Cursor

You can use cursors to read the values at the cursor. Click the cursor display icon, and click a location on the waveform display area. A cursor appears, and the channel values at the cursor position is displayed in pop-up windows. Drag the pointer to display two cursors. You can read the values at the two positions.

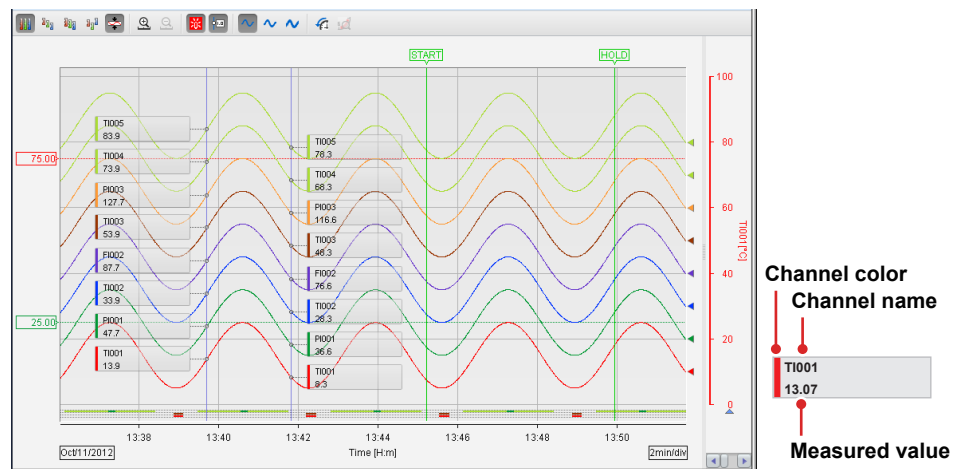

### Note

- The pop-up window for the waveform that corresponds to the active Y-axis is shown in front.
- When waveform display limit is enabled, “+Over,” “-Over,” and “BURNOUT” are displayed for channel values when appropriate.

### Waveform Line Thickness

You can change the waveform line thickness.

### Trip Lines

Trip lines are displayed for the active Y-axis and the Y-axes displayed in the same column as the active Y-axis.



### Displaying Trends' Past Data

You can display past data as a trend. This is called historical trend.

#### Data and Interval That Can Be Displayed as a Historical Trend

The current recording and past recording data can be displayed as historical trends over the following interval.

Interval: From the point when 1 point of data is recorded since the start of recording until the start of the next recording.

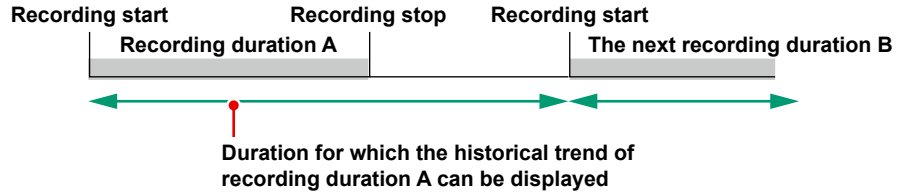

### Displaying the Historical Trend

Click the historical trend icon to display the historical trend. You can use the scroll bar to adjust the display range.

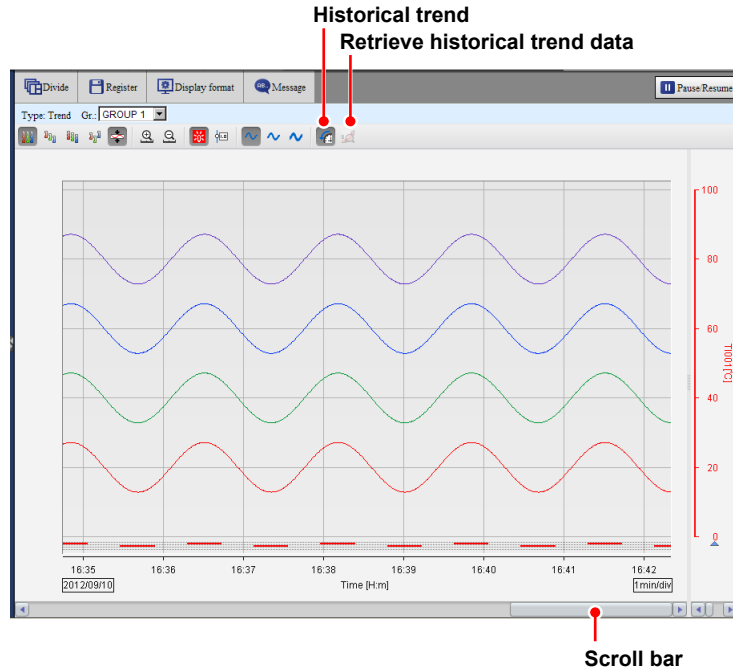

You can carry out the following operations. The procedures are the same as those for the trend display.

- Change the active waveform
- Change the waveform display zone and waveform display limits
- Zoom in on or out of the time axis
- Show or hide alarms information
- Show or hide cursors

The cursor value for display data shows the minimum and maximum values.



- Change the waveform line thickness

### Retrieving Historical Trend Data

Follow the procedure below to retrieve historical trend data from the GX/GP.

#### Note

The Web application has a buffer for historical trend data. The buffer can hold 3600 data points per channel. By retrieving the historical trend data, you can view the data that has been loaded into this buffer from the GX/GP.

- 1 Click the retrieve historical trend data icon.  
A dialog box appears where you can specify the range of historical trend data to retrieve.
- 2 Drag the scroll bar and selection window to specify the interval of historical trend data to retrieve.

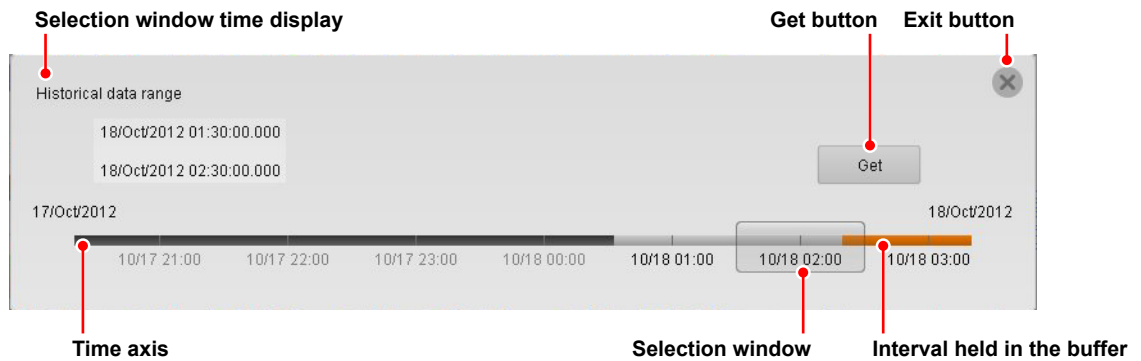

- 3 Click **Retrieve**.  
Data retrieval starts. When the data retrieval is complete, the historical trend data is displayed.

#### Note

If the clock was changed (excluding gradual time adjustment) or a power failure occurred during recording, for data before the last time disruption, the time between what is selected in the dialog box for specifying the interval of historical trend data to retrieve and the actual data will be misaligned. Displaying such data is possible.  
Correct waveforms may not be displayed when settings are changed.



### Bar Graph Monitor and Horizontal Bar Graph Monitor

The description of the bar graph or horizontal bar graph that can be displayed in one of the divided areas is given below.

#### Bar Graph

The bar graph is shown vertically, and the starting point of bars is as according to the GX/GP setting.

#### Horizontal Bar Graph

The bar graph is shown horizontally, and the starting point of bars is as according to the GX/GP setting.

#### Bar Graph

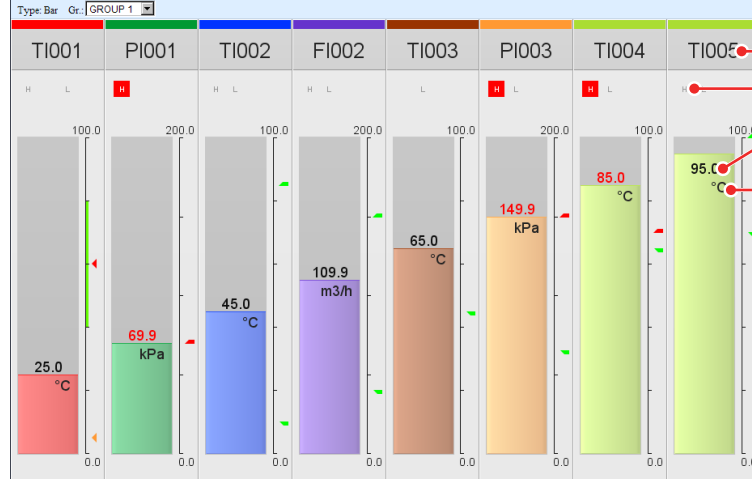

- Tag name
- Alarm mark
- Measured value
- Unit
- Alarm point mark

#### Horizontal Bar Graph



- Tag name
- Measured value
- Unit
- Alarm mark
- Alarm point mark

#### Alarm Marks

See "Digital."

#### When Information Cannot Be Read

Due to space limitations, channel information may not be displayed. If you place the pointer in a channel area and leave it there for about 1 second, the channel name, digital value, and unit will appear in a pop-up window.

#### Executing Individual Alarm Acknowledges, Changing Alarm Values, and Changing DO Output (DO set to Manual)

► See "Digital" on 3-27.

### Overview Monitor

The following four types of overview monitors are available.

- All channel
- Display group
- Display group (detail display)
- Channel in display group

**All channel overview**

**Display group overview**

**Display group overview (detail display)**

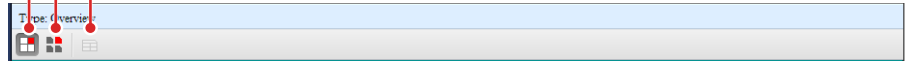

Channel-in-display-group overview can be displayed from the display group overview.

### All Channel

The all channel overview is displayed when the number of active channels is 100 or less. The screen shows channel names, digital values, units, alarm statuses, and types of active alarms.

Type: Overview								
V001	0.9990	Off	F001	H	70.0	T014	H	80.0
					kPa			°C
	Start	Off	T002		45.0	T015	H	100.0
					°C			°C
	Start	Off	F002		110.0	T016		30.0
					m3N			°C
	Start	On	T003		65.0	T017		50.0
					°C			°C
	Start	On	F003	H	150.0	T018		70.0
					xPa			°C
	Start	On	T004	H	85.0			
					°C			
	Start	On	T005		95.0			
					°C			
	Off	On	T011		20.0			
					°C			
	Off	On	T012	H	40.0			
					°C			
	Off	T001	T013	H	60.0			
					°C			

Display Item	Description																					
Channel name	Displays the channel number, tag, or tag number. If the information does not fit, the portion that does not fit is displayed with an ellipsis (...).																					
Digital value	If the value does not fit, it is not displayed.																					
Unit	If the value does not fit, it is not displayed.																					
Type of active alarm	Of the active alarms, the alarm type of the lowest alarm level is displayed.																					
Alarm status	The alarm status at the channel level is displayed with a background color. <b>When the alarm display is set to Nonhold</b> <table border="1"> <thead> <tr> <th>Alarm Status</th> <th>Background Color</th> </tr> </thead> <tbody> <tr> <td>On</td> <td>Red</td> </tr> <tr> <td>Off</td> <td>Green</td> </tr> </tbody> </table> <b>When the alarm display is set to Hold</b> <table border="1"> <thead> <tr> <th>Alarm Status</th> <th>Alarm ACK</th> <th>Background Color</th> </tr> </thead> <tbody> <tr> <td>On</td> <td>Unacknowledged alarms present.</td> <td>Alternating bright and dark red</td> </tr> <tr> <td>On</td> <td>All alarms acknowledged.</td> <td>Bright red</td> </tr> <tr> <td>Off</td> <td>Unacknowledged alarms present.</td> <td>Alternating green and white</td> </tr> <tr> <td>Off</td> <td>All alarms acknowledged.</td> <td>Green</td> </tr> </tbody> </table>	Alarm Status	Background Color	On	Red	Off	Green	Alarm Status	Alarm ACK	Background Color	On	Unacknowledged alarms present.	Alternating bright and dark red	On	All alarms acknowledged.	Bright red	Off	Unacknowledged alarms present.	Alternating green and white	Off	All alarms acknowledged.	Green
Alarm Status	Background Color																					
On	Red																					
Off	Green																					
Alarm Status	Alarm ACK	Background Color																				
On	Unacknowledged alarms present.	Alternating bright and dark red																				
On	All alarms acknowledged.	Bright red																				
Off	Unacknowledged alarms present.	Alternating green and white																				
Off	All alarms acknowledged.	Green																				

3.1 Using the Web Application to Change the GX/GP Settings, Monitor Data, and Control the GX/GP (Web server function)

Due to space limitations, channel information may not be displayed. If you place the pointer in a channel cell and leave it there for about 1 second, the channel name, digital value, unit, and the type of active alarm will appear in a pop-up window.

- **Executing Individual Alarm Acknowledges, Changing Alarm Values, and Changing DO Output (DO set to Manual)**
  - ▶ See “Digital” on 3-27.

**Display Group**

The display group overview shows groups.

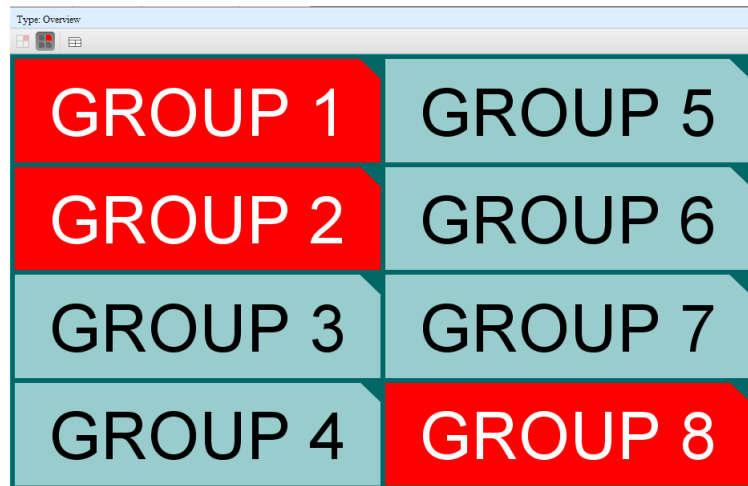

Display Item	Description
Display group name	If the information does not fit, the portion that does not fit is displayed with an ellipsis (...).
Alarm status	The alarm status at the group level is displayed with a background color. For details on the background color, see “Alarm status” in “All Channel.”

Due to space limitations, channel information may not be displayed. If you place the pointer in a group area and leave it there for about 1 second, the group name will appear in a pop-up window.

**Display Group (Detail display)**

When the display group overview is shown, you can click the detail display button to enable and disable detail display mode. Channels in each group are displayed.

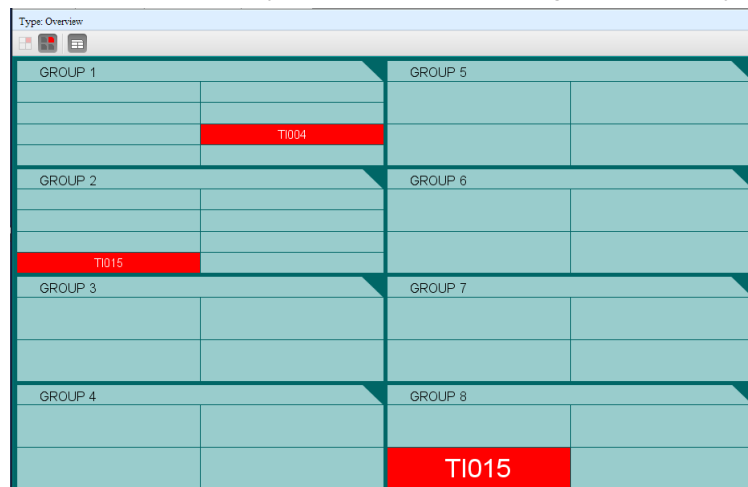

3.1 Using the Web Application to Change the GX/GP Settings, Monitor Data, and Control the GX/GP (Web server function)

Display Item	Description
Display group name	If the information does not fit, the portion that does not fit is displayed with an ellipsis (...).
Channel name	A channel name is displayed in the appropriate cell if the channel has an active alarm or has an unacknowledged alarm when the alarm is set to <b>Hold</b> . If the information does not fit, the portion that does not fit is displayed with an ellipsis (...).
Alarm status	The alarm status at the channel level is displayed with a background color. For details on the background color, see "Alarm status" in "All Channel."

Due to space limitations, channel information may not be displayed. If you place the pointer in a group name area and leave it there for about 1 second, the group name will appear in a pop-up window. If you place the pointer in a channel area and leave it there for about 1 second, the channel name will appear in a pop-up window.

**Channel in Display Group**

When the display group overview is shown, you can click one of the display group areas to display an overview of that group. The displayed information is the same as with "All channel."

**Return to the display group overview.**

**Switch the display group.**

GROUP 1	
TI001 24.8 °C	TI003 64.8 °C
PI001 69.7 kPa	PI003 149.7 kPa
TI002 44.8 °C	TI004 H 84.8 °C
FI002 109.7 m3/h	TI005 94.8 °C

- **Executing Individual Alarm Acknowledges, Changing Alarm Values, and Changing DO Output (DO set to Manual)**
  - ▶ See "Digital" on 3-27.

## Alarm Summary Monitor

The alarm summary monitor displays the GX/GP alarm summary. Up to 1000 items can be displayed. For details on the displayed information, ► see page 2-43 in section 2.3.1, “Listing the Log of Alarm Occurrences and Releases (Alarm Summary)”

Type	Channel No.	Level	Type	Time
ON	A014	1	H : High limit	2014:01:09 16:01:28.000
ON	A013	1	H : High limit	2014:01:09 16:01:28.000
ON	A012	1	H : High limit	2014:01:09 16:01:28.000
ON	A015	1	H : High limit	2014:01:09 16:01:10.500
ACK				2014:01:09 16:00:25.500
ON	A007	1	H : High limit	2014:01:09 16:00:24.500
OFF	A011	3	L : Low limit	2014:01:09 16:00:02.000
OFF	A007	2	L : Low limit	2014:01:09 16:00:02.000
OFF	A005	2	L : Low limit	2014:01:09 16:00:02.000
OFF	A001	3	L : Low limit	2014:01:09 16:00:02.000
ON	A011	3	L : Low limit	2014:01:09 15:59:48.000
ON	A007	2	L : Low limit	2014:01:09 15:59:48.000
ON	A005	2	L : Low limit	2014:01:09 15:59:48.000
ON	A001	3	L : Low limit	2014:01:09 15:59:48.000
OFF	A007	1	H : High limit	2014:01:09 15:59:20.000
OFF	A015	1	H : High limit	2014:01:09 15:58:34.500
OFF	A014	1	H : High limit	2014:01:09 15:58:21.500
OFF	A013	1	H : High limit	2014:01:09 15:58:21.500

### Saving the Alarm Summary

Click **Alarm save**, and follow the instructions in the dialog box that appears. The alarm summary can be saved to an SD memory card or USB flash memory.

### Sorting

Click a column title to sort the alarm summary in ascending or descending order of that column.

### Rearranging Columns

You can rearrange columns by dragging the column title areas. However, the left most column is fixed.

### Changing Column Widths

You can change the column widths by dragging the column boundaries.

### Copying to the Clipboard

Drag the cursor to select the list. Press Ctrl+C on the keyboard to copy the selected list to the clipboard.



### Message Summary Monitor

The message summary monitor displays the GX/GP message summary. Up to 450 items can be displayed. For details on the displayed information, ► see page 2-45 in section 2.3.2, “Displaying the Log of Written Messages (Message summary)”

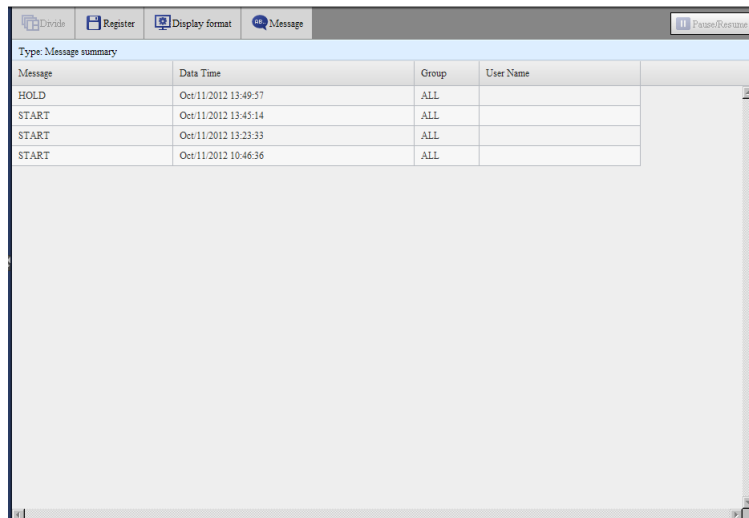

You can sort, rearrange columns, change column widths, and copy to clipboard.

### Error Log Monitor

The error log monitor displays the GX/GP error log. Up to 50 items can be displayed. For details on the displayed information, ► see page 2-53 in section 2.3.5, “Displaying Logs”

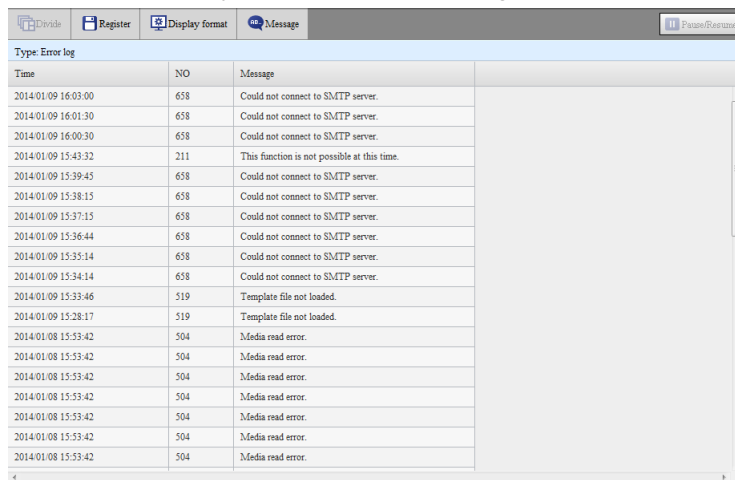

You can sort, rearrange columns, change column widths, and copy to clipboard. The maximum number of log entries is shown below.

Type	Maximum Number of Displayed Events	
Event log	50	Without the advanced security function (/AS)
	3000	With the advanced security function (/AS)
Error log	50	
FTP log	50	
Web log	200	
Mail log	50	
SNTP log	200	
Modbus log	200	
DHCP log	200	
General log	200	
SLMP Log	50	SLMP Communication (/E4)

### Notification Screen Display (/AH option)

When a daily reminder date arrives, a notification screen appears at 00:00 (HH:MM).

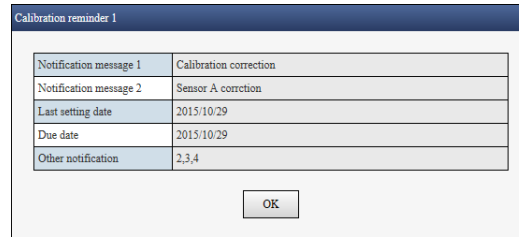

- For details on the notification screen, see page 1-275 in section 1.32.2, “Notification Screen Display”.

### Displaying Reminders (/AH option)

All reminders that are currently valid are displayed.

On the **Data** tab, click **Reminder**.  
The reminder screen appears.

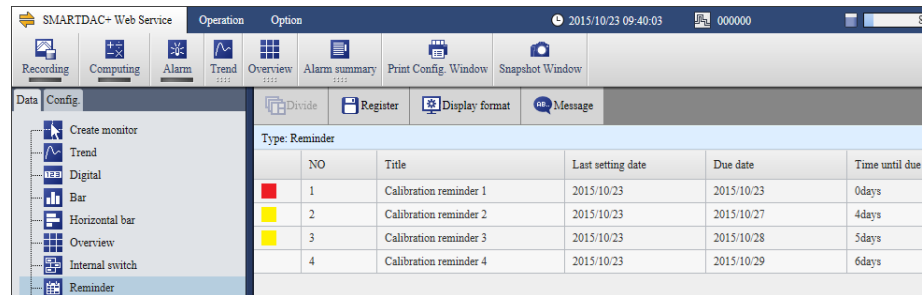

- For details on reminders, see page 1-279 in section 1.32.4, “Displaying Reminders”.

### Changing the Status Display and Output of DO Channels

You can display the DO channel status of the entire system. You can change the DO output that are set to Manual.

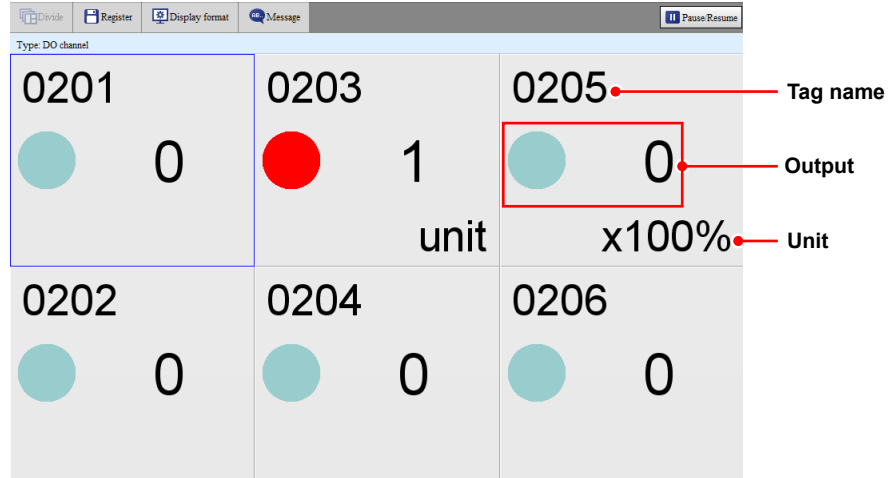

- Up to 60 channels can be displayed. When the display area of each channel becomes small, some of the information will not be displayed.
- The display is updated every second.

#### Changing the DO Output (DO channel set to Manual)

Click a channel area to display a channel information dialog box of that channel. You can control the DO output from the channel information dialog box.

### Displaying the Internal Switch Status and Changing the Values

You can display the internal switch status of the entire system. You can change the values of internal switches that are set to Manual.

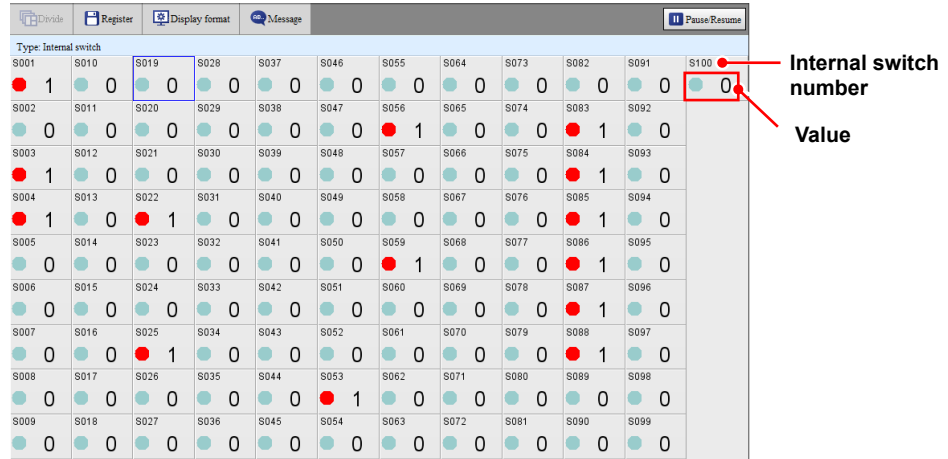

- Up to 100 internal switches can be displayed. When the display area of each channel becomes small, some of the information will not be displayed.
- The display is updated every second.

#### Changing the Internal Switch Values (Internal switches set to Manual)

Click an internal switch area to display a channel information dialog box of that switch. You can change the internal switch value from the channel information dialog box.

### Turning Retransmission Output On and Off (analog output module)

Click a channel area to display a channel information dialog box of that channel. You can control the retransmission output from the channel information box.

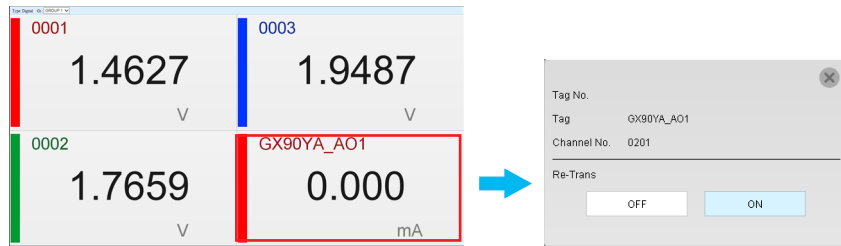

### Collectively Turning the Retransmission Output On and Off

On the **Operation** tab, select **All re-transmission ON/OFF**. Retransmission output can be controlled collectively.

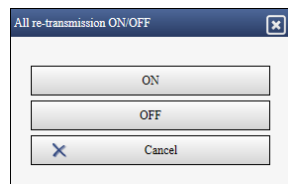

### Manual Operation of Analog Output (analog output module)

Click a channel area to display a channel information dialog box of that channel. You can control the analog output value from the channel information box.



### Modbus Client Status

You can display the command operation status of Modbus clients. For details on the displayed information, see page 2-60 in section 2.3.6, "Checking the Command Status of the Modbus Client and Modbus Master".

For details on how to use the command dropout icon (⚠) and Refresh button, see section 2.3.6.

The display is updated every 5 seconds.

### Modbus Master Status

You can display the command operation status of the Modbus master. For details on the displayed information, see page 2-60 in section 2.3.6, "Checking the Command Status of the Modbus Client and Modbus Master".

For details on how to use the command dropout icon (⚠) and Refresh button, see section 2.3.6.

The display is updated every 5 seconds.

**WT Client Status**

You can display the connection status with the WT power meter. For details on the displayed information, see the WT Communication (/E2) User’s Manual (IM 04L51B01-19EN). The display is updated every 5 seconds.

**SLMP Communication Status**

See the SLMP Communication User’s Manual (IM 04L51B01-21EN).

**Listing and Saving the Measured Data in the Internal Memory**

You can display a list of the measured data (display data and event data) in the internal memory.

- Select the type of data to display using the Data type list box.
- Click a column title to sort the items in ascending or descending order of that column.

Start time	Stop time	Number of	Factor	File name
2014-01-09 16:03:11	2014-01-09 16:13:10	600	Trigger end	000036_140109_160311.GEV
2014-01-09 15:34:06	2014-01-09 15:44:05	600	Trigger end	000035_140109_153406.GEV
2014-01-09 15:27:48	2014-01-09 15:28:14	27	Stop	000034_140109_152748.GEV
2014-01-09 15:17:48	2014-01-09 15:27:47	600	Auto save	000033_140109_151748.GEV
2014-01-09 15:07:48	2014-01-09 15:17:47	600	Auto save	000032_140109_150748.GEV
2014-01-09 14:57:48	2014-01-09 15:07:47	600	Auto save	000031_140109_145748.GEV
2014-01-09 14:47:48	2014-01-09 14:57:47	600	Auto save	000030_140109_144748.GEV

**Saving All Data**

You can save the internal memory’s display data, event data, manual sampled data, and report data.

- 1 Click All save.  
A Memory data save dialog box appears.
- 2 Click a button to specify the save destination.  
The data is saved.

### 3.1 Using the Web Application to Change the GX/GP Settings, Monitor Data, and Control the GX/GP (Web server function)

#### Saving Selected Data

- 1 Select the data you want to save from the list.
- 2 Click **Select save**.  
A Memory data save dialog box appears.
- 3 Click a button to specify the save destination.  
The data is saved.

#### Downloading Data

You can download the selected data to your PC.

- 1 Select the data you want to download.
2. Click **Download**.  
Follow the instructions in the dialog box that appears.

#### Listing and Saving Report Data

You can display a list of the report data in the internal memory.

- Select the type of report data to display from the Report type list box.
- Click a column title to sort the items in ascending or descending order of that column.

Channel No.	Status	Ave	Max	Min	Sum	In
0001 [V]		0.0071	0.4999	-0.5000	2.207990E+01	1
A001 [°C]		15.1	25.0	5.0	4.706981E+04	5
A002 [kPa]		50.3	70.0	30.0	1.563196E+05	3
A003 [°C]		35.1	45.0	25.0	1.092498E+05	2
A004 [m³/h]		90.3	110.0	70.0	2.806798E+05	7
A005 [°C]		55.1	65.0	45.0	1.714298E+05	4
A006 [kPa]		130.3	150.0	110.0	4.050396E+05	1
A007 [°C]		75.1	85.0	65.0	2.336098E+05	6
A008 [°C]		85.1	95.0	75.0	2.646998E+05	7
A011 [°C]		10.1	20.0	0.0	3.152481E+04	0

#### Saving the Report Data

- 1 Click **Save**.  
A Report data save dialog box appears.
- 2 Click a button to specify the save destination.  
All the report data is saved.

### Listing and Saving Manual Sampled Data

You can display a list of the manual sampled data in the internal memory.

- Click a column title to sort the items in ascending or descending order of that column.

Time	0001[V]	A001[°C]	A002[kPa]	A003[°C]	A004[m3/h]	A005[°C]	A006[...]
2014-01-09 16:04:04	0.0487	16.0	51.9	36.0	91.9	56.0	1.1
2014-01-09 16:04:13	0.1927	18.9	57.7	38.9	97.7	58.9	1.1
2014-01-09 16:16:09	-0.3913	7.2	34.3	27.2	74.3	47.2	1.1
2014-01-09 16:16:23	-0.4848	5.3	30.6	25.3	70.6	45.3	1.1
2014-01-09 16:17:49	0.3911	22.8	65.6	42.8	105.6	62.8	1.1
2014-01-09 16:19:33	-0.4232	6.5	33.1	26.5	73.1	46.5	1.1

### Saving Manual Sampled Data

- 1 Click **Save**.  
A Manual sample data save dialog box appears.
- 2 Click a button to specify the save destination.  
All the manual sampled data is saved.

### Network Information Monitor

The network information monitor displays the network information of connected instruments.

Ethernet	
IP Address	192.168.1.100
Subnet Mask	255.255.255.0
Default Gateway	192.168.1.1
MAC Address	00-00-00-00-00-00
DNS Server	
Primary	0.0.0.0
Secondary	0.0.0.0
Domain Suffix	
Primary	
Secondary	
Host name	
Domain name	
Server	
FTP	On
HTTP	On
SNMP	Off
Modbus	Off
General	On

Click **Reload** (in the lower right of the screen) to update the displayed network information.

### System Information Monitor

The system information monitor displays the GX/GP’s basic information, such as the number of channels, and the module configuration.

You can view the measurement mode.

The following figure is for when only the main unit is available. If the expandable I/O is also available, the screen will consist of a System Info tab, Unit Info tab, and Module Info tab.

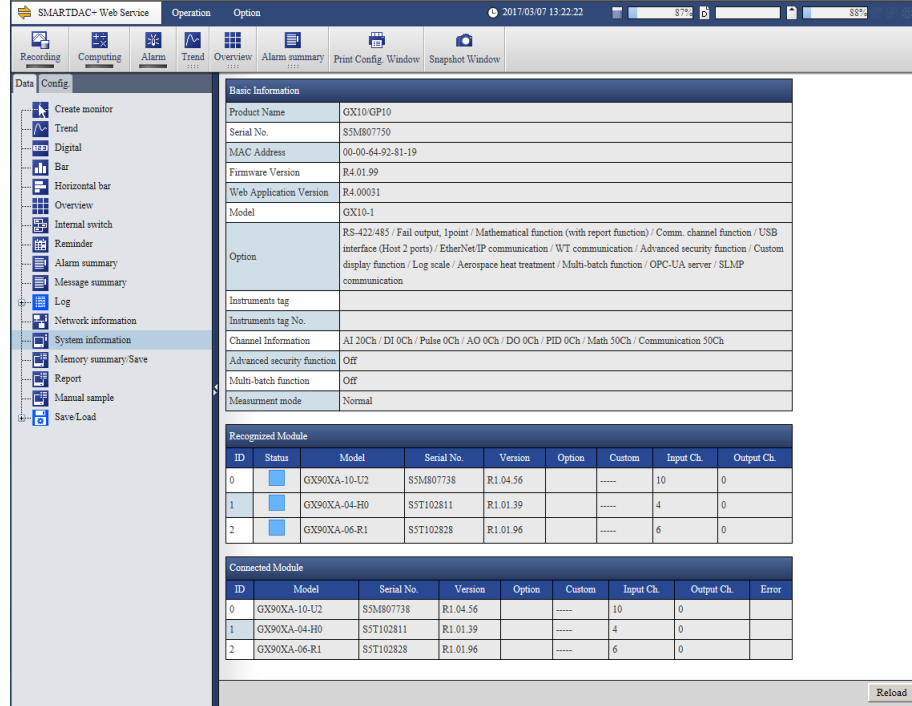

Click **Reload** (in the lower right of the screen) to update the information under **Connected module**.

### Recognized Module and Connected Module

**Recognized module** shows the module configuration that the GX/GP has detected. **Connected module** shows the module configuration that is actually connected to the GX/GP. To align **Recognized module** with **Connected module**, you must perform reconfiguration on the GX/GP.

The **Special Order** column shows special-order information when the product is a TOKUCHU product. The **Status** column shows maintenance information.



### Displaying Snapshot Screens

On the **SMARTDAC+ Web Service** tab, click **Snapshot Window**. The snapshot of the GX/GP appears in a separate window. You can use the tool buttons to perform the operations described below.

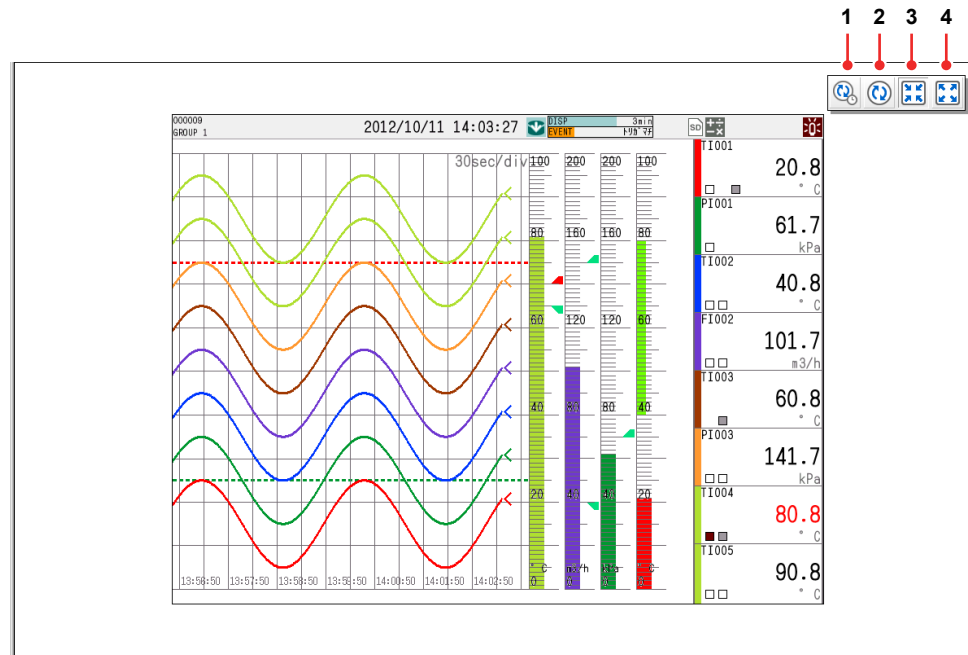

Number	Button Name	Description
1	Auto refresh on/off	Turns on or off the auto refreshing of snapshots. When it is turned on, the screen will be refreshed at approximately 10 second intervals.
2	Refresh	Refreshes the screen. Click the button when about 10 seconds has passed from the previous refresh. If you click the button before about 10 seconds has passed, the screen will show the same screen as the last.
3	Actual size	Displays the snapshot in the actual size, regardless of the snapshot window size.
4	Window size	Displays the snapshot fit to the snapshot window size. However, the aspect ratio of the snapshot is fixed. This may result in blank areas in the top and bottom or in the left or right of the window.

If you close the Web application window, the snapshot window also closes.

**Note**

////// This function is not related to the snapshot function of the GX/GP. ////

### 3.1.5 Changing Settings

Follow the procedure below to change the GX/GP settings. Note that you cannot change the settings of a GX/GP whose advanced security function (/AS) is enabled (the Config tab will not appear). The procedure below is for a GX/GP whose advanced security function (/AS) is not in use.

#### **Note**

The items and selectable values that appear in the setup screen vary depending on the hardware system configuration. If the items that you want to configure do not appear, check the option and module configuration on the system information monitor.

### Notes on Changing Settings

#### **When Settings Can Be Changed**

- You can change settings only when the GX/GP is in a condition that allows setting changes.
- If you are logged in using an account that prohibits setting changes, you will not be able to change the settings.

#### **Limitations on Modifying Settings**

- When not using the login function  
There are no limitations on modifying settings.
- When using the login function  
If you are connected to the GX/GP with an Admin account, there are no limitations on modifying settings.  
If you are connected to the GX/GP with a User account, you cannot specify the security settings (Security settings will not appear in the Config tab).

#### **Limitations on Changing the Login Password**

If you click the Config tab > Security settings > User settings, you will not be able to set the user login password. You can only initialize the password. The default password is "default." To change the user password, log in using the user's account, click Password change on the Option tab, and change it.

#### **Applying Setting Changes**

On each setup screen, send the changed settings to the GX/GP to apply them.

#### **Note**

When settings are changed, the message "Restart is required to reflect this changes. Continue?" may appear. Click **OK**, and the GX/GP will automatically restart.

### Setup Change Procedure

- 1 Click the **Config.** tab.  
The setup item tree appears.
- 2 Click the item you want to change.  
The GX/GP settings are loaded and displayed in the content area.  
Click **Reload** to load and update the displayed settings.

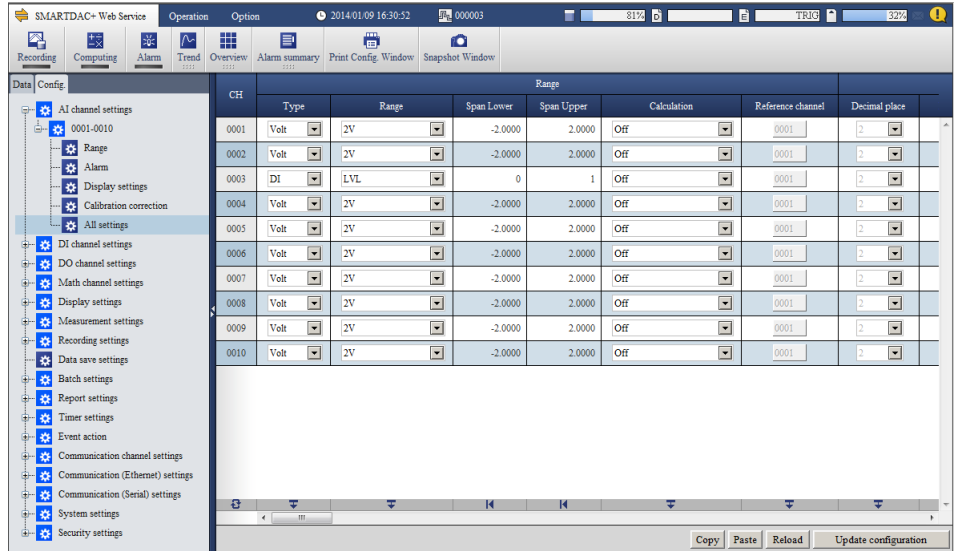

- 3 Edit the settings.  
For the procedure to set each item, see the reference table below.

Setup Item	Refer To
AI channel	Section 1.2
DI channel	Section 1.3
Pulse channel	Section 1.4
AO channel	Section 1.5
DO channel	Section 1.6
Math channel	Section 1.8
Logic math	Section 1.9
Display settings	Section 1.10
Measurement settings	Section 1.11
Recording settings	Section 1.12
Dual interval	Section 1.13
Data save	Section 1.14
Batch settings	Section 1.15
Report settings	Section 1.16
Timer settings	Section 1.18
Event action	Section 1.19
Communication channel settings	Section 1.20
Communication (Ethernet) settings	Section 1.21
Communication (Serial) settings	Section 1.22
System settings	Section 1.23
Security settings	Section 1.24

- 4 Click **Update Config.**  
The GX/GP settings are changed.

**Note**

- If you edit the settings and switch to a different setting screen before applying the settings, the edited settings will be discarded.
- If you edit the settings and click **Reload** before applying the settings, the edited settings will be discarded.

## Editing Settings

This section gives examples of setup editing operations.

### Input Controls and Dialog Boxes

The following table shows the input controls and dialog boxes that are used to edit settings on the Web application.

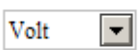
Control Type	Display Example	Operation Example	Setup Procedure
Text Box		Operation example 1	Enter text and numbers.
Check box	<input checked="" type="checkbox"/>	Operation example 2	Click to select the check box. A selected check box indicate "On" or "enabled."
List		Operation example 1	Click the arrow and select from the list that appears.
Option button	<input checked="" type="radio"/> Point <input type="radio"/> Comma	—	Click to select.

Dialog Box Type	Operation Example	Setup Procedure
Channel selection	Operation Example 1	When configuring a specific channel, such as an I/O channel, click a channel number button to specify the channel.
Color selection	Operation Example 2	From the color selection palette in the dialog box, click a color. You can also enter RGB values to specify a color freely.
Multiple channel selection	Operation Example 3	When specifying multiple channels, such as when configuring a display group, click channel number buttons to add channels as character strings to the channel configuration area of the dialog box.
Element selection	Operation Example 4	When specifying an internal switch or other item, click the displayed switch number string. (This is similar to channel selection.)
Calibration correction	Operation Example 5	Edit calibration correction values. Enter the values directly.
Calculation expression input	Operation Example 6	A dialog box for entering calculation expressions. Set calculation expressions by selecting operators and channels from the lists that appear.

In the following pages, representative operation examples in which the dialog boxes above appear will be given.

### Examples of Other Editing Operations

See also the following examples of editing operations.

Operation Example 7	Selecting a Range
Operation Example 8	Copying and Pasting
Operation Example 9	Range selection and copying and pasting in table type screens
Operation Example 10	Editing table type screens using tool buttons
Operation Example 11	Selecting and unselecting check boxes at once
Operation Example 12	Copying and pasting check boxes at once
Operation Example 13	Jumping to a specific item in table type screens

**Operation Example 1**

The DI channel settings screen is shown below.

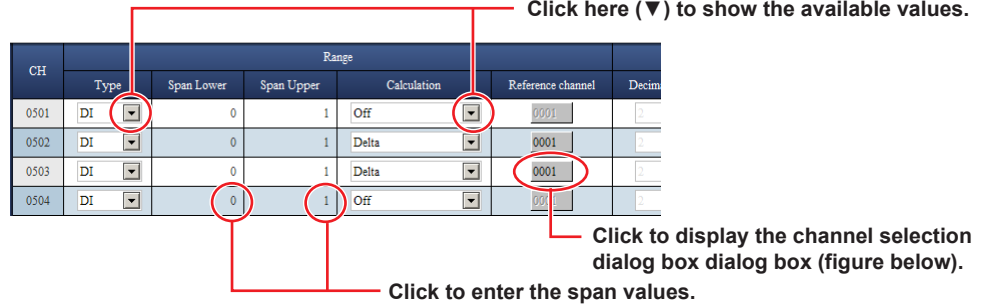

Click here (▼) to show the available values.

Click to enter the span values.

Click to display the channel selection dialog box (figure below).

Channel selection dialog box

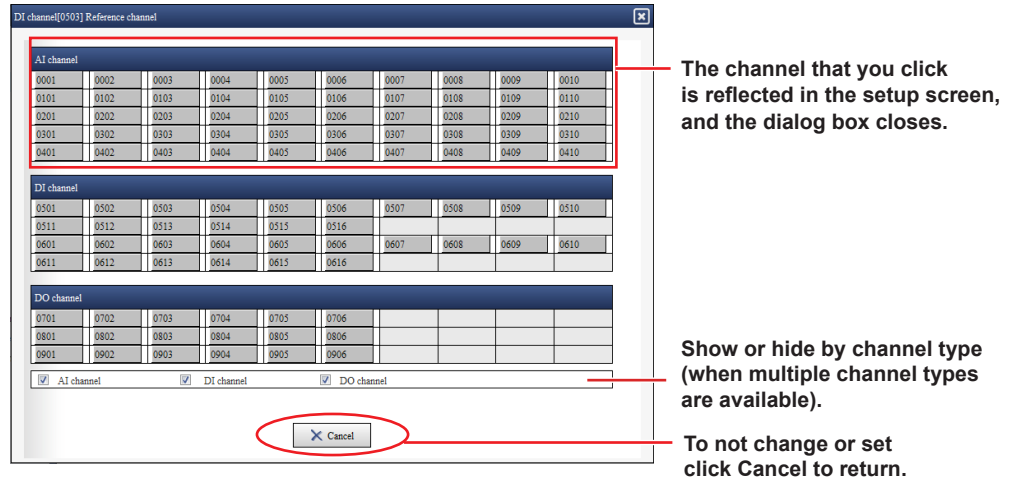

The channel that you click is reflected in the setup screen, and the dialog box closes.

Show or hide by channel type (when multiple channel types are available).

To not change or set click Cancel to return.

**Operation Example 2**

The DI channel settings screen is shown below

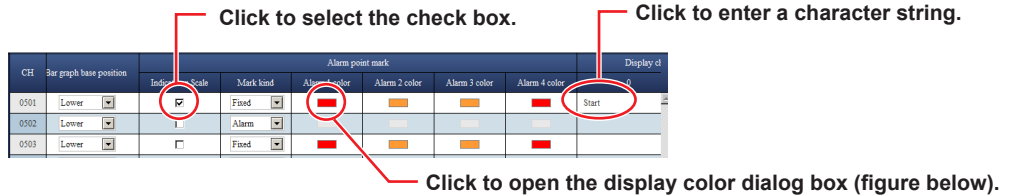

Click to select the check box.

Click to enter a character string.

Click to open the display color dialog box (figure below).

Display color dialog box

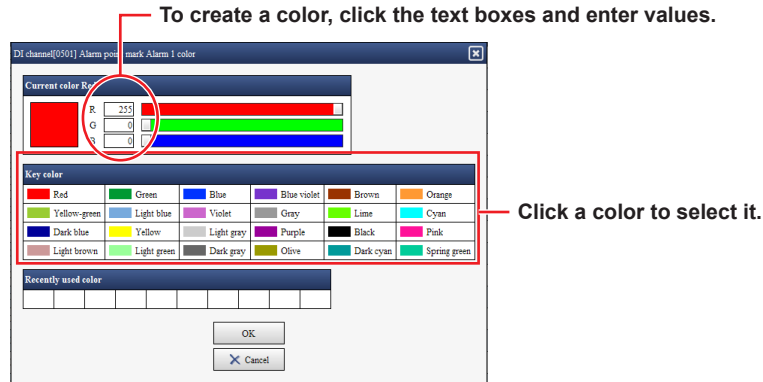

To create a color, click the text boxes and enter values.

Click a color to select it.

3.1 Using the Web Application to Change the GX/GP Settings, Monitor Data, and Control the GX/GP (Web server function)

**Operation Example 3**

This example shows how to assign channels to group 1 on the screen that appears when you click **Display settings** and then **Group settings**.

Group number	On/Off	Group name	Channel set
1	<input checked="" type="checkbox"/>	GROUP 1	A001.A002.A003.A004.A005.A006.A007.A008

Select the check box.

Click to open the group settings dialog box (figure below).

Group settings dialog box

**Group configuration channels**  
You can easily change the display order of channels. Select a channel, and drag the channel to the appropriate position.

Select the channel check boxes to add the channels to the group.

Selected channels

Show or hide by channel.

Click OK to apply the settings to the configuration screen.

**Note**

If the maximum number of selectable channels is reached, you will no longer be able to select additional channels.

**Operation Example 4**

This example shows how to set the alarm output destination on the DI channel settings screen.

CH	On/Off	Type	Value	Hysteresis	Logging	Output type	Output No.
0501	<input checked="" type="checkbox"/>	H: High limit	0.00	0	<input checked="" type="checkbox"/>	Internal switch	
0502	<input type="checkbox"/>	H: High limit	0.00	0	<input type="checkbox"/>	Out	
0503	<input type="checkbox"/>	H: High limit	0.00	0	<input type="checkbox"/>	Out	

Select the check box.

Click to open the Alarm level 1 Output No. dialog box (figure below).

Alarm level 1 Output No. dialog box

The internal switch number that you click is reflected in the setup screen and the dialog box closes.

To not change or set click Cancel to return.

**Operation Example 5**

This example shows how to edit calibration correction on the AI channel settings screen.

Select the calibration correction mode.

Select the number of set points.

CH	an	Mode	Number of set points	Linearizer input/output
0001		Linearizer Approximation	12	Linearizer input/output
0002		Cal		Linearizer input/output

Click to open the calibration correction dialog box (figure below).

Calibration correction dialog box

Calibration correction points

Linearizer input/output number	Linearizer input	Linearizer output
1	-2.0000	-2.0000
2	-1.6364	-1.6364
3	-1.2727	-1.2727
4	-0.9091	-0.9091
5	-0.5455	-0.5455
6	-0.1818	-0.1818
7	0.1818	0.1818
8	0.5455	0.5455
9	0.9091	0.9091
10	1.2727	1.2727
11	1.6364	1.6364
12	2.0000	2.0000

Edit set points.

Click OK to save the edited results.

For details on calibration correction, see page 1-53 in section 1.2.4, "Setting Calibration Correction (Linearizer approximation, linearizer bias, Correction Factor 1 (release number 3 and later))"

**Operation Example 6**

This is an example of entering a calculation expression in a calculation expression input dialog box in the Calculation expression setup screen of Math channel settings.

CH	On/Off	Calculation expression
A001	<input checked="" type="checkbox"/>	0001 Calculation expression
A002	<input checked="" type="checkbox"/>	0001 Calculation expression
A003	<input checked="" type="checkbox"/>	0001 Calculation expression
A004	<input type="checkbox"/>	0001 Calculation expression

Select a On/Off check box and click Calculation expression to open a dialog box for entering an expression.

Math channel [A001] Calculation expression

0001

Basic operator

Basic operator | Relation operator | Logical operator | Statistic operator | Special operator | Cond

SQR( | ABS( | LOG( | EXP( | LN( | ( | )

OK | Cancel

Calculation expression edit box  
Click the position where you want to insert an operator.

Select the operator type from the list box or tabs to display operator buttons.

Click the button for the operator you want to insert in the calculation expression. The operator appears in the calculation expression edit box.

Click OK to close the dialog box. The entered expression appears in Calculation expression in the setup window.

### 3.1 Using the Web Application to Change the GX/GP Settings, Monitor Data, and Control the GX/GP (Web server function)

Moving the cursor over the Calculation expression column on the setup screen shows the entire expression in a pop-up. This is useful when you want to view a long expression that does not fit in the column.

CH	On/Off	Calculation expression	Decimal place
A001	<input checked="" type="checkbox"/>	0101+0102+0103+0104+0105+0106+0107+0108+0109+0110+0111+0112+0113+0114+0115+0116	2
A002	<input checked="" type="checkbox"/>	0001	2
A003	<input checked="" type="checkbox"/>	0001	2

When you click Update Config to send the settings to the GX/GP, if the calculation expression appears in red, the expression is invalid. Refer to the pop-up that appears showing an error message.

### Range Selection and Copying and Pasting

You can select a range of settings and edit them collectively or copy and paste them. This section explains how to select a range of settings and how to use the **Copy**, **Paste**, and **Tool** buttons.

#### Note

When you attempt to copy and paste values, Internet Explorer may show the message "Do you want to allow this webpage to access your clipboard?" Click **Allow access** to enable the copy and paste feature of the Web application. If you click **Don't allow**, you will not be able to use the copy and paste feature.

### Operation Example 7

#### Selecting a Range

The screen that appears when you select **Display settings** and then **Trend settings** will be used as an example to explain the procedure.

- 1 Click a line name.

Trend settings	
Direction	<input checked="" type="radio"/> Vertical <input type="radio"/> Horizontal
Trend clear	<input type="radio"/> Off <input checked="" type="radio"/> On
Trend line	<input type="radio"/> Thick <input checked="" type="radio"/> Normal <input type="radio"/> Thin
Grid	Auto
Scale	
Digit	<input checked="" type="radio"/> Normal <input type="radio"/> Fine
Value indicator	<input checked="" type="radio"/> Mark <input type="radio"/> Bar graph
Digit of mark	3 digits
Partial	
On/Off	<input type="radio"/> Off <input checked="" type="radio"/> On
Message	
Write group	<input checked="" type="radio"/> Common <input type="radio"/> Separate
Power-fail message	<input checked="" type="radio"/> Off <input type="radio"/> On
Change message	<input checked="" type="radio"/> Off <input type="radio"/> On

Click the line name.

The line is selected.



- 2 Drag the cursor and release the mouse at the last line you want to select.

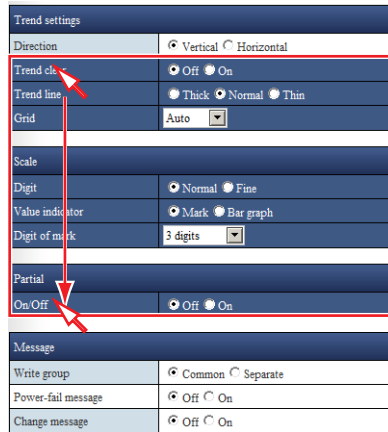

Drag across line titles to select multiple lines.

Multiple lines are selected.

**Note**

When selecting a range, you cannot select multiple nonconsecutive lines one by one. You cannot select an individual column.

**Operation Example 8**

**Copying and Pasting**

You can edit copied information in Excel or text editor and paste it back in the Web application. Below is an example of how to edit information in Excel.

- 1 Select the copy source.
- 2 Click **Copy**, which is in the lower right of the screen. You can also press Ctrl+C on the keyboard.  
When the range is copied to the Clipboard, the color of the range changes as shown below.

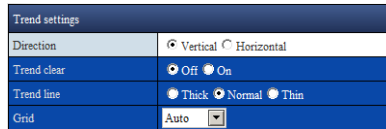

- 3 Paste the contents of the Clipboard to an Excel spreadsheet. The figure below shows an example in which the contents are copied to cell A1 of an Excel spreadsheet. If the pasted contents do not appear correctly, check the format of the cell that you are pasting to.

	A	B	C
1	Trend clear	Off	
2	Trend line	Normal	
3	Grid	Auto	
4			

- 4 Edit the settings in Excel.

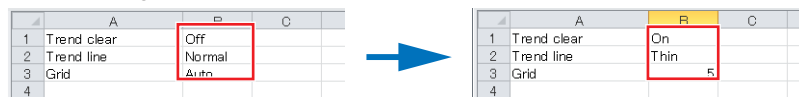

Edit the values in the B column in Excel.

- 5 Copy the edit results from the Excel spreadsheet. Copy not just the values but also the item names in row A.

	A	B	C
1	Trend clear	On	
2	Trend line	Thin	
3	Grid	5	
4			

- 6 Select the paste destination. Make the paste range the same as the range of the copied data (the number of lines).

Trend settings	
Direction	<input checked="" type="radio"/> Vertical <input type="radio"/> Horizontal
Trend clear	<input checked="" type="radio"/> Off <input type="radio"/> On
Trend line	<input type="radio"/> Thick <input checked="" type="radio"/> Normal <input type="radio"/> Thin
Grid	Auto <input type="button" value="v"/>

- 7 Click **Paste**, which is located in the lower right of the window. You can also press Ctrl+V on the keyboard.

Trend settings	
Direction	<input checked="" type="radio"/> Vertical <input type="radio"/> Horizontal
Trend clear	<input type="radio"/> Off <input checked="" type="radio"/> On
Trend line	<input type="radio"/> Thick <input type="radio"/> Normal <input checked="" type="radio"/> Thin
Grid	5 <input type="button" value="v"/>

The edit results from the Excel spreadsheet is pasted to the configuration window.

**Note**

- Depending on the format of the Excel cells that you are pasting to, the values may change when you paste the contents from the Clipboard. For example, if the format is set to **Number**, "0001" will change to "1". You can prevent pasted values from being automatically corrected by setting **Number to Text** in the Format Cells dialog box of the Excel sheet that you want to paste to.
- If the values cannot be pasted as they are to the Excel sheet even with the settings above, we recommend that you use a text editor for copying and pasting.
- If the values that you edit with Excel or text editor are outside the setting range, when you paste the data, the values will be corrected in the same way as when you enter values directly.

**Operation Example 9**

**Range Selection and Copying and Pasting in Table Type Screens**

The AI channel settings screen will be used as an example to explain the procedure. In table type screens, you can also edit copied information in Excel or text editor and paste it back in the Web application (see note on page 3-50).

- 1 Select a range of channels as shown below.

CH	Type	Range	Range		Calculation	Reference channel	Decimal place
			Span Lower	Span Upper			
0001	Skip	EV	-2.0000	2.0000	Off	0001	1
0002	Volt	200mV	-100.00	150.00	Off	0001	1
0003	TC	S	10.0	25.0	Delta	0001	1
0004	RTD	Pt100	-200.0	850.0	Linear scaling	0001	2

Click the name of the line to select the entire line.  
Drag down to select multiple lines.

- 2 Copy the channel information (lines).

CH	Type	Range	Range		Calculation	Reference channel	Decimal place
			Span Lower	Span Upper			
0001	Skip	EV	-2.0000	2.0000	Off	0001	1
0002	Volt	200mV	-100.00	150.00	Off	0001	1
0003	TC	S	10.0	25.0	Delta	0001	1
0004	RTD	Pt100	-200.0	850.0	Linear scaling	0001	2

Press Ctrl+C, or click Copy to copy the lines.

**3** Paste to different channels.

CH	Type	Range	Range		Calculation	Reference channel	Decimal place
			Span Lower	Span Upper			
0001	Skip	2V	-2.0000	2.0000	Off	0001	2
0002	Volt	200mV	-100.00	150.00	Off	0001	2
0003	TC	S	10.0	25.0	Delta	0001	2
0004	RTD	Pt100	-200.0	850.0	Linear scaling	0001	2
0005	Skip	1-5V	0.0000	2.0000	Square root	0001	2
0006	Volt	200mV	-100.00	150.00	Off	0001	2
0007	TC	S	10.0	25.0	Delta	0001	2
0008	RTD	Pt100	-200.0	850.0	Linear scaling	0001	2
0009	Volt	2V	-2.0000	2.0000	Off	0001	2
0010	Volt	2V	-2.0000	2.0000	Off	0001	2

Select the cells to paste to.  
Press Ctrl+V, or click Paste to paste to the lines.

**Note**

In Chrome, you cannot use the Paste button. To paste, press Ctrl + V on the keyboard, or select Paste from the browser's menu.

**Operation Example 10**

**Editing Table Type Screens Using Tool Buttons**

On table type windows, you can use the tool buttons that are shown at the bottom of each table. The available types of tool buttons are "Initialize", "Paste to all lines", "Increment", "Minimum", "Maximum", and "Change all". You can use them to edit items collectively. In the example below, the **Paste to all** tool button is used to set the **Type** of all selected channels in the AI channel setting screen.

- 1 Select the line that contains the data you want to copy.  
CH0001 is selected.

Select the line to copy from.

Data to copy

Paste destination

- 2 Drag the cursor to the last line that you want to assign the same type.  
Channels up to CH0004 are selected.

CH	Type	Range	Range		Calculation
			Span Lower	Span Upper	
0001	Volt	2V	-2.0000	2.0000	Off
0002	GS	1-5V	1.0000	5.0000	Linear scaling
0003	GS	1-5V	1.0000	5.0000	Linear scaling
0004	GS	1-5V	1.0000	5.0000	Linear scaling
0005	Volt	2V	-2.0000	2.0000	Off
0006	Volt	2V	-2.0000	2.0000	Off

Drag until the last line you want to paste the same data to.

3.1 Using the Web Application to Change the GX/GP Settings, Monitor Data, and Control the GX/GP (Web server function)

3 Click the “Past to all” button on the tool bar.

CH	Type	Range	Range		Calculation
			Span Lower	Span Upper	
0001	Volt	2V	-2.0000	2.0000	Off
0002	Volt	2V	1.0000	2.0000	Linear scaling
0003	Volt	2V	1.0000	2.0000	Linear scaling
0004	Volt	2V	1.0000	2.0000	Linear scaling
0005	Volt	2V	-2.0000	2.0000	Off
0006	Volt	2V	-2.0000	2.0000	Off
0007	Volt	2V	-2.0000	2.0000	Off
0008	Volt	2V	-0.2000	0.8500	Off
0009	Volt	2V	-2.0000	2.0000	Off
0010	Volt	2V	-2.0000	2.0000	Off









Click the “Paste to all” tool button.

The type of CH0002 to CH0004 is set to Volt.

**Note**

- When you use the tool button to paste settings to change the settings, the values are automatically corrected in the same way as when you enter values directly.
- Tool buttons are unavailable when no lines are selected (except for the “Change all” button).

The table below shows the different tool button types and their functions.

Button	Icon	Function
Past to all		Pastes the value in the first selected line to all other lines.
Increment		<ul style="list-style-type: none"> <li>• For numeric input Paste numbers to all selected lines by auto-incrementing the least significant digit, starting with the number in the first selected line.</li> <li>• For character string input Paste the character string of the first line appended with auto-incremented sequence numbers to all selected lines. If the character string of the first selected line ends with a number, this number will be used as the first sequence number. If the character string of the first selected line ends with a character, the sequence number 1 is appended to the character string of the first selected line.</li> </ul>
Initialize		Initializes the values of the selected lines to their defaults.
Minimize		Sets the values of the selected lines to their minimum values.
Maximize		Sets the values of the selected lines to their maximum values.
Change all		<ul style="list-style-type: none"> <li>• For check boxes Switches the check box values of the selected lines at once. If all the check boxes of the selected lines are selected, they are cleared. If they are cleared, they are selected.</li> <li>• For line name (left most) columns Selects or unselects all lines in the table.</li> </ul>

**Operation Example 11**

**Selecting and Unselecting Check Boxes at Once**

The example below shows the screen that appears when you select **Display settings - Group settings - Channel set**.

**Selecting a Range of Check Boxes**

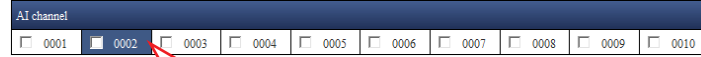

Click a label in a cell to select a single cell.

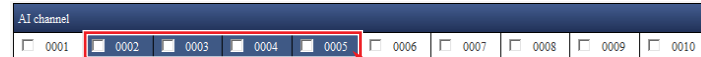

Drag to select cells in a rectangular area.

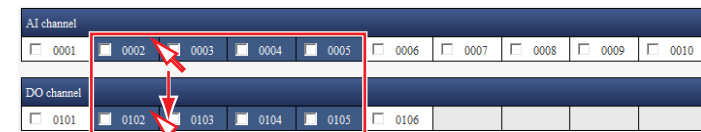

Selection can be made across different blocks.

**Selecting or Unselecting at Once**

Follow the procedure below to select or unselect check boxes at once.

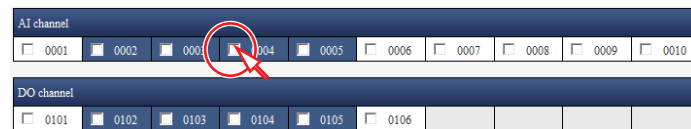

Click **On/Off**, or hold down **Ctrl** and click a check box to select or unselect all the check boxes in the selected area at once.

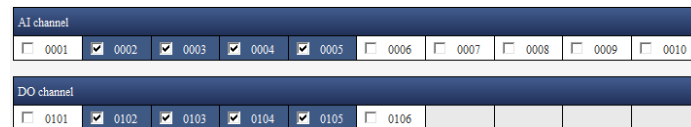

All the check boxes in the selected range are selected.

Each time you click **On/Off**, the check boxes in the selected range become selected or unselected at once.

Hold down **Ctrl** and click a check box that is selected to unselect all check boxes in the selected range. Hold down **Ctrl** and click a check box that is not selected to select all check boxes in the selected range.

**Operation Example 12**

**Copying and Pasting Check Boxes at Once**

Follow the procedure below to paste the copy source. In check box type screens, you can also edit copied information in Excel or text editor and paste it back in the Web application. In Excel, a selected check box is indicated as On; an unselected check box is indicated as Off.

AI channel										
<input type="checkbox"/> 0001	<input checked="" type="checkbox"/> 0002	<input checked="" type="checkbox"/> 0003	<input checked="" type="checkbox"/> 0004	<input checked="" type="checkbox"/> 0005	<input type="checkbox"/> 0006	<input type="checkbox"/> 0007	<input type="checkbox"/> 0008	<input type="checkbox"/> 0009	<input type="checkbox"/> 0010	
DO channel										
<input type="checkbox"/> 0101	<input type="checkbox"/> 0102	<input type="checkbox"/> 0103	<input type="checkbox"/> 0104	<input type="checkbox"/> 0105	<input type="checkbox"/> 0106					

Select the cells to copy from, and press **Ctrl+C** to copy.

AI channel										
<input type="checkbox"/> 0001	<input checked="" type="checkbox"/> 0002	<input checked="" type="checkbox"/> 0003	<input checked="" type="checkbox"/> 0004	<input checked="" type="checkbox"/> 0005	<input type="checkbox"/> 0006	<input type="checkbox"/> 0007	<input type="checkbox"/> 0008	<input type="checkbox"/> 0009	<input type="checkbox"/> 0010	
DO channel										
<input type="checkbox"/> 0101	<input checked="" type="checkbox"/> 0102	<input checked="" type="checkbox"/> 0103	<input checked="" type="checkbox"/> 0104	<input checked="" type="checkbox"/> 0105	<input type="checkbox"/> 0106					

Select the cell to paste to and drag to select a range.

AI channel										
<input type="checkbox"/> 0001	<input checked="" type="checkbox"/> 0002	<input checked="" type="checkbox"/> 0003	<input checked="" type="checkbox"/> 0004	<input checked="" type="checkbox"/> 0005	<input type="checkbox"/> 0006	<input type="checkbox"/> 0007	<input type="checkbox"/> 0008	<input type="checkbox"/> 0009	<input type="checkbox"/> 0010	
DO channel										
<input type="checkbox"/> 0101	<input checked="" type="checkbox"/> 0102	<input checked="" type="checkbox"/> 0103	<input checked="" type="checkbox"/> 0104	<input checked="" type="checkbox"/> 0105	<input type="checkbox"/> 0106					

Press **Ctrl+V** to paste.

**Note**

If the cells whose check box is selected (on) reaches the maximum selectable number, cells whose check boxes are unselected become unavailable, and you will not be able to paste to them. You cannot paste to cells that do not have check boxes.

**Operation Example 13**

**Jumping to a Specific Item in Table Type Screens**

In a table type setup screen (e.g., AI channel settings), not all the setup items fit on the screen. In such a case, you can jump to a specific item you want to set.

- 1 Click the icon in the upper right of the screen. A list box for selecting the jump destination appears.
- 2 Enter the target channel, and click the item that you want to set. The specified setup item is displayed.

CH	Type	Range	Span Lower	Span Upper	Calculation	Refer
0001	Volt	2V	-2.0000	2.0000	Off	
0002	Volt	2V	-2.0000	2.0000	Off	
0003	Volt	2V	-2.0000	2.0000	Off	
0004	Volt	2V	-2.0000	2.0000	Off	
0005	Volt	2V	-2.0000	2.0000	Off	
0006	Volt	2V	-2.0000	2.0000	Off	
0007	Volt	2V	-2.0000	2.0000	Off	

Icon  
Channel number  
Setup item

CH	On/Off	Type	Value	Hysteresis	Log
0001	<input type="checkbox"/>	H: High limit	0.0000	0.0005	<input type="checkbox"/>
0002	<input type="checkbox"/>	H: High limit	0.0000	0.0005	<input checked="" type="checkbox"/>

Click the icon to clear the list box.

### 3.1.6 Saving and Loading Settings and Saving and Loading Various Files

This section explains how to save and load setting parameters. Note that you cannot display, save, or load setting parameters on a GX/GP whose advanced security function (/AS) is enabled.

#### Saving GX/GP Settings

You can save the GX/GP setting parameters to an SD memory card or to USB flash memory.

- 1 On the **Data** tab, click **Save load**.  
The save/load screen appears. The folders <sup>1</sup> and files on the SD memory card are displayed.  
1 Folders that have single quotation marks or semicolons in their names are not displayed.
- 2 Select **SD** or **USB** from the **Folder** list. The folders and files on the selected folder are displayed.

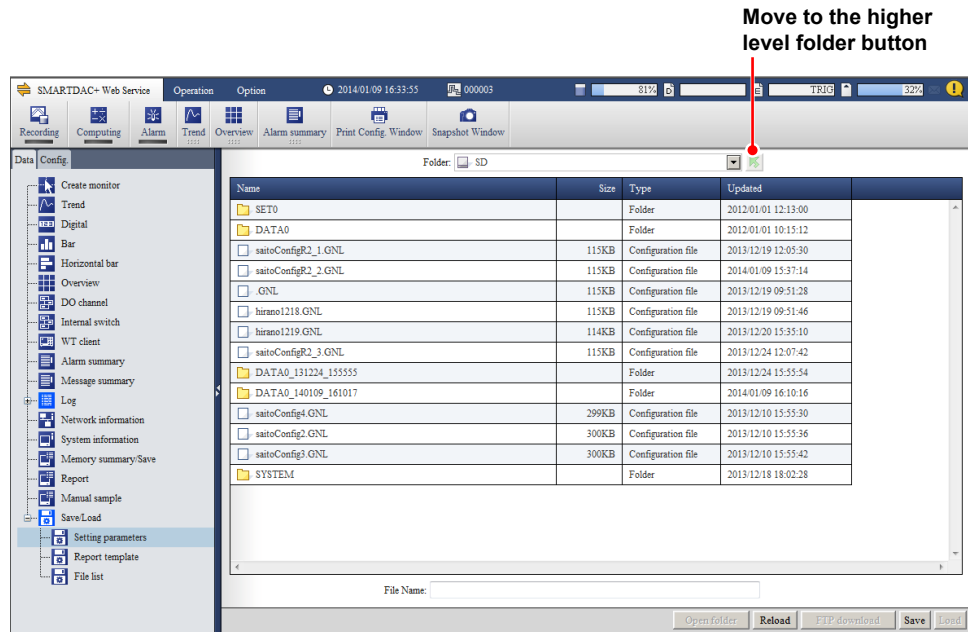

- 3 Click a column title to sort the items in ascending or descending order of that column.
- 3 Select the save destination folder.  
Double-click a folder to show the folders and files in that folder. Click the “move to the higher level folder” button to move to the higher level folder.
- 4 Enter the file name in the **File Name** text box. You do not have to enter the extension. You can also click a file in the list to display the file name in the **File Name** text box.
- 5 Click **Save**.  
The **Save as configuration file** dialog box appears.
- 6 Enter a command, and click **Save**.  
To not save, click **Cancel**.  
The setting parameters are saved, and the **Save as configuration file** dialog box closes.

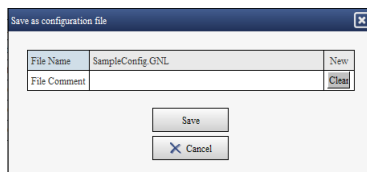

### 3.1 Using the Web Application to Change the GX/GP Settings, Monitor Data, and Control the GX/GP (Web server function)

#### Note

- Folders and files are not displayed if their names contain single quotation marks or semicolons.
- If a file with the same name exists, an overwrite confirmation message is displayed.

### Loading Settings into the GX/GP

You can load GX/GP setting parameters from an SD memory card or USB flash memory into the GX/GP.

- 1** On the **Data** tab, click **Save load**.  
The save/load screen appears. The folders and files on the SD memory card are displayed.
- 2** Select **SD** or **USB** from the **Folder** list. The folders and files on the selected folder are displayed.
- 3** Select the file you want to load.  
The selected file name appears in the **File Name** text box.  
  
If you double-click the file name, the **Load from configuration file** dialog box appears. In this case, proceed to step 5.
- 4** Click **Load**.  
The **Load from configuration file** dialog box appears.
- 5** Specify what types of settings to load into the GX/GP using On and Off. Settings that are set to On will be loaded.
- 6** Click **Load**.  
To not load, click **Cancel**.  
The setting parameters are applied to the GX/GP, and the **Load as configuration file** dialog box closes.

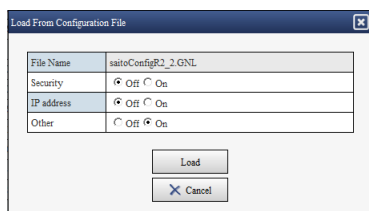

#### Note

- Folders and files are not displayed if their names contain single quotation marks or semicolons.
- It is possible that as a result of loading setting parameters, the Web application no longer runs properly or the GX/GP restarts automatically.

### Downloading Files

You can download files in the SD memory card or USB flash memory to your PC.

- 1** Under Save/Load on the Data tab, show the screen containing the file you want to download.
- 2** Select the file you want to download.  
The selected file name appears in the File Name text box.
- 3** Click **Download**.  
Follow the instructions in the dialog box that appears.



### Saving and Loading Report Templates

You can save the report templates stored in the GX/GP to an SD memory card or USB flash memory. You can also load the report templates from an SD memory card or USB flash memory into the GX/GP.

On the **Data** tab, click **Save/Load** and then **Report template**. The save/load screen appears.

For the procedure, see “Saving GX/GP Settings” and “Loading Settings into the GX/GP.”

### Viewing the Template Information

Select a template file and click **Template information** to open the Template information dialog box.

### Downloading Files

See “Downloading Files” provided earlier.

### Displaying a List of Files

You can list the files in the SD memory card or USB flash memory. The files that are displayed are setting files, event data files, display data files, report files, Excel files, manual sampled data files, alarm summary data files, PDF files, and PDF printer files.

On the **Data** tab, click **Save/Load** and then **File list**. A File list screen appears.

### Downloading Files

See “Downloading Files” provided earlier.

### Saving All the Data <sup>1</sup> in the Internal Memory

You can save all the data in the internal memory to an SD card or USB flash memory.

<sup>1</sup> Display and event data, manual sample data, and report data.

- 1** On the **Data** tab, click **Save/Load** and then **File list(Save all/Load all)**. A File list screen appears.
- 2** Click **All save**. An All save dialog box appears.
- 3** Select the save destination. The data is saved.

### Data Save Destination

The GX/GP will create a new directory to store the data in each time you save data.

Directory name: Specified string\_YYMMDD\_HHMMSS (the values of YY to SS are the date and time of operation)

Example: DATA0\_141205\_184500

You can set the “specified string” by clicking Data save settings on the Setting tab.

After saving is complete, click Reload to display the save destination directory.

### Save all

- 1** Select the **Data** tab > **Save/Load** > **File list(Save all/Load all)**.  
A File list screen appears.
- 2** Click **Save all settings**.  
A Save all settings dialog box opens.
- 3** Enter the folder name in the **Folder Name** text box.
- 4** Click **OK**.  
All the files are saved.  
Setting parameters, scale images, report templates, trusted certificates, server certificates, and custom displays are saved.

### Load all

- 1** Select the **Data** tab > **Save/Load** > **File list(Save all/Load all)**.  
A File list screen appears.
- 2** Select the folder you save using **Save all settings** to open it.
- 3** Click **Load all settings**.  
A Load all settings dialog box opens.
- 4** Click **OK**.  
All the files are loaded.  
Setting parameters, scale images, report templates, trusted certificates, and custom displays are loaded.

### Printing the Settings

You can print the GX/GP settings.  
 On the **SMARTDAC+ Web Service** tab, click **Print Config. Window**.  
 The setup print window appears.

<b>Settings</b>								
PC time	2014/01/09 16:11:41							
Hardware time	2014/01/09 16:54:38							
Comment								
<b>System Information</b>								
Basic Information								
Product Name	GX10/GP10							
Serial No.	XXXXXXXXXX							
MAC Address	XXXXXXXXXX							
Firmware Version	R0.10.08							
Main Program	R0.10.08							
Web Program	R2.00008							
Model	GX10							
Option	RS-422/485 Fail output, Ipoint Mathematical function (with report function) Comm. channel function U SB interface (Host 2 ports) EtherNet/IP W.T communication Custom display function Log scale							
Instruments tag								
Instruments tag No.								
Channel Information	All 16Ch / DI 16Ch / DO 6Ch / Math 50Ch / Communication 50Ch							
<b>Recognized Module</b>								
ID	Status	Model	Serial No.	Version	Option	Custom	Input Ch.	Output Ch.
0	GOOD	GX90XA-10-12	XXXXXXXXXX	R0.03.04		Standard	10	0
1	GOOD	GX90XD-16-11		R0.03.04		Standard	16	0
2	GOOD	GX90YD-06-11		R0.03.04		Standard	0	6
<b>Connected Module</b>								
ID	Model	Serial No.	Version	Option	Custom	Input Ch.	Output Ch.	Error
0	GX90XA-10-12	XXXXXXXXXX	R0.03.04		Standard	10	0	
1	GX90XD-16-11		R0.03.04		Standard	16	0	
2	GX90YD-06-11		R0.03.04		Standard	0	6	
<b>Network Information</b>								
Ethernet								
IP Address	XXXXXXXXXX							
Subnet Mask	XXXXXXXXXX							
Default Gateway	XXXXXXXXXX							

- You can enter a comment in the Comment box.
- Items whose check boxes are selected under **Print setting** will be printed. Clear the check boxes for the items you do not want to print.
- The password is displayed using asterisks.
- Click the browser's Refresh button to refresh the displayed information.
- The information is displayed in the specified display language (see page 3-60 in section 3.1.7, "Changing the Display Settings on the Browser").

Print using the browser's print feature.

**Note**

The setup print window will work properly only when it is opened from the Web application. When you close the Web application, close also the setup print window.

### 3.1.7 Changing the Display Settings on the Browser

You can change the display language on the browser and add and delete monitor display switch buttons on the menu bar.

- 1 On the **Option** tab, click **Web Option**.  
A Display Option dialog box appears.
- 2 The Display Option dialog box appears. Change the settings, and click **OK**.  
For procedure to change the settings, see the explanation below.

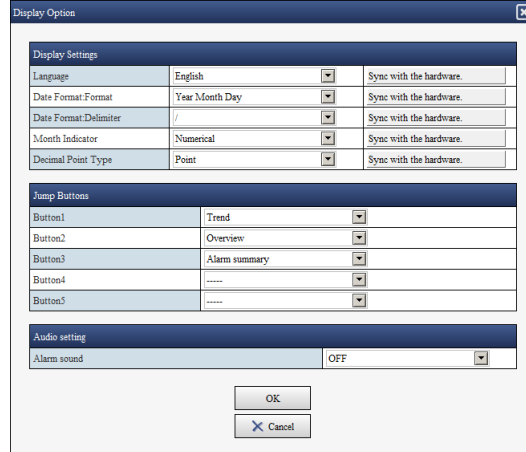

#### Language

Select the language from the list. Click **Get info. from Hardware** to obtain the setting from the GX/GP and reflect it in the text box.

#### Note

If you change the language, the Web application will restart.

#### Date Format: Format

Select the format from the list. Click **Get info. from Hardware** to obtain the setting from the GX/GP and reflect it in the text box.

#### Date Format: Delimiter

Select the delimiter for the year, month, and day from the list. Click **Get info. from Hardware** to obtain the setting from the GX/GP and reflect it in the text box.

#### Month Indicator

To display the month as words, select the check box. Click **Get info. from Hardware** to obtain the setting from the GX/GP and reflect it in the check box. You cannot select this setting when the language is set to Japanese, Chinese, or Korean.

#### Display Type of Decimal Point

Select the decimal point type from the list. Click **Get info. from Hardware** to obtain the setting from the GX/GP and reflect it in the text box.

#### Jump Buttons

You can add up to five monitor display switch buttons to the menu bar. From the **Button1** to **Button5** lists, select the monitor display switch buttons you want to add. Select ----- if you do not want to specify a jump button.

### 3.1 Using the Web Application to Change the GX/GP Settings, Monitor Data, and Control the GX/GP (Web server function)

#### Alarm Sound

If you select ON, the PC will generate an alarm sound when an alarm occurs.

- This function is enabled when in System settings, under Alarm basic settings, Indicator's Hold/Nonhold is set to Hold.
- The alarm sound stops when you acknowledge the alarm on the GX/GP or Web application.

#### Buzzer

This appears if the aerospace heat treatment (/AH) is installed.

If **Buzzer On/Off** in calibration reminder settings is enabled and you select On, the PC generates a buzzer sound.

Even when **Buzzer On/Off** in calibration reminder settings is enabled, if Alarm sound is set to Off, the PC will not generate a buzzer sound.

#### Note

In Chrome, you have to click on the screen 1 or more times to play the alarm or buzzer. To configure Chrome to play without having to click, do the following:

1. Type the following into the Chrome address bar and then press Enter.  
chrome://flags/#autoplay-policy
2. Under Autoplay policy, select No user gesture is required.

### 3.1.8 Changing the Password

The user that is logged in can change his or her password.

- 1 On the **Option** tab, click **Password change**.  
A Password change dialog box appear.
- 2 Enter the password, and click **Update**.  
The password will be changed. Use the new password for subsequent logins.

Password change	
User name	User01
Old Password	
New Password	
New Password Again	
<input type="button" value="Update"/>	
<input type="button" value="X Cancel"/>	

---

## 3.2 Transmitting E-mail Messages

This section explains how to configure e-mail transmission settings.

### 3.2.1 Configuring the SMTP Client Function

The SMTP client function is used to send E-mail from the GX/GP.

#### Description

- **Enable the SMTP client function**
  - **Set the user authentication method**  
Set the authentication method when user authentication is necessary.
  - **Specify the SMTP server settings**
  - **Specify the POP3 server settings**  
Specify the necessary settings when the user authentication method is POP3 (POP before SMTP).
- ▶ For details on the settings, see page 1-186 in section 1.21.3, “Configuring the SMTP Client Function”.

### 3.2.2 Setting the Mail Content

#### Description

- **Set the mail header**
  - **Set the mail content**
  - **Set alarm notification mail**  
Specify the necessary settings to send e-mails when alarms occur and are released.
  - **Set report generation notification mail**  
Specify the necessary settings to send e-mails when reports are generated.
  - **Set periodic mail**  
Specify the necessary settings to send periodic e-mails .
  - **Send mail when the power is turned on, when the GX/GP recovers from a power failure, when the memory is full, or when an error occurs**
- ▶ For details on the settings, see page 1-187 in section 1.21.4, “Setting E-mail Transmission Conditions (When the SMTP client function is on)”.

**Explanation****Transmitting E-mail Messages**

The available types of e-mails are listed below. E-mail can be automatically transmitted for each item. You can specify two groups of destinations and specify the destination for each item. In addition, you can set a header string for each item.

- Alarm notification mail  
Sends alarm information when an alarm occurs or clears or reports alarm information only when an alarm occurs.  
When the measurement mode is Dual interval, there is no distinction as to whether the alarm occurred on measurement group 1 or measurement group 2.
- Future alarm notification mail  
Sends alarm information when a future alarm occurs or clears or reports alarm information only when an alarm occurs.
- Power failure notification mail  
Sends the time of power failure and time of recovery when the GX/GP recovers from a power failure.
- Memory full notification mail  
Sends a message when the free space on the external storage medium or internal memory is low.  
▶ For details, see the explanation on page 1-211 in section 1.23.6, "Setting the FAIL Relay and Instrument Information Output (/FL option)".
- System error notification mail  
Sends an error code and message when an external storage medium error, internal memory error, or FTP client error occurs.
- Periodic notification mail  
Sends a message when the specified time is reached. This can be used to confirm that the e-mail transmission function including the network is working properly. You can specify the reference time and the e-mail transmission interval for each destination.
- Report notification mail (only on models with the math function (/MT option))  
Sends report results.
- User lockout notification mail (only on models with the advanced security function (/AS option))  
Sends a list of invalidated users.

**Example of an e-mail sent periodically**

<pre>Date: Wed, 12 Nov 2012 08:00:45 +0900 (JST) [From: GX20@smartdacplus.com To: user1@smartdacplus.com, user2@daq.co.jp Subject: [Periodic data] subject MIME-Version: 1.0 Content-Type: text/plain; charset="iso-8859-1" Content-Transfer-Encoding: base64  TEMPERATURE  Periodic notification &lt;Host name&gt; GX20  &lt;Time&gt; 2012/12/12 08:00:01</pre>	<p><b>Subject</b></p> <p><b>Header 1</b></p>
--	--

**3.2.3 Performing an Mail Transmission Test**

- ▶ For the procedure, see page 2-81 in section 2.7.1, "Performing an Mail Transmission Test".

**3.2.4 Starting and Stopping E-mail Transmission**

- ▶ For the procedure, see page 2-81 in section 2.7.2, "Starting and Stopping Mail Transmission".





**Future Alarm Notification Mail Format**

- Subject  
Subject [Future\_Alarm\_Summary]sss...s-ttt...t
- Syntax
 

Header block	headerCRLF CRLF
General block	Future_Alarm_notificationCRLF <Host name> or <IP Address>CRLF hostCRLF CRLF
Alarm information	<CH>ccc...cCRLF <Type>lqCRLF <aaa>yyy/mo/dd_hh:mi:ssCRLF (Time of predicted future waveform at the time of occurrence) <Predicted value>fff...fuuu...uCRLF (Event data) <Predicted value>ggg...g/bbb...buuu...uCRLF (Display/Display+Event) CRLF : CRLF
Instantaneous data	<Inst. value>CRLF yyyy/mo/dd_hh:mi:ssCRLF ccc...c=ddd...duuu...uCRLF : CRLF
Source URL	Access_the_following_URL_in_order_to_look_at_a_screen. CRLF http://host.domain/CRLF CRLF
- Display item description**

ttt...t	Tag number or channel number (when tag or channel is attached to the header)
ccc...c	Tag number, tag, or channel number (Channels set to skip or off are not output.)
lq	Alarm level (1 to 4) Alarm type (H, L, h, l) H (high limit alarm), L (low limit alarm), h (difference high limit alarm), l (difference low limit alarm)
aaa	Alarm status (On, Off)
ddd...d	Measured value, computed value (up to 10 digits including the sign and decimal point) +OVER (positive overflow) -OVER (negative overflow) Burnout ***** (error data)
fff...f	Predicted value for event data (up to 10 digits including the sign and decimal point)
ggg...g	Predicted minimum value for display data (up to 10 digits including the sign and decimal point)
bbb...b	Predicted maximum value for display data (up to 10 digits including the sign and decimal point)

The GX/GP transmits channel numbers, alarm types, and alarm statuses for up to 10 events in a single e-mail. If the GX/GP is configured to include a tag number or a channel number in the e-mail subject, one e-mail is sent for each event.

**Periodic Notification Mail Format**

- Subject  
 Subject                                    [Periodic\_data]sss...s
  
- Syntax
 

Header block	headerCRLF CRLF
General block	Periodic_notificationCRLF <Host name> or <IP Address>CRLF hostCRLF CRLF
Time information	<Time>CRLF YYYY/mo/dd_hh:mi:ssCRLF CRLF
Cancellation information	E-mail message(s) did not reach intended recipient(s). CRLF [ttt...t]CRLF Count = nnn...nCRLF YYYY/mo/dd_hh:mi:ssCRLF CRLF : CRLF
Instantaneous data	<Inst. value>CRLF YYYY/mo/dd_hh:mi:ssCRLF ccc...c=ddd...duuu...uCRLF : CRLF
Source URL	Access_the_following_URL_in_order_to_look_at_a_screen. CRLF http://host.domain/CRLF CRLF
  
- Display item description**

ccc...c	Tag number, tag, or channel number (Channels set to skip or off are not output.)
ttt...t	Canceled mail type Alarm_summary (alarm notification mail) Periodic_data (periodic notification mail) System_warning (system error notification mail) Power_failure (power failure notification mail) Memory_full (memory full notification mail) Report_data (report notification mail)
nnn...n	Number of canceled mails
ddd...d	Measured value, computed value (up to 10 digits including the sign and decimal point) +OVER (positive overflow) -OVER (negative overflow) Burnout ***** (error data)

The time that follows the type and count of canceled mails is the time when the mail is canceled last.

**Power Failure Notification Fail Format**

- Subject  
Subject                                    [Power\_failure]sss...s
- Syntax
  - Header block                            headerCRLF  
    CRLF
  - General block                           <Power failure notification>CRLF  
   <Host name> or <IP Address>CRLF  
   hostCRLF  
   CRLF
  - Power supply information            <Power\_failure>CRLF  
   yyyy/mo/dd\_hh:mi:ssCRLF  
   CRLF  
   <Power\_recovery>CRLF  
   yyyy/mo/dd\_hh:mi:ssCRLF  
   CRLF
  - Source URL                             Access\_the\_following\_URL\_in\_order\_to\_look\_at\_a\_screen.CRLF  
   http://host.domain/CRLF  
   CRLF

**Memory Full Notification Mail**

- Subject  
Subject                                    [Memory\_full]sss...s
- Syntax
  - Header block                            headerCRLF  
    CRLF
  - General block                           Memory full notificationCRLF  
   <Host name> or <IP Address>CRLF  
   hostCRLF  
   CRLF
  - Memory information                   yyyy/mo/dd\_hh:mi:ssCRLF  
   <Memory\_remain>ppp...pMbytesCRLF  
   <File number>bbb/500CRLF  
   <Medium\_remain>rrr...rMbytesCRLF  
   CRLF
  - Source URL                             Access\_the\_following\_URL\_in\_order\_to\_look\_at\_a\_screen.CRLF  
   http://host.domain/CRLF  
   CRLF
- Display item description**
  - ppp...p                                Remaining space in internal memory
  - bbb                                     Number of unsaved files (0 to 500)
  - rrr...r                                Remaining space on external storage medium

### System Error Notification Mail Format

- **Subject**  
Subject [System\_warning]sss...s
- **Syntax**  
Header block headerCRLF  
CRLF  
General block System error notificationCRLF  
<Host name> or <IP Address>CRLF  
hostCRLF  
CRLF  
Error information yyyy/mo/dd\_hh:mi:ssCRLF  
<ERROR>fffCRLF  
mmm...mCRLF  
CRLF  
Source URL Access\_the\_following\_URL\_in\_order\_to\_look\_at\_a\_screen.CRLF  
http://host.domain/CRLF  
CRLF
- **Display item description**  
fff Error number (234, 501, 502, 507, 511, 692, 693, 695, 696, 698, 699, 921)  
mmm...m Error message

The error message varies depending on the error type.

**Report Notification Mail Format**

- Subject
    - Subject `[rrr...r]sss...s`
  - Syntax
    - Header block `headerCRLF`
    - `CRLF`
    - General block `tiCRLF`
    - `<Host name> or <IP Address>CRLF`
    - `hostCRLF`
    - `CRLF`
    - Report information `yyyy/mo/dd_hh:mi:ssCRLF`
    - `<CH>ccc...cCRLF`
    - `<tp>eee...eCRLF`
    - `<tp>eee...eCRLF`
    - `<tp>eee...eCRLF`
    - `<tp>eee...eCRLF`
    - `<tp>eee...eCRLF`
    - `<Unit>uuu...uCRLF`
    - `CRLF`
    - `:`
    - `CRLF`
    - Source URL `Access_the_following_URL_in_order_to_look_at_a_screen.CRLF`
    - `http://host.domain/CRLF`
    - `CRLF`
- Display item description**
- |                      |  |
|----------------------|--|
| <code>rrr...r</code> | Report mail content (Hourly report, Daily report, Weekly report, Monthly report, Batch report, Daily custom report)  |
| <code>ti</code>      | Report mail content (hourly, daily, weekly, monthly, batch, and daily-custom)  |
| <code>tp</code>      | Report content (average, maximum, minimum, sum, and instantaneous; five items from these are output)   |
| <code>ccc...c</code> | Tag number, tag, or channel number<br>(Channels set to off are not output.)  |
| <code>eee...e</code> | Measured value, computed value (up to 10 digits including the sign and decimal point). However, for the sum value, the value is output as a combination of the sign, mantissa, E, sign, and exponent such as in -3.800000E+02.<br>+OVER (positive overflow)<br>-OVER (negative overflow)<br>***** (error data) |

### Test Mail Transmission Format

- Subject  
Subject [Test]sss...s
- Syntax
  - Header block headerCRLF  
CRLF
  - General block Test\_mailCRLF  
<Host name> or <IP Address>CRLF  
hostCRLF  
CRLF
  - Time information <Time>CRLF  
yyyy/mo/dd\_hh:mi:ssCRLF  
CRLF

### User Lockout Notification Format

- Subject  
Subject [User\_lockout]sss...s
  - Syntax
    - Header block headerCRLF  
CRLF
    - General block User\_lockout\_notificationCRLF  
<Host name> or <IP Address>CRLF  
hostCRLF  
CRLF
    - User lock out information yyyy/mo/dd\_hh:mi:ssCRLF  
<User name>CRLF  
uuu...uCRLF  
:  
CRLF
    - Source URL Access\_the\_following\_URL\_in\_order\_to\_look\_at\_a\_screen.CRLF  
http://host.domain/CRLF  
CRLF
- Display item description**  
uuu...u User name

### Display Items Common to All Formats

sss...s	Subject
uuu...u	Unit (except for user lockout notifications)
YYYY	Year (2001 to 2035)
mo	Month (01 to 12)
dd	Day (01 to 31)
hh	Hour (00 to 23)
mi	Minute (00 to 59)
ss	Second (00 to 59)
header	Header
host	Host name or IP address (IP address when the host name is not assigned.)
domain	Domain name
_	Space
CRLF	Line feed

**Channel Number Notation and Range**

Type	Model	Notation and Range	Notes
I/O channel	GX10/GP10	0001 to 0299 <sup>1</sup>	Depends on the installed module
	GX20/GP20	0001 to 0999 <sup>2</sup>	
Math channel	Expandable I/O	1001 to 6599	/MT option
	GX10/GP10	A001 to A050	
Report channel	GX20/GP20	A001 to A100	/MT option
	GX10/GP10	R01 to R50	
Communication channel	GX20/GP20	R01 to R60	/MC option
	GX10/GP10	C001 to C050	
	GX20-1/GP20-1	C001 to C300	
	GX20-2/GP20-2	C001 to C500	

- 1 0001 to 0199 when the expandable I/O is connected
- 2 0001 to 0899 when the expandable I/O is connected

## 3.3 Accessing the Measurement Data File on the GX/GP from a PC (FTP server function)

You can use a PC to access the GX/GP via FTP. You can perform operations such as retrieving directory and file lists from the external storage medium (SD memory card) of the GX/GP and transferring and deleting files. In addition, you can also retrieve the directory or file list and transfer files in the internal memory.

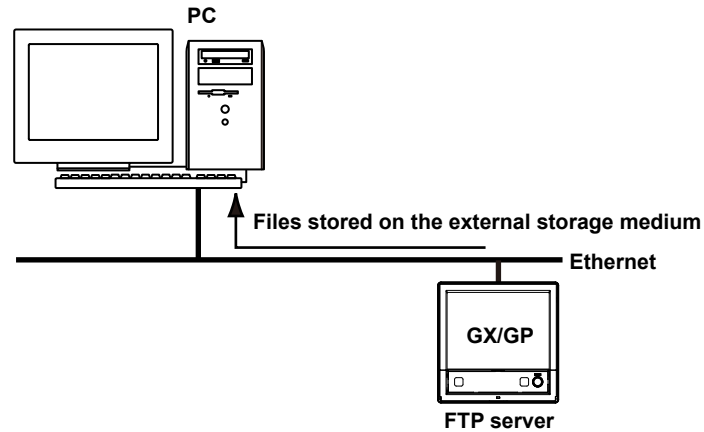

### 3.3.1 Configuring FTP Server Settings

#### Description

- **Enable the FTP server function**
  - **Set the FTP server directory output format**
- For details on the settings, see page 1-196 in section 1.21.9, “Setting the Server Functions to Use (FTP, HTTP, SNTP, MODBUS, GENE, DARWIN compatible communication)”.

### 3.3.2 Accessing the GX/GP from a PC

#### When Not Using the Login Function

Access the GX/GP from a PC via FTP using the admin, user, or anonymous account.

With the admin account, you can

- Retrieve directory and file lists from the external storage medium and transfer and delete directories and files on the external storage medium.
- Retrieve directory and file lists from the internal memory and transfer directories and files in the internal memory.

With the user or anonymous account, you can

- Retrieve directory and file lists from the external storage medium.



### Connecting from a PC via the FTP

An example of retrieving files using a browser is described below. In the Address box, enter ftp://host name.domain name. Drag the data you want to retrieve from the /MEM0/DATA folder in the case of internal memory data or the /DRV0 folder in the case of data on the external storage medium to the PC. You can also use the IP address in place of the “host name.domain name.”

### When Using the Login Function (Standard)

In the Address box, enter ftp://user name@host name.domain name/.

- Internal memory: ftp://username@hostname/MEM0/DATA
- External media: SD card: ftp://username@hostname/DRV0/

You will be prompted for a user name and password when you access the server. Enter a user name and password that are registered on the GX/GP to connect to it.

To specify the password, append [:password] to the user name.

Example:

Internal memory: ftp://username:password@hostname/MEM0/DATA

### Note

- **Memory** is linked to ftp://hostname/MEM0/DATA.
- **External media: SD memory card** is linked to ftp://hostname/DRV0/.
- **External media: USB** is linked to ftp://hostname/USB0/.
- You cannot retrieve data files that are being created.
- You must access using “ftps://” when SSL encryption is in use.

## 3.4 Transferring Data Files from the GX/GP (FTP client function)

The display data, event data, report data, snapshot data, alarm summary data, and manual sample data files or setting files that are created in the internal memory of the GX/GP can be automatically transferred via FTP when the files are created.

You can specify two file transfer destinations (FTP servers): primary and secondary. If the primary FTP server is down, the file is transferred to the secondary FTP server.

If the report template function is in use, report files in Excel format and report files in PDF format that are created in the external storage medium of the GX/GP can be automatically transferred when the files are created.

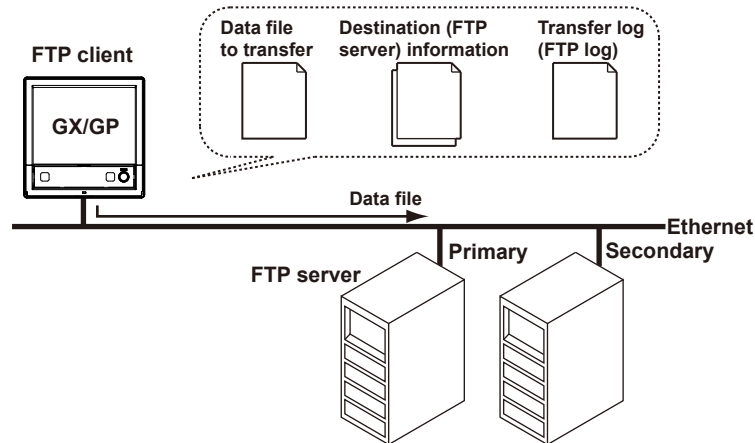

### 3.4.1 Configuring the FTP Client Function

#### Description

- **Enable the FTP client function**
  - **Set the files to transfer**  
Set the files that will be transferred automatically.
  - **Set the transfer wait time**  
Set the transfer wait time if you want to delay data transfers to the FTP server.
  - **Set the destinations (primary and secondary)**  
Set the connection destination FTP servers.
- For details on the settings, see page 1-184 in section 1.21.2, “Configuring the FTP Client Function”.

## Explanation

### Files to Transfer via FTP

Data other than Excel report files, PDF report files, and setting files are automatically transferred regardless of whether the external storage medium is available.

File Type	Description
Display data file	Data files are automatically transferred at each file save interval. <sup>3</sup>
Event data file	Files are automatically transferred when the data length of data is recorded. <sup>3</sup>
Report data file	When the file division mode is <b>Separate</b> or <b>Combine</b> , data files are automatically transferred when a report file is closed (or divided). For example, data files are transferred once per month for daily+monthly reports when the file division mode is <b>Combine</b> . Report data files based on report templates (Excel report file, PDF report file) are also automatically transferred when they are created. <sup>1</sup> ► For details on <b>Separate</b> and <b>Combine</b> , see page 1-151 in section 1.16.1, "Setting the Report Type, Creation Time, Data Type, Etc."
Snapshot data file	Files are automatically transferred when a snapshot is taken. <sup>2</sup>
Alarm summary data file	Files are automatically transferred when alarms are saved.
Manual sample data file	Files are automatically transferred when the next time manual sample is executed <sup>2</sup> and the file is divided.
Setting file at the time of the setting change	The setting file in the SD memory card is automatically transferred when settings are changed. <sup>1,4</sup>

- Files will not be transferred automatically if the remaining space on the SD memory card is low or if the SD memory card is not connected.
- Refers to an action triggered through touch screen operation, communication command (OExecRec), or event action function.
- If the FTP transfer timing is set to Sign in on models with the advanced security function (/AS option), files are transferred automatically after they are signed. See section 2.2.4, "Configuring the Sign in Settings," in the Advanced Security Function (/AS) User's Manual (IM 04L51B01-05EN).
- Only on models with the advanced security function (/AS option).

### Shifting the Transfer Time

There may be cases when data cannot be transferred from the GX/GP to the FTP server due to too many simultaneous connections to the FTP server. An example is when multiple files are created and need to be transferred at the same time from multiple GX/GPs. By shifting the transfer time, you can avoid having too many simultaneous connections to the FTP server. You can shift the transfer time for display data files, event data files, and report files.

- Even if a new event that requires an FTP transfer occurs while the GX/GP is waiting to transfer the data of the previous event, it does not affect the transfer wait time of the previous event. When the transfer shift time passes, all data files of the same type that have been created (all of the files that have not been transferred) are transferred via FTP. The following figure is an example for display data.
- To avoid accumulating too many files that have not been transferred, we recommend that you set the transfer wait time shorter than the interval at which events that require FTP transfers occur.

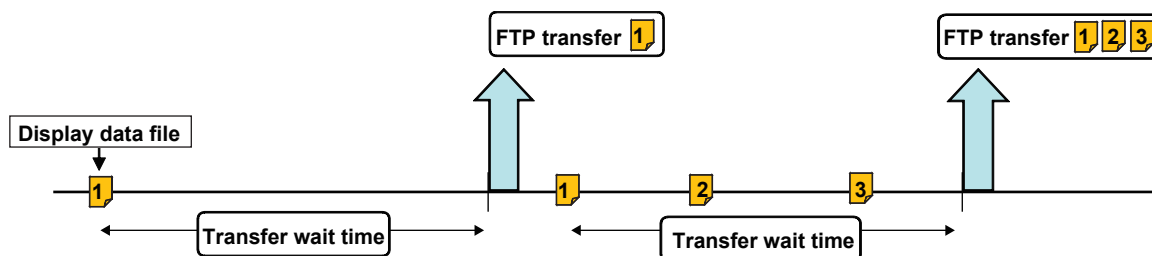

#### **Transfer Operation**

- Even if you turn the power off during FTP transfer wait time, the elapsed time is recorded.
- If you change the FTP transfer time settings during FTP transfer wait time, the data files that are being held are transferred using the previous setting. Subsequent data files are sent according to the new setting.
- If you execute FTP function to Off, or "Initialize all" during a FTP transfer wait time, the elapsed time is cleared.
- If the FTP transfer timing is set to Sign in on models with the advanced security function (/AS option), transfer wait time for display data files and event data files is invalid.

#### **When There Is a File with the Same Name at the Transfer Destination**

Under all circumstances, when there is a file with the same name at the transfer destination, it is overwritten.

#### **Operation When the Data Transfer Fails**

If the GX/GP fails to transfer files to both the primary and secondary FTP servers, the GX/GP aborts the file transfer operation. If the connection to the destination recovers, the GX/GP transfers new data files along with the files that the GX/GP failed to transfer (except for snapshot data files, alarm summary data files, and manual sample data files). Note that because the GX/GP transfers data from its internal memory, if the data that the GX/GP failed to transfer is overwritten, it is lost.

### **3.4.2 Testing the FTP Transfer**

You can check whether files can be sent from the GX/GP to the FTP server using a test file.

- ▶ For the procedure, see "page 2-82 in section 2.7.3, "Checking FTP File Transfers (FTP transmission test)"

## 3.5 Synchronizing the Time (SNTP client function)

The GX/GP time can be synchronized to the time on an SNTP server (time information server on the network).

The GX/GP can retrieve time information from a specified SNTP server at specified intervals.

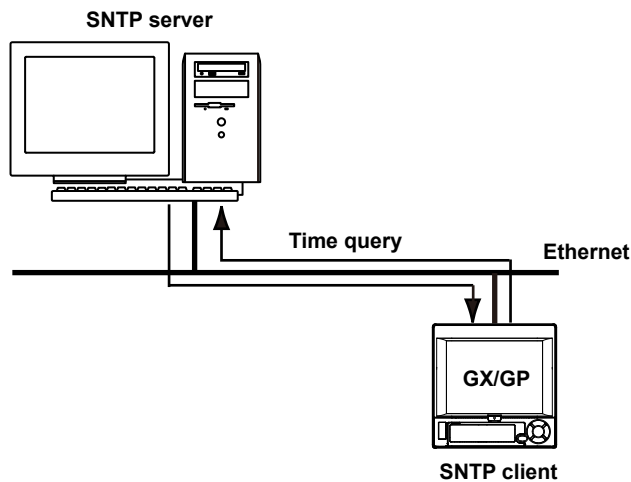

### 3.5.1 Configuring the SNTP Client Function

#### Description

- Enable the SNTP client function
- Specify the SNTP server settings
- Set the query operation

▶ For setup details, see page 1-190 in section 1.21.5, “Setting the SNTP Client Function”.

### 3.5.2 Adjusting the Clock Manually

#### Procedure

You can adjust the clock manually. The SNTP client must be enabled.

- ▶ For operating instructions, see page 2-82 in section 2.7.4, “Adjusting the Clock Manually (SNTP time adjustment)”.

## 3.6 Transmitting Time Information from the GX/GP to SNTP Client Devices (SNTP server function)

The GX/GP can operate as an SNTP server. When an SNTP client device on the network queries the GX/GP for time information, the GX/GP sends the information.

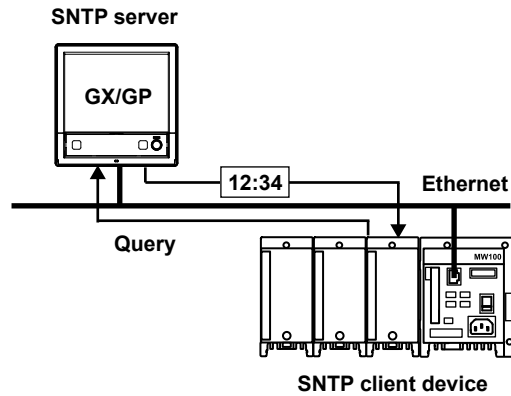

### 3.6.1 Configuring the SNTP Server Function

#### Description

##### Enabling the SNTP Server Function

- For details on the settings, see page 1-196 in section 1.21.9, "Setting the Server Functions to Use (FTP, HTTP, SNTP, MODBUS, GENE, DARWIN compatible communication)".

## 4.1 Using Modbus/TCP to Enable Other Devices to Read Data from and Write Data to the GX/GP (Modbus server function)

The Modbus function is used by the GX/GP and external Modbus devices to perform communication and data reading and writing.

The GX/GP can operate as a Modbus server. The maximum number of simultaneous connections is 4.

Other devices (Modbus client devices) can carry out the following operations on the GX/GP.

- Read I/O channel and math channel (/MT option) data
- Read communication channel (/MC option) data
- Write data to communication channels
- Start and stop recording, write messages, and perform other operations
- Load the recording start/stop condition, message strings, and other types of data

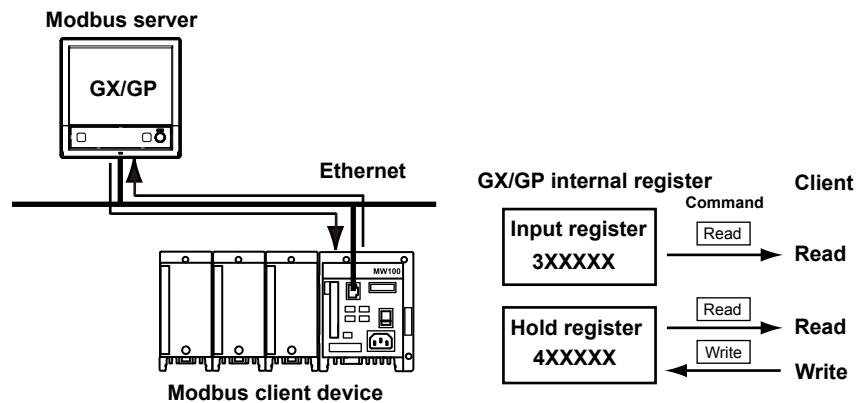

### 4.1.1 Setting Basic Network Communication Conditions

#### Description

- Obtain the IP address automatically
  - Set the IP address manually (when automatic IP address assignment is set to Off)
- For details on the settings, see page 1-182 in section 1.21.1, “Setting Basic Communication Conditions”.

### 4.1.2 Configuring the Modbus Server Function

#### Description

#### Enabling the Modbus Server Function

- For details on the settings, see page 1-196 in section 1.21.9, “Setting the Server Functions to Use (FTP, HTTP, SNTP, MODBUS, GENE, DARWIN compatible communication)”.

#### Applying Modbus Connection Limits

Set this function to limit the IP addresses that can connect to the GX/GP Modbus server function.

You can register up to 10 IP addresses.

- For details on the settings, see page 1-195 in section 1.21.8, “Limiting the Connection to the Modbus Server (GX/GP)”.

### 4.1.3 Reading from and Writing to the GX/GP from Other Devices

Other devices (client devices) can transmit commands to the GX/GP to read data from and write data to the GX/GP internal registers. By writing data to the GX/GP internal registers, you can control the GX/GP (such as start recording).

- ▶ For details on the function codes that the GX/GP supports and the GX/GP registers that client devices can access, see page 4-11 in section 4.5, “Modbus Function and Register Assignments”.

#### Specifying Register Numbers

On client devices, specify the GX/GP registers as follows:

- If you are using a commercial SCADA system or something similar, specify the register number (a number such as 400001; referred to as the “reference number”) listed in ▶ page 4-11 in section 4.5, “Modbus Function and Register Assignments”.
- If you are using a custom communication program, specify the “relative number” in relation to the reference number. Derive the relative number in the manner indicated in the examples below.

#### Examples

The relative number for input register 300100 is 99, which is the difference between 300100 and 300001.

$$300100 - 300001 = 99$$

The relative number for input register 400011 is 10, which is the difference between 400011 and 400001.

$$400011 - 400001 = 10$$



## 4.2 Using Modbus/TCP to Enable the GX/GP to Read Data from and Write Data to Other Devices (Modbus client function)

The Modbus function is used by the GX/GP and external Modbus devices to perform communication and data reading and writing.

The GX/GP can operate as a Modbus client. The maximum number of connectable servers is 16 for the GX20-1/GP20-1/GX10/GP10 and 32 for the GX20-2/GP20-2.

The GX/GP can connect to another device (Modbus server) via Modbus/TCP and read from and write to the device's internal registers. Read data can be handled using communication channels. Data that can be written are I/O channel data, math channel data, and communication channel data.

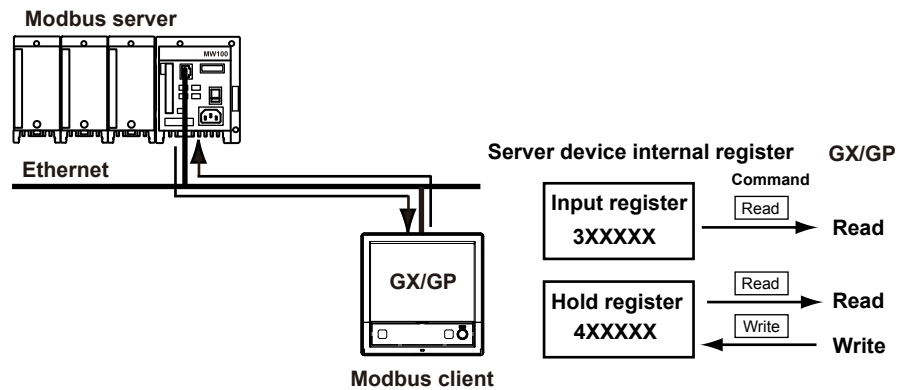

### 4.2.1 Setting Basic Network Communication Conditions

#### Description

- Obtain the IP address automatically
  - Set the IP address manually (when automatic IP address assignment is set to Off)
- For details on the settings, see page 1-182 in section 1.21.1, "Setting Basic Communication Conditions".

### 4.2.2 Configuring the Modbus Client Function

#### Description

- Enable the Modbus client function
  - Set the communication interval
  - Set the recovery action
  - Set the keep connection function
- For details on the settings, see "Configuring Basic settings" page 1-191 in section 1.21.6, "Configuring the Modbus Client Function (Option, Function available when /MC is specified)".

### 4.2.3 Configuring the destination server

#### Description

- **Set the server number**
  - **Configure the server settings**
- ▶ For details on the settings, see “Configuring the Destination Server” page 1-191 in section 1.21.6, “Configuring the Modbus Client Function (Option, Function available when /MC is specified)”.

### 4.2.4 Setting Commands

#### Description

- **Set the client command number**
  - **Set the command**
- ▶ For details on the settings, see “Setting Commands” page 1-191 in section 1.21.6, “Configuring the Modbus Client Function (Option, Function available when /MC is specified)”.
- ▶ For details on the Modbus functions and registers that the GX/GP supports, see page 4-11 in section 4.5, “Modbus Function and Register Assignments”.

#### Server Register Number

You can specify an input register in the range of 30001 to 39999 or 300001 to 365536. You can specify a hold register in the range of 40001 to 49999 or 400001 to 465536. The register numbers that you can specify vary depending on the type of command. ▶ See page 4-11 in section 4.5, “Modbus Function and Register Assignments”.

#### Specifying Register Numbers

Specify the register number on the GX/GP by using the “reference number” (such as the number 40001 written above). For example, for the YOKOGAWA UT35A digital indicating controller, the D register number corresponds to the reference number as shown in the following table.

D-Reg. No.	Ref. No.
D2001	42001

For a server that calls the register using a “relative number,” add 30001, 300001, 40001, 400001 or a similar number to obtain a reference number.

Register Type	Relative Number	Reference Number	Expression
Hold register	1004	41005	1004+40001
	14567	414568	14567+400001
Input register	0000	30001	0000+30001

**Examples of Setting Commands**

The following are command setting examples on the GX/GP when the GX/GP is a Modbus client device. If the GX/GP is a Modbus master device, substitute “master” for “client” and “slave” for “server.”

**Connection example**

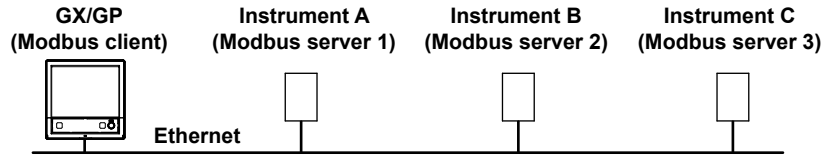

**Loading into Communication Channels**

The GX/GP enters data loaded from the server into communication channels as floating point type data.

**Example 1**

Load the 16-bit signed integer value assigned to register 30001 of instrument A to C001.



Command setting

Setup Item	Value	
Client command number	1	
Command setting	Type	Read
	Server	1
	Data type	INT16
	Register	30001
	Channel type	Communication channel
	First-CH	C001
	Last-CH	C001

**Example 2**

Load the 32-bit signed integer value assigned to registers 30003 and 30004 (little endian) of instrument B to C003. Only the smallest register number need be specified in commands.

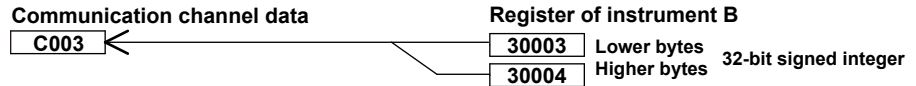

Command setting

Setup Item	Value	
Client command number	2	
Command setting	Type	Read
	Server	2
	Data type	INT32 L
	Register	30003
	Channel type	Communication channel
	First-CH	C003
	Last-CH	C003

**Example 3**

Load the 16-bit signed integer values assigned to registers 30001 and 30002 of instrument B to C001 and C002. Only the smallest register number need be specified in commands.

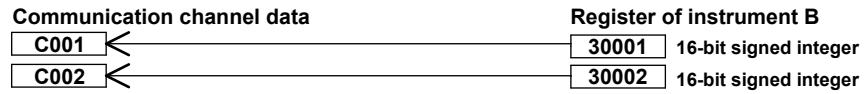

Command setting

Setup Item	Value
Client command number	3
Command setting	Type Read
	Server 2
	Data type INT16
	Register 30001
	Channel type Communication channel
	First-CH C001
	Last-CH C002

**Example 4**

Load the 32-bit floating point values assigned to registers 30005 and 30006 (little endian) of instrument B to C004. Only the smallest register number need be specified in commands.

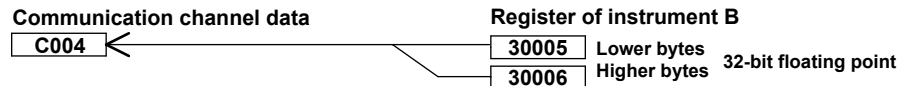

Command setting

Setup Item	Value
Client command number	4
Command setting	Type Read
	Server 2
	Data type FLOAT L
	Register 30005
	Channel type Communication channel
	First-CH C004
	Last-CH C004

**Writing Data to a Server**

**Example**

Write the measured value from channel 0001 to register 40001 of instrument A.



Command setting

Setup Item	Value
Client command number	5
Command setting	Type Write
	Server 1
	Data type INT16
	Register 40001
	Channel type I/O channel
	First-CH 0001
	Last-CH 0001

### Writing Computed Values to a Server

#### Example

Write the computed values from channel A001 to registers 40001 and 40002 of instrument A, in the order lower 16 bits/higher 16 bits. Only the smallest register number need be specified in commands.

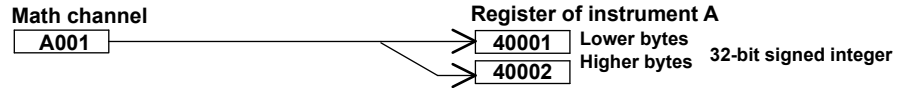

Command setting

Setup Item	Value
Client command number	6
Command setting	Type Write
	Server 1
	Data type INT32 L
	Register 40001
	Channel type Math channel
	First-CH A001
	Last-CH A001

### 4.2.5 Checking the Modbus Operation Status

#### Procedure

- ▶ For the procedure, see page 2-60 in section 2.3.6, “Checking the Command Status of the Modbus Client and Modbus Master”.

## 4.3 Using Modbus to Enable Other Devices to Read Data from and Write Data to the GX/GP (Modbus slave function)

The GX/GP can operate as a Modbus slave device.

Other devices (Modbus master devices) can carry out the following operations on the GX/GP.

- Read I/O channel and math channel (/MT option) data (input register)
- Read communication channel (/MC option) data (hold register)
- Write communication channel (/MC option) data (hold register)
- Start and stop recording, write messages, and perform other operations (using the hold register)
- Load the recording start/stop condition, message strings, and other types of data (using the hold register)

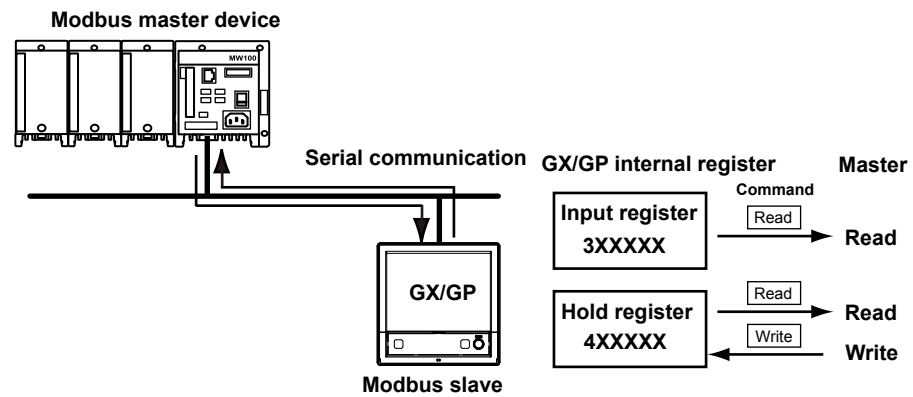

### 4.3.1 Setting Serial Communication Conditions

#### Description

- **Configure the receiver function**
  - **Set data transfer conditions**
- For details on the settings, see page 1-200 in section 1.22.1, “Setting Basic Communication Conditions”.

### 4.3.2 Reading from and Writing to the GX/GP from Other Devices

Other devices (master devices) can transmit commands to the GX/GP to read data from and write data to the GX/GP. By writing data to the GX/GP registers, you can control the GX/GP (such as start recording).

- For details on the function codes that the GX/GP supports and the GX/GP registers that master devices can access, see page 4-11 in section 4.5, “Modbus Function and Register Assignments”.

## 4.4 Using Modbus to Enable the GX/GP to Read Data from and Write Data to Other Devices (Modbus master function)

The GX/GP can operate as a Modbus master device.

The GX/GP can connect to another device (Modbus slave device) via Modbus and read from and write to the device's internal registers. Read data can be handled using communication channels. Data that can be written are I/O channel data, math channel data, and communication channel data.

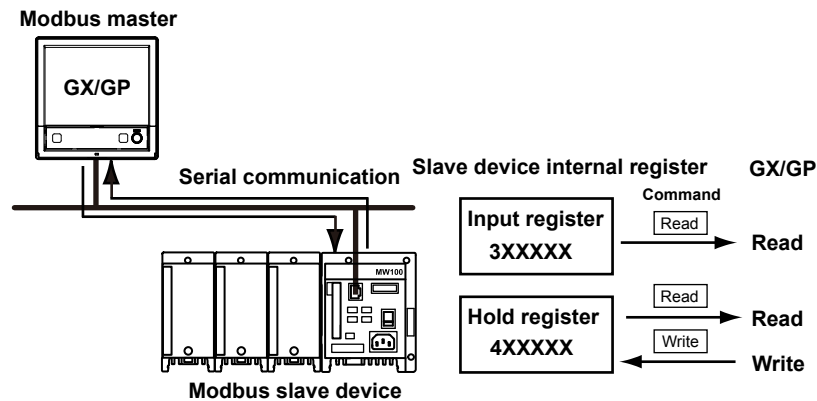

### 4.4.1 Setting Serial Communication Conditions

#### Description

- **Configure the receiver function**
  - **Set data transfer conditions**
- ▶ For details on the settings, see page 1-200 in section 1.22.1, "Setting Basic Communication Conditions".

### 4.4.2 Configuring the Modbus Master Function

#### Description

- **Enable the master function**
  - **Set communication conditions**
  - **Set the recovery action**
- ▶ For details on the settings, see page 1-202 in section 1.22.2, "Enabling or Disabling the Modbus Master Function (/MC option) and Setting Communication Conditions".
- ▶ For details on the Modbus functions and registers that the GX/GP supports, see page 4-11 in section 4.5, "Modbus Function and Register Assignments".

### 4.4.3 Setting Commands

#### Description

- **Set the master command number**
  - **Set the command**
- ▶ For details on the settings, see page 1-203 in section 1.22.3, "Setting Modbus Master Transmission Commands".
- ▶ For command setting examples, see page 4-4 in section 4.2.4, "Setting Commands".

#### **4.4.4 Checking the Modbus Operation Status**

**Procedure**

- ▶ For the procedure, see page 2-60 in section 2.3.6, “Checking the Command Status of the Modbus Client and Modbus Master”.



## 4.5 Modbus Function and Register Assignments

### 4.5.1 Modbus Client/Master Function

#### Function

The GX/GP supports the following functions.  
The server (slave) must support these functions.

Function Code	Function	Operation
1	Read the coil status (0xxxx)	The GX/GP reads the coil status of the server (slave) device.
2	Read the input relay status (1xxxx, 1xxxxx)	The GX/GP reads the input relay status of the server (slave) device.
3	Read the hold register (4XXXX, 4XXXXX)	The GX/GP reads the hold register of the server (slave) into a communication channel.
4	Read the input register (3XXXX, 3XXXXX)	The GX/GP reads the input register of the server (slave) into a communication channel.
5	Change the single coil status (0xxxx)	The GX/GP changes the single coil status of the server (slave) device (off/on).
6	Write to a single hold-register (4xxxx, 4xxxxx)	The GX/GP writes to a single hold register of the server (slave) .
15	Change the coil status (0xxxx)	The GX/GP changes the coil status of the server (slave) device (off/on).
16	Write to the hold register (4XXXX, 4XXXXX)	The GX/GP writes the I/O channel data, math channel data, or communication channel data to the hold register of the server (slave).

#### Command

Command type: Read, Write

Number of commands: GX20-1/GP20-1: Set up to 100 commands  
GX20-2/GP20-2: Set up to 200 commands  
GX10/GP10: Set up to 50 commands

Data type: See the table below.

Symbol	Description
INT16	16-bit signed integer
UINT16	16-bit unsigned integer
INT32_B	32-bit signed integer (big endian)
INT32_L	32-bit signed integer (little endian)
UINT32_B	32-bit unsigned integer (big endian)
UINT32_L	32-bit unsigned integer (little endian)
FLOAT_B	32-bit floating point (big endian)
FLOAT_L	32-bit floating point (little endian)
BIT	Bit

#### Special value output

When a register is read or when its content is exported through the Modbus function, the GX/GP may output the following special values.

Channel status	Data type	
	Integer	Floating
+Over, +Burnout	Maximum expressible value	$+\infty$
-Over, -Burnout	Minimum expressible value	$-\infty$

Example: Channel status is “-Over”

Data type	Output value
INT16	-32768 (0x8000)
INT32	-2147483648 (0x80000000)
FLOAT	$-\infty$ (0xff800000)

**Loading into Communication Channels**

- Read values from the server (slave) register into the communication channels of the GX/GP.
- The communication channel function is an option (/MC).

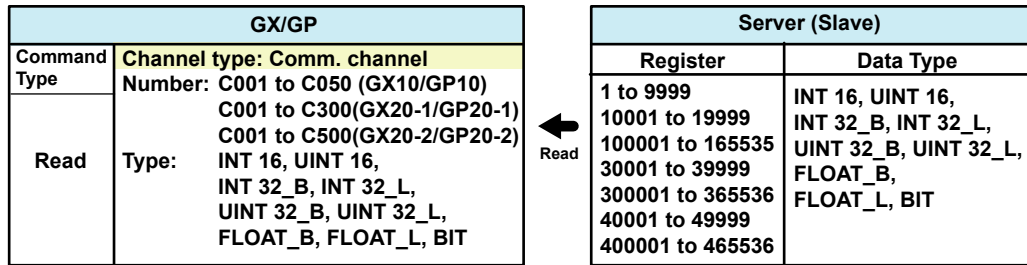

**Writing I/O Channel Data**

- Write I/O channel data to the server (slave) registers.

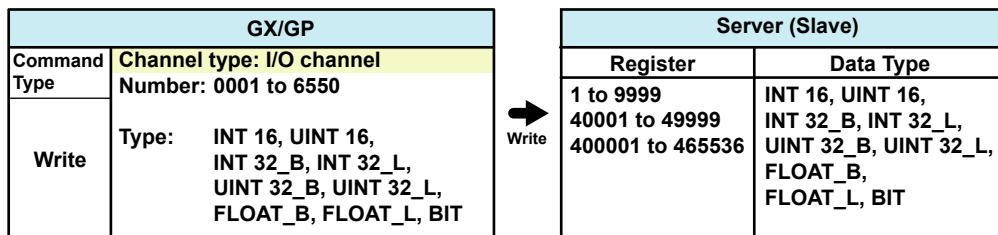

**Writing Math Channel Data**

- The math function is an option (/MT).
- Write math channel data to the server (slave) registers.

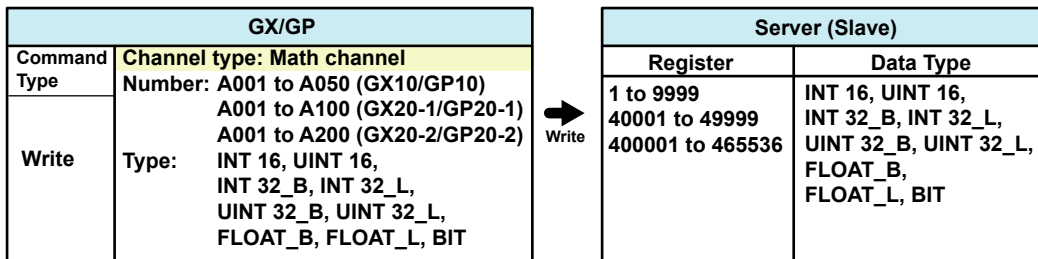

**Writing Communication Channel Data**

- Write GX/GP communication channel data to the server (slave) registers.

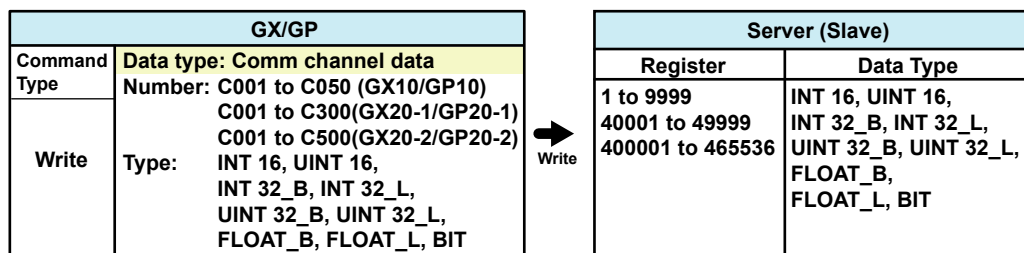

## 4.5.2 Modbus Server/Slave Function

### Function

The GX/GP supports the following functions.

Function Code	Function	Operation
1	Read the coil status (0xxxx)	The client (master) device reads the coil status of the GX/GP.
2	Read the input relay status (1xxxx, 1xxxxx)	The client (master) device reads the input relay status of the GX/GP.
3	Read the hold register (4XXXX, 4XXXXX)	The client (master) device reads the GX/GP data.
4	Read the input register (3XXXX, 3XXXXX)	The client (master) device reads the I/O, math, alarm, time data from the GX/GP.
5	Change the single coil status (0xxxx)	The client (master) device changes the single coil status (off/on) of the GX/GP.
6	Write to a single hold register (4xxxx, 4xxxxx)	The client (master) device writes to a single hold register of the GX/GP.
8 <sup>1</sup>	Loop-back test	The master device performs a GX/GP loopback test.
15	Change the coil status (0xxxx)	The client (master) device changes the coil status (off/on) of the GX/GP.
16	Write to the hold register (4XXXX, 4XXXXX)	The client (master) device writes to the GX/GP communication channels.

<sup>1</sup> Loopback test is only for serial communication.

## 4.5.3 Register Assignments (Shared with the Modbus server/slave function)

### Input Register

Unit	Type		GX/GP Register	
			Number	Data Type
GX/GP main unit	I/O channel	I/O data	300001 to 301000	32-bit signed integer
			301001 to 302000	32-bit floating point
		302001 to 302500	16-bit signed integer	
		Status information	302501 to 303000	16-bit signed integer
	I/O channel (continuous area)	I/O data	304001 to 304200	32-bit signed integer
			304201 to 304400	32-bit floating point
		304401 to 304500	16-bit signed integer	
		Status information	304501 to 304600	16-bit signed integer
	Math channel (A001 to 100)	Math data	305001 to 305200	32-bit signed integer
			305201 to 305400	32-bit floating point
		305401 to 305500	16-bit signed integer	
		Status information	305501 to 305600	16-bit signed integer
	Math channel (A101 to 200)	Math data	306001 to 306200	32-bit signed integer
			306201 to 306400	32-bit floating point
306401 to 306500		16-bit signed integer		
Status information		306501 to 306600	16-bit signed integer	
	GX/GP status		308001 to 308007	16-bit signed integer
Expandable I/O	Unit 1 I/O channel	I/O data	310001 to 311000	32-bit signed integer
			311001 to 312000	32-bit floating point
		312001 to 312500	16-bit signed integer	
		Status information	312501 to 313000	16-bit signed integer
	Unit 2 I/O channel	I/O data	315001 to 316000	32-bit signed integer
			316001 to 317000	32-bit floating point
		317001 to 317500	16-bit signed integer	
		Status information	317501 to 318000	16-bit signed integer
	Unit 3 I/O channel	I/O data	320001 to 321000	32-bit signed integer
			321001 to 322000	32-bit floating point
		322001 to 322500	16-bit signed integer	
		Status information	322501 to 323500	16-bit signed integer
	Unit 4 I/O channel	I/O data	325001 to 326000	32-bit signed integer
			326001 to 327000	32-bit floating point
		327001 to 327500	16-bit signed integer	
		Status information	327501 to 328000	16-bit signed integer

Continued on next page

4.5 Modbus Function and Register Assignments

Unit	Type		GX/GP Register	
			Number	Data Type
Expandable I/O	Unit 5 I/O channel	I/O data	330001 to 331000	32-bit signed integer
			331001 to 332000	32-bit floating point
			332001 to 332500	16-bit signed integer
	Unit 6 I/O channel	I/O data	332501 to 333000	16-bit signed integer
			335001 to 336000	32-bit signed integer
			336001 to 337000	32-bit floating point
Status information	337001 to 337500	16-bit signed integer		
	337501 to 338000	16-bit signed integer		



**Hold Register**

Unit	Type		GX/GP Register		
			Number	Data Type	
GX/GP main unit	I/O channel	I/O data	400001 to 401000	32-bit signed integer	
			401001 to 402000	32-bit floating point	
		402001 to 402500	16-bit signed integer		
		Status information	402501 to 403000	16-bit signed integer	
	I/O channel (continuous area)	I/O data	404001 to 404200	32-bit signed integer	
			404201 to 404400	32-bit floating point	
			404401 to 404500	16-bit signed integer	
	Communication channel	Communication data	404501 to 404600	16-bit signed integer	
			405001 to 406000	32-bit signed integer	
	Internal switch GX/GP operation setting	Status information	406001 to 407000	32-bit floating point	
407001 to 407500			16-bit signed integer		
Expandable I/O	Unit 1 I/O channel	I/O data	407501 to 408000	16-bit signed integer	
			408001 to 408100	16-bit signed integer	
	Unit 2 I/O channel	I/O data	409001 to 410000	16-bit signed integer	
			410001 to 411000	32-bit signed integer	
	Unit 3 I/O channel	I/O data	411001 to 412000	32-bit floating point	
			412001 to 412500	16-bit signed integer	
	Unit 4 I/O channel	I/O data	Status information	412501 to 413000	16-bit signed integer
			415001 to 416000	32-bit signed integer	
	Unit 5 I/O channel	I/O data	416001 to 417000	32-bit floating point	
			417001 to 417500	16-bit signed integer	
	Unit 6 I/O channel	I/O data	Status information	417501 to 418000	16-bit signed integer
			420001 to 421000	32-bit signed integer	
	Channel properties	Channel information	Channel properties	421001 to 422000	32-bit floating point
				422001 to 422500	16-bit signed integer
	Unit 1 I/O channel	I/O data	Status information	422501 to 423000	16-bit signed integer
			425001 to 426000	32-bit signed integer	
	Unit 2 I/O channel	I/O data	426001 to 427000	32-bit floating point	
			427001 to 427500	16-bit signed integer	
	Unit 3 I/O channel	I/O data	Status information	427501 to 428000	16-bit signed integer
			430001 to 431000	32-bit signed integer	
Unit 4 I/O channel	I/O data	431001 to 432000	32-bit floating point		
		432001 to 432500	16-bit signed integer		
Unit 5 I/O channel	I/O data	Status information	432501 to 433000	16-bit signed integer	
		435001 to 436000	32-bit signed integer		
Unit 6 I/O channel	I/O data	436001 to 437000	32-bit floating point		
		437001 to 437500	16-bit signed integer		
Channel properties	Channel information	Channel properties	437501 to 438000	16-bit signed integer	
			440001 to 465000	16-bit signed integer	



**Coil**

Type		GX/GP Register	
		Number	Data Type
I/O channel	I/O data	00001 to 00500	Bit string
	Status information	00501 to 01000	
Communication channel	Communication data	01001 to 01500	
	Status information	01501 to 02000	
Internal switch		02001 to 02100	



**Input Relay**

Type		GX/GP Register	
		Number	Data Type
I/O channel	I/O data	100001 to 100500	Bit string
	Status information	100501 to 101000	
Math channel	Math data	101001 to 101200	
	Status information	101501 to 101700	



### 4.5.4 Input Registers (Shared with the Modbus server/slave function)

**Common Items**

- The client device can only read the input registers.
- Decimal place and unit are not included. Specify them on the client device.
- Due to the different number of channels between modules, unavailable channel numbers will exist. This will not cause a register read error, so you can read the data continuously.
- The register values for unavailable channel numbers are set to 0, and the status information is set to SKIP.
- Channel range by model

Channel type	GX20/GP20	GX20-2/GP20-2	GX10/GP10
I/O channel	0001 to 6950	0001 to 6950	0001 to 6950
Math channel	A001 to A100	A001 to A200	A001 to A050

- If Log scale calculation (/LG option) is performed on an AI channel, data of I/O channels set to 32-bit signed integer or 16-bit signed integer will be an integer with two- or three-digit mantissa.

**I/O Channel Data**

- **32-bit Signed Integer**

Unit	I/O Channel Data	Input Register	Data Type
GX/GP main unit	Lower bytes of the channel 0001 data	300001	32-bit signed integer
	Higher bytes of the channel 0001 data	300002	
	Lower bytes of the channel 0050 data	300099	
	Higher bytes of the channel 0050 data	300100	
	Lower bytes of the channel 0101 data	300101	
	Higher bytes of the channel 0101 data	300102	
	Lower bytes of the channel 0150 data	300199	
	Higher bytes of the channel 0150 data	300200	
	Lower bytes of the channel 0201 data	300201	
	Higher bytes of the channel 0201 data	300202	
	Lower bytes of the channel 0250 data	300299	
	Higher bytes of the channel 0250 data	300300	
	Lower bytes of the channel 0301 data	300301	
	Higher bytes of the channel 0301 data	300302	
	Lower bytes of the channel 0350 data	300399	
	Higher bytes of the channel 0350 data	300400	
	Lower bytes of the channel 0401 data	300401	
	Higher bytes of the channel 0401 data	300402	
	Lower bytes of the channel 0450 data	300499	
	Higher bytes of the channel 0450 data	300500	
	Lower bytes of the channel 0501 data	300501	
	Higher bytes of the channel 0501 data	300502	
	Lower bytes of the channel 0550 data	300599	
	Higher bytes of the channel 0550 data	300600	
	Lower bytes of the channel 0601 data	300601	
	Higher bytes of the channel 0601 data	300602	
	Lower bytes of the channel 0650 data	300699	
	Higher bytes of the channel 0650 data	300700	
	Lower bytes of the channel 0701 data	300701	
	Higher bytes of the channel 0701 data	300702	
	Lower bytes of the channel 0750 data	300799	
	Higher bytes of the channel 0750 data	300800	
Lower bytes of the channel 0801 data	300801		
Higher bytes of the channel 0801 data	300802		
Lower bytes of the channel 0850 data	300899		

Continued on next page

Unit	I/O Channel Data	Input Register	Data Type
GX/GP main unit	Higher bytes of the channel 0850 data	300900	32-bit signed integer
	Lower bytes of the channel 0901 data	300901	
	Higher bytes of the channel 0901 data	300902	
	Lower bytes of the channel 0950 data	300999	
Expandable I/O 1	Higher bytes of the channel 0950 data	301000	
	Lower bytes of the channel 1001 data	310001	
Expandable I/O 1	Higher bytes of the channel 1001 data	310002	
Expandable I/O 1	Lower bytes of the channel 1050 data	310099	
	Higher bytes of the channel 1050 data	310100	
Expandable I/O 1	Lower bytes of the channel 1101 data	310101	
	Higher bytes of the channel 1101 data	310102	
Expandable I/O 1			
	Lower bytes of the channel 1150 data	310199	
Expandable I/O 1	Higher bytes of the channel 1150 data	310200	
	Lower bytes of the channel 1201 data	310201	
Expandable I/O 1	Higher bytes of the channel 1201 data	310202	
Expandable I/O 1	Lower bytes of the channel 1250 data	310299	
	Higher bytes of the channel 1250 data	310300	
Expandable I/O 1	Lower bytes of the channel 1301 data	310301	
	Higher bytes of the channel 1301 data	310302	
Expandable I/O 1			
	Lower bytes of the channel 1350 data	310399	
Expandable I/O 1	Higher bytes of the channel 1350 data	310400	
	Lower bytes of the channel 1401 data	310401	
Expandable I/O 1	Higher bytes of the channel 1401 data	310402	
Expandable I/O 1	Lower bytes of the channel 1450 data	310499	
	Higher bytes of the channel 1450 data	310500	
Expandable I/O 1	Lower bytes of the channel 1501 data	310501	
	Higher bytes of the channel 1501 data	310502	
Expandable I/O 1			
	Lower bytes of the channel 1550 data	310599	
Expandable I/O 1	Higher bytes of the channel 1550 data	310600	
	Expandable I/O 2	Lower bytes of the channel 2001 data	315001
Higher bytes of the channel 2001 data		315002	
Expandable I/O 2			
	Lower bytes of the channel 2050 data	315099	
Expandable I/O 2	Higher bytes of the channel 2050 data	315100	
	Lower bytes of the channel 2101 data	315101	
Expandable I/O 2	Higher bytes of the channel 2101 data	315102	
Expandable I/O 2	Lower bytes of the channel 2150 data	315199	
	Higher bytes of the channel 2150 data	315200	
Expandable I/O 2	Lower bytes of the channel 2201 data	315201	
	Higher bytes of the channel 2201 data	315202	
Expandable I/O 2			
	Lower bytes of the channel 2250 data	315299	
Expandable I/O 2	Higher bytes of the channel 2250 data	315300	
	Lower bytes of the channel 2301 data	315301	
Expandable I/O 2	Higher bytes of the channel 2301 data	315302	
Expandable I/O 2	Lower bytes of the channel 2350 data	315399	
	Higher bytes of the channel 2350 data	315400	
Expandable I/O 2	Lower bytes of the channel 2401 data	315401	
	Higher bytes of the channel 2401 data	315402	
Expandable I/O 2			
	Lower bytes of the channel 2450 data	315499	
Expandable I/O 2	Higher bytes of the channel 2450 data	315500	
	Lower bytes of the channel 2501 data	315501	
Expandable I/O 2	Higher bytes of the channel 2501 data	315502	
Expandable I/O 2	Lower bytes of the channel 2550 data	315599	
	Higher bytes of the channel 2550 data	315600	

Continued on next page

#### 4.5 Modbus Function and Register Assignments

Unit	I/O Channel Data	Input Register	Data Type
Expandable I/O 3	Lower bytes of the channel 3001 data	320001	32-bit floating point
	Higher bytes of the channel 3001 data	320002	
	Lower bytes of the channel 3050 data	320099	
	Higher bytes of the channel 3050 data	320100	
	Lower bytes of the channel 3101 data	320101	
	Higher bytes of the channel 3101 data	320102	
	Lower bytes of the channel 3150 data	320199	
	Higher bytes of the channel 3150 data	320200	
	Lower bytes of the channel 3201 data	320201	
	Higher bytes of the channel 3201 data	320202	
	Lower bytes of the channel 3250 data	320299	
	Higher bytes of the channel 3250 data	320300	
	Lower bytes of the channel 3301 data	320301	
	Higher bytes of the channel 3301 data	320302	
	Lower bytes of the channel 3350 data	320399	
	Higher bytes of the channel 3350 data	320400	
	Lower bytes of the channel 3401 data	320401	
	Higher bytes of the channel 3401 data	320402	
	Lower bytes of the channel 3450 data	320499	
	Higher bytes of the channel 3450 data	320500	
	Lower bytes of the channel 3501 data	320501	
	Higher bytes of the channel 3501 data	320502	
	Lower bytes of the channel 3550 data	320599	
	Higher bytes of the channel 3550 data	320600	
Expandable I/O 4	Lower bytes of the channel 4001 data	325001	
	Higher bytes of the channel 4001 data	325002	
	Lower bytes of the channel 4050 data	325099	
	Higher bytes of the channel 4050 data	325100	
	Lower bytes of the channel 4101 data	325101	
	Higher bytes of the channel 4101 data	325102	
	Lower bytes of the channel 4150 data	325199	
	Higher bytes of the channel 4150 data	325200	
	Lower bytes of the channel 4201 data	325201	
	Higher bytes of the channel 4201 data	325202	
	Lower bytes of the channel 4250 data	325299	
	Higher bytes of the channel 4250 data	325300	
	Lower bytes of the channel 4301 data	325301	
	Higher bytes of the channel 4301 data	325302	
	Lower bytes of the channel 4350 data	325399	
	Higher bytes of the channel 4350 data	325400	
	Lower bytes of the channel 4401 data	325401	
	Higher bytes of the channel 4401 data	325402	
	Lower bytes of the channel 4450 data	325499	
	Higher bytes of the channel 4450 data	325500	
	Lower bytes of the channel 4501 data	325201	
	Higher bytes of the channel 4501 data	325502	
	Lower bytes of the channel 4550 data	325599	
	Higher bytes of the channel 4550 data	325600	

Continued on next page



Unit	I/O Channel Data	Input Register	Data Type	
Expandable I/O 5	Lower bytes of the channel 5001 data	330001	32-bit floating point	
	Higher bytes of the channel 5001 data	330002		
	Lower bytes of the channel 5050 data	330099		
	Higher bytes of the channel 5050 data	330100		
	Lower bytes of the channel 5101 data	330101		
	Higher bytes of the channel 5101 data	330102		
	Lower bytes of the channel 5150 data	330199		
	Higher bytes of the channel 5150 data	330200		
	Lower bytes of the channel 5201 data	330201		
	Higher bytes of the channel 5201 data	330202		
	Lower bytes of the channel 5250 data	330299		
	Higher bytes of the channel 5250 data	330300		
	Lower bytes of the channel 5301 data	330301		
	Higher bytes of the channel 5301 data	330302		
	Lower bytes of the channel 5350 data	330399		
	Higher bytes of the channel 5350 data	330400		
	Lower bytes of the channel 5401 data	330401		
	Higher bytes of the channel 5401 data	330402		
	Lower bytes of the channel 5450 data	330499		
	Higher bytes of the channel 5450 data	330500		
	Lower bytes of the channel 5501 data	330501		
	Higher bytes of the channel 5501 data	330502		
	Lower bytes of the channel 5550 data	330599		
	Higher bytes of the channel 5550 data	330600		
	Expandable I/O 6	Lower bytes of the channel 6001 data	335001	
		Higher bytes of the channel 6001 data	335002	
Lower bytes of the channel 6050 data		335099		
Higher bytes of the channel 6050 data		335100		
Lower bytes of the channel 6101 data		335101		
Higher bytes of the channel 6101 data		335102		
Lower bytes of the channel 6150 data		335199		
Higher bytes of the channel 6150 data		335200		
Lower bytes of the channel 6201 data		335201		
Higher bytes of the channel 6201 data		335202		
Lower bytes of the channel 6250 data		335299		
Higher bytes of the channel 6250 data		335300		
Lower bytes of the channel 6301 data		335301		
Higher bytes of the channel 6301 data		335302		
Lower bytes of the channel 6350 data		335399		
Higher bytes of the channel 6350 data		335400		
Lower bytes of the channel 6401 data		335401		
Higher bytes of the channel 6401 data		335402		
Lower bytes of the channel 6450 data		335499		
Higher bytes of the channel 6450 data		335500		
Lower bytes of the channel 6501 data		335501		
Higher bytes of the channel 6501 data		335502		
Lower bytes of the channel 6550 data		335599		
Higher bytes of the channel 6550 data		335600		

Continued on next page

#### 4.5 Modbus Function and Register Assignments

Unit	I/O Channel Data	Input Register	Data Type
	• Register		
	<b>Channel 0001 example</b>		
	• There is no decimal place information.		

#### • 32-bit floating point

Unit	I/O Channel Data	Input Register	Data Type
GX/GP main unit	Lower bytes of the channel 0001 data	301001	32-bit floating point
	Higher bytes of the channel 0001 data	301002	
	Lower bytes of the channel 0050 data	301099	
	Higher bytes of the channel 0050 data	301100	
	Lower bytes of the channel 0101 data	301101	
	Higher bytes of the channel 0101 data	301102	
	Lower bytes of the channel 0150 data	301199	
	Higher bytes of the channel 0150 data	301200	
	Lower bytes of the channel 0201 data	301201	
	Higher bytes of the channel 0201 data	301202	
	Lower bytes of the channel 0250 data	301299	
	Higher bytes of the channel 0250 data	301300	
	Lower bytes of the channel 0301 data	301301	
	Higher bytes of the channel 0301 data	301302	
	Lower bytes of the channel 0350 data	301399	
	Higher bytes of the channel 0350 data	301400	
	Lower bytes of the channel 0401 data	301401	
	Higher bytes of the channel 0401 data	301402	
	Lower bytes of the channel 0450 data	301499	
	Higher bytes of the channel 0450 data	301500	
	Lower bytes of the channel 0501 data	301501	
	Higher bytes of the channel 0501 data	301502	
	Lower bytes of the channel 0550 data	301599	
	Higher bytes of the channel 0550 data	301600	
	Lower bytes of the channel 0601 data	301601	
	Higher bytes of the channel 0601 data	301602	
	Lower bytes of the channel 0650 data	301699	
	Higher bytes of the channel 0650 data	301700	
	Lower bytes of the channel 0701 data	301701	
	Higher bytes of the channel 0701 data	301702	
	Lower bytes of the channel 0750 data	301799	
	Higher bytes of the channel 0750 data	301800	
Lower bytes of the channel 0801 data	301801		
Higher bytes of the channel 0801 data	301802		
Lower bytes of the channel 0850 data	301899		
Higher bytes of the channel 0850 data	301900		
Lower bytes of the channel 0901 data	301901		
Higher bytes of the channel 0901 data	301902		
Lower bytes of the channel 0950 data	301999		
Higher bytes of the channel 0950 data	302000		

Continued on next page

Unit	I/O Channel Data	Input Register	Data Type
Expandable I/O 1	Lower bytes of the channel 1001 data	311001	32-bit floating point
	Higher bytes of the channel 1001 data	311002	
	Lower bytes of the channel 1050 data	311099	
	Higher bytes of the channel 1050 data	311100	
	Lower bytes of the channel 1101 data	311101	
	Higher bytes of the channel 1101 data	311102	
	Lower bytes of the channel 1150 data	311199	
	Higher bytes of the channel 1150 data	311200	
	Lower bytes of the channel 1201 data	311201	
	Higher bytes of the channel 1201 data	311202	
	Lower bytes of the channel 1250 data	311299	
	Higher bytes of the channel 1250 data	311300	
	Lower bytes of the channel 1301 data	311301	
	Higher bytes of the channel 1301 data	311302	
	Lower bytes of the channel 1350 data	311399	
	Higher bytes of the channel 1350 data	311400	
	Lower bytes of the channel 1401 data	311401	
	Higher bytes of the channel 1401 data	311402	
	Lower bytes of the channel 1450 data	311499	
	Higher bytes of the channel 1450 data	311500	
Lower bytes of the channel 1501 data	311501		
Higher bytes of the channel 1501 data	311502		
Lower bytes of the channel 1550 data	311599		
Higher bytes of the channel 1550 data	311600		
Expandable I/O 2	Lower bytes of the channel 2001 data	316001	
	Higher bytes of the channel 2001 data	316002	
	Lower bytes of the channel 2050 data	316099	
	Higher bytes of the channel 2050 data	316100	
	Lower bytes of the channel 2101 data	316101	
	Higher bytes of the channel 2101 data	316102	
	Lower bytes of the channel 2150 data	316199	
	Higher bytes of the channel 2150 data	316200	
	Lower bytes of the channel 2201 data	316201	
	Higher bytes of the channel 2201 data	316202	
	Lower bytes of the channel 2250 data	316299	
	Higher bytes of the channel 2250 data	316300	
	Lower bytes of the channel 2301 data	316301	
	Higher bytes of the channel 2301 data	316302	
	Lower bytes of the channel 2350 data	316399	
	Higher bytes of the channel 2350 data	316400	
	Lower bytes of the channel 2401 data	316401	
	Higher bytes of the channel 2401 data	316402	
	Lower bytes of the channel 2450 data	316499	
	Higher bytes of the channel 2450 data	316500	
Lower bytes of the channel 2501 data	316501		
Higher bytes of the channel 2501 data	316502		
Lower bytes of the channel 2550 data	316599		
Higher bytes of the channel 2550 data	316600		

Continued on next page

#### 4.5 Modbus Function and Register Assignments

Unit	I/O Channel Data	Input Register	Data Type
Expandable I/O 3	Lower bytes of the channel 3001 data	321001	32-bit floating point
	Higher bytes of the channel 3001 data	321002	
	Lower bytes of the channel 3050 data	321099	
	Higher bytes of the channel 3050 data	321100	
	Lower bytes of the channel 3101 data	321101	
	Higher bytes of the channel 3101 data	321102	
	Lower bytes of the channel 3150 data	321199	
	Higher bytes of the channel 3150 data	321200	
	Lower bytes of the channel 3201 data	321201	
	Higher bytes of the channel 3201 data	321202	
	Lower bytes of the channel 3250 data	321299	
	Higher bytes of the channel 3250 data	321300	
	Lower bytes of the channel 3301 data	321301	
	Higher bytes of the channel 3301 data	321302	
	Lower bytes of the channel 3350 data	321399	
	Higher bytes of the channel 3350 data	321400	
	Lower bytes of the channel 3401 data	321401	
	Higher bytes of the channel 3401 data	321402	
	Lower bytes of the channel 3450 data	321499	
	Higher bytes of the channel 3450 data	321500	
	Lower bytes of the channel 3501 data	321501	
	Higher bytes of the channel 3501 data	321502	
	Lower bytes of the channel 3550 data	321599	
	Higher bytes of the channel 3550 data	321600	
Expandable I/O 4	Lower bytes of the channel 4001 data	326001	
	Higher bytes of the channel 4001 data	326002	
	Lower bytes of the channel 4050 data	326099	
	Higher bytes of the channel 4050 data	326100	
	Lower bytes of the channel 4101 data	326101	
	Higher bytes of the channel 4101 data	326102	
	Lower bytes of the channel 4150 data	326199	
	Higher bytes of the channel 4150 data	326200	
	Lower bytes of the channel 4201 data	326201	
	Higher bytes of the channel 4201 data	326202	
	Lower bytes of the channel 4250 data	326299	
	Higher bytes of the channel 4250 data	326300	
	Lower bytes of the channel 4301 data	326301	
	Higher bytes of the channel 4301 data	326302	
	Lower bytes of the channel 4350 data	326399	
	Higher bytes of the channel 4350 data	326400	
	Lower bytes of the channel 4401 data	326401	
	Higher bytes of the channel 4401 data	326402	
	Lower bytes of the channel 4450 data	326499	
	Higher bytes of the channel 4450 data	326500	
	Lower bytes of the channel 4501 data	326501	
	Higher bytes of the channel 4501 data	326502	
	Lower bytes of the channel 4550 data	326599	
	Higher bytes of the channel 4550 data	326600	

Continued on next page

Unit	I/O Channel Data	Input Register	Data Type
Expandable I/O 5	Lower bytes of the channel 5001 data	331001	32-bit floating point
	Higher bytes of the channel 5001 data	331002	
	Lower bytes of the channel 5050 data	331099	
	Higher bytes of the channel 5050 data	331100	
	Lower bytes of the channel 5101 data	331101	
	Higher bytes of the channel 5101 data	331102	
	Lower bytes of the channel 5150 data	331199	
	Higher bytes of the channel 5150 data	331200	
	Lower bytes of the channel 5201 data	331201	
	Higher bytes of the channel 5201 data	331202	
	Lower bytes of the channel 5250 data	331299	
	Higher bytes of the channel 5250 data	331300	
	Lower bytes of the channel 5301 data	331301	
	Higher bytes of the channel 5301 data	331302	
	Lower bytes of the channel 5350 data	331399	
	Higher bytes of the channel 5350 data	331400	
	Lower bytes of the channel 5401 data	331401	
	Higher bytes of the channel 5401 data	331402	
	Lower bytes of the channel 5450 data	331499	
	Higher bytes of the channel 5450 data	331500	
Lower bytes of the channel 5501 data	331501		
Higher bytes of the channel 5501 data	331502		
Lower bytes of the channel 5550 data	331599		
Higher bytes of the channel 5550 data	331600		
Expandable I/O 6	Lower bytes of the channel 6001 data	336001	
	Higher bytes of the channel 6001 data	336002	
	Lower bytes of the channel 6050 data	336099	
	Higher bytes of the channel 6050 data	336100	
	Lower bytes of the channel 6101 data	336101	
	Higher bytes of the channel 6101 data	336102	
	Lower bytes of the channel 6150 data	336199	
	Higher bytes of the channel 6150 data	336200	
	Lower bytes of the channel 6201 data	336201	
	Higher bytes of the channel 6201 data	336202	
	Lower bytes of the channel 6250 data	336299	
	Higher bytes of the channel 6250 data	336300	
	Lower bytes of the channel 6301 data	336301	
	Higher bytes of the channel 6301 data	336302	
	Lower bytes of the channel 6350 data	336399	
	Higher bytes of the channel 6350 data	336400	
	Lower bytes of the channel 6401 data	336401	
	Higher bytes of the channel 6401 data	336402	
	Lower bytes of the channel 6450 data	336499	
	Higher bytes of the channel 6450 data	336500	
Lower bytes of the channel 6501 data	336501		
Higher bytes of the channel 6501 data	336502		
Lower bytes of the channel 6550 data	336599		
Higher bytes of the channel 6550 data	336600		

• **16-bit Signed Integer**

Unit	I/O Channel Data	Input Register	Data Type
GX/GP main unit	Channel 0001 data	302001	16-bit signed integer
	Channel 0050 data	302050	
	Channel 0101 data	302051	
	Channel 0150 data	302100	
	Channel 0201 data	302101	
	Channel 0250 data	302150	
	Channel 0301 data	302151	
	Channel 0350 data	302200	
	Channel 0401 data	302201	
	Channel 0450 data	302250	
	Channel 0501 data	302251	
	Channel 0550 data	302300	
	Channel 0601 data	302301	
	Channel 0650 data	302350	
	Channel 0701 data	302351	
	Channel 0750 data	302400	
	Channel 0801 data	302401	
	Channel 0850 data	302450	
	Channel 0901 data	302451	
	Channel 0950 data	302500	
Expandable I/O 1	Channel 1001 data	312001	
	Channel 1050 data	312050	
	Channel 1101 data	312051	
	Channel 1150 data	312100	
	Channel 1201 data	312101	
	Channel 1250 data	312150	
	Channel 1301 data	312151	
	Channel 1350 data	312200	
	Channel 1401 data	312201	
	Channel 1450 data	312250	
Channel 1501 data	312251		
Expandable I/O 2	Channel 1550 data	312300	
	Channel 2001 data	317001	
	Channel 2050 data	317050	
	Channel 2101 data	317051	
	Channel 2150 data	317100	
	Channel 2201 data	317101	
	Channel 2250 data	317150	
	Channel 2301 data	317151	
	Channel 2350 data	317200	
	Channel 2401 data	317201	
Channel 2450 data	317250		

Continued on next page

Unit	I/O Channel Data	Input Register	Data Type
Expandable I/O 2	Channel 2501 data	317251	16-bit signed integer
	Channel 2550 data	317300	
Expandable I/O 3	Channel 3001 data	322001	
	Channel 3050 data	322050	
	Channel 3101 data	322051	
	Channel 3150 data	322100	
	Channel 3201 data	322101	
	Channel 3250 data	322150	
	Channel 3301 data	322151	
	Channel 3350 data	322200	
	Channel 3401 data	322201	
	Channel 3450 data	322250	
	Channel 3501 data	322251	
	Channel 3550 data	322300	
	Expandable I/O 4	Channel 4001 data	327001
		Channel 4050 data	327050
Channel 4101 data		327051	
Channel 4150 data		327100	
Channel 4201 data		327101	
Channel 4250 data		327150	
Channel 4301 data		327151	
Channel 4350 data		327200	
Channel 4401 data		327201	
Channel 4450 data		327250	
Channel 4501 data		327251	
Channel 4550 data		327300	
Expandable I/O 5		Channel 5001 data	332001
		Channel 5050 data	332050
	Channel 5101 data	332051	
	Channel 5150 data	332100	
	Channel 5201 data	332101	
	Channel 5250 data	332150	
	Channel 5301 data	332151	
	Channel 5350 data	332200	
	Channel 5401 data	332201	
	Channel 5450 data	332250	
	Channel 5501 data	332251	
	Channel 5550 data	332300	

Continued on next page

#### 4.5 Modbus Function and Register Assignments

Unit	I/O Channel Data	Input Register	Data Type
Expandable I/O 6	Channel 6001 data	337001	16-bit signed integer
	Channel 6050 data	337050	
	Channel 6101 data	337051	
	Channel 6150 data	337100	
	Channel 6201 data	337101	
	Channel 6250 data	337150	
	Channel 6301 data	337151	
	Channel 6350 data	337200	
	Channel 6401 data	337201	
	Channel 6450 data	337250	
	Channel 6501 data	337251	
	Channel 6550 data	337300	

#### I/O Channel Data Status Information

Unit	I/O Channel Data	Input Register	Data Type
GX/GP main unit	Channel 0001 status information	302501	16-bit signed integer
	Channel 0050 status information	302550	
	Channel 0101 status information	302551	
	Channel 0150 status information	302600	
	Channel 0201 status information	302601	
	Channel 0250 status information	302650	
	Channel 0301 status information	302651	
	Channel 0350 status information	302700	
	Channel 0401 status information	302701	
	Channel 0450 status information	302750	
	Channel 0501 status information	302751	
	Channel 0550 status information	302800	
	Channel 0601 status information	302801	
	Channel 0650 status information	302850	
	Channel 0701 status information	302851	
	Channel 0750 status information	302900	
	Channel 0801 status information	302901	
	Channel 0850 status information	302950	
	Channel 0901 status information	302951	
	Channel 0950 status information	303000	
Expandable I/O 1	Channel 1001 status information	312501	
	Channel 1050 status information	312550	
	Channel 1101 status information	312551	
	Channel 1150 status information	312600	
	Channel 1201 status information	312601	
	Channel 1250 status information	312650	
	Channel 1301 status information	312651	
	Channel 1350 status information	312700	
Channel 1401 status information	312701		
Channel 1450 status information	312750		

Continued on next page



Unit	I/O Channel Data	Input Register	Data Type
Expandable I/O 1	Channel 1501 status information	312751	16-bit signed integer
	Channel 1550 status information	312800	
Expandable I/O 2	Channel 2001 status information	317501	
	Channel 2050 status information	317550	
	Channel 2101 status information	317551	
	Channel 2150 status information	317600	
	Channel 2201 status information	317601	
	Channel 2250 status information	317650	
	Channel 2301 status information	317651	
	Channel 2350 status information	317700	
	Channel 2401 status information	317701	
	Channel 2450 status information	317750	
	Channel 2501 status information	317751	
	Channel 2550 status information	317800	
	Expandable I/O 3	Channel 3001 status information	322501
		Channel 3050 status information	322550
		Channel 3101 status information	322551
Channel 3150 status information		322600	
Channel 3201 status information		322601	
Channel 3250 status information		322650	
Channel 3301 status information		322651	
Channel 3350 status information		322700	
Channel 3401 status information		322701	
Channel 3450 status information		322750	
Channel 3501 status information		322751	
Channel 3550 status information		322800	
Expandable I/O 4		Channel 4001 status information	327501
		Channel 4050 status information	327550
		Channel 4101 status information	327551
	Channel 4150 status information	327600	
	Channel 4201 status information	327601	
	Channel 4250 status information	327650	
	Channel 4301 status information	327651	
	Channel 4350 status information	327700	
	Channel 4401 status information	327701	
	Channel 4450 status information	327750	
	Channel 4501 status information	327751	
	Channel 4550 status information	327800	
	Expandable I/O 5	Channel 5001 status information	332501
		Channel 5050 status information	332550
		Channel 5101 status information	332551
Channel 5150 status information		332600	
Channel 5201 status information		332601	
Channel 5250 status information		332650	

Continued on next page

## 4.5 Modbus Function and Register Assignments

Unit	I/O Channel Data	Input Register	Data Type
Expandable I/O 5	Channel 5301 status information	332651	16-bit signed integer
	Channel 5350 status information	332700	
	Channel 5401 status information	332701	
	Channel 5450 status information	332750	
	Channel 5501 status information	332751	
	Channel 5550 status information	332800	
Expandable I/O 6	Channel 6001 status information	337501	
	Channel 6050 status information	337550	
	Channel 6101 status information	337551	
	Channel 6150 status information	337600	
	Channel 6201 status information	337601	
	Channel 6250 status information	337650	
	Channel 6301 status information	337651	
	Channel 6350 status information	337700	
	Channel 6401 status information	337701	
	Channel 6450 status information	337750	
	Channel 6501 status information	337751	
	Channel 6550 status information	337800	

- There is no decimal place information.

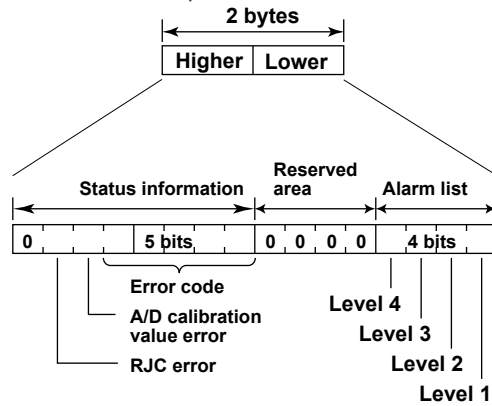

Error code	Meaning
0	No error
1	Skip
2	+Over
3	-Over
4	+Burnout
5	-Burnout
6	A/D error
7	Invalid data
16	Computation error
17	Communication error

**Register Configuration of PID Control Module Channels**

Register example of a PID control module installed in unit 0 (main unit) slot 0

\* If the PID modules is installed in unit 1 slot 3, the registers are allocated from channel number register 1301.

Channel Number	Description	Notes	
0001	PV of loop 1	PID computation data	
0002	SP of loop 1		
0003	OUT of loop 1		
0004	PV of loop 2		
0005	SP of loop 2		
0006	OUT of loop 2		
0007	Input 1 data	Physical channel data	
0008	Input 2 data		
0009	Output 1 data		
0010	Output 2 data		
0011	DI1 data		
0012	DI2 data		
0013	DI3 data		
0014	DI4 data		
0015	DI5 data		
0016	DI6 data		
0017	DI7 data		
0018	DI8 data		
0019	DO1 data		
0020	DO2 data		
0021	DO3 data		
0022	DO4 data		
0023	DO5 data		
0024	DO6 data		
0025	DO7 data		
0026	DO8 data		
0027	—		
0034	—		
0035	Alarms 1 to 4 of loop 1		The lower 8 bits are used.
0036	Alarms 1 to 4 of loop 2		The lower 8 bits are used.
0037	Auto/manual/cascade switching of loop 1		1: Auto 2: Manual 3: Cascade
0038	Auto/manual/cascade switching of loop 2		1: Auto 2: Manual 3: Cascade
0039	Run/stop switching of loop 1		1: Run 2: Stop
0040	Run/stop switching of loop 2		1: Run 2: Stop
0041	Remote/local switching of loop 1		1: Local 2: Remote
0042	Remote/local switching of loop 2		1: Local 2: Remote
0043	Target setpoint number (SP number) selection of loop 1	1 to 8	
0044	Target setpoint number (SP number) selection of loop 2	1 to 8	
0045	PID number selection of loop 1	Read Only	
0046	PID number selection of loop 2	Read Only	
0047	Auto-tuning status of loop 1	Read Only	
0048	Auto-tuning status of loop 2	Read Only	
0049	Alarm ACK of loop 1	1: Alarm ACK 0 when read	
0050	Alarm ACK of loop 2	1: Alarm ACK 0 when read	

**PID Control Module Status Information**

The following status information of each loop is output in unit of modules to channels 35 to 50.

Item	Description
Control alarm information	Alarms 1 to 4 lower 4 bits
Auto/manual/cascade status	1: Auto, 2: Manual, 3: Cascade
Run/stop status	1: Run, 2: Stop
Remote/local status	1: Local, 2: Remote
Target setpoint number (SP number) selection	1 to 8
PID number selection	1 to 8, 9 for the reference PID
Auto-tuning status	1 to 8 for when auto-tuning is in progress 9 for the reference PID
Alarm ACK	0 when stopped 0 when read

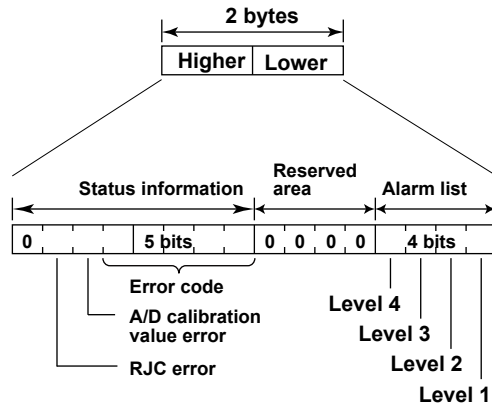

Error code	Meaning
0	No error
1	Skip
2	+Over
3	-Over
4	+Burnout
5	-Burnout
6	A/D error
7	Invalid data
16	Computation error
17	Communication error

**Math Channel Data and Status Information**

Data	Register	Data Type
Lower bytes of the computed data of channel A001	305001	32-bit signed integer
Higher bytes of the computed data of channel A001	305002	
Lower bytes of the computed data of channel A100	305199	32-bit signed integer
Higher bytes of the computed data of channel A100	305200	
Lower bytes of the computed data of channel A101	306001	32-bit signed integer
Higher bytes of the computed data of channel A101	306002	
Lower bytes of the computed data of channel A200	306199	32-bit signed integer
Higher bytes of the computed data of channel A200	306200	

• Register configuration of computed data

**Channel A001 example**

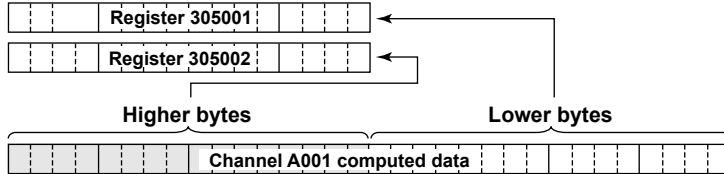

• There is no decimal place information.

Lower bytes of the computed data of channel A001	305201	32-bit floating point
Higher bytes of the computed data of channel A001	305202	
Lower bytes of the computed data of channel A100	305399	32-bit floating point
Higher bytes of the computed data of channel A100	305400	
Lower bytes of the computed data of channel A101	306201	32-bit floating point
Higher bytes of the computed data of channel A101	306202	
Lower bytes of the computed data of channel A200	306399	32-bit floating point
Higher bytes of the computed data of channel A200	306400	

• There is no decimal place information.

Channel A001 computed data	305401	16-bit signed integer
Channel A100 computed data	305500	
Channel A101 computed data	306401	
Channel A200 computed data	306500	

• There is no decimal place information.

Channel A001 status information	305501	16-bit signed integer
Channel A100 status information	305600	
Channel A101 status information	306501	
Channel A200 status information	306600	

• Status register configuration

This is the same as that of the I/O channel data status information.

**Continuous Channel Data Area**

The GX/GP reserves up to 50 channels of register area per module. For example, reading 100 channels of data from 10 analog input modules through normal input registers would be inefficient because there would be a lot of empty registers. The “continuous channel data area” is a special area that enables continuous reading by limiting the number of channels of each module to 10. It is for I/O channels installed in the GX/GP main unit.

**I/O Channel Data**

• **32-bit Signed Integer**

I/O Channel Data	Input Register	Data Type
Lower bytes of the channel 0001 data	304001	32-bit signed integer
Higher bytes of the channel 0001 data	304002	
Lower bytes of the channel 0010 data	304019	
Higher bytes of the channel 0010 data	304020	
Lower bytes of the channel 0101 data	304021	
Higher bytes of the channel 0101 data	304022	
Lower bytes of the channel 0110 data	304039	
Higher bytes of the channel 0110 data	304040	
Lower bytes of the channel 0201 data	304041	
Higher bytes of the channel 0201 data	304042	
Lower bytes of the channel 0210 data	304059	
Higher bytes of the channel 0210 data	304060	
Lower bytes of the channel 0301 data	304061	
Higher bytes of the channel 0301 data	304062	
Lower bytes of the channel 0310 data	304079	
Higher bytes of the channel 0310 data	304080	
Lower bytes of the channel 0401 data	304081	
Higher bytes of the channel 0401 data	304082	
Lower bytes of the channel 0410 data	304099	
Higher bytes of the channel 0410 data	304100	
Lower bytes of the channel 0501 data	304101	
Higher bytes of the channel 0501 data	304102	
Lower bytes of the channel 0510 data	304119	
Higher bytes of the channel 0510 data	304120	
Lower bytes of the channel 0601 data	304121	
Higher bytes of the channel 0601 data	304122	
Lower bytes of the channel 0610 data	304139	
Higher bytes of the channel 0610 data	304140	
Lower bytes of the channel 0701 data	304141	
Higher bytes of the channel 0701 data	304142	
Lower bytes of the channel 0710 data	304159	
Higher bytes of the channel 0710 data	304160	
Lower bytes of the channel 0801 data	304161	
Higher bytes of the channel 0801 data	304162	
Lower bytes of the channel 0810 data	304179	
Higher bytes of the channel 0810 data	304180	
Lower bytes of the channel 0901 data	304181	
Higher bytes of the channel 0901 data	304182	
Lower bytes of the channel 0910 data	304199	
Higher bytes of the channel 0910 data	304200	

Continued on next page

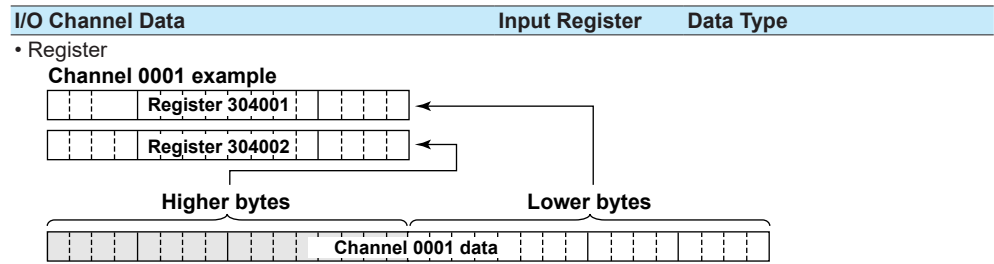

• There is no decimal place information.

• **32-bit floating point**

I/O Channel Data	Input Register	Data Type
Lower bytes of the channel 0001 data	304201	32-bit floating point
Higher bytes of the channel 0001 data	304202	
Lower bytes of the channel 0010 data	304219	
Higher bytes of the channel 0010 data	304220	
Lower bytes of the channel 0101 data	304221	
Higher bytes of the channel 0101 data	304222	
Lower bytes of the channel 0110 data	304239	
Higher bytes of the channel 0110 data	304240	
Lower bytes of the channel 0201 data	304241	
Higher bytes of the channel 0201 data	304242	
Lower bytes of the channel 0210 data	304259	
Higher bytes of the channel 0210 data	304260	
Lower bytes of the channel 0301 data	304261	
Higher bytes of the channel 0301 data	304262	
Lower bytes of the channel 0310 data	304279	
Higher bytes of the channel 0310 data	304280	
Lower bytes of the channel 0401 data	304281	
Higher bytes of the channel 0401 data	304282	
Lower bytes of the channel 0410 data	304299	
Higher bytes of the channel 0410 data	304300	
Lower bytes of the channel 0501 data	304301	
Higher bytes of the channel 0501 data	304302	
Lower bytes of the channel 0510 data	304319	
Higher bytes of the channel 0510 data	304320	
Lower bytes of the channel 0601 data	304321	
Higher bytes of the channel 0601 data	304322	
Lower bytes of the channel 0610 data	304339	
Higher bytes of the channel 0610 data	304340	
Lower bytes of the channel 0701 data	304341	
Higher bytes of the channel 0701 data	304342	
Lower bytes of the channel 0710 data	304359	
Higher bytes of the channel 0710 data	304360	
Lower bytes of the channel 0801 data	304361	
Higher bytes of the channel 0801 data	304362	
Lower bytes of the channel 0810 data	304379	
Higher bytes of the channel 0810 data	304380	
Lower bytes of the channel 0901 data	304381	
Higher bytes of the channel 0901 data	304382	
Lower bytes of the channel 0910 data	304399	
Higher bytes of the channel 0910 data	304400	

• **16-bit Signed Integer**

<b>I/O Channel Data</b>	<b>Input Register</b>	<b>Data Type</b>
Channel 0001 data	304401	16-bit signed integer
Channel 0010 data	304410	
Channel 0101 data	304411	
Channel 0110 data	304420	
Channel 0201 data	304421	
Channel 0210 data	304430	
Channel 0301 data	304431	
Channel 0310 data	304440	
Channel 0401 data	304441	
Channel 0410 data	304450	
Channel 0501 data	304451	
Channel 0510 data	304460	
Channel 0601 data	304461	
Channel 0610 data	304470	
Channel 0701 data	304471	
Channel 0710 data	304480	
Channel 0801 data	304481	
Channel 0810 data	304490	
Channel 0901 data	304491	
Channel 0910 data	304500	

**I/O Channel Data Status Information**

<b>I/O Channel Data</b>	<b>Input Register</b>	<b>Data Type</b>
Channel 0001 status information	304501	16-bit signed integer
Channel 0010 status information	304510	
Channel 0101 status information	304511	
Channel 0110 status information	304520	
Channel 0201 status information	304521	
Channel 0210 status information	304530	
Channel 0301 status information	304531	
Channel 0310 status information	304540	
Channel 0401 status information	304541	
Channel 0410 status information	304550	
Channel 0501 status information	304551	
Channel 0510 status information	304560	
Channel 0601 status information	304561	
Channel 0610 status information	304570	
Channel 0701 status information	304571	
Channel 0710 status information	304580	
Channel 0801 status information	304581	
Channel 0810 status information	304590	
Channel 0901 status information	304591	

Continued on next page



I/O Channel Data	Input Register	Data Type
Channel 0910 status information	304600	

• There is no decimal place information.

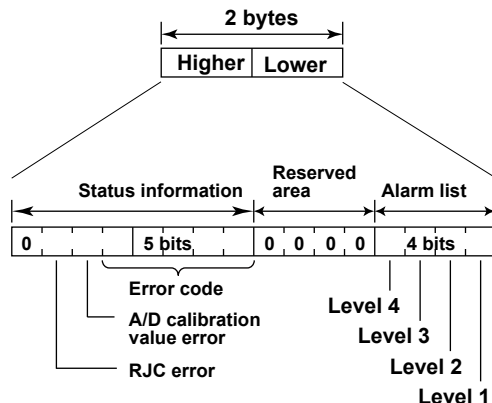

Error code	Meaning
0	No error
1	Skip
2	+Over
3	-Over
4	+Burnout
5	-Burnout
6	A/D error
7	Invalid data
16	Computation error
17	Communication error

### GX/GP Status

Data	Register	Description	Data Type
Measuring	308001	0: Recording stopped 1: Recording	16-bit signed integer
Computing	308002	0: Computing stopped 1: Computing	
Alarm activated	308003	0: No alarm 1: Alarm occurrence	
E-mail started	308004	0: No e-mail transmission 1: E-mail transmission available	
Memory end	308005	0: Space available in the internal memory or external storage 1: Not much space in the internal memory or external storage	
Screen login status	308006	0: No login 1: Logged in	
Modbus communication error	308007	0: Modbus master or client command normal 1: Modbus master or client command error	
User locked status (only for the advanced security function (IAS option))	308008	0: User unlocked status 1: User locked status	
Multi batch 1 measuring	308011	0: Recording stopped 1: Recording	
Multi batch 12 measuring	308022		

**Program Operation Status**

Data	Register	Description	Data Type
Program operation status	308101	1: Program operation stop, operation end 2: Program running	16-bit signed integer
Running pattern number display	308102	1 to 99	
Running segment number display	308103	1 to 99 0: Program stopped	
Wait state	308104	0: Not waiting 1: Waiting	
Remaining segment time of the running pattern (hours: 0 to 99)	308105	0 to 99 (hours)	
Remaining segment time of the running pattern (minutes: 0 to 59)	308106	0 to 59 (minutes)	
Remaining segment time of the running pattern (seconds: 0 to 59)	308107	0 to 59 (s)	
PV event status	308111   308142	0: Event absent 1: Event present	
Time event status	308151   308182	0: Event absent 1: Event present	

### 4.5.5 Hold Registers (Shared with the Modbus server/slave function)

#### Common Items

- The client device can read and write to the hold registers.
- Communication channels are an option (/MC).
- Channel range by model

Channel type	GX20-1/GP20-1	GX20-2/GP20-2	GX10/GP10
I/O channel	0001 to 6950	0001 to 6950	0001 to 6950
Communication channel	C001 to C300	C001 to C500	C001 to C050

- If Log scale calculation (/LG option) is performed on an AI channel, data of I/O channels set to 32-bit signed integer or 16-bit signed integer will be an integer with two- or three-digit mantissa.
- Math channel is input registers only.

#### I/O Channel Data<sup>1</sup>

- **32-bit Signed Integer**

Unit	I/O Channel Data	Hold Register	Data Type
GX/GP main unit	Lower bytes of the channel 0001 data	400001	32-bit signed integer
	Higher bytes of the channel 0001 data	400002	
	Lower bytes of the channel 0050 data	400099	
	Higher bytes of the channel 0050 data	400100	
	Lower bytes of the channel 0101 data	400101	
	Higher bytes of the channel 0101 data	400102	
	Lower bytes of the channel 0150 data	400199	
	Higher bytes of the channel 0150 data	400200	
	Lower bytes of the channel 0201 data	400201	
	Higher bytes of the channel 0201 data	400202	
	Lower bytes of the channel 0250 data	400299	
	Higher bytes of the channel 0250 data	400300	
	Lower bytes of the channel 0301 data	400301	
	Higher bytes of the channel 0301 data	400302	
	Lower bytes of the channel 0350 data	400399	
	Higher bytes of the channel 0350 data	400400	
	Lower bytes of the channel 0401 data	400401	
	Higher bytes of the channel 0401 data	400402	
	Lower bytes of the channel 0450 data	400499	
	Higher bytes of the channel 0450 data	400500	
	Lower bytes of the channel 0501 data	400501	
	Higher bytes of the channel 0501 data	400502	
	Lower bytes of the channel 0550 data	400599	
	Higher bytes of the channel 0550 data	400600	
	Lower bytes of the channel 0601 data	400601	
	Higher bytes of the channel 0601 data	400602	
	Lower bytes of the channel 0650 data	400699	
	Higher bytes of the channel 0650 data	400700	
	Lower bytes of the channel 0701 data	400701	
	Higher bytes of the channel 0701 data	400702	
	Lower bytes of the channel 0750 data	400799	
	Higher bytes of the channel 0750 data	400800	
Lower bytes of the channel 0801 data	400801		
Higher bytes of the channel 0801 data	400802		
Lower bytes of the channel 0850 data	400899		
Higher bytes of the channel 0850 data	400900		

Continued on next page

#### 4.5 Modbus Function and Register Assignments

Unit	I/O Channel Data	Hold Register	Data Type
GX/GP main unit	Lower bytes of the channel 0901 data	400901	32-bit signed integer
	Higher bytes of the channel 0901 data	400902	
	Lower bytes of the channel 0950 data	400999	
	Higher bytes of the channel 0950 data	401000	
Expandable I/O 1	Lower bytes of the channel 1001 data	410001	
	Higher bytes of the channel 1001 data	410002	
	Lower bytes of the channel 1050 data	410099	
	Higher bytes of the channel 1050 data	410100	
	Lower bytes of the channel 1101 data	410101	
	Higher bytes of the channel 1101 data	410102	
	Lower bytes of the channel 1150 data	410199	
	Higher bytes of the channel 1150 data	410200	
	Lower bytes of the channel 1201 data	410201	
	Higher bytes of the channel 1201 data	410202	
	Lower bytes of the channel 1250 data	410299	
	Higher bytes of the channel 1250 data	410300	
	Lower bytes of the channel 1301 data	410301	
	Higher bytes of the channel 1301 data	410302	
	Lower bytes of the channel 1350 data	410399	
	Higher bytes of the channel 1350 data	410400	
	Lower bytes of the channel 1401 data	410401	
	Higher bytes of the channel 1401 data	410402	
	Lower bytes of the channel 1450 data	410499	
	Higher bytes of the channel 1450 data	410500	
	Lower bytes of the channel 1501 data	410501	
	Higher bytes of the channel 1501 data	410502	
	Lower bytes of the channel 1550 data	410599	
	Higher bytes of the channel 1550 data	410600	
	Expandable I/O 2	Lower bytes of the channel 2001 data	415001
		Higher bytes of the channel 2001 data	415002
		Lower bytes of the channel 2050 data	415099
		Higher bytes of the channel 2050 data	415100
Lower bytes of the channel 2101 data		415101	
Higher bytes of the channel 2101 data		415102	
Lower bytes of the channel 2150 data		415199	
Higher bytes of the channel 2150 data		415200	
Lower bytes of the channel 2201 data		415201	
Higher bytes of the channel 2201 data		415202	
Lower bytes of the channel 2250 data		415299	
Higher bytes of the channel 2250 data		415300	
Lower bytes of the channel 2301 data		415301	
Higher bytes of the channel 2301 data		415302	
Lower bytes of the channel 2350 data		415399	
Higher bytes of the channel 2350 data		415400	
Lower bytes of the channel 2401 data		415401	
Higher bytes of the channel 2401 data		415402	
Lower bytes of the channel 2450 data		415499	
Higher bytes of the channel 2450 data		415500	
Lower bytes of the channel 2501 data		415501	
Higher bytes of the channel 2501 data		415502	
Lower bytes of the channel 2550 data		415599	
Higher bytes of the channel 2550 data		415600	

Continued on next page

Unit	I/O Channel Data	Hold Register	Data Type
Expandable I/O 3	Lower bytes of the channel 3001 data	420001	32-bit signed integer
	Higher bytes of the channel 3001 data	420002	
	Lower bytes of the channel 3050 data	420099	
	Higher bytes of the channel 3050 data	420100	
	Lower bytes of the channel 3101 data	420101	
	Higher bytes of the channel 3101 data	420102	
	Lower bytes of the channel 3150 data	420199	
	Higher bytes of the channel 3150 data	420200	
	Lower bytes of the channel 3201 data	420201	
	Higher bytes of the channel 3201 data	420202	
	Lower bytes of the channel 3250 data	420299	
	Higher bytes of the channel 3250 data	420300	
	Lower bytes of the channel 3301 data	420301	
	Higher bytes of the channel 3301 data	420302	
	Lower bytes of the channel 3350 data	420399	
	Higher bytes of the channel 3350 data	420400	
	Lower bytes of the channel 3401 data	420401	
	Higher bytes of the channel 3401 data	420402	
	Lower bytes of the channel 3450 data	420499	
	Higher bytes of the channel 3450 data	420500	
Lower bytes of the channel 3501 data	420501		
Higher bytes of the channel 3501 data	420502		
Lower bytes of the channel 3550 data	420599		
Higher bytes of the channel 3550 data	420600		
Expandable I/O 4	Lower bytes of the channel 4001 data	425001	
	Higher bytes of the channel 4001 data	425002	
	Lower bytes of the channel 4050 data	425099	
	Higher bytes of the channel 4050 data	425100	
	Lower bytes of the channel 4101 data	425101	
	Higher bytes of the channel 4101 data	425102	
	Lower bytes of the channel 4150 data	425199	
	Higher bytes of the channel 4150 data	425200	
	Lower bytes of the channel 4201 data	425201	
	Higher bytes of the channel 4201 data	425202	
	Lower bytes of the channel 4250 data	425299	
	Higher bytes of the channel 4250 data	425300	
	Lower bytes of the channel 4301 data	425301	
	Higher bytes of the channel 4301 data	425302	
	Lower bytes of the channel 4350 data	425399	
	Higher bytes of the channel 4350 data	425400	
	Lower bytes of the channel 4401 data	425401	
	Higher bytes of the channel 4401 data	425402	
	Lower bytes of the channel 4450 data	425499	
	Higher bytes of the channel 4450 data	425500	
Lower bytes of the channel 4501 data	425501		
Higher bytes of the channel 4501 data	425502		
Lower bytes of the channel 4550 data	425599		
Higher bytes of the channel 4550 data	425600		

Continued on next page

#### 4.5 Modbus Function and Register Assignments

Unit	I/O Channel Data	Hold Register	Data Type	
Expandable I/O 5	Lower bytes of the channel 5001 data	430001	32-bit signed integer	
	Higher bytes of the channel 5001 data	430002		
	Lower bytes of the channel 5050 data	430099		
	Higher bytes of the channel 5050 data	430100		
	Lower bytes of the channel 5101 data	430101		
	Higher bytes of the channel 5101 data	430102		
	Lower bytes of the channel 5150 data	430199		
	Higher bytes of the channel 5150 data	430200		
	Lower bytes of the channel 5201 data	430201		
	Higher bytes of the channel 5201 data	430202		
	Lower bytes of the channel 5250 data	430299		
	Higher bytes of the channel 5250 data	430300		
	Lower bytes of the channel 5301 data	430301		
	Higher bytes of the channel 5301 data	430302		
	Lower bytes of the channel 5350 data	430399		
	Higher bytes of the channel 5350 data	430400		
	Lower bytes of the channel 5401 data	430401		
	Higher bytes of the channel 5401 data	430402		
	Lower bytes of the channel 5450 data	430499		
	Higher bytes of the channel 5450 data	430500		
	Lower bytes of the channel 5501 data	430501		
	Higher bytes of the channel 5501 data	430502		
	Lower bytes of the channel 5550 data	430599		
	Higher bytes of the channel 5550 data	430600		
	Expandable I/O 6	Lower bytes of the channel 6001 data		435001
		Higher bytes of the channel 6001 data		435002
Lower bytes of the channel 6050 data		435099		
Higher bytes of the channel 6050 data		435100		
Lower bytes of the channel 6101 data		435101		
Higher bytes of the channel 6101 data		435102		
Lower bytes of the channel 6150 data		435199		
Higher bytes of the channel 6150 data		435200		
Lower bytes of the channel 6201 data		435201		
Higher bytes of the channel 6201 data		435202		
Lower bytes of the channel 6250 data		435299		
Higher bytes of the channel 6250 data		435300		
Lower bytes of the channel 6301 data		435301		
Higher bytes of the channel 6301 data		435302		
Lower bytes of the channel 6350 data		435399		
Higher bytes of the channel 6350 data		435400		
Lower bytes of the channel 6401 data		435401		
Higher bytes of the channel 6401 data		435402		
Lower bytes of the channel 6450 data		435499		
Higher bytes of the channel 6450 data		435500		
Lower bytes of the channel 6501 data		435501		
Higher bytes of the channel 6501 data		435502		
Lower bytes of the channel 6550 data		435599		
Higher bytes of the channel 6550 data		435600		

Continued on next page

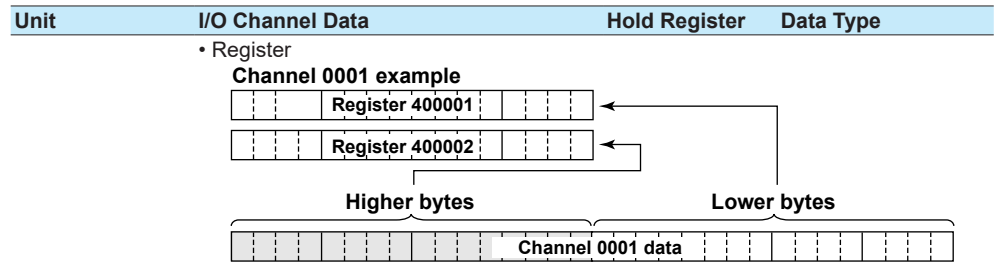

• There is no decimal place information.

- When Modbus writing is performed on a channel of a DO module, a relay output occurs from the corresponding channel of the DO module.  
Write a 0 to turn the relay off.  
Write a nonzero value to turn the relay on.  
To enable relay output from a DO module through Modbus writing, the DO channel range type must be set to Manual. ▶ See page 1-76 in section 1.6.1, "Setting the Range".

• **32-bit floating point**

Unit	I/O Channel Data	Hold Register	Data Type
GX/GP main unit	Lower bytes of the channel 0001 data	401001	32-bit floating point
	Higher bytes of the channel 0001 data	401002	
	Lower bytes of the channel 0050 data	401099	
	Higher bytes of the channel 0050 data	401100	
	Lower bytes of the channel 0101 data	401101	
	Higher bytes of the channel 0101 data	401102	
	Lower bytes of the channel 0150 data	401199	
	Higher bytes of the channel 0150 data	401200	
	Lower bytes of the channel 0201 data	401201	
	Higher bytes of the channel 0201 data	401202	
	Lower bytes of the channel 0250 data	401299	
	Higher bytes of the channel 0250 data	401300	
	Lower bytes of the channel 0301 data	401301	
	Higher bytes of the channel 0301 data	401302	
	Lower bytes of the channel 0350 data	401399	
	Higher bytes of the channel 0350 data	401400	
	Lower bytes of the channel 0401 data	401401	
	Higher bytes of the channel 0401 data	401402	
	Lower bytes of the channel 0450 data	401499	
	Higher bytes of the channel 0450 data	401500	
	Lower bytes of the channel 0501 data	401501	
	Higher bytes of the channel 0501 data	401502	
	Lower bytes of the channel 0550 data	401599	
	Higher bytes of the channel 0550 data	401600	
	Lower bytes of the channel 0601 data	401601	
	Higher bytes of the channel 0601 data	401602	
Lower bytes of the channel 0650 data	401699		
Higher bytes of the channel 0650 data	401700		
Lower bytes of the channel 0701 data	401701		
Higher bytes of the channel 0701 data	401702		
Lower bytes of the channel 0750 data	401799		
Higher bytes of the channel 0750 data	401800		
Lower bytes of the channel 0801 data	401801		
Higher bytes of the channel 0801 data	401802		
Lower bytes of the channel 0850 data	401899		
Higher bytes of the channel 0850 data	401900		

Continued on next page

#### 4.5 Modbus Function and Register Assignments

Unit	I/O Channel Data	Hold Register	Data Type
GX/GP main unit	Lower bytes of the channel 0901 data	401901	32-bit floating point
	Higher bytes of the channel 0901 data	401902	
	Lower bytes of the channel 0950 data	401999	
Expandable I/O 1	Higher bytes of the channel 0950 data	402000	
	Lower bytes of the channel 1001 data	411001	
	Higher bytes of the channel 1001 data	411002	
	Lower bytes of the channel 1050 data	411099	
	Higher bytes of the channel 1050 data	411100	
	Lower bytes of the channel 1101 data	411101	
	Higher bytes of the channel 1101 data	411102	
	Lower bytes of the channel 1150 data	411199	
	Higher bytes of the channel 1150 data	411200	
	Lower bytes of the channel 1201 data	411201	
	Higher bytes of the channel 1201 data	411202	
	Lower bytes of the channel 1250 data	411299	
	Higher bytes of the channel 1250 data	411300	
	Lower bytes of the channel 1301 data	411301	
	Higher bytes of the channel 1301 data	411302	
	Lower bytes of the channel 1350 data	411399	
	Higher bytes of the channel 1350 data	411400	
	Lower bytes of the channel 1401 data	411401	
	Higher bytes of the channel 1401 data	411402	
	Lower bytes of the channel 1450 data	411499	
	Higher bytes of the channel 1450 data	411500	
	Lower bytes of the channel 1501 data	411501	
	Higher bytes of the channel 1501 data	411502	
	Lower bytes of the channel 1550 data	411599	
	Higher bytes of the channel 1550 data	411600	

Continued on next page



Unit	I/O Channel Data	Hold Register	Data Type
Expandable I/O 2	Lower bytes of the channel 2001 data	416001	32-bit floating point
	Higher bytes of the channel 2001 data	416002	
	Lower bytes of the channel 2050 data	416099	
	Higher bytes of the channel 2050 data	416100	
	Lower bytes of the channel 2101 data	416101	
	Higher bytes of the channel 2101 data	416102	
	Lower bytes of the channel 2150 data	416199	
	Higher bytes of the channel 2150 data	416200	
	Lower bytes of the channel 2201 data	416201	
	Higher bytes of the channel 2201 data	416202	
	Lower bytes of the channel 2250 data	416299	
	Higher bytes of the channel 2250 data	416300	
	Lower bytes of the channel 2301 data	416301	
	Higher bytes of the channel 2301 data	416302	
	Higher bytes of the channel 2350 data	416399	
	Higher bytes of the channel 2350 data	416400	
	Lower bytes of the channel 2401 data	416401	
	Higher bytes of the channel 2401 data	416402	
	Higher bytes of the channel 2450 data	416499	
	Higher bytes of the channel 2450 data	416500	
Lower bytes of the channel 2501 data	416501		
Higher bytes of the channel 2501 data	416502		
Higher bytes of the channel 2550 data	416599		
Higher bytes of the channel 2550 data	416600		
Expandable I/O 3	Lower bytes of the channel 3001 data	421001	
	Higher bytes of the channel 3001 data	421002	
	Lower bytes of the channel 3050 data	421099	
	Higher bytes of the channel 3050 data	421100	
	Lower bytes of the channel 3101 data	421101	
	Higher bytes of the channel 3101 data	421102	
	Lower bytes of the channel 3150 data	421199	
	Higher bytes of the channel 3150 data	421200	
	Lower bytes of the channel 3201 data	421201	
	Higher bytes of the channel 3201 data	421202	
	Lower bytes of the channel 3250 data	421299	
	Higher bytes of the channel 3250 data	421300	
	Lower bytes of the channel 3301 data	421301	
	Higher bytes of the channel 3301 data	421302	
	Lower bytes of the channel 3350 data	421399	
	Higher bytes of the channel 3350 data	421400	
	Lower bytes of the channel 3401 data	421401	
	Higher bytes of the channel 3401 data	421402	
	Lower bytes of the channel 3450 data	421499	
	Higher bytes of the channel 3450 data	421500	
Lower bytes of the channel 3501 data	421501		
Higher bytes of the channel 3501 data	421502		
Lower bytes of the channel 3550 data	421599		
Higher bytes of the channel 3550 data	421600		

Continued on next page

#### 4.5 Modbus Function and Register Assignments

Unit	I/O Channel Data	Hold Register	Data Type
Expandable I/O 4	Lower bytes of the channel 4001 data	426001	
	Higher bytes of the channel 4001 data	426002	
	Lower bytes of the channel 4050 data	426099	
	Higher bytes of the channel 4050 data	426100	
	Lower bytes of the channel 4101 data	426101	
	Higher bytes of the channel 4101 data	426102	
	Lower bytes of the channel 4150 data	426199	
	Higher bytes of the channel 4150 data	426200	
	Lower bytes of the channel 4201 data	426201	
	Higher bytes of the channel 4201 data	426202	
	Lower bytes of the channel 4250 data	426299	
	Higher bytes of the channel 4250 data	426300	
	Lower bytes of the channel 4301 data	426301	
	Higher bytes of the channel 4301 data	426302	
	Lower bytes of the channel 4350 data	426399	
	Higher bytes of the channel 4350 data	426400	
	Lower bytes of the channel 4401 data	426401	
	Higher bytes of the channel 4401 data	426402	
	Lower bytes of the channel 4450 data	426499	
	Higher bytes of the channel 4450 data	426500	
	Lower bytes of the channel 4501 data	426501	
	Higher bytes of the channel 4501 data	426502	
	Lower bytes of the channel 4550 data	426599	
	Higher bytes of the channel 4550 data	426600	

Continued on next page

Unit	I/O Channel Data	Hold Register	Data Type	
Expandable I/O 5	Lower bytes of the channel 5001 data	431001	32-bit floating point	
	Higher bytes of the channel 5001 data	431002		
	Lower bytes of the channel 5050 data	431099		
	Higher bytes of the channel 5050 data	431100		
	Lower bytes of the channel 5101 data	431101		
	Higher bytes of the channel 5101 data	431102		
	Lower bytes of the channel 5150 data	431199		
	Higher bytes of the channel 5150 data	431200		
	Lower bytes of the channel 5201 data	431201		
	Higher bytes of the channel 5201 data	431202		
	Lower bytes of the channel 5250 data	431299		
	Higher bytes of the channel 5250 data	431300		
	Lower bytes of the channel 5301 data	431301		
	Higher bytes of the channel 5301 data	431302		
	Lower bytes of the channel 5350 data	431399		
	Higher bytes of the channel 5350 data	431400		
	Lower bytes of the channel 5401 data	431401		
	Higher bytes of the channel 5401 data	431402		
	Lower bytes of the channel 5450 data	431499		
	Higher bytes of the channel 5450 data	431500		
	Lower bytes of the channel 5501 data	431501		
	Higher bytes of the channel 5501 data	431502		
	Lower bytes of the channel 5550 data	431599		
	Higher bytes of the channel 5550 data	431600		
	Expandable I/O 6	Lower bytes of the channel 6001 data		436001
		Higher bytes of the channel 6001 data		436002
Lower bytes of the channel 6050 data		436099		
Higher bytes of the channel 6050 data		436100		
Lower bytes of the channel 6101 data		436101		
Higher bytes of the channel 6101 data		436102		
Lower bytes of the channel 6150 data		436199		
Higher bytes of the channel 6150 data		436200		
Lower bytes of the channel 6201 data		436201		
Higher bytes of the channel 6201 data		436202		
Lower bytes of the channel 6250 data		436299		
Higher bytes of the channel 6250 data		436300		
Lower bytes of the channel 6301 data		436301		
Higher bytes of the channel 6301 data		436302		
Lower bytes of the channel 6350 data		436399		
Higher bytes of the channel 6350 data		436400		
Lower bytes of the channel 6401 data		436401		
Higher bytes of the channel 6401 data		436402		
Lower bytes of the channel 6450 data		436499		
Higher bytes of the channel 6450 data		436500		
Lower bytes of the channel 6501 data		436501		
Higher bytes of the channel 6501 data		436502		
Lower bytes of the channel 6550 data		436599		
Higher bytes of the channel 6550 data		436600		

## • 16-bit Signed Integer

Unit	I/O Channel Data	Hold Register	Data Type
GX/GP main unit	Channel 0001 data	402001	16-bit signed integer
	Channel 0050 data	402050	
	Channel 0101 data	402051	
	Channel 0150 data	402100	
	Channel 0201 data	402101	
	Channel 0250 data	402150	
	Channel 0301 data	402151	
	Channel 0350 data	402200	
	Channel 0401 data	402201	
	Channel 0450 data	402250	
	Channel 0501 data	402251	
	Channel 0550 data	402300	
	Channel 0601 data	402301	
Channel 0650 data	402350		
Channel 0701 data	402351		
Channel 0750 data	402400		
Channel 0801 data	402401		
Channel 0850 data	402450		
Channel 0901 data	402451		
Channel 0950 data	402500		
Expandable I/O 1	Channel 1001 data	412001	
	Channel 1050 data	412050	
	Channel 1101 data	412051	
	Channel 1150 data	412100	
	Channel 1201 data	412101	
	Channel 1250 data	412150	
	Channel 1301 data	412151	
	Channel 1350 data	412200	
	Channel 1401 data	412201	
Channel 1450 data	412250		
Channel 1501 data	412251		
Channel 1550 data	412300		
Expandable I/O 2	Channel 2001 data	417001	
	Channel 2050 data	417050	
	Channel 2101 data	417051	
	Channel 2150 data	417100	
	Channel 2201 data	417101	
	Channel 2250 data	417150	
	Channel 2301 data	417151	
Channel 2350 data	417200		
Channel 2401 data	417201		
Channel 2450 data	417250		
Expandable I/O	Channel 2501 data	417251	
	Channel 2550 data	417300	

Continued on next page

Unit	I/O Channel Data	Input Register	Data Type	
Expandable I/O 3	Channel 3001 data	422001	16-bit signed integer	
	Channel 3050 data	422050		
	Channel 3101 data	422051		
	Channel 3150 data	422100		
	Channel 3201 data	422101		
	Channel 3250 data	422150		
	Channel 3301 data	422151		
	Channel 3350 data	422200		
	Channel 3401 data	422201		
	Channel 3450 data	422250		
	Channel 3501 data	422251		
	Channel 3550 data	422300		
	Expandable I/O 4	Channel 4001 data		427001
		Channel 4050 data		427050
Channel 4101 data		427051		
Channel 4150 data		427100		
Channel 4201 data		427101		
Channel 4250 data		427150		
Channel 4301 data		427151		
Channel 4350 data		427200		
Channel 4401 data		427201		
Channel 4450 data		427250		
Channel 4501 data		427251		
Channel 4550 data		427300		
Expandable I/O 5		Channel 5001 data	432001	
		Channel 5050 data	432050	
	Channel 5101 data	432051		
	Channel 5150 data	432100		
	Channel 5201 data	432101		
	Channel 5250 data	432150		
	Channel 5301 data	432151		
	Channel 5350 data	432200		
	Channel 5401 data	432201		
	Channel 5450 data	432250		
	Channel 5501 data	432251		
	Channel 5550 data	432300		
	Expandable I/O 6	Channel 6001 data	437001	
		Channel 6050 data	437050	
Channel 6101 data		437051		
Channel 6150 data		437100		

Continued on next page

#### 4.5 Modbus Function and Register Assignments

Unit	I/O Channel Data	Input Register	Data Type
Expandable I/O 6	Channel 6201 data	437101	16-bit signed integer
	Channel 6250 data	437150	
	Channel 6301 data	437151	
	Channel 6350 data	437200	
	Channel 6401 data	437201	
Channel 6450 data	437250		
Channel 6501 data	437251		
Channel 6550 data	437300		

#### I/O Channel Data Status Information

Unit	I/O Channel Data	Hold Register	Data Type
GX/GP main unit	Channel 0001 status information	402501	16-bit signed integer
	Channel 0050 status information	402550	
	Channel 0101 status information	402551	
	Channel 0150 status information	402600	
	Channel 0201 status information	402601	
	Channel 0250 status information	402650	
	Channel 0301 status information	402651	
	Channel 0350 status information	402700	
	Channel 0401 status information	402701	
	Channel 0450 status information	402750	
	Channel 0501 status information	402751	
	Channel 0550 status information	402800	
	Channel 0601 status information	402801	
Channel 0650 status information	402850		
Channel 0701 status information	402851		
Channel 0750 status information	402900		
Channel 0801 status information	402901		
Channel 0850 status information	402950		
Channel 0901 status information	402951		
Channel 0950 status information	403000		
Expandable I/O 1	Channel 1001 status information	412501	
	Channel 1050 status information	412550	
	Channel 1101 status information	412551	
	Channel 1150 status information	412600	
	Channel 1201 status information	412601	
Channel 1250 status information	412650		
Channel 1301 status information	412651		
Channel 1350 status information	412700		
Expandable I/O 1	Channel 1401 status information	412701	
	Channel 1450 status information	412750	
	Channel 1501 status information	412751	
Channel 1550 status information	412800		

Continued on next page

Unit	I/O Channel Data	Input Register	Data Type
Expandable I/O 2	Channel 2001 status information	417501	16-bit signed integer
	Channel 2050 status information	417550	
	Channel 2101 status information	417551	
	Channel 2150 status information	417600	
	Channel 2201 status information	417601	
	Channel 2250 status information	417650	
	Channel 2301 status information	417651	
	Channel 2350 status information	417700	
	Channel 2401 status information	417701	
	Channel 2450 status information	417750	
Channel 2501 status information	417751		
Channel 2550 status information	417800		
Expandable I/O 3	Channel 3001 status information	422501	
	Channel 3050 status information	422550	
	Channel 3101 status information	422551	
	Channel 3150 status information	422600	
	Channel 3201 status information	422601	
	Channel 3250 status information	422650	
	Channel 3301 status information	422651	
	Channel 3350 status information	422700	
	Channel 3401 status information	422701	
	Channel 3450 status information	422750	
Channel 3501 status information	422751		
Channel 3550 status information	422800		
Expandable I/O 4	Channel 4001 status information	427501	
	Channel 4050 status information	427550	
	Channel 4101 status information	427551	
	Channel 4150 status information	427600	
	Channel 4201 status information	427601	
	Channel 4250 status information	427650	
	Channel 4301 status information	427651	
	Channel 4350 status information	427700	
	Channel 4401 status information	427701	
	Channel 4450 status information	427750	
Channel 4501 status information	427751		
Channel 4550 status information	427800		

Continued on next page

#### 4.5 Modbus Function and Register Assignments

Unit	I/O Channel Data	Input Register	Data Type	
Expandable I/O 5	Channel 5001 status information	432501	16-bit signed integer	
	Channel 5050 status information	432550		
	Channel 5101 status information	432551		
	Channel 5150 status information	432600		
	Channel 5201 status information	432601		
	Channel 5250 status information	432650		
	Channel 5301 status information	432651		
	Channel 5350 status information	432700		
	Channel 5401 status information	432701		
	Channel 5450 status information	432750		
	Channel 5501 status information	432751		
	Channel 5550 status information	432800		
	Expandable I/O 6	Channel 6001 status information		437501
		Channel 6050 status information		437550
		Channel 6101 status information		437551
Channel 6150 status information		437600		
Channel 6201 status information		437601		
Channel 6250 status information		437650		
Channel 6301 status information		437651		
Channel 6350 status information		437700		
Channel 6401 status information		437701		
Channel 6450 status information		437750		
Channel 6501 status information		437751		
Channel 6550 status information		437800		

- There is no decimal place information.

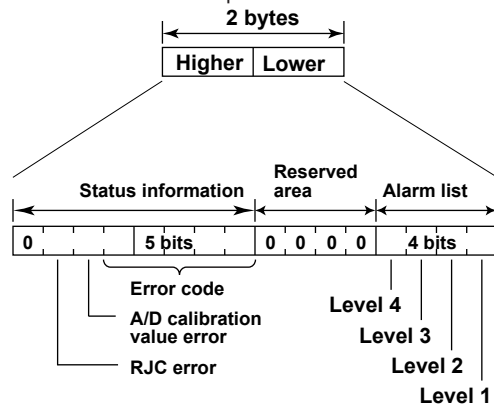

Error code	Meaning
0	No error
1	Skip
2	+Over
3	-Over
4	+Burnout
5	-Burnout
6	A/D error
7	Invalid data
16	Computation error
17	Communication error



### Continuous Channel Data Read/Write Area

The GX/GP reserves up to 50 channels of register area per module.

For example, reading 100 channels of data from 10 analog input modules through normal input registers would be inefficient because there would be a lot of empty registers.

The “continuous channel data read/write area” is a special area that enables continuous reading and writing by limiting the number of channels of each module to 10. It is for I/O channels installed in the GX/GP main unit.

### I/O Channel Data

- 32-bit Signed Integer

I/O Channel Data	Hold Register	Data Type
Lower bytes of the channel 0001 data	404001	32-bit signed integer
Higher bytes of the channel 0001 data	404002	
Lower bytes of the channel 0010 data	404019	
Higher bytes of the channel 0010 data	404020	
Lower bytes of the channel 0101 data	404021	
Higher bytes of the channel 0101 data	404022	
Lower bytes of the channel 0110 data	404039	
Higher bytes of the channel 0110 data	404040	
Lower bytes of the channel 0201 data	404041	
Higher bytes of the channel 0201 data	404042	
Lower bytes of the channel 0210 data	404059	
Higher bytes of the channel 0210 data	404060	
Lower bytes of the channel 0301 data	404061	
Higher bytes of the channel 0301 data	404062	
Lower bytes of the channel 0310 data	404079	
Higher bytes of the channel 0310 data	404080	
Lower bytes of the channel 0401 data	404081	
Higher bytes of the channel 0401 data	404082	
Lower bytes of the channel 0410 data	404099	
Higher bytes of the channel 0410 data	404100	
Lower bytes of the channel 0501 data	404101	
Higher bytes of the channel 0501 data	404102	
Lower bytes of the channel 0510 data	404119	
Higher bytes of the channel 0510 data	404120	
Lower bytes of the channel 0601 data	404121	
Higher bytes of the channel 0601 data	404122	
Lower bytes of the channel 0610 data	404139	
Higher bytes of the channel 0610 data	404140	
Lower bytes of the channel 0701 data	404141	
Higher bytes of the channel 0701 data	404142	
Lower bytes of the channel 0710 data	404159	
Higher bytes of the channel 0710 data	404160	
Lower bytes of the channel 0801 data	404161	
Higher bytes of the channel 0801 data	404162	
Lower bytes of the channel 0810 data	404179	
Higher bytes of the channel 0810 data	404180	
Lower bytes of the channel 0901 data	404181	
Higher bytes of the channel 0901 data	404182	
Lower bytes of the channel 0910 data	404199	
Higher bytes of the channel 0910 data	404200	

- **32-bit floating point**

I/O Channel Data	Hold Register	Data Type
Lower bytes of the channel 0001 data	404201	32-bit floating point
Higher bytes of the channel 0001 data	404202	
Lower bytes of the channel 0010 data	404219	
Higher bytes of the channel 0010 data	404220	
Lower bytes of the channel 0101 data	404221	
Higher bytes of the channel 0101 data	404222	
Lower bytes of the channel 0110 data	404239	
Higher bytes of the channel 0110 data	404240	
Lower bytes of the channel 0201 data	404241	
Higher bytes of the channel 0201 data	404242	
Lower bytes of the channel 0210 data	404259	
Higher bytes of the channel 0210 data	404260	
Lower bytes of the channel 0301 data	404261	
Higher bytes of the channel 0301 data	404262	
Lower bytes of the channel 0310 data	404279	
Higher bytes of the channel 0310 data	404280	
Lower bytes of the channel 0401 data	404281	
Higher bytes of the channel 0401 data	404282	
Lower bytes of the channel 0410 data	404299	
Higher bytes of the channel 0410 data	404300	
Lower bytes of the channel 0501 data	404301	
Higher bytes of the channel 0501 data	404302	
Lower bytes of the channel 0510 data	404319	
Higher bytes of the channel 0510 data	404320	
Lower bytes of the channel 0601 data	404321	
Higher bytes of the channel 0601 data	404322	
Lower bytes of the channel 0610 data	404339	
Higher bytes of the channel 0610 data	404340	
Lower bytes of the channel 0701 data	404341	
Higher bytes of the channel 0701 data	404342	
Lower bytes of the channel 0710 data	404359	
Higher bytes of the channel 0710 data	404360	
Lower bytes of the channel 0801 data	404361	
Higher bytes of the channel 0801 data	404362	
Lower bytes of the channel 0810 data	404379	
Higher bytes of the channel 0810 data	404380	
Lower bytes of the channel 0901 data	404381	
Higher bytes of the channel 0901 data	404382	
Lower bytes of the channel 0910 data	404399	
Higher bytes of the channel 0910 data	404400	

- **16-bit Signed Integer**

I/O Channel Data	Hold Register	Data Type
Channel 0001 data	404401	16-bit signed integer
Channel 0010 data	404410	
Channel 0101 data	404411	
Channel 0110 data	404420	
Channel 0201 data	404421	
Channel 0210 data	404430	
Channel 0301 data	404431	
Channel 0310 data	404440	
Channel 0401 data	404441	
Channel 0410 data	404450	
Channel 0501 data	404451	
Channel 0510 data	404460	
Channel 0601 data	404461	
Channel 0650 data	404470	
Channel 0701 data	404471	
Channel 0710 data	404480	
Channel 0801 data	404481	
Channel 0810 data	404490	
Channel 0901 data	404491	
Channel 0910 data	404500	

**I/O Channel Data Status Information**

I/O Channel Data	Hold Register	Data Type
Channel 0001 status information	404501	16-bit signed integer
Channel 0010 status information	404510	
Channel 0101 status information	404511	
Channel 0110 status information	404520	
Channel 0201 status information	404521	
Channel 0210 status information	404530	
Channel 0301 status information	404531	
Channel 0310 status information	404540	
Channel 0401 status information	404541	
Channel 0410 status information	404550	
Channel 0501 status information	404551	
Channel 0510 status information	404560	
Channel 0601 status information	404561	
Channel 0610 status information	404570	
Channel 0701 status information	404571	
Channel 0710 status information	404580	
Channel 0801 status information	404581	
Channel 0810 status information	404590	
Channel 0901 status information	404591	
Channel 0910 status information	404600	

• There is no decimal place information.

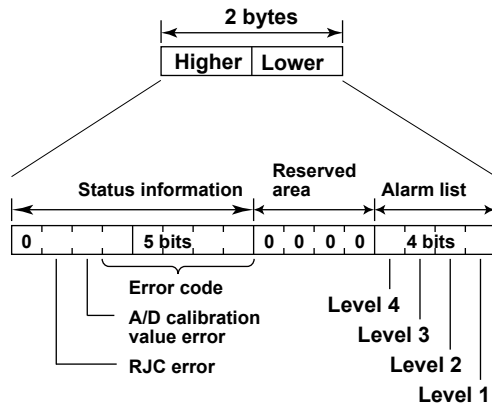

Error code	Meaning
0	No error
1	Skip
2	+Over
3	-Over
4	+Burnout
5	-Burnout
6	A/D error
7	Invalid data
16	Computation error
17	Communication error

**Communication Channel**

Data	Hold Register	Data Type
Lower bytes of the input data of channel C001	405001	32-bit signed integer
Higher bytes of the input data of channel C001	405002	
Lower bytes of the input data of channel C500	405999	32-bit floating point
Higher bytes of the input data of channel C500	406000	
• There is no decimal place information.		
Lower bytes of the input data of channel C001	406001	32-bit floating point
Higher bytes of the input data of channel C001	406002	
Lower bytes of the input data of channel C500	406999	32-bit floating point
Higher bytes of the input data of channel C500	407000	
• Note when a client (master) device writes data		
Input range: -9.9999E29 to -1E-30, 0, 1E-30 to 9.9999E29		
Values outside this range when used in a math channel will result in computation error.		
Channel C001 input data	407001	16-bit signed integer
Channel C500 input data	407500	
Channel C001 status information	407501	
Channel C500 status information	408000	
• Status register configuration		
This is the same as that of the I/O channel data status information.		

**Internal Switch<sup>1</sup>**

Data	Hold Register	Supplementary Information	Data Type
S001 input data	408001	OFF: 0, ON: Not 0	16-bit signed integer
S100 input data	408100	OFF: 0, ON: Not 0	

- <sup>1</sup> To control internal switches through Modbus writing, the internal switch must be set to Manual.  
▶ See page 1-210 in section 1.23.5, "Setting Internal Switches".

**GX/GP Operation Setting**

Data	Hold Register	Supplementary Information	Data Type
Starts or stops recording (when multi batch is not in use)	409001	0: Fixed at 0 when reading 1: Start recording 2: Stop recording	16-bit signed integer
Multi batch 1 to 12	409001	0: Fixed at 0 when reading	
Starts or stops recording (when multi batch is in use)	409012	1: Start recording 2: Stop recording	
Computation operation (when multi batch is not in use)	409021	0: Fixed at 0 when reading 1: Start computation 2: Stop computation 3: Reset computation 4: Clear the computation dropout status display	
Multi batch 1 to 12	409021	0: Fixed at 0 when reading	
Computation operation (when multi batch is in use)	409032	1: Start computation (all) 2: Stop computation (all) 3: Reset computation (by batch) 4: Clear the computation dropout status display (all)	
All alarm ACK	409041	0: Fixed at 0 when reading 1: Clear alarm output	
Individual alarm ACK	409042	Alarm ACK channel type specification 0: Fixed at 0 when reading 1: I/O channel 2: Math channel 3: Communication channel	

Continued on next page

#### 4.5 Modbus Function and Register Assignments

Data	Hold Register	Supplementary Information	Data Type
Individual alarm ACK	409043	Alarm ACK channel number specification 0: Fixed at 0 when reading I/O channel: 1 to 6932 Math channel: 1 to 100 Communication channel: 1 to 500	16-bit signed integer
	409044	Alarm ACK alarm level specification 0: Fixed at 0 when reading 1: Alarm level 1 ACK 2: Alarm level 2 ACK 3: Alarm level 3 ACK 4: Alarm level 4 ACK	
Manual trigger, manual sample, snapshot, timeout	409051	0: Fixed at 0 when reading 1: Execute manual sampling 2: Generate a manual trigger 3: Take a snapshot 4: Cause a timeout in display data 5: Cause a timeout in event data	
Synchronize time using SNTP	409052	0: Fixed at 0 when reading 1: Execute manual SNTP	
Start/stop the e-mail transmission function	409053	0: Fixed at 0 when reading 1: Start e-mail transmission 2: Stop e-mail transmission	
Recover Modbus manually	409054	0: Fixed at 0 when reading 1: Manually recover the Modbus client. 2: Manually recover the Modbus master.	
Reset a relative timer	409055	0: Fixed at 0 when reading 1 to 12: Reset the specified timer 100: Reset all timers	
Reset a match time timer	409056	0: Fixed at 0 when reading 1 to 12: Reset the specified timer 100: Reset all timers	
All loop control run/stop	409057	1: All loops run 2: All Loops stop	

Continued on next page

Data	Hold Register	Supplementary Information	Data Type
Property display area Display information settings	409091	0: Range, unit, tag name information of continuous measurement channels 0001 to 6510 10: Range, unit, tag name information of math channels 0001 to 950 11: Range, unit, tag name information of math channels 1001 to 1950 12: Range, unit, tag name information of math channels 2001 to 2950 13: Range, unit, tag name information of math channels 3001 to 3950 14: Range, unit, tag name information of math channels 4001 to 4950 15: Range, unit, tag name information of math channels 5001 to 5950 16: Range, unit, tag name information of math channels 6001 to 6950 20: Range, unit, tag name information of math channels A001 to A200 30: Range, unit, tag name information of communication channels C001 to C500	16-bit signed integer
Year	409101 <sup>1</sup>	0 to 65535	16-bit signed integer
Month	409102 <sup>1</sup>	1 to 12	
Day	409103 <sup>1</sup>	1 to 31	
Hour	409104 <sup>1</sup>	0 to 23	
Minute	409105 <sup>1</sup>	0 to 59	
Second	409106 <sup>1</sup>	0 to 59	
1 Read only. Cannot be written to.			
Write a message (specify the write method)	409201	0: Fixed at 0 when reading 1: Write a preset message 2: Write a free message	16-bit signed integer
Write a message (message number)	409202	0: Fixed at 0 when reading Preset: 1 to 100 Free: 1 to 10	
Write a message (specify the write destination)	409203	0: All display groups; fixed at 0 when reading 1 or greater: The specified display group	
Write a message (batch group number)	409204	0: Fixed at 0 when reading 1 or greater: Batch group number	
Write a message (free message)	409205	0: Fixed at 0 when reading UTF-8 characters (2 characters) Up to 35 characters (except the number of valid characters is 32) Ignored for preset messages Attach a terminator at the end	

Continued on next page

#### 4.5 Modbus Function and Register Assignments

Data	Hold Register	Supplementary Information	Data Type
Write a message (free message)	409230	0: Fixed at 0 when reading UTF-8 characters (2 characters) Up to 35 characters (except the number of valid characters is 32) Ignored for preset messages Attach a terminator at the end	16-bit signed integer
Batch, lot number	409301	Lower bytes of the lot number	32-bit signed integer
	409302	Higher bytes of the lot number	
	409303	Batch number UTF-8 characters (2 characters) Up to 32 characters [attach the terminator '\0' at the end]	16-bit signed integer
Batch, lot number (multi batch support)	409319	Batch number UTF-8 characters (2 characters) Up to 32 characters [attach the terminator '\0' at the end]	16-bit signed integer
	409351	1 or greater: Batch group number When reading, the batch group number that performed writing previously Default value: 0	
	409352	Lower bytes of the lot number When reading, the lot number corresponding to the above batch group number 0 if there is no corresponding batch group number	
Batch, lot number	409353	Higher bytes of the lot number When reading, the lot number corresponding to the above batch group number 0 if there is no corresponding batch group number	32-bit signed integer
	409354	Batch number UTF-8 characters (2 characters) Up to 32 characters [attach the terminator '\0' at the end] When reading, the batch number corresponding to the above batch group number NULL character if there is no corresponding batch group number	
Batch, lot number	409379	Batch number UTF-8 characters (2 characters) Up to 32 characters [attach the terminator '\0' at the end] When reading, the batch number corresponding to the above batch group number NULL character if there is no corresponding batch group number	16-bit signed integer

Continued on next page



Data	Hold Register	Supplementary Information	Data Type
Batch Comment	409401	1 to12: Batch group number When reading, the batch group number that performed writing previously Default value: 0 No multi batch:1	16-bit signed integer
	409402	Batch comment number When reading, the batch comment number that performed writing previously Default value: 0	
	409403	Comment string UTF-8 characters (2 characters) Up to 32 characters [attach the terminator '\0' at the end] When reading, the batch comment text corresponding to the above batch group number and batch comment number NULL character if there is no corresponding batch group number or batch comment number	
	409428	Comment string UTF-8 characters (2 characters) Up to 32 characters [attach the terminator '\0' at the end] When reading, the batch comment text corresponding to the above batch group number and batch comment number NULL character if there is no corresponding batch group number or batch comment number	

Continued on next page

#### 4.5 Modbus Function and Register Assignments

Data	Hold Register	Supplementary Information	Data Type
Batch text field title	409451	1 to12: Batch group number When reading, the batch group number that performed writing previously Default value: 0 No multi batch:1	16-bit signed integer
	409452	Batch text Text field number When reading, the batch text field number that performed writing previously Default value: 0	
	409453	Batch Text field Title UTF-8 characters (2 characters) Up to 20 characters [attach the terminator '\0' at the end] When reading, the batch field title text corresponding to the above batch group number and batch text field number NULL character if there is no corresponding batch group number or batch text field number	
	409478	Batch Text field Title UTF-8 characters (2 characters) Up to 20 characters [attach the terminator '\0' at the end] When reading, the batch field title text corresponding to the above batch group number and batch text field number NULL character if there is no corresponding batch group number or batch text field number	

Continued on next page

Data	Hold Register	Supplementary Information	Data Type
Batch text field string	409501	1 or greater: Batch group number When reading, the batch group number that performed writing previously Default value: 0	16-bit signed integer
	409502	Batch text Text field number When reading, the batch text field number that performed writing previously Default value: 0	
	409503	Batch Text field Characters UTF-8 characters (2 characters) Up to 30 characters [attach the terminator '\0' at the end] When reading, the batch field text corresponding to the above batch group number and batch text field number NULL character if there is no corresponding batch group number or batch text field number	
	409528	Batch Text field Characters UTF-8 characters (2 characters) Up to 30 characters [attach the terminator '\0' at the end] When reading, the batch field text corresponding to the above batch group number and batch text field number NULL character if there is no corresponding batch group number or batch text field number	
<b>Program operation</b>			
Pattern number switching	409601	1 to 99	
Program operation switching	409602	1: Program operation stop 2: Program operation run	
Hold-on switching	409603	1: Release hold 2: Hold	
Advance instruction	409604	1: Advance instruction	
<b>Settings</b>			
Alarm setting (channel type)	409701	1: I/O channel 2: Math channel 3: Communication channel	
Alarm setting (channel number)	409702	I/O channel: 1 to 6932 Math channel: 1 to 200 Communication channel: 1 to 500	
Alarm setting (alarm level)	409703	1 to 4: Alarm level	
Alarm type	409704	0: OFF 1: High limit alarm 2: Low limit alarm 3: High limit on rate-of-change alarm 4: Low limit on rate-of-change alarm 5: Delay high limit alarm 6: Delay low limit alarm 7: Difference high limit alarm 8: Difference low limit alarm	

Continued on next page

#### 4.5 Modbus Function and Register Assignments

---

Data	Hold Register	Supplementary Information	Data Type
Alarm setpoint	409705	Alarm setpoint	32-bit signed integer
Alarm delay setting (channel type)	409711	1: I/O channel 2: Math channel 3: Communication channel	16-bit signed integer
Alarm delay setting (channel number)	409712	I/O channel: 1 to 6932 Math channel: 1 to 200 Communication channel: 1 to 500	16-bit signed integer
Alarm delay	409713	Alarm delay seconds	32-bit signed integer

## 4.5.6 Coil

Coil registers can only be accessed from the GX/GP channels. The coil area is both readable and writable. The registers contain 1-bit data. The registers take on the value of 0 when the data is 0 and the value of 1 otherwise to indicate the data or status.

### I/O Channel Data

Type	I/O Channel Data	Register	Read/Write	Data Type
I/O Channel data	Channel 0001 data	00001	R/W	Bit string
	Channel 0050 data	00050		
	Channel 0101 data	00051		
	Channel 0150 data	00100		
	Channel 0201 data	00101		
	Channel 0250 data	00150		
	Channel 0301 data	00151		
	Channel 0350 data	00200		
	Channel 0401 data	00201		
	Channel 0450 data	00250		
	Channel 0501 data	00251		
	Channel 0550 data	00300		
	Channel 0601 data	00301		
Channel 0650 data	00350			
Channel 0701 data	00351			
Channel 0750 data	00400			
Channel 0801 data	00401			
Channel 0850 data	00450			
Channel 0901 data	00451			
Channel 0950 data	00500			
I/O Channel status information	Channel 0001 data	00501	R	Bit string
	Channel 0050 data	00550		
	Channel 0101 data	00551		
	Channel 0150 data	00600		
	Channel 0201 data	00601		
	Channel 0250 data	00650		
	Channel 0301 data	00651		
	Channel 0350 data	00700		
	Channel 0401 data	00701		
	Channel 0450 data	00750		
	Channel 0501 data	00751		
	Channel 0550 data	00800		
	Channel 0601 data	00801		
	Channel 0650 data	00850		

Continued on next page

## 4.5 Modbus Function and Register Assignments

Type	I/O Channel Data	Register	Read/Write	Data Type
I/O Channel status information	Channel 0701 data	00851	R	Bit string
	Channel 0750 data	00900		
	Channel 0801 data	00901		
	Channel 0850 data	00950		
I/O Channel status information	Channel 0901 data	00951	R	Bit string
	Channel 0950 data	01000		

### Communication Channel Data

Type	Communication Channel Data	Register	Read/Write	Data Type
Communication channel data	Channel C001 data	01001	R/W	Bit string
	Channel C300 data	01300		
Communication channel status information	Channel C001 data	01501	R	Bit string
	Channel C300 data	01800		

### Internal Switch Data

Type	Internal Switch data	Register	Read/Write	Data Type
Internal switch data	Channel S001 data	02001	R/W	Bit string
	Channel S100 data	02100		

## 4.5.7 Input Relay

Input relay registers can only be accessed from the GX/GP channels. The input relay area is both readable and writable. The registers contain 1-bit data. The registers take on the value of 0 when the data is 0 and the value of 1 otherwise to indicate the data or status.

### I/O Channel Data

Type	I/O Channel Data	Register	Read/Write	Data Type
I/O Channel Data	Channel 0001 data	10001	R	Bit string
	Channel 0050 data	10050		
	Channel 0101 data	10051		
	Channel 0150 data	10100		
	Channel 0201 data	10101		
	Channel 0250 data	10150		
	Channel 0301 data	10151		
	Channel 0350 data	10200		
	Channel 0401 data	10201		
	Channel 0450 data	10250		
	Channel 0501 data	10251		
	Channel 0550 data	10300		
	Channel 0601 data	10301		
Channel 0650 data	10350			
Channel 0701 data	10351			
Channel 0750 data	10400			

Continued on next page

Type	I/O Channel Data	Register	Read/Write	Data Type
I/O Channel Data	Channel 0801 data	10401	R	Bit string
	Channel 0850 data	10450		
	Channel 0901 data	10451		
	Channel 0950 data	10500		
I/O Channel status information	Channel 0001 data	10501	R	Bit string
	Channel 0050 data	10550		
	Channel 0101 data	10551		
	Channel 0150 data	10600		
	Channel 0201 data	10601		
	Channel 0250 data	10650		
	Channel 0301 data	00651		
	Channel 0350 data	10700		
	Channel 0401 data	10701		
	Channel 0450 data	10750		
	Channel 0501 data	10751		
	Channel 0550 data	10800		
	Channel 0601 data	10801		
	Channel 0650 data	10850		
	Channel 0701 data	10851		
	Channel 0750 data	10900		
	Channel 0801 data	10901		
	Channel 0850 data	10950		
	Channel 0901 data	10951		
	Channel 0950 data	11000		

### Math Channel Data

Type	Communication Channel data	Register	Read/Write	Data Type
Math Channel data	Channel A001 data	11001	R	Bit string
	Channel A200 data	11200		
Math Channel status information	Channel A001 data	11501	R	
	Channel A200 data	11700		

### 4.5.8 Property area

Property area is a register area in which the data that can be read can be changed by changing the channel property change register value.

Item	Description
Property area range	440000 to 465000 (hold register)
Channel property change register	409091 (hold register)

### Setting Register

#### Channel property change register

Description	Detail	Start register	End register	Data Type	Supplementary description
Command system	Property area display information setting	409091	409091	16-bit signed integer	0: Range, unit, tag name information of continuous measurement channels 0001 to 6510 10: Range, unit, tag name information of I/O channels 0001 to 0950 11: Range, unit, tag name information of I/O channels 1001 to 1950 12: Range, unit, tag name information of I/O channels 2001 to 2950 13: Range, unit, tag name information of I/O channels 3001 to 3950 14: Range, unit, tag name information of I/O channels 4001 to 4950 15: Range, unit, tag name information of I/O channels 5001 to 5950 16: Range, unit, tag name information of I/O channels 6001 to 6950 20: Range, unit, tag name information of math channels A001 to A200 30: Range, unit, tag name information of communication channels C001 to C500

---



## Property Details

### Property 0 (for continuous measurement channel information)

Unit	I/O channel information	Start register	End register	Register type	Remarks
GX/GP	Channel 0001 information	440001	440040	16-bit signed integer	High and low limit range, unit, tag name writing not allowed 0 if it does not exist.
	Channel 0002 information	440041	440080		
	Channel 0010 information	440361	440400		
	Channel 0101 information	440401	440440		
	Channel 0102 information	440441	440480		
	Channel 0110 information	440761	440800		
	Channel 0201 information	440801	440840		
	Channel 0202 information	440841	440880		
	Channel 0210 information	441161	441200		
	Channel 0301 information	441201	441240		
	Channel 0302 information	441241	441280		
	Channel 0310 information	441561	441600		
	Channel 0401 information	441601	441640		
	Channel 0402 information	441641	441680		
	Channel 0410 information	441961	442000		
	Channel 0501 information	442001	442040		
	Channel 0502 information	442041	442080		
	Channel 0510 information	442361	442400		
	Channel 0601 information	442401	442440		
	Channel 0602 information	442441	442480		
	Channel 0610 information	442761	442800		
	Channel 0701 information	442801	442840		
	Channel 0702 information	442841	442880		
	Channel 0710 information	443161	443200		
	Channel 0801 information	443201	443240		
	Channel 0802 information	443241	443280		
	Channel 0810 information	443561	443600		
	Channel 0901 information	443601	443640		
	Channel 0902 information	443641	443680		
	Channel 0910 information	443961	444000		
Expandable I/O 1	Channel 1001 information	444001	444040		
	Channel 1002 information	444041	444080		
	Channel 1010 information	444361	444400		
	Channel 1101 information	444401	444440		
	Channel 1102 information	444441	444480		
	Channel 1110 information	444761	444800		
	Channel 1201 information	444801	444840		
	Channel 1202 information	444841	444880		
	Channel 1210 information	445161	445200		

Continued on next page

#### 4.5 Modbus Function and Register Assignments

Unit	I/O channel information	Start register	End register	Register type	Remarks	
Expandable I/O 1	Channel 1301 information	445201	445240	16-bit signed integer	High and low limit range, unit, tag name writing not allowed 0 if it does not exist.	
	Channel 1302 information	445241	445280			
	Channel 1310 information	445561	445600			
	Channel 1401 information	445601	445640			
	Channel 1402 information	445641	445680			
	Channel 1410 information	445961	446000			
	Channel 1501 information	446001	446040			
	Channel 1502 information	446041	446080			
	Channel 1510 information	446361	446400			
	Expandable I/O 2	Channel 2001 information	446401			446440
		Channel 2002 information	446441			446480
		Channel 2010 information	446761			446800
		Channel 2101 information	446801			446840
		Channel 2102 information	446841			446880
Channel 2110 information		447161	447200			
Channel 2201 information		447201	447240			
Channel 2202 information		447241	447280			
Channel 2210 information		447561	447600			
Channel 2301 information		447601	447640			
Channel 2302 information		447641	447680			
Channel 2310 information		447961	448000			
Channel 2401 information		448001	448040			
Channel 2402 information		448041	448080			
Channel 2410 information		448361	448400			
Channel 2501 information		448401	448440			
Channel 2502 information		448441	448480			
Channel 2510 information		448761	448800			
Expandable I/O 3		Channel 3001 information	448801	448840		
		Channel 3002 information	448841	448880		
	Channel 3010 information	449161	449200			
	Channel 3101 information	449201	449240			
	Channel 3102 information	449241	449280			
	Channel 3110 information	449561	449600			
	Channel 3201 information	449601	449640			
	Channel 3202 information	449641	449680			
	Channel 3210 information	449961	450000			
	Channel 3301 information	450001	450040			
	Channel 3302 information	450041	450080			
	Channel 3310 information	450361	450400			
	Channel 3401 information	450401	450440			
	Channel 3402 information	450441	450480			
	Channel 3410 information	450761	450800			

Continued on next page

Unit	I/O channel information	Start register	End register	Register type	Remarks	
Expandable I/O 3	Channel 3501 information	450801	450840	16-bit signed integer	High and low limit range, unit, tag name writing not allowed 0 if it does not exist.	
	Channel 3502 information	450841	450880			
	Channel 3510 information	451161	451200			
Expandable I/O 4	Channel 4001 information	451201	451240			
	Channel 4002 information	451241	451280			
	Channel 4010 information	451561	451600			
	Channel 4101 information	451601	451640			
	Channel 4102 information	451641	451680			
	Channel 4110 information	451961	452000			
	Channel 4201 information	452001	452040			
	Channel 4202 information	452041	452080			
	Channel 4210 information	452361	452400			
	Channel 4301 information	452401	452440			
	Channel 4302 information	452441	452480			
	Channel 4310 information	452761	452800			
	Channel 4401 information	452801	452840			
	Channel 4402 information	452841	452880			
	Channel 4410 information	453161	453200			
	Channel 4501 information	453201	453240			
	Channel 4502 information	453241	453280			
	Channel 4510 information	453561	453600			
	Expandable I/O 5	Channel 5001 information	453601	453640		
		Channel 5002 information	453641	453680		
Channel 5010 information		453961	454000			
Channel 5101 information		454001	454040			
Channel 5102 information		454041	454080			
Channel 5110 information		454361	454400			
Channel 5201 information		454401	454440			
Channel 5202 information		454441	454480			
Channel 5210 information		454761	454800			
Channel 5301 information		454801	454840			
Channel 5302 information		454841	454880			
Channel 5310 information		455161	455200			
Channel 5401 information		455201	455240			
Channel 5402 information		455241	455280			
Channel 5410 information		455561	455600			
Channel 5501 information	455601	455640				
Channel 5502 information	455641	455680				
Channel 5510 information	455961	456000				

Continued on next page

#### 4.5 Modbus Function and Register Assignments

Unit	I/O channel information	Start register	End register	Register type	Remarks
Expandable I/O 6	Channel 6001 information	456001	456040	16-bit signed integer	High and low limit range, unit, tag name writing not allowed 0 if it does not exist.
	Channel 6002 information	456041	456080		
	Channel 6010 information	456361	456400		
	Channel 6101 information	456401	456440		
	Channel 6102 information	456441	456480		
	Channel 6110 information	456761	456800		
	Channel 6201 information	456801	456840		
	Channel 6202 information	456841	456880		
	Channel 6210 information	457161	457200		
	Channel 6301 information	457201	457240		
	Channel 6302 information	457241	457280		
	Channel 6310 information	457561	457600		
	Channel 6401 information	457601	457640		
	Channel 6402 information	457641	457680		
	Channel 6410 information	457961	458000		
Channel 6501 information	458001	458040			
Channel 6502 information	458041	458080			
Channel 6510 information	458361	458400			

**Property 10 to 16 (for I/O channel information)**

The relationship between the property number and I/O channel is as follows.

Property number	Unit	Unit number (X)	I/O channel	Remarks
10	GX/GP	0	0001 to 0950	
11	Expandable I/O 1	1	1001 to 1550	
12	Expandable I/O 2	2	2001 to 2550	
13	Expandable I/O 3	3	3001 to 3550	
14	Expandable I/O 4	4	4001 to 4550	
15	Expandable I/O 5	5	5001 to 5550	
16	Expandable I/O 6	6	6001 to 6550	

I/O channel information	Start register	End register	Register type	Remarks
Channel X001 information	440001	440040	16-bit signed integer	X: Unit number Channels X601 to X950 are GX/GP channels only.
Channel X002 information	440041	440080		
Channel X050 information	441961	442000		
Channel X101 information	442001	442040		
Channel X102 information	442041	442080		
Channel X150 information	443961	444000		
Channel X201 information	444001	444040		
Channel X202 information	444041	444080		
Channel X250 information	445961	446000		
Channel X301 information	446001	446040		
Channel X302 information	446041	446080		
Channel X350 information	447961	448000		
Channel X401 information	448001	448040		
Channel X402 information	448041	448080		
Channel X450 information	449961	450000		
Channel X501 information	450001	450040		
Channel X502 information	450041	450080		
Channel X550 information	451961	452000		
Channel X601 information	452001	452040		
Channel X602 information	452041	452080		
Channel X650 information	453961	454000		
Channel X701 information	454001	454040		
Channel X702 information	454041	454080		
Channel X750 information	455961	456000		
Channel X801 information	456001	456040		
Channel X802 information	456041	456080		
Channel X850 information	457961	458000		
Channel X901 information	458001	458040		
Channel X902 information	458041	458080		
Channel X950 information	459961	460000		

## 4.5 Modbus Function and Register Assignments

### Property 20 (for math channel information)

I/O channel information	Start register	End register	Register type	Remarks
Channel A001 information	440001	440040	16-bit signed integer	High and low limit range, unit, tag name writing not allowed 0 if it does not exist.
Channel A002 information	440041	440080		
Channel A200 information	447961	448000		

### Property 30 (for communication channel information)

I/O channel information	Start register	End register	Register type	Remarks
Channel C001 information	440001	440040	16-bit signed integer	High and low limit range, unit, tag name writing not allowed 0 if it does not exist.
Channel C002 information	440041	440080		
Channel C500 information	459961	460000		

### Channel Property Details

Detailed information is stored every 40 registers.

An example for property number 0 and output channel 0001 is shown below.

Item	Start register	End register	Register type	Remarks
High limit range	440001	440002	32-bit signed integer	When the computation type is Off or Delta: The span upper limit is output. When the computation type is Linear scaling or Square root: The scale 100% value is output. When the computation type is log input, pseudo-log input, or linear-log input: 0 is output.
Low limit range	440003	440004		
Decimal Place	440005	440005	16-bit signed integer	When the computation type is Off or Delta: The span decimal place is output. When the computation type is Linear scaling or Square root: The scale decimal place is output. When the computation type is log input, pseudo-log input, or linear-log input: 0 is output.
Unit	440006	440013		
Tag name	440014	440040		UTF-8 character string Up to 6 characters (15 bytes) A terminator is added to the end.
				UTF-8 character string Up to 32 characters (53 bytes) A terminator is added to the end.

# 5.1 Maintenance

## 5.1.1 Periodic Inspection

Check the operation periodically to keep the GX/GP in good working order. Perform the following inspections, and replace worn parts as needed.

- Is the display and storage functioning properly?  
If not, see section 5.2, "Troubleshooting."
- Has the brightness of the LCD backlight deteriorated?  
If replacement is necessary, see section 5.1.5, "Recommended Replacement Periods for Worn Parts."

## 5.1.2 Calibrating AI Modules

To maintain measurement and output accuracy, we recommend that you calibrate AI modules once a year. YOKOGAWA dealers can provide calibration servicing. For details, contact your nearest YOKOGAWA dealer.

### Using a Password

You can use a password to allow only permitted users to perform calibration. This is not available when you are using the advanced security function (/AS option).

- 1 Tap the **MENU** key, **Browse** tab, **Initialize Calibration**, and menu **A/D calibration**. The A/D calibration call-up screen appears.

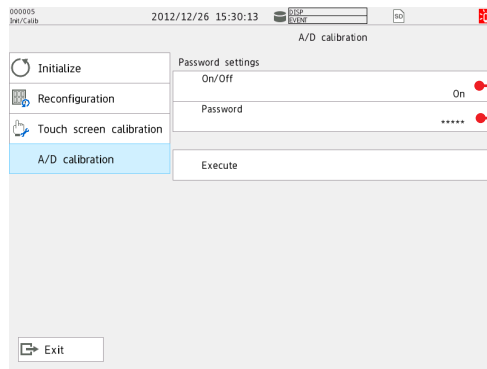

Enable the password (On).  
Set the password.

- 2 Tap **On/Off** under Password settings to select **On**.
- 3 Tap **Password**, and set the password. The password is displayed using asterisks.

From the next time, enter the password to show the A/D calibration call-up screen.

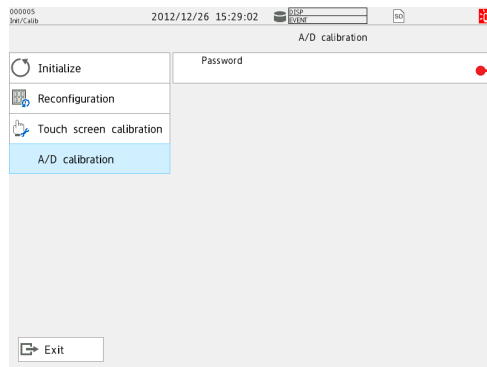

Enter the password.

- 4** Tap **Exit** to exit from the Initialize Calibration screen.

#### Operation complete

#### Note

- Default password: default
- Initialization does not initialize the A/D calibration password.  
If you forget the password, you will not be able to perform A/D calibration. Make sure you do not forget the password.

## Calibrating AI Modules

### Required Instruments

To calibrate the AI modules, you need calibration instruments with the following accuracy and resolution.

### Recommended Instruments

- DC voltage standard: DC Voltage/Current Standard  
Must meet the following specifications (M/9100 by FLUKE or equivalent)  
Voltage output range: 20 mV to 100 V  
Output accuracy of output range:  $\pm(0.01\%+1 \mu\text{V})$  or better  
  
Must meet the following specifications (for mA modules, Yokogawa Meters & Instruments GS200 or equivalent)  
Current output range: 0 mA to 20 mA  
Setting output accuracy:  $\pm(0.03\%$  of setting + 5  $\mu\text{A})$  or better
  - Resistance standard: Must meet the following specifications (ADR3204 by Alpha Electronics or equivalent)  
Resistance setting range (resolution):  
0.2 to 1999  $\Omega$  (0.001  $\Omega$ ), 0.2 to 19999  $\Omega$  (0.01  $\Omega$ )  
Resistance accuracy of the resistance setting range:  
 $\pm (0.01\%$  of + 2 m $\Omega$  ) or better
  - Digital Multimeter: Must meet the following specifications (for mA modules)  
Agilent 3458A or equivalent  
Current measurement range: 100 mA  
Measurement accuracy: 35 ppm of reading + 5 ppm of range
  - 0°C standard temperature device: ZC-114/ZA-10 by Coper Electronics or equivalent  
Main specifications  
Standard temperature stability accuracy:  $\pm 0.05^\circ\text{C}$
- For information on purchasing these calibration instruments, contact your nearest YOKOGAWA dealer.

### Calibration Procedure

- 1** Wire the GX/GP and the calibration instruments as shown in the following figure, and adequately warm up the instruments (the warm-up time of the GX/GP is at least 30 minutes).  
Note: The wiring diagram is an example for the universal, 4-wire RTD/resistance type. For details on wiring, see "Installation and Wiring" in the First Step Guide (IM 04L51B01-02EN).
- 2** Check that the operating environment such as ambient temperature and humidity is within the standard operating conditions (see "General Specifications").
- 3** Apply appropriate input signals corresponding to 0, 50, and 100% of the input range and calculate the errors from the readings. For current (mA) modules, the error is determined from the difference between the measured value and the digital multimeter value. For the high-speed universal type, each channel needs to be calibrated. If the error does not fall within the accuracy range of the specifications, servicing is required. Contact your nearest YOKOGAWA dealer.

You can also perform the A/D calibration and adjust the GX/GP within the accuracy specifications. Follow the instructions in section 5.1.3, "Performing A/D Calibration and Adjusting the Input Accuracy."



**Note**

For thermocouple inputs, you must measure the temperature of the input terminal and apply a voltage taking into account the reference junction temperature.

**DC Voltage Measurement**

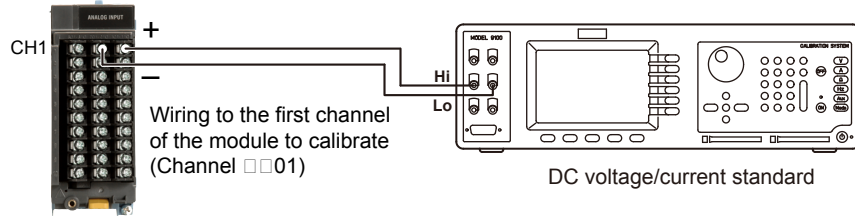

**Temperature or Resistance Measurement Using an RTD**

**Three-wire system**

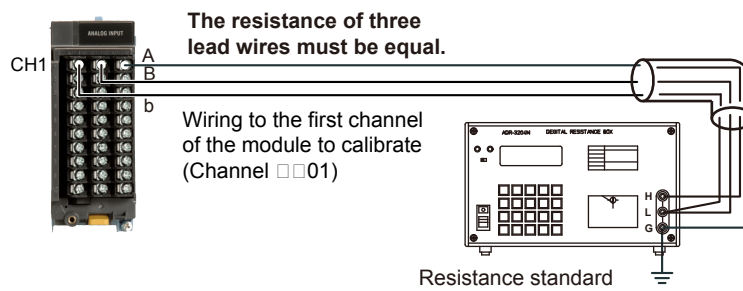

**Four-wire system/resistance**

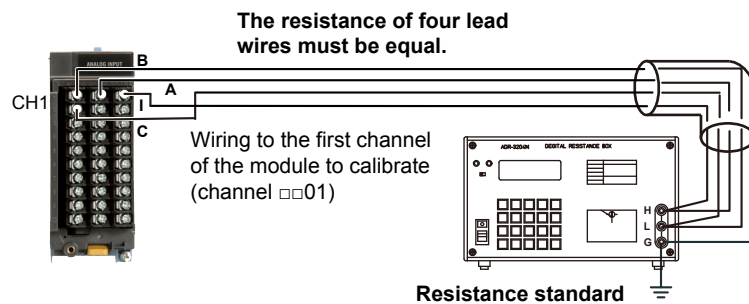

**Current (mA) Input**

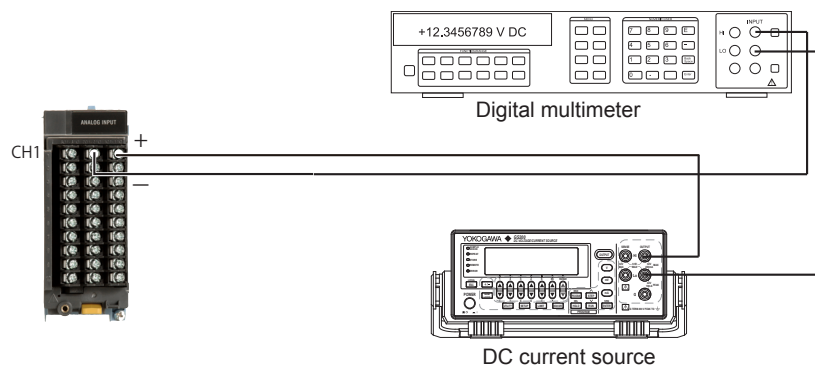

### Temperature Measurement When Using a Thermocouple

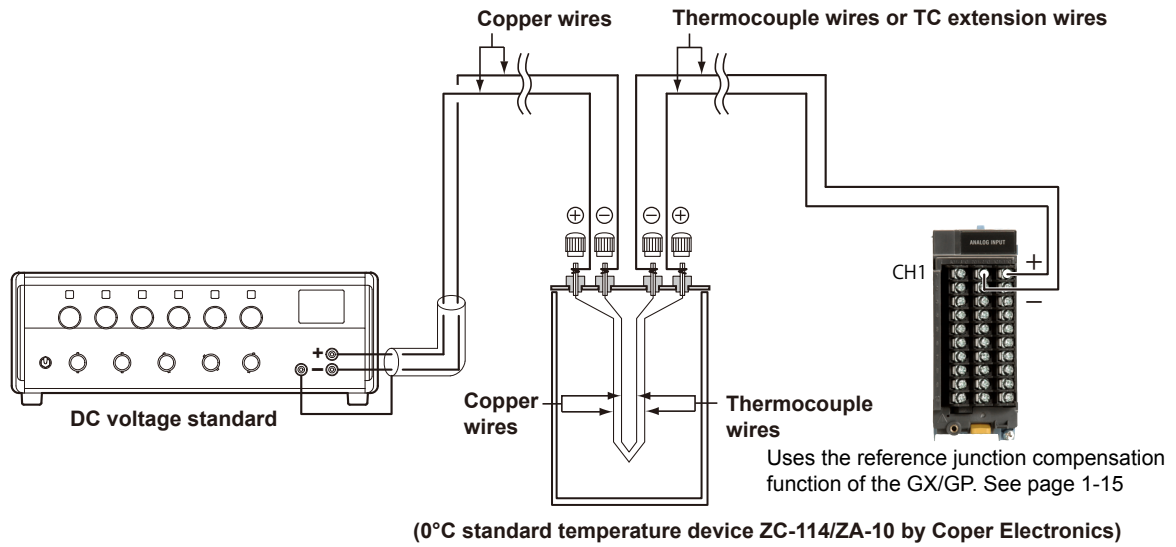

#### RJC of TC Input

As the measurement terminal of the GX/GP is generally at room temperature, the actual output of the thermocouple is different from the values given on the thermoelectromotive force table based on 0°C. The GX/GP performs compensation by measuring the temperature at the input terminal and adding the corresponding thermoelectromotive force to the actual output of the thermocouple. Therefore, when the measurement terminal is shorted (equivalent to the case when the detector tip is 0°C), the measured value indicates the temperature of the input terminal.

When calibrating the GX/GP, this compensation voltage (thermoelectromotive force of 0°C reference corresponding to the input terminal temperature) must be subtracted from the output of the standard generator before application. As shown in the figure, by using the 0°C standard temperature device to compensate the reference junction at 0°C, you can input the thermoelectromotive force of 0°C reference from the DC voltage standard and perform the calibration.

## Calibrating AO Modules

### Required Instruments

To calibrate AO modules, you need calibration instruments with the following specifications and accuracy.

### Recommended Instruments

- Resistance standard : Resistance value: 600  $\Omega$  or less  
Accuracy:  $\pm 0.01\%$  or more  
Allowable power: 0.25 W or higher  
Temperature coefficient: 5ppm/ $^{\circ}\text{C}$  or less
- Digital Multimeter : Accuracy:  $\pm 0.01\%$  or more

For information on purchasing these calibration instruments, contact the YOKOGAWA dealer that you purchased the GX/GP from.

### Calibration Procedure

- 1 Wire the GX/GP and the calibration instruments as shown in the following figure, and adequately warm up the instruments (the warm-up time of the GX/GP is at least 30 minutes).
- 2 Check that the operating environment such as ambient temperature and humidity is within the standard operating conditions (see “General Specifications”).
- 3 Set the range type to **Manual** and the range to **4-20mA**.
- 4 Manually output 4 mA and 20 mA, and determine the error from the measured values. For measurements using voltage, the error is determined from the difference between the measured value and the digital multimeter value. If the error does not fall within the accuracy range of the specifications, servicing is required. Contact your nearest YOKOGAWA dealer.

#### Wiring for voltage measurement

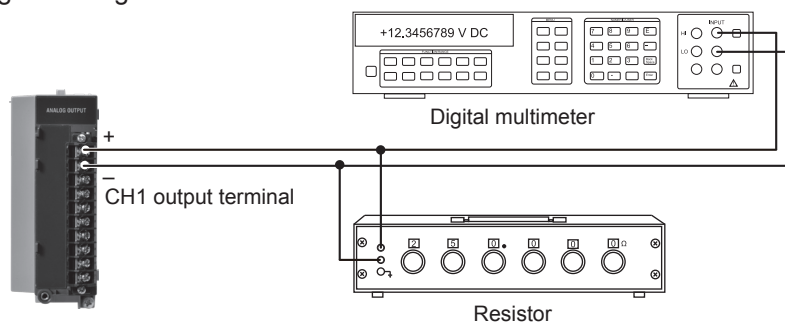

#### Wiring for current measurement

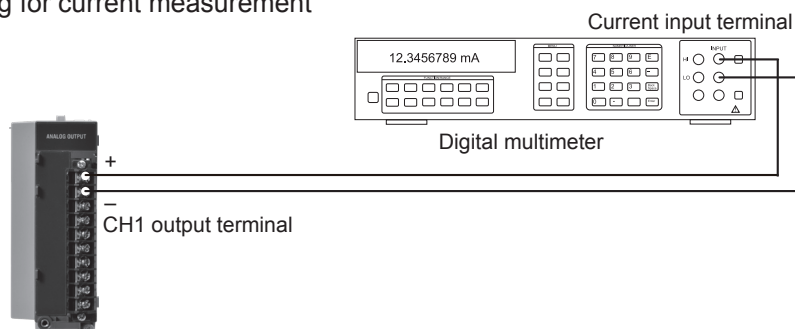

## Calibrating PID Modules

For input calibration, refer to the AI module calibration. For output calibration, refer to the AO module calibration.

For details on wiring, see “Installation and Wiring” in the First Step Guide (IM 04L51B01-02EN).

### 5.1.3 Performing A/D Calibration and Adjusting the Input Accuracy of AI Modules

#### Preparing the Instruments

- 1 Wire the GX/GP and the calibration instruments as shown in the following figure, and adequately warm up the instruments (the warm-up time of the GX/GP is at least 30 minutes).  
For details on wiring, see "Installation and Wiring" in the First Step Guide (IM 04L51B01-02EN).
- 2 Check that the operating environment such as ambient temperature and humidity is within the standard operating conditions (see "General Specifications").

#### Operation complete

#### Universal, Electromagnetic Relay, Low Withstand Voltage Relay, Current (mA), 4-wire RTD/Resistance, High Withstand Voltage Type

##### Wiring for DC voltage range

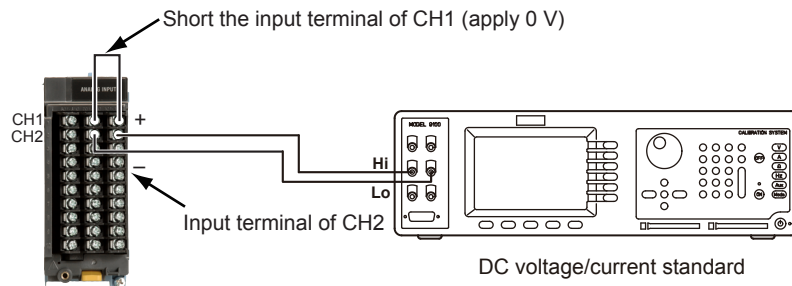

##### Wiring for RTD range

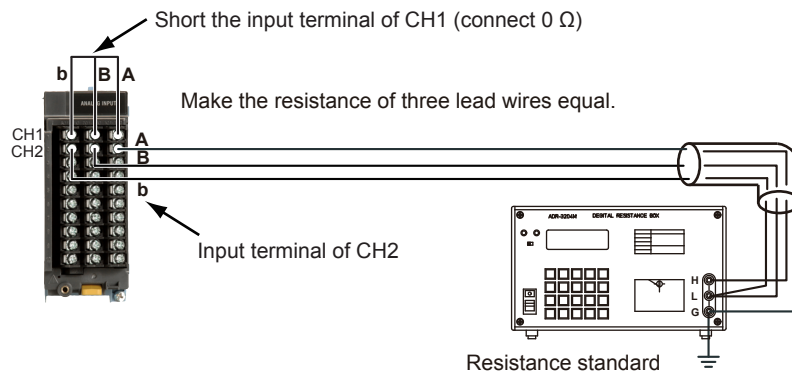

##### Wiring Current (mA) Input Modules

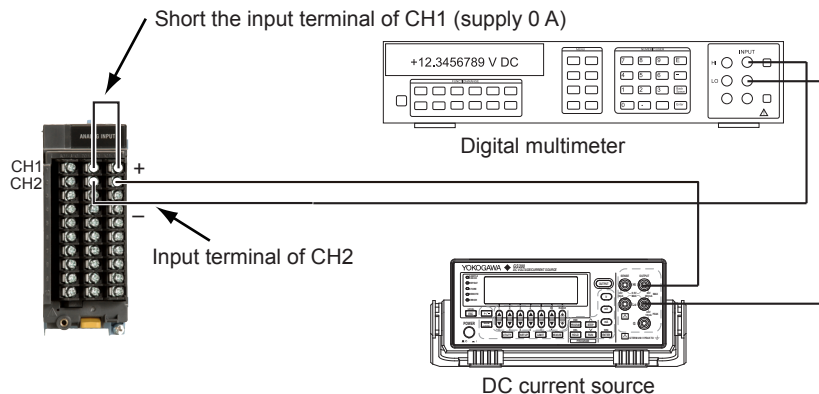

### High-speed Universal Type

For the high-speed universal type, each channel needs to be calibrated.

#### Wiring for DC voltage range

Wiring for zero-point calibration

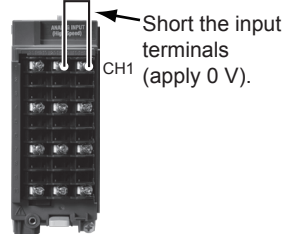

Wiring for full-scale calibration of a range

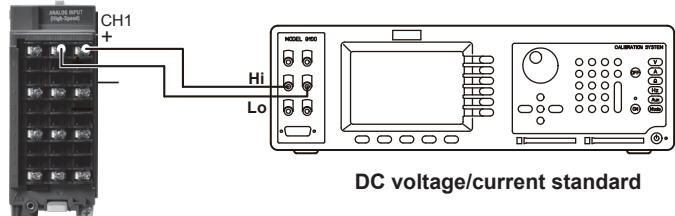

#### Wiring for RTD range

Wiring for zero-point calibration

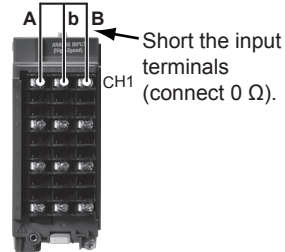

Wiring for full-scale calibration of a range

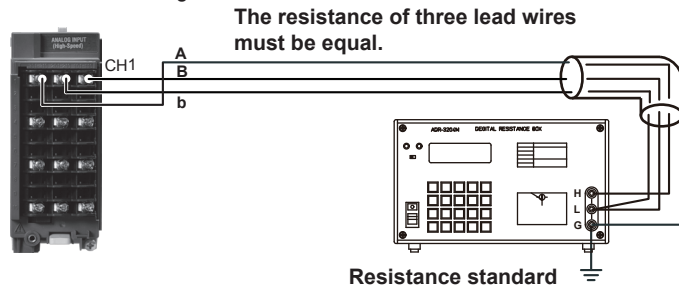

#### 4-wire RTD/Resistance Type

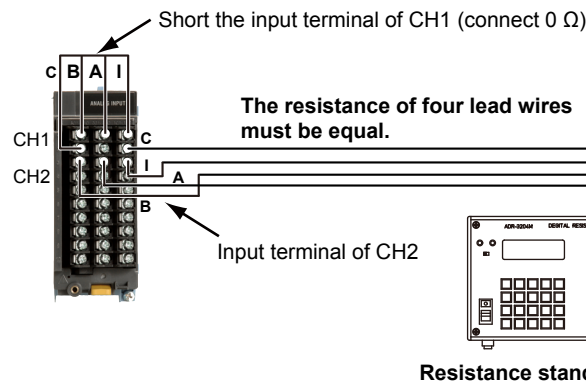

**Performing A/D Calibration and Adjusting the Input Accuracy**

For details on switching to the A/D calibration mode when you are using the advanced security function (/AS option), see section 2.3.1, “Logging In,” in the Advanced Security Function (/AS) User’s Manual (IM 04L51B01-05EN).

**Universal, Electromagnetic Relay, Low Withstand Voltage Relay, Current (mA), 4-wire RTD/Resistance, High Withstand Voltage Type**

- 1 Tap the **MENU** key, **Browse** tab, **Initialize Calibration**, and menu **A/D calibration**. The A/D calibration call-up screen appears.
- 2 Tap **Execute**. A screen appears for you to confirm the switch to A/D calibration mode.
- 3 Tap **OK**. The GX/GP restarts and enters A/D calibration mode.
- 4 Select the unit in which the module to calibrate is installed, and tap **Next**. The module selection screen appears.
- 5 Select the module to calibrate, and tap **Next**.

The screenshot shows the 'A/D calibration mode' screen. At the top, it displays 'User001' and 'Unit:Main -> Slot:0 GX90MA-10-U2'. Below this is a table with columns 'Range', 'Value1', 'Value2', and 'Execute'. The table lists various voltage and resistance ranges. A red dot on the 'Execute' button of the first row is labeled 'Calibrate the selected range.' Below the table are four buttons: 'Exit', 'Back', 'Reset', and 'Write'. Red lines connect these buttons to text labels: 'Exit' is labeled 'Exits from calibration mode', 'Back' is labeled 'Returns to the module selection screen', 'Reset' is labeled 'Returns the calibration values to their factory defaults', and 'Write' is labeled 'Saves calibration values'.

\* This is a screen example for the universal type.

- 6 For each calibration range, apply the reference values indicated in the table below.

**Universal, Electromagnetic Relay, Low Withstand Voltage Relay, Current (mA), High Withstand Voltage Type**

Range	CH1	CH2
20 mV	0 mV (Short circuit)	20 mV
60 mV	0 mV (Short circuit)	60 mV
200 mV	0 mV (Short circuit)	200 mV
1 V	0 V (Short circuit)	1 V
2 V	0 V (Short circuit)	2 V
6 V	0 V (Short circuit)	6 V
20 V	0 V (Short circuit)	20 V
50 V	0 V (Short circuit)	50 V
Pt100-H <sup>1</sup>	0 Ω (Short circuit)	160 Ω
Pt100 <sup>1</sup>	0 Ω (Short circuit)	400 Ω
20mA <sup>2</sup>	0 A (short)	20mA

- 1 Range calibration of RTDs is not applicable to the electromagnetic relay type (Type suffix code -T1) or low withstand voltage relay type (Type suffix code -L1), high withstand voltage (Type suffix code -V1) analog input module.
- 2 For only the analog input modules of the current input type (Type suffix code -C1)

**4-wire RTD/Resistance Type**

Range	CH1	CH2
20 ohm	0 $\Omega$ (short)	20 $\Omega$
Pt100-H	0 $\Omega$ (short)	160 $\Omega$
Pt100	0 $\Omega$ (short)	400 $\Omega$
2000 ohm	0 $\Omega$ (short)	2000 $\Omega$
Pt1000	0 $\Omega$ (short)	4000 $\Omega$

- 7** Tap **Execute** for the range you want to calibrate.  
While calibration is in progress, a message indicating this appears. When the calibration is complete, the message "Execution is complete" and the calibration value appear.
- 8** Repeat step 5 for every range.
- 9** When all the ranges have been calibrated, tap **Write**.  
The calibration values will be saved.  
  
To reset the A/D calibration values to their factory defaults, tap **Reset**.  
You do not have to tap **Write**.
- 10** To calibrate a different module, wire the module to calibrate, tap **Back**, and perform steps 4 to 7.
- 11** Tap **Exit**. A confirmation screen is displayed. Tap **OK** to exist calibration mode.

Operation complete

**High-speed Universal Type**

- 1** Tap the **MENU** key, **Browse** tab, **Init/Calib**, and menu **A/D calibration**.  
The A/D calibration call-up screen appears.
- 2** Tap **Execute**.  
A screen appears for you to confirm the switch to A/D calibration mode.
- 3** Tap **OK**.  
The GX/GP restarts in A/D calibration mode.
- 4** Select the unit in which the module to calibrate is installed, and tap **Next**.  
The module selection screen appears.
- 5** Select the module you want to calibrate, and tap **Next**.  
The channel selection screen appears.

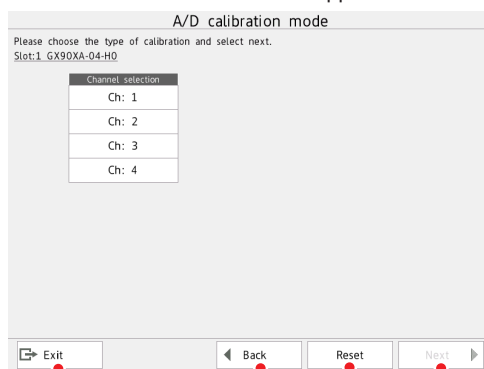

- Exit: Exits from calibration mode
- Back: Returns to the module selection screen
- Reset: Returns the calibration values to their factory defaults
- Next: Go to calibration screen

- 6** Select the channel you want to calibrate, and tap **Next**.

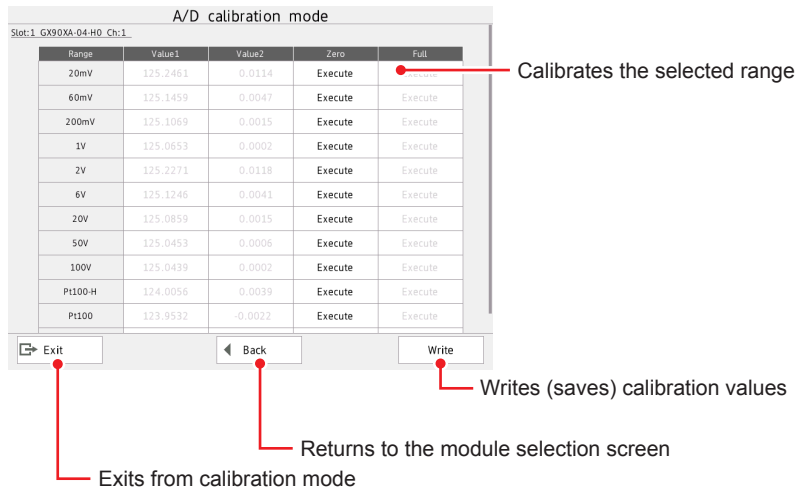

- 7** Short the input terminals of the channel to you want to calibrate.
- 8** Tap **Execute** under Zero for the range you want to calibrate. When calibration is complete, the message “Execution is complete” will appear.
- 9** Wire the calibration instrument to the input terminals of the channel you want to calibrate.
- 10** Enter the reference value of the range to be calibrated according to the following table, and tap **Execute** under Full. When the calibration is complete, the message “Execution is complete” and the calibration value appear.

Range	Reference value
20 mV	20 mV
60 mV	60 mV
200 mV	200 mV
1 V	1 V
2 V	2 V
6 V	6 V
20 V	20 V
50 V	50 V
100 V	100 V
Pt100-H	160 Ω
Pt100	500 Ω
Cu10 GE	50 Ω

- 11** For each range you want to calibrate, repeat steps 7 to 10.
- 12** When all the ranges have been calibrated, tap **Save**. The calibration values will be saved.
- 13** To calibrate a different channel, tap **Back**, and perform steps 6 to 12. To calibrate a different module, tap **Back**, and carry out the steps from unit selection (step 4) or module selection (step 5).
- 14** Tapping **Close** displays a confirmation screen. Tap **OK** to end calibration mode.

Operation complete



**Note**

Do not perform any other operations (especially turning the GX/GP off) during calibration.  
The GX/GP may malfunction.

## 5.1.4 Calibrating the D/A of AO Modules and Adjusting the Output Accuracy

### Required Instruments

To adjust AO modules, you need calibration instruments with the following specifications and accuracy.

- Resistance standard : Resistance value: 600  $\Omega$  or less  
Accuracy:  $\pm 0.01\%$  or more  
Allowable power: 0.25 W or higher  
Temperature coefficient: 5ppm/ $^{\circ}\text{C}$  or less
- Digital Multimeter : Accuracy:  $\pm 0.01\%$  or more

For information on purchasing these calibration instruments, contact the YOKOGAWA dealer that you purchased the GX/GP from.

### Preparing the Instruments

- 1 Wire the channel of the AO module to be calibrated and the calibration instruments as shown in the following figure, and adequately warm up the instruments (the warm-up time of the GX/GP is at least 30 minutes).
- 2 Check that the operating environment such as ambient temperature and humidity is within the standard operating conditions. (See the general specifications.)

#### Operation complete

#### Wiring for voltage measurement

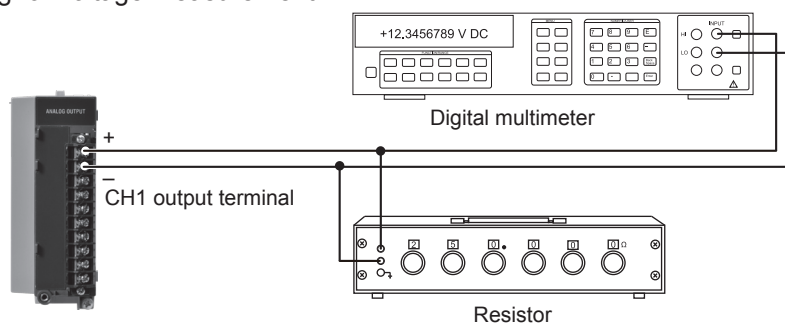

#### Wiring for current measurement

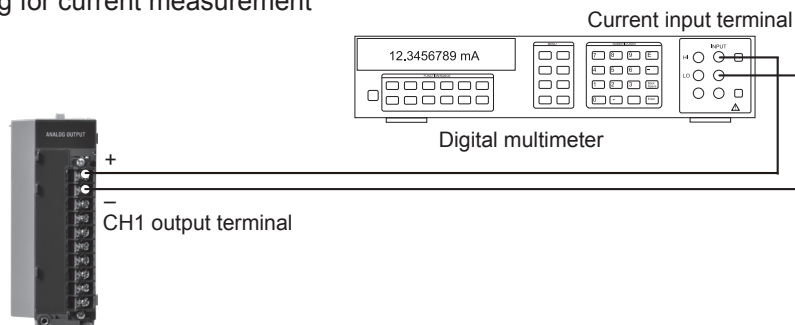

### Calibrating the AO Module and Adjusting the Output Accuracy

For details on switching to the A/D calibration mode when you are using the advanced security function (/AS option), see section 2.3.1, "Logging In," in the GX/GP Advanced Security Manual.

**Note**

Do not perform any other operations (especially turning the GX/GP off) while calibrating the AO module.  
The GX/GP may malfunction.

- 1 Tap the **MENU** key, **Browse** tab, **Init/Calib**, and menu **A/D calibration**.  
The A/D calibration call-up screen appears.
- 2 Tap **Execute**.  
A screen appears for you to confirm the switch to A/D calibration mode.
- 3 Tap **OK**.  
The GX/GP restarts in A/D calibration mode.
- 4 Select the unit in which the AO module to calibrate is installed, and tap **Next**.  
The module selection screen appears.  
If the AO module does not appear, the module has not been detected.
- 5 Select the module you want to calibrate, and tap **Next**.  
The AO module calibration screen appears.

The screenshot shows the 'A/D calibration mode' screen for Slot:2 GX907A-04-C1. It contains a table with the following data:

Channel	Range	Count	Output
1	4mA	8629	START
	20mA	42184	START
2	4mA	8640	START
	20mA	42251	START
3	4mA	8618	START
	20mA	42188	START
4	4mA	8637	START
	20mA	42222	START

Annotations in the image:

- Exit**: Exits from calibration mode
- Back**: Returns to the module selection screen
- Reset**: Returns the calibration values to their factory defaults
- Write**: Saves calibration values
- START**: Calibrates the selected range (output start/output stop)
- START**: Writes calibration values

- 6 Tap **START** for the 4 mA range of the channel to be calibrated.  
The GX/GP outputs at the current calibration value. During output, the button changes to STOP.  
Output can be started simultaneously on multiple channels of the same module.
- 7 Tap the calibration value (Count).  
The calibration value input screen appears.

The screenshot shows the calibration value input screen. At the top, it displays 'Available range 8286/ 9288' and the current value '8629'. Below is a numeric keypad with digits 0-9, a decimal point, and an 'Enter' key. At the bottom, there are 'Cancel', 'Back', 'Reset', and 'OK' buttons. On the right side, there are 'BS', 'DEL', and 'START' buttons for each channel.

- 8** Set the calibration value, and tap **OK**.  
The specified calibration value is written, and the corresponding value is output.  
Repeat the procedure until the multimeter reading falls within the values corresponding to the output accuracy.

Example of the accuracy range for voltage measurement (voltage drop method, resistance: 250  $\Omega$ )

Range	Output Accuracy Range	Digital Multimeter Indication Range (Resistance: 250 $\Omega$ )
4 mA	3.98 to 4.02 mA	995 to 1005 mV
20 mA	19.98 to 20.02 mA	4995 to 5005 mV

- 9** Perform a procedure similar to steps 6 to 8 to calibrate the 20 mA range.
- 10** To calibrate another channel, wire the channel you want to calibrate, and perform steps 6 to 9.
- 11** When all the channels have been calibrated, tap **Save**.  
The calibration values are saved.  
  
To reset the calibration values to their factory defaults, tap **Reset**.  
You do not have to tap **Save**.
- 12** To calibrate a different module, tap **Back**, and carry out the steps from unit selection (step 4) or module selection (step 5).
- 13** Tapping **Close** displays a confirmation screen. Tap **OK** to end A/D calibration mode.

Operation complete

## 5.1.5 Calibrating the I/O of PID Modules and Adjusting the I/O Accuracy

### Calibrating the Input

- 1** Tap the **MENU** key, **Browse** tab, **Init/Calib**, and menu **A/D calibration**.  
The A/D calibration call-up screen appears.
- 2** Tap **Execute**.  
A screen appears for you to confirm the switch to A/D calibration mode.
- 3** Tap **OK**.  
The GX/GP restarts in A/D calibration mode.
- 4** Select the unit in which the module to calibrate is installed, and tap **Next**.  
The module selection screen appears.

- 5** Select the module you want to calibrate, and tap **Next**.  
An I/O selection screen appears.

A/D calibration mode  
Please choose the type of calibration and select next.  
Slot:4 GX90UT-02-11

Input/Output selection

- Input calibration
- Output calibration

Exit Back Reset Next

- Exit: Exits from calibration mode
- Back: Returns to the module selection screen
- Reset: Returns the calibration values to their factory defaults
- Next: Go to channel selection

- 6** Select **Input calibration**, and tap **Next**.  
The channel selection screen appears.

A/D calibration mode  
Please choose the type of calibration and select next.  
Slot:4 GX90UT-02-11

Channel selection

- Ch: 1
- Ch: 2

Exit Back Next

- 7** Select the channel you want to calibrate, and tap **Next**.

A/D calibration mode  
Slot:9 GX90UT-02-11 Ch:1

Range	Value1	Value2	Zero	Full
20mV	125.2754	0.0179	Execute	Execute
60mV	125.1622	0.0071	Execute	Execute
200mV	125.0687	0.0021	Execute	Execute
1V	125.0342	0.0001	Execute	Execute
2V	125.1974	0.0259	Execute	Execute
6V	125.0804	0.0100	Execute	Execute
20V	124.9899	0.0030	Execute	Execute
50V	124.9361	0.0014	Execute	Execute
Pt100-H	124.0211	0.0023	Execute	Execute
Pt100	123.9676	0.0006	Execute	Execute
Cu10GE	124.0328	0.0069	Execute	Execute

Exit Back Write

- Exit: Exits from calibration mode
- Back: Returns to the module selection screen
- Write: Writes (saves) calibration values
- Full (Execute): Calibrates the selected range

- 8** Short the input terminals of the channel to you want to calibrate.
- 9** Tap **Execute** under Zero for the range you want to calibrate.  
When calibration is complete, the message "Execution is complete" will appear.
- 10** Wire the calibration instrument to the input terminals of the channel you want to calibrate.
- 11** Enter the reference value of the range to be calibrated according to the following table, and tap **Execute** under Full.  
When calibration is complete, the message "Execution is complete" will appear.

Range	Reference value
20 mV	20 mV
60 mV	60 mV
200 mV	200 mV
1 V	1 V
2 V	2 V
6 V	6 V
20 V	20 V
50 V	50 V
Pt100-H	160 $\Omega$
Pt100	500 $\Omega$
Cu10 GE	50 $\Omega$

- 12** For each range you want to calibrate, repeat steps 8 to 11.
- 13** When all the ranges have been calibrated, tap **Save**.  
The calibration values will be saved.
- 14** To calibrate a different channel, tap **Back**, and perform steps 7 to 13.  
To calibrate a different module, tap **Back**, and carry out the steps from unit selection (step 4) or module selection (step 5).
- 15** Tapping **Close** displays a confirmation screen. Tap **OK** to end calibration mode.
- Operation complete

**Output Calibration**

- 1 Tap the **MENU** key, **Browse** tab, **Init/Calib**, and menu **A/D calibration**.  
The A/D calibration call-up screen appears.
- 2 Tap **Execute**.  
A screen appears for you to confirm the switch to A/D calibration mode.
- 3 Tap **OK**.  
The GX/GP restarts in A/D calibration mode.
- 4 Select the unit in which the module to calibrate is installed, and tap **Next**.  
The module selection screen appears.
- 5 Select the module you want to calibrate, and tap **Next**.  
An I/O selection screen appears.

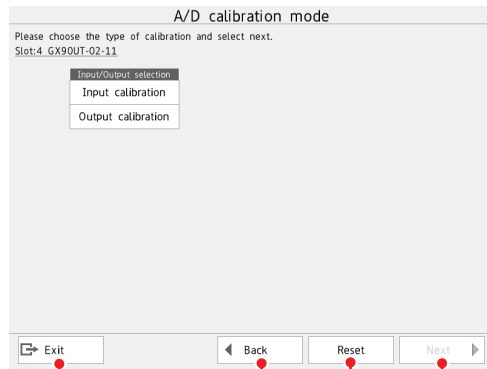

- Exit — Exits from calibration mode
- Back — Returns to the module selection screen
- Reset — Returns the calibration values to their factory defaults
- Next — Go to channel selection

To reset the calibration values to their factory defaults, tap **Reset**.  
You do not have to tap **Save**.

- 6 Select **Output calibration**, and tap **Next**.

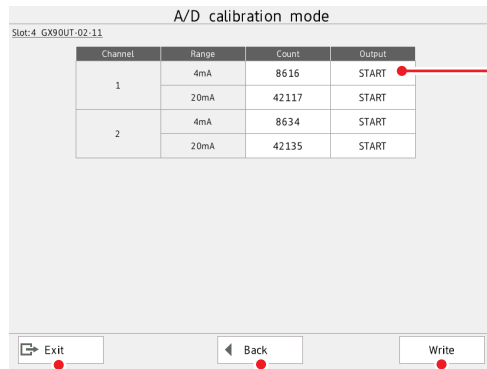

- START — Calibrates the selected range
- Exit — Exits from calibration mode
- Back — Returns to the module selection screen
- Write — Writes (saves) calibration values

- 7 Tap **START** for the 4 mA range of the channel to be calibrated.  
The GX/GP outputs at the current calibration value. During output, the button changes to STOP.  
Output can be started simultaneously on multiple channels.

- 8** Tap the calibration value (Count).  
The calibration value input screen appears.
- 9** Set the calibration value, and tap **OK**.  
The specified calibration value is written, and the corresponding value is output.  
Repeat the procedure until the multimeter reading falls within the values corresponding to the output accuracy.  
Tapping **STOP** under Output to stops the output. The display changes to START.

Example of the accuracy range for voltage measurement (voltage drop method, resistance: 250  $\Omega$ )

Range	Output Accuracy Range	Digital Multimeter Indication Range (Resistance: 250 $\Omega$ )
4 mA	3.98 to 4.02 mA	995 to 1005 mV
20 mA	19.98 to 20.02 mA	4995 to 5005 mV

- 11** Perform a procedure similar to steps 7 to 9 to calibrate the 20 mA range.
- 12** To calibrate another channel, wire the channel you want to calibrate, and perform steps 7 to 11.
- 13** When all the channels have been calibrated, tap **Save**.  
The calibration values are saved.
- 14** To calibrate a different module, tap **Back**, and carry out the steps from unit selection (step 4) or module selection (step 5).
- 15** Tapping **Close** displays a confirmation screen. Tap **OK** to end A/D calibration mode.

Operation complete

## 5.1.6 Adjusting and Checking the Touch Screen

### Path

GX/GP: **MENU** key > **Browse** tab > **Initialize Calibration** > menu **Touch screen calibration**

### Procedure

#### Adjusting and Checking

- 1 Tap **Calibration + Confirmation**.
- 2 Follow the instruction on the screen, and touch the crosshair with the supplied stylus pen or the tip of a pen cap that is not sharp.

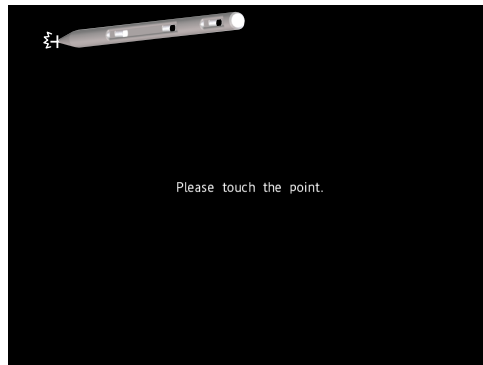

- 3 Follow the instruction on the screen, and check the adjustment result.



- 4 If a message appears for confirming the saving of the adjustment result, tap **OK**. The adjustment results are saved.

If you do not want to save the results, tap **Cancel**.

#### Operation complete

#### **Note**

When you are checking the touch screen adjustment, if you touch a point outside the adjustment area three times, the screen returns to the normal screen. In this case, the adjustment values are not saved, so please adjust again.

#### Checking

- 1 Tap **Confirmation**.
- 2 Follow the instruction on the screen, and touch the crosshair with the supplied stylus pen or the tip of a pen cap that is not sharp.

#### Operation complete



### 5.1.7 Recommended Replacement Periods for Worn Parts

To ensure that this instrument operates reliably and correctly for a long time, we recommend that you carry out preventative maintenance by periodically replacing its parts. As you continue to perform this preventative maintenance over time, the parts that need to be replaced may change. Be sure to check with your nearest YOKOGAWA dealer for information on part replacement.

The recommended replacement periods for parts that wear down (parts that have a service life) are shown in the following table.

The replacement periods listed here have been calculated under the assumption that the GX/GP is used under standard operating conditions. Use these values as a guideline when you determine the replacement periods of the parts of your GX/GP based on its actual usage conditions. Parts must be replaced by qualified YOKOGAWA technicians or technicians specified by YOKOGAWA, so contact your YOKOGAWA dealer when part replacement is necessary.

Item	Replacement Period	Model	Name	Part No.	Quantity	Note
LCD	5 years	GX20	Bezel Assy	B8740BA	1	Not /D5/UH
				B8740BX	1	/D5 (not /UH)
				B8740GA	1	/UH (not /D5)
				B8740GX	1	/D5/UH
		GP20		B8740KA	1	Not /D5/UH
				B8740KX	1	/D5 (not /UH)
				B8740LW	1	/UH (not /D5)
				B8740LX	1	/D5/UH
		GX10		B8741BA	1	Not /UH
				B8741GA	1	/UH
		GP10		B8741JA	1	/UH
				B8741KA	1	Not /UH
Battery	10 years	GX20/GP20 GX10/GP10	Battery Assembly	B8800ZK	1	
Dust and water protection packing	5 years	GX20	MEDIA	B8740BS	1	
		GX10	PACKING	B8741BS	1	
		GX20	PACKING	B8706FY	1	For bezel
		GX10		B8705FY	1	
Aluminum electrolytic capacitor	5 years <sup>1</sup>	GX20/GP20	Standard power supply	B8740DP	—	
				GX20	24 VDC/AC power supply	B8740EP
		GX10/GP10			Standard power supply	B8741DP
				GX10	24 VDC/AC power supply	B8741EP
		GX60			Screw terminal type	B8741HK
				GP10	Inlet type	B8741HH
		12 VDC power supply			B8741EM	

<sup>1</sup> Replacement period when the GX/GP is used at the upper limit of the normal operating temperature (50°C)

The replacement period for aluminum electrolytic capacitors varies depending on the operating temperature and the GX/GP specifications. When the operating temperature is 30°C, the replacement period may be 10 years or more.

#### Note

- The replacement period of the LCD indicates the point in time when the LCD brightness is half of its initial value. The brighter that you set the LCD, the shorter its replacement period becomes. The decrease in the LCD brightness varies depending on the usage conditions, and the judgment of the LCD's brightness is subjective. Keep these points in mind when you determine the actual replacement period of the LCD.
- With the passage of time, the LCD may become tinged red or yellow.  
The brighter that you set the LCD, the faster it will discolor. We recommended using the backlight saver function to slow the progress of such discoloration.

**Module**

Electromagnetic relay type modules make measurements by switching mechanical contact relays on and off. To ensure that the modules continue to operate reliably and correctly, replace them periodically as shown below.

Module	Model	Measurement condition	Replacement period	Note
Analog input module (electromagnetic relay type)	GX90XA-10-T1N-3N	Continuous use at measurement interval 1 s	1 year	
		Continuous use at measurement interval 2 s	2 years	
		Continuous use at measurement interval 5 s	5 years	

## 5.1.8 Updating the Firmware (Release number 2 and later)

This section explains how to update the firmware of the Web application, I/O module, and I/O expansion module (expansion module). Updating is performed in update mode. You need to place the new files in the SD memory card in advance. You cannot update while recording or math is in progress. The communication function also stops.

You can download firmware from the following URL.

[www.smartdacplus.com/software/en/](http://www.smartdacplus.com/software/en/)

### Data Files Applicable for Updating

Target	Description
Web application	Web application
I/O expansion module	I/O expansion module firmware
I/O module (AI/DI/DO/DIO)	I/O module firmware
Pulse input module	Pulse input module firmware
AO module <sup>1</sup>	AO module firmware
High-speed AI module <sup>1</sup>	High-speed AI module firmware
4-wire RTD module <sup>1</sup>	4-wire RTD module firmware
PID control module <sup>1</sup>	PID control module firmware

<sup>1</sup> Release number 4 and later

### Switching to Update Mode

#### Path

GX/GP: **MENU** key > **Browse** tab > **Init/Calib** > menu **Update**

#### Procedure

- 1 Tap **Execute**.  
A screen appears for you to confirm the switch to update mode.
- 2 Tap **OK**.  
The GX/GP restarts and switches to update mode.

Operation complete

### Updating the Web Application

#### Path

GX/GP: **Main Unit** > **Web application**

#### Description

#### Version

Setup Item	Selectable Range or Options	Default Value
Current	—	—
After update	—	—

#### Current

Displays the current version.

#### After update

Displays the version after updating.

**Procedure**

- 1** Tap **Execute**.  
A confirmation screen is displayed.
- 2** Tap **OK**.  
The Web application is updated.
- 3** Tap **Exit**.  
A confirmation screen is displayed.
- 4** Tap **Yes**.  
The GX/GP exits from the update screen and restarts.

[Operation complete](#)

**Updating Modules****Collectively Updating****Path**

GX/GP: **Module** > Batch update **All modules**

**Description****Version after update**

Setup Item	Selectable Range or Options	Default Value
I/O expansion module	—	—
I/O module (AI/DI/DO/DIO)	—	—
Pulse input module	—	—
AO module	—	—
High-speed AI module	—	—
4-wire RTD module	—	—
PID control module	—	—

**I/O Expansion Module**

Displays the I/O expansion module version after updating.

**I/O module (AI/DI/DO/DIO)**

Displays the I/O module version after updating.

**Pulse input Module**

Displays the pulse input module version after updating.

**AO Module**

Displays the AO module version after updating.

**High-speed AI Module**

Displays the high-speed AI module version after updating.

**4-wire RTD Module**

Displays the 4-wire RTD module version after updating.

**PID control Module**

Displays the PID control module version after updating.

**Procedure**

- 1** Tap **Execute**.  
A confirmation screen is displayed.
- 2** Tap **OK**.  
The module firmware is updated.
- 3** Tap **Exit**.  
A confirmation screen is displayed.
- 4** Tap **Yes**.  
The GX/GP exits from the update screen and restarts.

Operation complete

**Updating Individually****Path**

GX/GP: **Module** > Individual update **Main Unit** or **Unit1 to 6** > **Slot0 to 9** <sup>1</sup>

<sup>1</sup> GX/GP: Slots 0 to 9

Expandable I/O: Slots 0 to 5

**Description****Version**

Setup Item	Selectable Range or Options	Default Value
Current	—	*
After update	—	—

**Current**

Displays the current version of the selected module.

**After update**

Displays the version of the selected module after updating.

**Procedure**

- 1** Tap **Execute**.  
A confirmation screen is displayed.
- 2** Tap **OK**.  
The firmware of the selected module is updated.
- 3** Tap **Exit**.  
A confirmation screen is displayed.
- 4** Tap **Yes**.  
The GX/GP exits from the update screen and restarts.

Operation complete

## 5.2 Troubleshooting

### 5.2.1 Messages

Error codes and messages may appear on the screen while you are using the GX/GP. A list of the possible error codes and messages are given in the table below. Communication error codes and messages are also listed.  
 "\*\*\*\*\* " is Error.

### Errors Related to Parameter Settings

#### • Setting Errors

Code	Message	Description, Corrective Action, Ref. Section
1	Incorrect date or time setting.	Enter a correct value.
2	The setting of the parameter is wrong Please confirm specifications.	Check the communication command specifications.
3	The input numerical value exceeds the set range.	Enter a proper value.
4	Incorrect input character string.	Enter a proper character string.
5	Too many characters.	Enter the correct number of characters.
6	The format of the parameter is wrong.	Check the communication command specifications.
7	No character string saved in the clipboard.	Copy a character string to the clipboard.
8	The character string saved in the clipboard is too long.	Paste a character string with the specified number of characters.
9	String's length has exceeded.	Enter the correct number of characters.
11	The module does not exist.	Check that the module is installed correctly.
12	No specified input channel.	Specify a channel that is installed.
13	Exceeded the number of channels which can be set.	Set the correct number of channels.
14	The same channel exist more than one.	Set a channel only once.
15	The specified number is set to manual.	Set the DO channel or internal switch <b>Type</b> to <b>Alarm</b> .
16	Please specify at least one channel.	Specify a channel.
31	Invalid input value. (in ascending order)	Set the calibration correction value to a value greater than the previous value.
41	No channel specified by formula.	Check the channel number specified by the expression.
42	MATH expression grammar is incorrect.	Check that the expression grammar is correct.
43	Invalid order of operators.	Check that the operator used in the expression in relation to the applicable operands meets the grammar requirements.
44	Too many operators for MATH expression.	The maximum number of operators in an expression has been exceeded. Reduce the number of operators, such as by splitting up the expression into multiple math channels.
45	Nonexistent constant specified in MATH expression.	Check the constant number specified by the expression.
49	Invalid operator or operand used.	Check that the expression grammar is correct.
91	This username is already registered.	Register another user name.
92	'quit' string cannot be specified.	Change the character string.
93	String including space cannot be specified.	Change the character string.
94	NULL cannot be specified.	Change the character string.
95	User ID already registered.	
96	This user name cannot be specified.	Change the character string.
101	Duplicated port number.	Enter a different port number for each function.
102	IP address class error.	Check the IP address.
103	Masked IP address is all 0s or 1s.	Check the subnet mask.
104	SUBNET mask is incorrect.	Check the subnet mask.
105	The net part of default gateway is not equal to that of IP address.	Check the IP address.
106	More than one address cannot be specified.	Only a single sender is allowed.
107	Number entered exceeds channel number range. Use another command.	Check the syntax of the Modbus command.
141	Duplicated loop number.	Set them so that they are not overlapped.
142	Exceeded maximum PID group number.	
143	Invalid loop number.	Enter the correct loop number.

## • Execution Errors

Code	Message	Description, Corrective Action, Ref. Section
201	Cannot execute because other users changed setting.	Perform the operation again.
202	This action is not possible because recording or math computation is in progress.	Execute after stopping recording or computing.
203	This action is not possible because sampling is in progress.	Execute after stopping recording.
204	This action is not possible because math computation is in progress.	Execute after stopping computing.
208	Control is in progress. Stop all control loops.	Stop all control loops. On the GX/GP main unit, select <b>All loops STOP</b> . On the Web application, use the Operation tab.
209	This action is not possible because recording or control is in progress.	
210	This action is not possible because control is in progress.	Stop all control loops.
211	This function is not possible now.	Check the GX/GP status, and then execute again.
212	This action is not possible because bar code data error.	Check the character string to be read in from the barcode.
213	This function is not available with invalid user.	
214	This function is not available with logged out user.	Log in and perform the operation.
221	This function is not possible because input number is over.	The limit is 50 messages (10 for free messages).
222	Failed to write while recording stopped.	Execute after starting recording.
223	Failed to write to postscript message area.	There are no data files that messages can be written in.
224	Failed to write message to outside of data range.	Move within the data range.
225	Failed to print.	For snapshot printing, wait a moment, and re-execute. Check the printer and network status.
226	This action is not possible because message writing.	Wait until the additional message writing is finished.
231	This action is not possible because saving is in progress.	Wait until saving is complete.
232	This action is not possible because formatting is in progress.	Wait until formatting is complete.
233	Data save is not possible because of insufficient media capacity.	Replace the external storage medium.
234	Invalid file or directory name.	Use alphanumeric characters and symbols.
235	This action is not possible because FTP transmission is in progress.	Execute after FTP data transfer is complete.
236	Cannot take successive snapshots. Wait 10 seconds or more in between snapshots.	Wait 10 seconds or more
242	End process can't proceed, because setting file is not saved to Media	Change the storage medium.
243	Exceeded max number of change.	Reduce the number below the maximum number of settings that can be changed.
244	Configuration error.	Failed to change settings, initialize, or reconfigure. Execute the operation again. (An error occurs if the power is interrupted while the operation is in progress.)
245	Execution error, lack of key.	Set the encryption function to On in the Encryption/ Certificate screen of Init/Calib, and then create a key.
246	Failed to process input value.	Check that the module is installed correctly.
251	Invalid user name or password.	Enter the correct name or password.
252	The login password is incorrect.	Check the password. If the password is lost, the password must be initialized by an administrator.
253	A user already logged in.	There is a user already logged in with the same name or started the login operation.
254	This entry is incorrect.	The maximum number of login users has been exceeded.
255	Password entered is incorrect.	Enter the correct password.
256	Same password not allowed.	Specify a different password.
257	Password is incorrect.	Enter the correct password.
258	This function is locked.	Log in using a user account that has permission to use the operation.
260	This user name is unable to use this mode.	Users cannot switch modes.
261	Wrong user ID or password.	Enter the correct user ID and password.
262	Log in failed, password expired.	Change the password.
263	No change for default password.	Set a password that is different from the default password.
264	This user ID and password combination is already in use.	Set them so that they are not overlapped.
265	Login inputs are incorrect.	Enter the correct login information.
272	This password became invalid.	On the GX/GP, because the wrong password has been entered consecutively for more than the permissible number of times, this user has been locked out.

Continued on next page

## 5.2 Troubleshooting

Code	Message	Description, Corrective Action, Ref. Section
273	Invalid user.	The account has been invalidated on the server. The account has been invalidated on the GX/GP.
274	Please enter more than 6 characters.	The account has been invalidated on the server. The account has been invalidated on the GX/GP.
281	Exceeds time deviation setting.	The time change made during recording exceeds the time deviation limit. Set the time within the Time deviation limit, which is set in Time basic settings of System settings. ▶ page 1-207 in section 1.23.4, "Setting the Time Zone, Gradual Time Adjustment, and Daylight Saving Time"
301	No modules to download the firmware.	Do not remove the module while firmware is being downloaded.
302	Firmware file not found.	Check that the firmware file exists on the specified medium.
303	Failed to read firmware file.	Download the firmware again. Check that the SD memory card is not damaged and that it is not disconnected while the firmware is being downloaded.
304	Corrupted firmware file.	Download the appropriate firmware from our Website.
305	Invalid firmware version.	Download the appropriate firmware from our Website.
306	Mismatch module type.	Download the appropriate firmware for the module type that you want to update from our Website.
307	Firmware download error.	Download the firmware again. Check that the SD memory card is not damaged and that it is not disconnected while the firmware is being downloaded.
311	Touch panel calibration failed. Please try again.	Perform touch screen calibration again.
321	Cannot operate specified loop.	Perform the operation on the correct loop number.
322	Invalid control parameter.	Enter a valid value less than the high limit.
323	Cannot operate in this control mode.	Check the control mode setting.
324	Auto-tuning in progress.	Wait for auto-tuning to complete, and then perform the operation again.
325	Auto-tuning failed.	Check the process.
326	Cannot operate in this control condition.	Check the control status.
327	Cannot operate in this control settings.	Check the control status.
331	Cannot change program mode.	Check the pattern settings and control status.
332	Specified pattern number does not exist.	Perform the operation on the correct pattern number.
333	Failed to open the program pattern file.	Load or create a pattern file.
334	Program operation already started.	
335	Program operation not started.	
336	Specified pattern number is not in program operation.	Select a pattern number that is running.
337	Cannot change current segment settings.	
338	Program is not in hold operation.	
339	Invalid program pattern file.	Check that the module is installed correctly.
341	Exceed PV range setting.	Check the PV range setting on the main unit and the pattern file.

### • Operation Errors

Code	Message	Description, Corrective Action, Ref. Section
501	Operation aborted due to media error.	Change the storage medium.
502	Not enough free space on media.	Not enough free space on the storage medium, or the limit of the number of directories has been exceeded. Change the storage medium.
503	Media not recognized.	Remove the storage medium, and set it again.
504	Media read error.	Change the storage medium.
505	Media write error.	
506	Failed to create the file.	
507	No file or directory.	Tried to access a file which does not exist in the internal memory.
508	Format error.	Reformat.
509	Unknown file type.	Check the extension. This is displayed when the format of a file specified for displaying the setting differences is not normal.
511	Invalid file or directory operation.	Tried to delete a directory containing files. Delete the files and directories in the directory first before executing the operation.
512	The file is already in use. Try again later.	Wait until the file is accessible.

Continued on next page



Code	Message	Description, Corrective Action, Ref. Section
514	No setting files.	Check the setting parameter file.
515	A template file is abnormal.	Check the report template file.
516	Some items not set.	Check the error log.
517	Media is read-only.	Make it writable.
518	Scale image not loaded.	Load a scale image. Set scale image settings to Off. Refer to 1.10.2 Setting Display Groups.
519	Template file not loaded.	Load a template file.
532	No data available.	This error occurs when there is no valid data in the internal memory. Specify valid data.
536	No data after the date and time.	Select an earlier time.
537	The specified screen cannot be displayed	Specify a valid screen.
539	No selected data.	This error occurs when there is no valid data in the internal memory. Specify valid data.
541	Printer not connected.	Check the printer settings. Check the printer and network conditions.
542	Printer busy.	Execute after printing is complete.
551	Module was detached.	Check that the module is installed correctly.
552	Detected newer version module.	Check the module version.
553	Unrecognized module.	Check that the module is installed correctly.
554	Fatal module error.	If the same message continues to appear even after you perform the procedure above, servicing is required. Contact your nearest YOKOGAWA dealer for repairs.
555	Non-calibrated module.	Perform A/D calibration.
556	RJC error module.	Servicing is required. Contact your nearest YOKOGAWA dealer for repairs.
557	A/D error module.	YOKOGAWA dealer for repairs.
558	Activation required for attached modules.	Activate modules.
561	Module was detached. Please readjust reminder settings.	Check that the module is installed correctly.
562	Detected pulse counter error modules.	Check that the module is installed correctly. If the same message continues to appear even after you perform the procedure above, servicing is required. Contact your nearest YOKOGAWA dealer for repairs.
570	The specified file does not exist.	Specify a valid file name.
571	The specified folder does not exist.	Check the folder name.
572	Deletion of the file went wrong.	Change the storage medium.
573	Deletion of the folder went wrong.	Change the storage medium.
581	Specified custom display file does not exist.	Download the custom display file.
582	Invalid custom display file.	The custom display file may be corrupt. Download the file again.
583	Image file does not exist.	Download the custom display file.
591	Certification saving error, memory full.	Delete the certificate, and then save it again.
592	Key is broken. Please generate key.	Create a key if you need encryption or electronic signature.
601	Error, already signed in.	You cannot change a file that has already been signed or overwrite a signature.
604	This file is not allowed to sign record.	Log in using a user account that has permission to use signatures, and then sign.
606	Request denied, busy while signing in data.	Signature information is being written to the file. Wait until writing is finished.
607	Insufficient information to sign in.	Because not all the data in the target file can be viewed on the GX/GP, the file cannot be signed. Sign using Universal Viewer.
611	System rebooted due to FPGA software error.	An FPGA (Field Programmable Gate Array) software error or device error was detected. To prevent erroneous operation, the system was restarted. If the system does not recover, contact your nearest YOKOGAWA dealer. ▶ page 5-45 in section 5.2.3, "Auto restart when a device error occurs (release number 4 (version R4.04) and later)"

## Communication Application Errors

### • Errors Related to E-mail

Further details are provided by the character string (detail code) that appears after code.

Code	Message	Character String	Description, Corrective Action, Ref. Section
651	IP address is not set or ethernet function is not available.	HOSTADDR	An IP address has not been assigned to the GX/GP. Check the IP address settings.
652	SMTP server is not found.	HOSTNAME	The SMTP server host name is invalid. Check the DNS address setting on the GX/GP. Also, check the SMTP server address setting.
653	Cannot initiate E-mail transmission.	HELO	Failed to log in to the SMTP server. Check the user authentication settings of the SMTP server.
654	Sender's address rejected by the server.	MAILFROM	Failed to log in to the SMTP server. Check the user authentication settings of the SMTP server.
655	Some recipients' addresses are invalid.	RCPTTO	The recipient address was rejected by the SMTP server. Check the recipient address settings.
656	SMTP protocol error.	DATA	The mail body was rejected by the SMTP server. Check whether the SMTP server is operating properly.
		TCPIP	Internal processing error. Contact your nearest YOKOGAWA dealer.
657	Ethernet cable is not connected.	LINK	The Ethernet cable is not connected. Check the Ethernet cable connection.
658	Could not connect to SMTP server.	UNREACH	Failed to connect to the SMTP server. Check the Ethernet cable connection. Also, check the SMTP server address setting.
660	E-mail transfer error.	TIMEOUT	The response from the SMTP server timed out. Check that the Ethernet cable is connected correctly. Also, check whether the SMTP server is operating properly.
671	Could not connect to POP3 server.	POP3UNREACH	Failed to connect to the POP3 server. Check the POP3 server address setting.
		POP3HOSTNAME	The POP3 server host name is invalid. Check the DNS address setting on the GX/GP. Also, check the POP3 server address setting.
672	Not able to login to the POP3 server.	POP3TIMEOUT	The response from the POP3 server timed out. Check that the Ethernet cable is connected correctly. Also, check whether the SMTP server is operating properly.
		POP3AUTH	User authentication on the POP3 server failed. Check whether the user name and password for POP3 authentication are correct.
673	SMTP authentication failed.	SMTPAUTH	Check whether the user name and password for authentication are permitted on the server.
674	The server requested an unsupported authentication method.	ANOTSUPPORT	Use the appropriate authentication method, or change the server configuration.

### • Errors Related to FTP Client

Detail codes are not displayed for error messages on the screen. You can view them on the GX/GP FTP log screen or through an FTP log output via communication.

Further details are provided by the character string (detail code) that appears after code.

Code	Message	Character String	Description, Corrective Action, Ref. Section
657	Ethernet cable is not connected.	LINK	The Ethernet cable is not connected. Check the Ethernet cable connection.
691	IP address is not set or FTP function is not available.	HOSTADDR	An IP address has not been assigned to the GX/GP. Check the IP address settings.
692	FTP control connection error.	UNREACH	Failed to connect to the FTP server. Check whether the GX/GP IP address and the connection destination FTP server are set correctly.
		REPLY	An error response was received from the FTP server. Check whether you have privileges to write files to the destination FTP server.
		SERVER	An unknown response was received from the FTP server. Check whether you are using the correct FTP server.
		HOSTNAME	The specified FTP server host name is invalid. Check the DNS and host name settings.
693	FTP command was not accepted.	COMSEND	Failed to send a command to the FTP server. Check whether the Ethernet cable is connected and whether the FTP server is down.
		COMRECV	Failed to receive a response from the FTP server. Check whether the Ethernet cable is connected and whether the FTP server is down.
		USER	The specified user name is not registered on the destination FTP server. Check whether the user name is set correctly.
		PASS	Password authentication failed at the destination FTP server. Check whether the password is set correctly.
695	FTP data connection error.	CONNECT	Failed to establish a data transfer connection with the FTP server. PASV mode may be necessary depending on the network environment. Check the PASV mode settings.
		RECV	Failed to receive data over the data transfer connection with the FTP server. Check whether the Ethernet cable is connected and whether the FTP server is down.
		SEND	Failed to send data over the data transfer connection with the FTP server. Check whether the Ethernet cable is connected and whether the FTP server is down.
696	FTP file transfer error.	FILE	File operation failed during file transfer. Check whether the external storage medium is inserted.
698	Connection time-out occurred for FTP.	TIMEOUT	Connection with the FTP server timed out. Check whether the Ethernet cable is connected and whether the FTP server is down.
699	An error occurred for FTP	TCPIP	An internal processing error occurred. Contact your nearest YOKOGAWA dealer.
		NOFD	
		NOID	
		PARAM	

#### Note

- The FTP client function on the GX/GP has a timer function that drops the connection if there is no data transfer for two minutes. If the server does not respond within this time period, the transfer fails.
- The FTP client function on the GX/GP overwrites files without a warning if files with the same name exist at the transfer destination unless the server returns a negative response.

### • SNTP Errors

Code	Message	Character String	Description, Corrective Action, Ref. Section
711	SNTP access failure.	ESEND	Failed to transmit data to the SNTP server. Check the GX/GP Ethernet cable connection and IP address setting.
		ERECV	Failed to receive data from the SNTP server. Check the GX/GP Ethernet cable connection and IP address setting.
		EDORMANT ETCPIP	An internal processing error occurred. Contact your nearest YOKOGAWA dealer.
712	SNTP server does not respond.	ETIMEDOUT	The response from the SNTP server timed out. Check the GX/GP Ethernet cable connection.
713	Incorrect SNTP server setting.	EHOSTNAME	The SNTP server host name is invalid. Check the GX/GP Ethernet cable connection, IP address setting, and SNTP server address setting.
714	Invalid SNTP server reply.	EBROKEN	The SNTP server returned an invalid response. The SNTP server may be in a condition that cannot deliver time information. Check the SNTP server status.
715	No time correction because excess time deviation with SNTP server.	EOVER	The time difference between the GX/GP and SNTP server has exceeded the limit for correcting the time. Check whether the SNTP server is running properly and the limit for correcting the time.

### • DHCP Errors

Code	Message	Character String	Description, Corrective Action, Ref. Section
721	IP address was released because DHCP setting is invalid.	REJECTING	The IP address obtained from the DHCP server was rejected. Check whether the DHCP server is operating properly. If the GX/GP cannot accept the IP address obtained from the DHCP server, the GX/GP rejects the address and immediately returns a response to the DHCP server.
722	DHCP access failure.	ESEND	DHCP message transmission failed. Check the Ethernet cable connection.
		ESERVER	DHCP server search failed. Check whether the DHCP server is available.
		ESERVFAIL	The response from the DHCP server timed out. Check the Ethernet cable connection. Check whether the DHCP server is operating properly.
		ERENEWED	IP address renewal failed. Check the Ethernet cable connection. Check whether the DHCP server is operating properly.
		EEXTENDED	IP address extension application failed. Check the Ethernet cable connection. Check whether the DHCP server is operating properly.
		EEXPIRED	IP address lease period expired. IP address was reset to 0.0.0.0. Check the Ethernet cable connection. Check whether the DHCP server is operating properly.
723	Registration of the hostname to the DNS server failed.	EFORMERR	DNS message syntax error was found. Check whether the DNS server is operating properly.
724	Deletion of the hostname to the DNS server failed.	ESERVFAIL	An internal processing error occurred in the DNS server. Check whether the DNS server is operating properly.
		ENXDOMAIN	Query to the DNS server was rejected.
		EREFUSED	Check whether the GX/GP domain name setting is correct.
		EINTERNAL	
		ENONAME	
		EYXDOMAIN	The GX/GP does not support DNS servers that require host name registration authentication. Check whether the DNS server supports host name registration without authentication.
		EYXRESET	
		ENXRESET	
ENOTAUTH			
		ENOTZONE	

## • Other Communication Errors

Code	Message	Character String	Description, Corrective Action, Ref. Section
731	Connection has been lost.	—	<p>If the GX/GP receives data of improper protocol using general purpose communication (Ethernet or serial communication), the GX/GP generates error 731 and disconnects the connection.</p> <p>(1) For an Ethernet connection, check the GX/GP Ethernet cable connection.</p> <p>(2) For a serial connection, check the cable connection and the serial communication settings (baudrate, etc.).</p>
732	The number of simultaneous connections has been exceeded.	—	<p>This message is output when an attempt is made to establish five or more connections to the GX/GP using general purpose communication (Ethernet).</p> <p>(1) Reduce the number of simultaneous connections.</p> <p>(2) Check whether there is a connection from another PC.</p> <p>(3) Turn on the timeout function in server settings.</p>
733	Communication has timed-out.	—	<p>This message is output when communication times out on general purpose communication.</p> <p>(1) Check the timeout value in server settings.</p> <p>(2) Reconnect to the GX/GP.</p>
781	Failed to establish encrypted communication.	—	<p>Check the key, certificate, communication settings, and host device.</p>
782	Communication failed due to certificate.	—	<p>Failed to verify the certificate received from the server.</p> <p>Select the unverified certificate, and check the details.</p>
783	Wrong validity certificate.	—	<p>There is an error in the validity of the certificate received from the server or a trusted certificate in the device.</p>

- **Errors for When the Advanced Security Function (/AS option) Is in Use**

Code	Message	Description, Corrective Action, Ref. Section
277	Does not meet password policy requirements.	This is displayed when changing the password. Enter a password that satisfies the password policy.
520	System configuration is different.	This is displayed when the system configuration of the two setting files specified for displaying the differences is different and cannot be compared.
521	Failed to save setting file automatically.	Automatic saving of the setting file failed when the recording was stopped. Check whether the external storage medium is inserted correctly.
760	Invalid KDC client configuration.	Set the host principal or realm name.
761	Cannot find KDC server.	The KDC server cannot be found in the same domain.
762	KDC server connection error.	An error occurred while the GX/GP was connecting to the KDC server. Make sure that the network connection is not broken.
763	Not supported by this machine.	Not supported by the GX/GP.
764	Preauthentication failed.	Enter the correct password. Also, make sure that the times on the GX/GP and the server match.
765	The encryption type is not supported by this machine.	The GX/GP does not support the encryption type, or the encryption type settings on the GX/GP and the server are different. Use the same encryption method on the GX/GP and the server.
766	Failed to receive authentication from KDC server.	Check the GX/GP and server settings. Also, make sure that the times on the GX/GP and the server match.
767	Change the password.	Change the password. Change the password of the user account that is registered on the server.
768	The time difference with the KDC server exceeds the limit.	There is a time difference of 5 minutes or more between the GX/GP and the server. Synchronize the GX/GP time to the time on the server.
770	The host principal is not registered.	The host account is not registered on the server.
771	The host principal is invalid.	Check the host account that is registered on the server.
772	The host password is incorrect.	Make sure that the GX/GP authentication-key password and the server's host-account password match.
773	Preauthentication failed.	An internal error occurred during preauthentication. Disable the server's preauthentication function. The receivable token size is exceeded. The maximum token size that SMARTDAC+ can receive is 64 KB. Set the server's maximum token size to 64 KB or less, or disable the server's preauthentication function.
774	The realm is incorrect.	Make sure that the realm name setting on the GX/GP is correct.
885	Password is about to expire. Please change the password.	This is displayed immediately after login according to the "advance notice of expiry date" setting.

## Communication Errors

For information about the GX/GP communication functions, see the *Communication Command User's Manual*, IM04L51B01-17EN.

### • Execution Errors

Code	Message	Description, Corrective Action, Ref. Section
351	Command is too long.	Check the communication command specifications.
352	Unknown command.	
353	This command is not permitted in this user.	Log in using a user account that has permission to use the operation.
354	This command is not permitted in this mode.	
355	The option is not installed.	Check the communication command specifications.
356	This command is not permitted in this setting.	Log in using a user account that has permission to use the operation.
357	Wrong command arguments number.	Check the communication command specifications.
358	This command does not support a query.	
361	Wrong error number.	This is an unregistered error number. Please check the error number.
401	A user name and password is required.	Log in.
402	Required userID/Password.	Returned by the GX/GP when the advanced security function is enabled and connection is being established. See appendix 2, "Login Procedure" in the Communication Command Manual (IM04L51B01-17EN).
411	Exceeded number of selection.	In manual select saving, set the number of specified data files to 50 or less.
412	No data exists.	Check that the file specified by memory summary and the like exists.

## Status Messages

Code	Message
801	Execution completed.
802	Please wait a moment...
803	Saving data to media.
804	Loading file from media.
805	Memory save to media stopped.
806	Data save completed.
807	Sorting files now.
808	Formatting...
809	Post process in progress.
810	Now loading historical data.
811	No unsaved data.
812	Media mounted.
813	Safe to remove media.
814	Media removed improperly.
815	Failed to mount the media.
816	USB device connected.
817	Failed to recognize the USB device.
818	Press [MENU] key to login.
819	Wrong format media.
821	Ethernet cable connected.
822	Ethernet cable disconnected.
823	Connecting to the line...
824	Sending data file.
825	Executing FTP test.
826	Executing e-mail test.
827	Now connecting to SNTP server...
828	Querying to DHCP.
830	Received response from DHCP.
831	IP address set.
832	No hostname registration to DNS server in current settings.
833	Registered hostname to DNS server.
834	Deleted hostname in DNS server.
836	KDC test connection succeeded.
837	Login may be impossible in incorrect KDC client settings.
841	Now adjusting the time.
850	Saving Settings.
851	Attached a module.
852	Updating I/O module firmware.
853	System reconstruction in progress.
854	Executing A/D calibration.
855	Initialization in progress.
856	Writing the A/D calibration value.
857	Resetting the A/D calibration value.
858	Detected new modules. Required System Reconfiguration.
860	Please set as recording channel.
861	Noise may influence measurement in fast mode.
862	Please acknowledge all active alarms before stopping this record.
863	Changed the recording interval.
864	Setting changes exceeded 50. Not possible to save beyond 100. Please save now.
865	"Relay Action on ACK" setting of all DO channel will change to "reset".
866	Not available for electric signature. Please set the certificate.
867	Not available for encrypted comm. Please set the certificate.
865	"Relay Action on ACK" setting of all DO channel will change to "reset".
868	Chattering filter may not function. Please update module to R1.04.01 or later.
869	Before saving these settings, register users in the User settings menu under Security settings.
875	Failed to display some components.
876	Currently in operation.
877	Time event setting has changed.
878	Input time event time less than segment time.
880	Reconfigure pattern data related to control loops (Starting target setpoint, wait settings, and segment settings)
881	Initialized measured data and settings.
882	Initialized measured data.
891	Changed the language. Please reboot the system.
892	Please reboot the system.



## System Errors

Servicing is required when a system error occurs. Contact your nearest YOKOGAWA dealer for repairs.

Code	Message	Description, Corrective Action, Ref. Section
901	ROM failure.	Servicing is required. Contact your nearest YOKOGAWA dealer for repairs.
902	RAM failure.	Servicing is required. Contact your nearest YOKOGAWA dealer for repairs.
911	A/D calibration value error.	
912	A/D calibration error.	Check that the reference value is correct. Check that the wiring is correct. If the same message continues to appear even after you perform the procedure above, servicing is required. Contact your nearest YOKOGAWA dealer for repairs.
913	Incorrect number for the A/D calibration.	Select a number of a module that has been detected.
914	Failed to write A/D calibration value.	Failed to write A/D calibration values to the module. Check that the module is installed correctly. Do not remove the module during calibration. If the same message continues to appear even after you perform the procedure above, servicing is required. Contact your nearest YOKOGAWA dealer for repairs.
915	Failed to receive A/D calibration value.	Failed to receive A/D calibration values from the module. Check that the module is installed correctly. Do not remove the module during calibration. If the same message continues to appear even after you perform the procedure above, servicing is required. Contact your nearest YOKOGAWA dealer for repairs.
916	Incorrect A/D calibration procedure.	Calibrate correctly.
921	Memory acquisition failure.	Perform the following tasks. 1. Stop recording. 2. Save the measured data that is stored in internal memory to an external storage medium. 3. Initialize the internal memory data. If the same message continues to appear even after you perform the procedure above, servicing is required. Contact your nearest YOKOGAWA dealer for repairs.
922	The ethernet module is down.	
923	A hardware test failed.	Servicing is required. Contact your nearest YOKOGAWA dealer for repairs.
924	The backup battery is low.	
925	Touch screen failure	Stop recording and other operations so that the power can be turned off. Then, turn off the power and then back on. If the same message continues to appear even after you perform the procedure above, servicing is required. Contact your nearest YOKOGAWA dealer for repairs.
951	Data are not written at the flash memory area for production.	Servicing is required. Contact your nearest YOKOGAWA dealer for repairs.
952	A SUM value of the flash memory area for production is incorrect.	
953	The reading of the flash memory area for production failed.	
954	The writing of the flash memory area for production failed.	
997	Display memory shortage.	
999	System error.	

### Note

If E819 occurs, take the following corrective action.

- SD memory card  
Format the SD memory card using the SD memory card formatter distributed by the SD Association.
- USB flash memory  
Format to FAT16 or FAT32 with a 32 KB or smaller cluster size.

## Messages That the Web Application Generates

### Error Messages

Code	Title Message	Description and Corrective Action
E8001	Communication error A communication error has occurred.	Unable to finish processing because communication with the GX/GP failed. Check the communication condition.
E8002	Authentication error Login failure; the page will be reloaded.	Due to a change in the user registration settings on the GX/GP, an authentication procedure has occurred while the Web application was running and has failed. Click OK in the dialog box to reload the page.
E8003	Configuration loading error Failed to load hardware configuration. <b>Auxiliary Message</b> 1 There is a communication error or the hardware is busy. 2 The configuration you are loading is not fully compatible with the existing configuration of hardware.	This message appears when the Web application fails to load settings from the GX/GP. The system configuration or settings on the GX/GP have been changed, and a conflict has occurred with the settings displayed by the Web application. Check the system configuration and settings on the GX/GP. Also, check the communication condition.
E8004	Configuration updating error Failed to update hardware configuration. <b>Auxiliary Message</b> 1 There is a communication error or the hardware is busy. 2 The configuration you are updating is not fully compatible with the existing configuration of hardware. 3 There are invalid MATH expressions. 4 This username is already registered.	This message appears when the Web application fails to change the GX/GP settings. There is a conflict in the system configuration or settings between the GX/GP and the Web application. Reload the settings to align the Web application settings to the GX/GP settings (settings that have been edited will be discarded). Error in expression. A user with the same user name is already registered.
E8005	File The file name is invalid. <b>Auxiliary Message</b> 1 A file name can not contain any of the following characters. \**/:<>? '; 2 The length of file name is up to 32 characters.	Set the file name using up to 32 alphanumeric characters.
E8006	Configuration error Failed to update favorite monitors due to communication error. <b>Auxiliary Message</b> 1 The configuration is not fully compatible with the existing configuration of hardware.	When AI channels are being configured, the available alarm range of channels that are set to Log scale are retrieved from the GX/GP via communication. If a communication error occurs during this process, the available range cannot be retrieved, and this message is displayed.
E8008	Authentication error Password entered is incorrect.	The passwords entered for the new password and confirmation do not match when changing the password at login (when the password is initialized or when the password is expired). Enter the same character string for both.
E8010	Program operation Program operation not started.	This message appears when you press RUN PANEL on the program selection screen when programs are not running on any of the pattern numbers. (This function is for switching to a running pattern screen.)
E8601	Registration error The monitor name must be 1-16 characters in length.	Use 1 to 16 characters to set the favorite monitor name.
E8602	Registration error Failed to add a monitor because the maximum number of allowed monitors has been reached.	Delete at least one favorite monitor and start over, or overwrite an existing favorite monitor.
E8603	Registration error Failed to update favorite monitor information; this action has already been performed. Please reload the page.	Because the favorite monitor information that the browser has detected is different from what is stored in the GX/GP, registering, overwriting, or deleting of the favorite monitor failed. Reload the page.

Continued on next page

Code	Title Message	Description and Corrective Action
E8604	Communication error Failed to update favorite monitors due to communication error.	Operation failed due to a communication error. Check the communication conditions.
E8605	Communication error Communication error occurred. Please restart the web browser.	Follow the instruction below to restart the browser. 1 Close the browser. 2 Check the communication conditions. 3 Start the browser, and connect to the Web application.
E8608	No data. Please reload.	The selected data does not exist. Reload the page to retrieve the current information.
-	Failed to change value.	Failed to change an alarm value, DO output value, or internal switch value. This appears in the channel information dialog box.
-	Failed to ACK alarm.	Individual alarm ACK failed. This appears in the channel information dialog box.

## Warning Messages

Code	Title Message	Description and Corrective Action
W8101	Clear the editing Are you sure you want to clear the edited content?	This confirmation message appears when you edit settings and try to move to a different setting screen without clicking <b>Update Config</b> .
W8102	Reload configuration If the display language is changed, the page will be reloaded.	This confirmation message appears when you try to change the language setting.
W8103	Update configuration Are you sure you want to update the hardware configuration? <b>Auxiliary Message</b> 1 Communication will be disconnected when you change ethernet basic settings.If it be disconnected, please reconnect with new settings. 2 Communication will be disconnected when you change to HTTP Off. You can not change HTTP On from the web application. 3 Communication will be disconnected when you change the port number for HTTP. After the configuration is completed, please reconnect with the new port number. 4 Change the communication security. After the configuration is completed, the page reload or user authentication are required. 5 Change user settings, including current log in. After the configuration is completed, page reload or user authentication are required. 6 Before save this configuration, do the user registration from security settings - User settings menu.	This confirmation message appears when you click <b>Update Config</b> in a setting screen.
W8104	Update configuration Restart is required to reflect this changes. Continue?	This confirmation message appears after you change the settings when the GX/GP needs to restart.
W8105	Reload configuration Are you sure you want to clear the edited contents by reloading the configuration?	This confirmation message appears when you click <b>Reload</b> in a setting screen.
W8106	Destruction of editing Are you sure you want to clear the edited monitor?	This message appears for you to confirm whether to discard the current monitor and move to different content. If you want to save the monitor configuration, register the monitor as a favorite monitor, and then move to different content.
W8107	Login user changed Login user has chanded. The page will be reloaded.	Due to a change in the user registration settings on the GX/GP, an authentication procedure has occurred while the Web application was running, and as a result, the login user has changed. Click <b>OK</b> to reload the page.

Continued on next page

## 5.2 Troubleshooting

Code	Title Message	Description and Corrective Action
W8108	Hardware configuration Hardware system configuration has changed. The information will be updated.	This message appears on the system information screen or network information screen when the system configuration changes on the GX/GP. Click <b>OK</b> to update the information.
W8109	Limit of configuration editing This configuration includes contents that could not be changed. <b>Auxiliary Message</b> 1 The hardware is recording data or executing math, so the configuration cannot upload. 2 The configuration you are loading includes the contents that cannot be changed from the web application.	This message appears when setting parameters are loaded. It indicates that restrictions will be placed on the configuration capabilities due to the GX/GP condition or design limitations of the Web application.
W8110	Limit of configuration editing The hardware was operated, so this operation will affect the configuration. <b>Auxiliary Message</b> 1 The hardware is recording data or executing math, so the configuration cannot upload. 2 The hardware was operated. The configuration is not fully compatible with the existing configuration of hardware. 3 The hardware is currently running control, therefore, the configuration cannot be loaded.	This message appears when settings are being displayed. It indicates that restrictions will be placed on the configuration capabilities due to changes in the GX/GP condition.
W8111	Save all Save files to the current folder? <b>Auxiliary Message</b> • Setting parameters, Scale image, Report template, Trusted Certificate, Certificate, Custom display (/CG) • Program pattern	This message appears during all settings save.  This message appears only when a PID module is detected on a model with the Program control function (/PG).
W8112	Load all Load files from the current folder? <b>Auxiliary Message</b> • Setting parameters, Scale image, Report template, Trusted Certificate, Custom display (/CG) • Program pattern	This message appears during all settings load.  This message appears only when a PID module is detected on a model with the Program control function (/PG).
W8122	Unverified certificate Communication failed due to certificate. <b>Auxiliary Message</b> 1 Operation: Unverified certificate	Check the certificate. You can display the details of a problematic certificate and execute authentication (or load) by using Unverified certificate from the menu.
W8123	Certificate Installed certificate exists. Overwrite the certificate?	This message appears during certificate installation when a certificate is already installed when you are creating a self-signed certificate.
W8125	Communication Communication disconnected. Please reload later.	This message appears while waiting for the results of processing when some time elapses after communication is disconnected.
W8127	Mode Switching Switch to update mode?	This message appears when you click the Update button for the A/D calibration content.
W8129	Web application Layout may be displayed incorrectly when the Web browser zoom is not 100%.	Set the Web browser zoom to 100%. This message appears only once when you start the Web application.
W8134	Save all settings Same folder name exists, overwrite ?	This confirmation message appears when the folder name specified for all settings save already exists.
W8136	Update configuration Multi batch settings have been changed. <b>Auxiliary Message</b> 1 Please reload after restart of the hardware.	This message appears when the Web application detects a change in the multi batch settings. Reloading is necessary to avoid conflict between the GX/GP and Web application.

Continued on next page

Code	Title Message	Description and Corrective Action
W8137	Multi batch settings Are you sure you want to update the hardware configuration? <b>Auxiliary Message</b>	This confirmation message appears when you click Update Config. in the multi batch setting screen.
	1 System is rebooted. All initialization is done except log, communication basic settings, and Communication server settings. Is it OK?	
W8138	Auto-tuning CAUTION: Do not perform auto-tuning for the following processes. Tune PID manually. <b>Auxiliary Message</b>	This message appears when you click Auto-tuning (AT: OFF) on the tuning screen.
	1 Processes with fast response such as flow rate control and pressure control.	
	2 Processes which do not allow the output to be turned on and off even temporarily.	
	3 Processes which prohibit output changes at control valves (or other actuators).	
	4 Processes in which product quality can be adversely affected if PV values fluctuate beyond their allowable ranges.	
W8139	Abort auto-tuning Abort auto-tuning?	This message appears when you try to stop auto-tuning while auto-tuning is in progress.
W8141	Program operation (PROGRAM RUN/RST) Execute program control RUN/RESET.	This message appears when you click PROGRAM RUN/RESET on the program operation screen.
W8142	Program operation (PROGRAM RUN) Start program control?	Clicking OK on the program selection screen starts the operation of the displayed pattern number.
W8143	Advance of segment (ADVANCE) Advance program to the next segment?	This message appears when you click ADVANCE on the program operation screen.
W8144	Switch to HOLD (HOLD) Hold program operation?	This message appears when you click HOLD on the program operation screen.
W8145	Switch to HOLD (HOLD) Release hold operation?	This message appears when you click HOLD on the program operation screen in hold mode.
W8146	Pattern number (SET PT NO.) Change action pattern number into displayed pattern number? <b>Auxiliary Message</b>	This message appears when you click SET PT NO on the program selection screen.
	• Pattern number: xx	
W8147	Update configuration Measurement mode have been changed. <b>Auxiliary Message</b>	This message appears when the measurement mode is changed on the main unit.
	• Please reload after restart of the hardware.	
W8148	Update configuration If this web option is changed, the page will be reloaded.	This message appears when you change the following items from the Web option dialog box. • Language • Control screen background
W8156	Web application Layout may be displayed incorrectly in case of display zoom or browser zoom is not 100%. It may be fixed by changing browser zoom.	If using Chrome, this message is displayed if the zoom factor in the Windows display settings or the browser is not 100%. The layout of the table header on the settings page can become disrupted. Changing the browser's zoom factor may alleviate the problem.

Continued on next page

## 5.2 Troubleshooting

Code	Title Message	Description and Corrective Action
W8701	Favorite monitor The monitor with the same name already exists. Do you want to overwrite it?	This message confirms whether it is okay to overwrite an existing favorite monitor. If you do not want to overwrite, click <b>Cancel</b> , and then register with a different name.
W8702	Favorite monitor Are you sure you want to delete \"%s\"?"	This message confirms whether it is okay to delete a favorite monitor. The "%s" section will contain the favorite monitor name.

## Information Messages

Code	Title Message	Description and Corrective Action
M8201	Hardware configuration Hardware system configuration has changed.	This message appears when the system configuration changes on the GX/GP.
M8202	Update configuration Configurations were updated successfully.	The GX/GP settings have been successfully changed.
M8203	Update Mode Hardware is in Update mode. Please wait. <b>Auxiliary Message</b> 1 Module updating... (xxx%) 2 Modules not updated. 3 Web application updating... (xxx%) 4 Web application not updated.	<p>This message appears in the following cases.</p> <ul style="list-style-type: none"> <li>• When a connection is made with the GX/GP in update mode</li> <li>• While connected to the GX/GP in normal mode, another Web browser changes the GX/GP to update mode</li> </ul> <p>This auxiliary message appears in the following cases.</p> <ol style="list-style-type: none"> <li>1 When module updating is in progress</li> <li>2 When module updating is not in progress</li> <li>3 When Web application updating is in progress</li> <li>4 When Web application updating is in not progress</li> </ol> <p>While updating is in progress, the Exit current mode button cannot be used. Mode cannot be switched with a User connection. The Exit current mode button will be hidden.</p>
M8204	A/D Calibration Mode Hardware is in A/D calibration mode. Please wait.	<p>This message appears in the following cases.</p> <ul style="list-style-type: none"> <li>• When a connection is made to the GX/GP in A/D calibration mode</li> <li>• While connected to the GX/GP in normal mode, another Web browser changes the GX/GP to A/D calibration mode.</li> </ul> <p>When returning the GX/GP to normal mode, confirm that the GX/GP is not executing A/D calibration. Mode cannot be switched with a User connection. The Exit current mode button will be hidden.</p>
M8205	Key Creation Mode Created key pairs. Please reboot the system. <b>Auxiliary Message</b> 1 Key not created. 2 Key creation in progress. (xxx%)	<p>This message appears in the following cases.</p> <ul style="list-style-type: none"> <li>• When a connection is made to the GX/GP in key creation mode</li> <li>• While connected to the GX/GP in normal mode, another Web browser changes the GX/GP to key creation mode</li> </ul>
M8211	Paste To paste, please press Ctrl + v or paste from the browser menu.	This message is displayed when you click the on-screen Paste button in Chrome.
M8801	Message The message was written successfully.	Message writing has been completed successfully.
M8802	Resumption of monitors Monitors resumed operation following setting changes.	The paused condition has been cleared due to a setting change in the GX/GP that would cause the monitor to be initialized.

## Expansion Module Error Codes

Error	Error Name	Error Description	Corrective Action
F1	Secondary boot read error	Failed to read the secondary boot program of the expansion module. There may be a problem reading the flash RAM.	Contact your nearest YOKOGAWA dealer.
F2	Firmware download error	Failed to read the flash RAM of the expansion module.	
F3	DRAM read error	There is an error in the DRAM of the expansion module.	
F4	System data error	There is an error in the system data (MAC address, product serial number) of the expansion module.	
F5	Ethernet error	There is an error in the EXBus controller of the expansion module.	
E1	Unit number error	The unit number setting is incorrect.	Set the unit number in the range of 0 to 6.
E2	Multiple expansion module connection	There are multiple expansion modules connected to the GX main unit or the extended unit.	Install a single expansion module in the correct slot.
E3	Slot error	An expansion module was installed to an in appropriate slot position when the module is operating in slave mode.	Install the expansion module in the correct position.
E4	Duplicate unit numbers	There are duplicate expansion module unit numbers.	Turn off the GX/GP main unit and all sub units and expandable I/O units that are connected. Then, reassign the unit numbers so that they do not overlap.
E5	Download error	Failed to update the expansion module.	Update the expansion module again.
E6	Extended unit master mode error	The master I/O expansion or slave I/O expansion operation setting of the expansion module is incorrect.	Set dipswitch 8 of the expansion module correctly.
E7	EXBus connection error	A device other than an expansion module is connected to EXBus.	Disconnect devices other than the expansion module from EXBus.
Px (x: 0 to 5)	Module insertion and removal	Appears when a module is inserted or removed. x indicates the slot number.	–

### 5.2.2 Troubleshooting

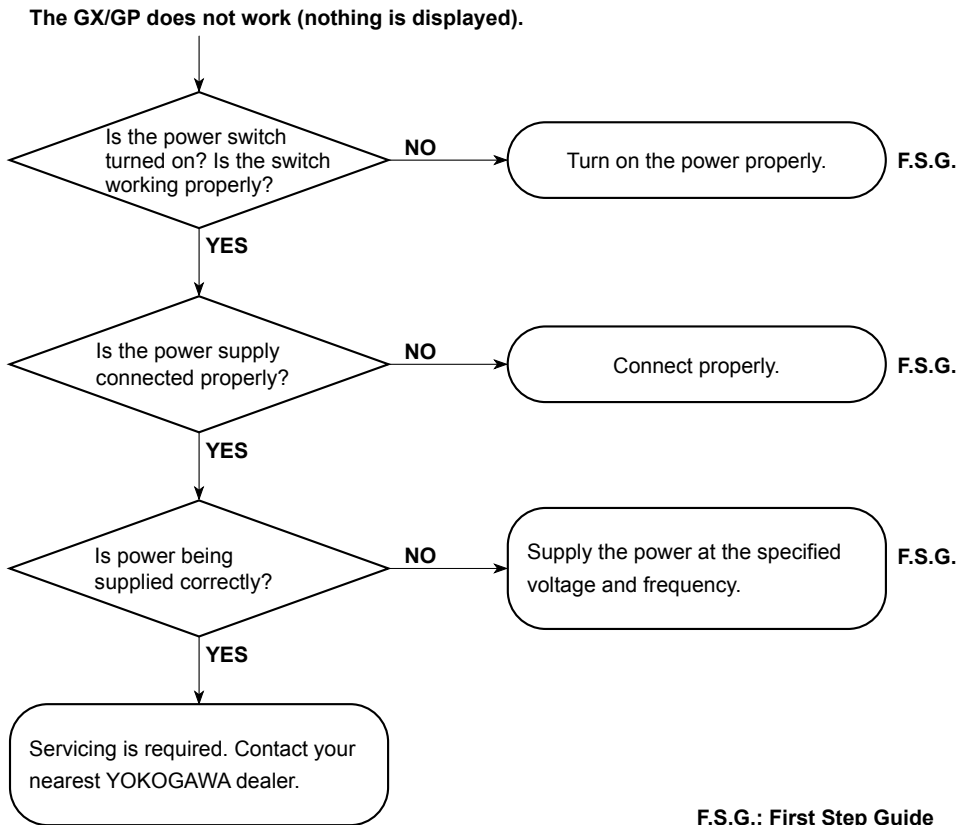

F.S.G.: First Step Guide



- The error is large.
- The trend or digital values fluctuate.
- The trend is off the scale on either the 0% or 100% side.

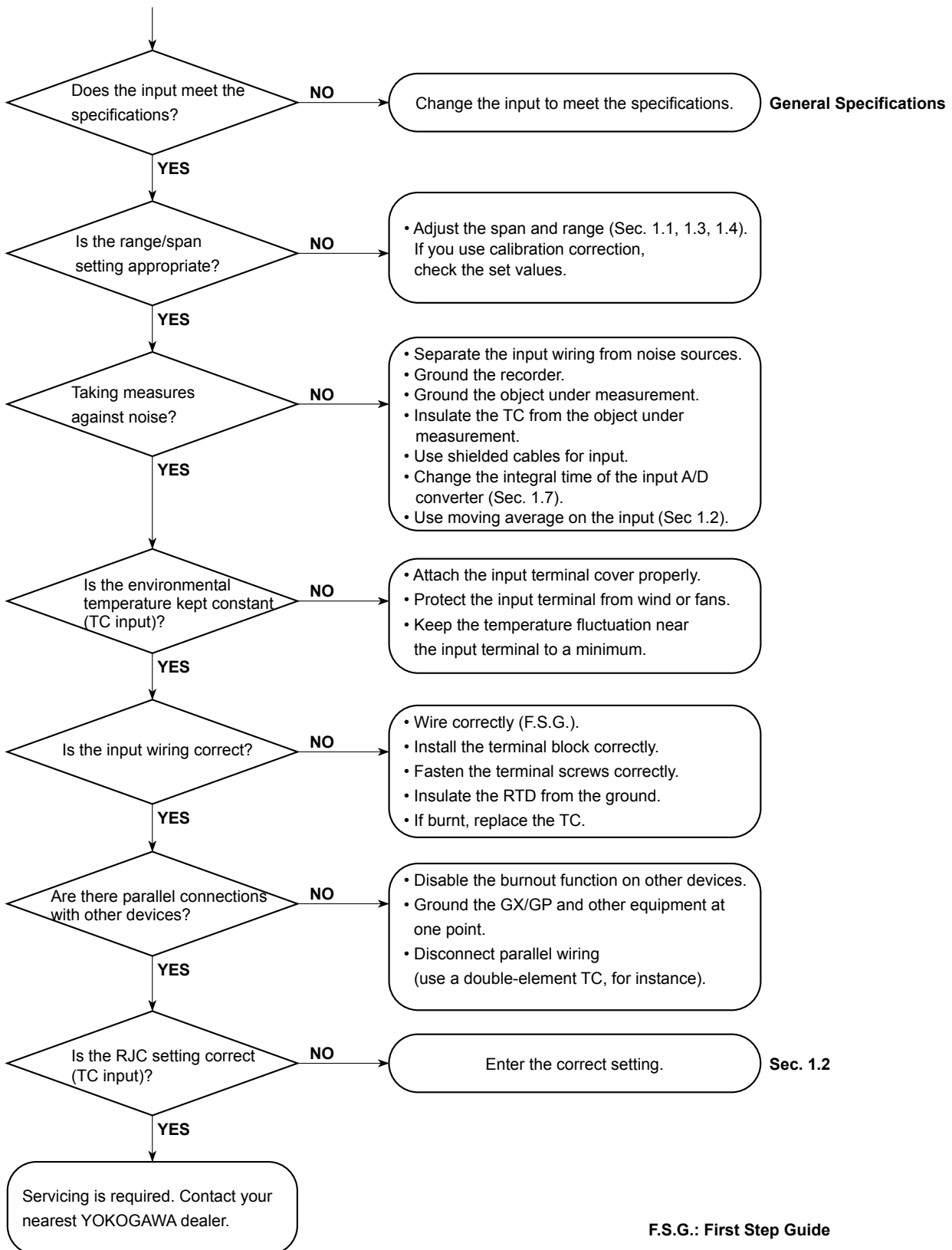

F.S.G.: First Step Guide

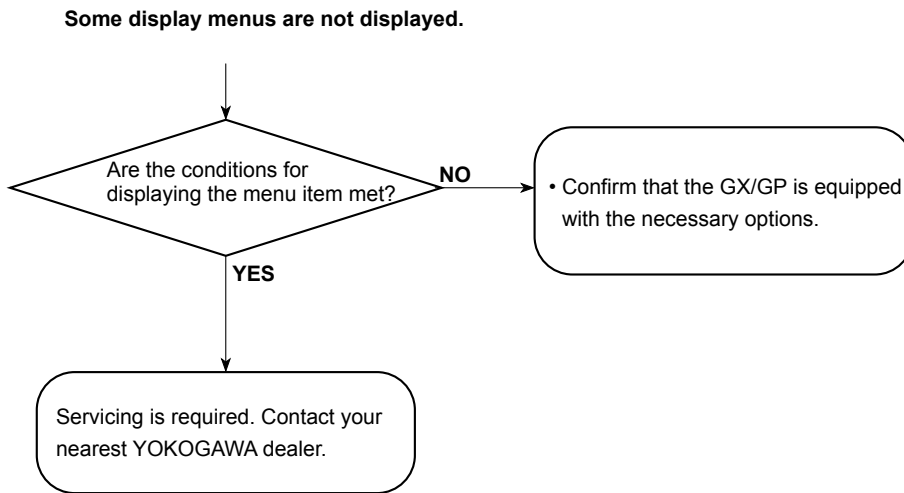
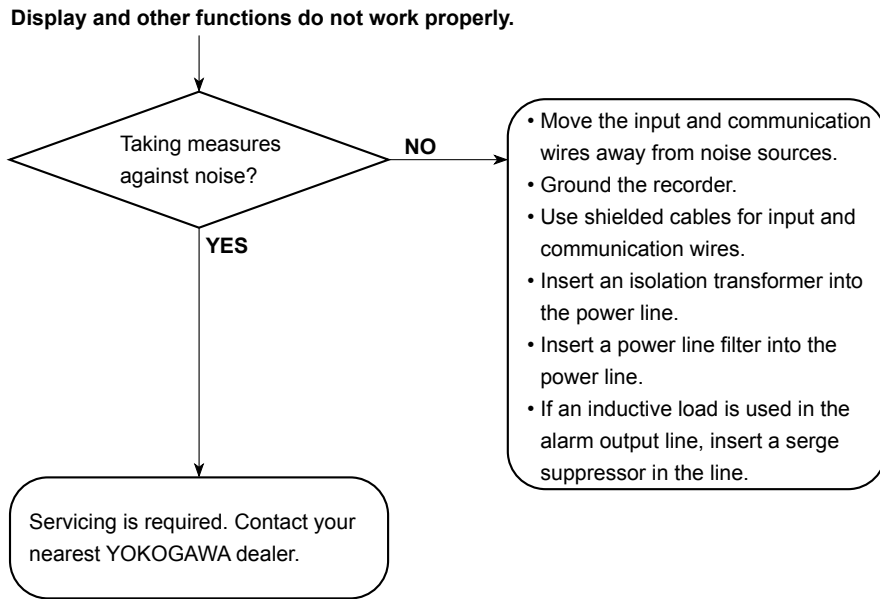

### 5.2.3 Auto restart when a device error occurs (release number 4 (version R4.04) and later)

If an FPGA error or other device error occurs, the system is automatically restarted to prevent erroneous operation.

Data is not acquired during the auto restart procedure. In addition, an auto restart causes the measurement data file being recorded to be divided.

When an auto restart takes place, an error message is displayed or an auto message is written and an e-mail is sent depending on the settings.

- Error message  
When an auto restart takes place, the following error message is displayed.  
“E611 System rebooted due to FPGA software error.”
- Auto message writing  
If recording is in progress, the following message is written automatically when an auto restart takes place.  
“FPGA error Time of occurrence”  
Example: FPGA error 2018/08/31 17:15:30
- E-mail transmission  
If the system error notification is set to ON, an e-mail is sent when an auto restart takes place.
- Measurement data file  
An auto restart causes the measurement data file being recorded to be divided. The Starting Cond. and Dividing Cond. for the division is indicated as “FPGA error.”

Relay output and analog output caused by auto restart

- Fail relay, output relay (DO of DO/DIO modules and PID modules)  
Relays are set to de-energized at auto restart. They return to their normal states when the auto restart is complete.
- Analog output (AO modules)  
Preset action on error takes place during an auto restart. When the auto restart is complete, a power-on preset action takes place, and the output returns to its normal state.
- Analog output (PID modules)  
Relays are set to 0 mA at auto restart. They return to their normal states when the auto restart is complete.

**If the system does not recover with an auto restart or if an auto restart does not take place, contact your nearest YOKOGAWA dealer.**

---

Blank

# Appendix 1 File Size of Display Data and Event Data

This section explains how to calculate the file size of display data files and event data files. The calculation examples are given for the display data only and event data only cases. If you are recording both display and event data, calculate the data size of each and add them together. Use the calculated file size as a rough guide.

The calculations discussed here apply to a GX/GP without the advanced security function (/AS option) or a GX/GP whose advanced security function is disabled.

## File Size

A file consists of the following data.

Information other than the sampled data + the sampled data + system information

The size of system information can range from 1 to 100 KB depending on how the system is configured and other conditions.

The maximum size of a single display data file or event data file when there are no freehand messages is 18 MB. If a file includes freehand messages, the size is in the range of 24 MB to 50 MB.

The file size when there are freehand messages is a reference.

### Size of Information Other Than the Sampled Data

Item	Size (Bytes)
File format identification block	48
File information block	112
Event information block	304
Time zone information block	48
Alarm block	$104 + 56 \times \text{the number of alarms (5000 max)}$
Message block	$72 + 200 \times \text{the number of messages}$
Control information block	$136 + 72 \times \text{number of loops} + 40 \times \text{number of program patterns}$
Control summary block	$104 + 64 \times \text{number of control summaries}$
Control alarm summary block	$104 + 64 \times \text{number of control alarm summaries}$
Batch information block	2360
Display information block	224
Group information block	$24 + 264 \times \text{the number of groups}$
Channel information block	$24 + 328 \times \text{the number of recording channels}$
Calibration correction block	$24 + (40 + 16 \times \text{the number of set point}) \times \text{the number of recording channels (do not include the math channels)}$
Time change information block	280
Measurement data information block	96
Measurement data scan information block	$40 + 16 \times \text{the number of recording channels}$

The number of recording channels is the total of all the channels that are recording.

The number of set points is set unit of channels. (When correction mode is off, the number of set points is zero.)

**Example 1:** When recording data for 30 I/O channels, 10 math channels, 50 communication channels, and 10 group channels. Here we assume that there are no messages, alarms, loops, program patterns, control summaries, or control alarms.

$$\begin{aligned}
 &48 + 112 + 304 + 48 + 104 + 72 + 136 + 104 + 104 + 2360 + 224 + (24 + 264 \times 10) \\
 &+ (24 + 328 \times 90) + (24 + 40 \times 80) + 280 + 96 + (40 + 16 \times 90) \\
 &= 40,904 \text{ bytes}
 \end{aligned}$$

**Sampled Data Size**

- **Data Size of Display Data and Event Data**

Channel	Display Data	Event Data
I/O channel	12 bytes/channel	6 bytes/channel
Math channel	12 bytes/channel	6 bytes/channel
Communication channel	12 bytes/channel	6 bytes/channel

Time data common to all channels is added for each sample.

Time data	16 bytes/sample
-----------	-----------------

- **Data Size per Sample**

**Display Data**

(Number of I/O channels × 12 bytes) + (number of math channels × 12 bytes) + (number of communication channels × 12 bytes) + 16 bytes (time data)

**Event Data**

(Number of I/O channels × 6 bytes) + (number of math channels × 6 bytes) + (number of communication channels × 6 bytes) + 16 bytes (time data)

- **Sampled Data Size per File**

**Display Data**

Data size per sample × **saving interval**/sampling interval

The sampling interval is determined by dividing the **trend interval** (in seconds) by 30 (50 if the trend interval is 5 or 10 s).

**Example 2:** When recording the display data for 30 I/O channels, 10 math channels, and 50 communication channels at a **trend interval** of 30 min/div (the sampling interval of display data is 60 s), and a **saving interval** of 1 day (24 h)

$$\begin{aligned}
 &(30 \times 12 \text{ bytes} + 10 \times 12 \text{ bytes} + 50 \times 12 \text{ bytes} + 16 \text{ bytes}) \times 24 \text{ h} \times 60 \times 60/60 \text{ sec} \\
 &= 1,096 \text{ bytes} \times 24 \text{ h} \times 60 \times 60/60 \text{ sec} \\
 &= 1,578,240 \text{ bytes}
 \end{aligned}$$

**Event Data**

Data size per sample × **data length**/Recording interval

**Example 3:** When recording event data for 30 I/O channels, 10 math channels, 50 communication channels at a **Recording interval** of 1 s and a **data length** of 2 h

$$\begin{aligned}
 &(30 \times 6 \text{ bytes} + 10 \times 6 \text{ bytes} + 50 \times 6 \text{ bytes} + 16 \text{ bytes}) \times 2 \text{ h} \times 60 \times 60/1 \text{ s} \\
 &= 556 \text{ bytes} \times 2 \text{ h} \times 60 \times 60/1 \text{ s} \\
 &= 4,003,200 \text{ bytes}
 \end{aligned}$$

**Size per File**

The size per file is the sum of the size of information other than the sampled data and the size of the sampled data and the size of system information.

**Display Data**

**Example 4:** When recording under the conditions of examples 1 and 2

From examples 1 and 2, we obtain 40,904 + 1,578,240 = 1,619,144 bytes = 1.544 MB  
Then, add the size of system information (about 5 KB in this example).

**Event Data**

**Example 5:** When recording under the conditions of examples 1 and 3

From examples 1 and 3, we obtain 40,904 + 4,003,200 = 4,044,104 bytes = 3.857 MB  
Then, add the size of system information (about 5 KB in this example).

## Save Duration to the SD Memory Card

We will estimate the duration over which measured data can be saved to an SD memory card when measured data is being saved automatically.

### Display Data

Save duration to an SD memory card (estimate) = (Size of the SD memory card/size per file) × [file save interval]

**Example 6:** We will estimate the save duration to an SD memory card under the conditions of examples 1 and 2. In this example, the size of the SD memory card is assumed to be 1 GB.

$$\begin{aligned} &1 \text{ GB}/1.544 \text{ MB} \times 24 \text{ h} \\ &1024 \text{ MB}/1.544 \text{ MB} \times 24 \text{ h} \\ &= 15,915 \text{ h} \\ &= 663 \text{ days} \end{aligned}$$

### Event Data

Save duration to an SD memory card (estimate) = (Size of the SD memory card/size per file) × [data length]

**Example 7:** We will estimate the time until the SD memory card needs to be replaced under the conditions of examples 1 and 3. In this example, the size of the SD memory card is assumed to be 1 GB.

$$\begin{aligned} &1 \text{ GB}/3,857 \text{ MB} \times 2 \text{ h} \\ &1024 \text{ MB}/3,857 \text{ MB} \times 2 \text{ h} \\ &= 531 \text{ h} \\ &= 22.1 \text{ days} \end{aligned}$$

### Note

The available size of an SD memory card is somewhat less than the size indicated.

## Time until the Internal Memory Becomes Full

If you are manually saving the measured data in the internal memory, old data is overwritten when the internal memory is full. The maximum number of files that can be saved to the internal memory is 500. Depending on the file size, files may be overwritten before the internal memory becomes full. You need to save the measured data to the SD memory card before the data is overwritten.

### Display Data

Time until the internal memory becomes full (estimate) = (Size of the internal memory/size per file) × [file save interval]

**Example 8:** We will estimate the time until the internal memory becomes full under the conditions of examples 1 and 2.

The internal memory is standard (500 MB).

$$\begin{aligned} &500 \text{ MB}/1.544 \text{ MB} \times 24 \text{ h} \\ &= 7,771 \text{ h} \\ &= 323 \text{ days} \end{aligned}$$

### Event Data

Time until the internal memory becomes full (estimate) = (Size of the internal memory/size per file) × [data length]

**Example 9:** We will estimate the time until the internal memory becomes full under the conditions of examples 1 and 3.

The internal memory is standard (500 MB).

$$\begin{aligned} &500 \text{ MB}/3,857 \text{ MB} \times 2 \text{ h} \\ &= 259 \text{ h} \\ &= 10.8 \text{ days} \end{aligned}$$

## Appendix 2 Types of Data Files That the GX/GP Can Create and How They Can Be Used

This section will explain the types of data files that the GX/GP can create and how they can be used.

Data Type	Extension	Format	Display Method <sup>1</sup>		
			GX/GP	Viewer	Application
Display data	GDS	Binary (undisclosed)	Yes	Yes	Yes <sup>2, 3</sup>
	GTD	Text format (TSV)	—	—	Yes
Event data	GEV	Binary (undisclosed)	Yes	Yes	Yes <sup>2, 3</sup>
	GTE	Text format (TSV)	—	—	Yes
Report data	GRE	Text (see appendix 3)	—	Yes	Yes
	xlsx	Excel format	—	—	Yes
	xlsm	Excel format (with macro)	—	—	Yes
	pdf	PDF format	—	—	Yes
Manual sampled data	GMN	Text (see appendix 3)	—	Yes	Yes
Setting parameters	GNL	Text	—	—	—
Snapshot data	png	PNG (general format)	—	—	Yes
Alarm summary data	GAL	Text format	—	—	Yes

1 Viewer: Universal Viewer, Application: Software application

2 You can use Universal Viewer to convert the data format and use the converted data on a software application such as Microsoft Excel.

3 You can display data loaded from the GX/GP using the communication function on a software application.



# Appendix 3 Text File Data Format

This section explains the format of text files. The text files that the GX/GP can create are display and event data files (when the data save format is text), manual sample data files, report files, and alarm summary files. Files contain values and character strings, each separated by a tab, in text format.

## Format of Measurement and Event Data Files

### Format

```

YREC
Measure Data      Version 1.01.03
Model             GX10
                  GX20
Language Code     UTF-8
Serial No.        SSS***S
Time Correction    Done
                  None
Sampling Interval NNN***N   ms
                  s
                  min

Trigger Point     NNN***N
Equip Tag         SSS***S
Equip TagNo.      SSS***S
File Header       SSS***S
File ID           NNN***N   NNN***N
Start Info        Unknown   None           SSS***S
                  Manual    Key
                  Auto     Communication
                  Black Out Remote
                  Trigger   Event
End Info          Unknown   None           SSS***S
                  Manual    Key
                  Auto     Communication
                  Black Out Remote
                  Trigger   Event
Extra Data        Meas     Max           PlusOver   NNN***N   ...
                  Math     Min           MinusOver
                  Ext     Inst
Time Zone         NNN***N
DST               On       January      FirstWeek   Sunday      NNN***N   January   FirstWeek   Sunday      NNN***N   NNN***N
                  Off      February     SecondWeek  Monday
                  March     ThirdWeek   Tuesday
                  April     FourthWeek  Wednesday
                  May       LastWeek    Thursday
                  June     Friday
                  July     Saturday
                  August
                  September
                  October
                  November
                  December

Batch Info        NNN***N   SSS***S
Batch Comment     TTT***T   SSS***S           SSS***S
Batch Comment     TTT***T   SSS***S           SSS***S
Batch Comment     TTT***T   SSS***S           SSS***S
Text Info
Text Field        SSS***S   SSS***S
Text Field        SSS***S   SSS***S
Text Field        SSS***S   SSS***S
:                 :           :
Text Field        SSS***S   SSS***S
Ch                SSS***S   SSS***S           ...           Message
Ch Id             SSS***S   SSS***S           ...
Tag               SSS***S   SSS***S           ...
Unit              SSS***S   SSS***S           ...
Type              Meas     Meas           ...           Message
                  Math     Math           ...
                  Ext     Ext           ...

```

Continued on next page

**Appendix 3 Text File Data Format**

Kind	Inst	Inst	...
	Min	Min	...
	Max	Max	...
Sampling Data			
TTT...T	NNN...N	NNN...N	NNN...N ...
Message Data			
TTT...T	SSS...S	None	SSS...S
		Key	
		Communication	
		Remote	
		Event	
		System	
		Serial	

NNN...N: Value  
 SSS...S: Character string  
 TTT...T: Date and time

Common header	YREC	Fixed character string
Format header	Measure Data	File type
	Model	Model name
	Language	-
Information header section	Serial No.	Serial number (up to 16 characters)
	Time Correction	Time change information
	Sampling Interval	Sampling interval
	Trigger Point	Trigger point: 0 and higher
	Equip Tag	Equipment tag (up to 32 characters)
	Equip TagNo.	Equipment tag number (up to 16 characters)
	File Header	File header (up to 50 characters)
	File ID	First: Record start number Second: File serial number up to record stop
	Start Info	Start user name (up to 20 characters)
	End Info	End user name (up to 20 characters)
	Extra Data	-
	Time Zone	Current time zone setting
	DST	Current DST setting
	Batch Info	Lot number: 0 and higher Batch number (up to 32 characters) The entire block is omitted when batch is set to off.
	Batch Comment	User name (up to 20 characters), comment (up to 50 characters)
Text Info	The entire block is omitted when batch is set to off.	
Text Field	Title (up to 20 characters), text (up to 30 characters)	
Table header section	Ch	Channel number (up to 4 characters) The character string "Message" is inserted at the right end.
	Ch Id	Tag number (up to 16 characters, spaces on the right)
	Tag	Tag name (up to 32 characters, spaces on the right)
	Unit	Unit name (up to 6 characters, spaces on the right)
	Type	The character string "Message" is inserted at the right end.
Kind	The character string "Count" is inserted at the right end.	
Measured data block	Sampling Data	The number of messages (up to 4 characters) is inserted in the right most column.
Message data block	Message Data	Message string (up to 32 characters), user name (up to 20 characters) If the number of messages is zero, the entire block is omitted. For freehand messages, the message string is **FreehandMessage*.

**File Output Example**  
**• Display Data**

```

YREC
Measure Data      Version 1.01.03
Model             GX20
Language Code     UTF-8
Serial No.        S5E701635
Time Correction    None
Sampling Interval 1          s
Trigger Point     4
Equip Tag         tag
Equip TagNo.      tagno
File Header       FILE_HEADER_STRING
File ID           34295620394
Start Info        Auto          Key          Admin
End Info          Auto          Key          Admin
Extra Data        Meas          Max          PlusOver    999999999  MinusOver   -999999999
Extra Data        Meas          Min          PlusOver    999999999  MinusOver   -999999999
Extra Data        Math          Max          PlusOver    999999999  MinusOver   -999999999
Extra Data        Math          Min          PlusOver    999999999  MinusOver   -999999999
Extra Data        Ext          Max          PlusOver    999999999  MinusOver   -999999999
Extra Data        Ext          Min          PlusOver    999999999  MinusOver   -999999999
Time Zone         540
DST               On          March       SecondWeek  Sunday      2          November   FirstWeek  Sunday      2          -60
Batch Info        000002     batch-name-no.
Batch Comment     2013/04/06 14:50:00  Admin1     comment1
Batch Comment     2013/04/06 14:50:00  Admin1     comment2
Batch Comment     2013/04/06 14:50:00  Admin1     comment3

Text Info
Text Field        title1       text1
Text Field        title2       text2
Text Field        title3       text3
Text Field        title4       text4
Text Field        title5       text5
Text Field        title6       text6
Text Field        title7       text7
Text Field        title8       text8
Text Field        title9       text9
Text Field        title10      text10
Text Field        title11      text11
Text Field        title12      text12
Text Field        title13      text13
Text Field        title14      text14
Text Field        title15      text15
Text Field        title16      text16
Text Field        title17      text17
Text Field        title18      text18
Text Field        title19      text19
Text Field        title20      text20
Text Field        title21      text21
Text Field        title22      text22
Text Field        title23      text23
Text Field        title24      text24
Ch                0001        0001        A001        A001        C002        C002        Message
Ch Id             TagID_001   TagID_001   TagID_002   TagID_002   TagID_003   TagID_003
Tag               Furnace 1   Furnace 1   Furnace 2   Furnace 2   Furnace 3   Furnace 3
Unit              °C          °C          °C          °C          °C          °C
Type              Meas        Meas        Math        Math        Ext         Ext         Message
Kind              Min         Max         Min         Max         Min         Max         Count

Sampling Data
2013/04/06 14:50:00 153.2      153.3      153.2      153.3      153.2      153.3      1
2013/04/06 14:50:01 153.3      153.4      153.3      153.4      153.3      153.4      0
2013/04/06 14:50:02 153.4      153.5      153.4      153.5      153.4      153.5      2
2013/04/06 14:50:03 153.5      153.6      153.5      153.6      153.5      153.6      0
2013/04/06 14:50:04 153.6      153.7      153.6      153.7      153.6      153.7      0

Message Data
2013/04/06 14:50:00 Message 1   Key          Admin1
2013/04/06 14:50:02 Message 2   Communication Admin2
2013/04/06 14:50:02 *Freehand Message* Key          Admin3
    
```

**Appendix 3 Text File Data Format**

• **Event Data**

```

YREC
Measure Data          Version 1.01.03
Model                 GX20
Language Code         UTF-8
Serial No.            S5E701635
Time Correction        None
Sampling Interval     500                ms
Trigger Point         4
Equip Tag             tag
Equip TagNo.          tagno
File Header           FILE_HEADER_STRING
File ID               6893290432
Start Info            Auto                Key          Admin
End Info              Auto                Key          Admin
Extra Data            Meas                Inst          PlusOver    999999999 MinusOver -999999999
Extra Data            Math                Inst          PlusOver    999999999 MinusOver -999999999
Extra Data            Ext                 Inst          PlusOver    999999999 MinusOver -999999999
Time Zone             540
DST                   On                March         SecondWeek  Sunday    2          November   FirstWeek  Sunday 2   -60
Ch                    0001              0002          0101       0102      Message
Ch Id                 TagID_001         TagID_002     TagID_003  TagID_004
Tag                   Furnace 1         Furnace 2     Furnace 3   Furnace 4
Unit                  °C                °C            °C          °C
Type                  Meas              Meas          Meas        Meas      Message
Kind                  Inst              Inst          Inst        Inst      Count

Sampling Data
2013/04/06 14:50:00_000 153.2          153.3        153.2      153.3     1
2013/04/06 14:50:00_500 153.3          153.4        153.3      153.4     0
2013/04/06 14:50:01_000 153.4          153.5        153.4      153.5     2
2013/04/06 14:50:01_500 153.5          153.6        153.5      153.6     0
2013/04/06 14:50:02_000 153.6          153.7        153.6      153.7     0

Message Data
2013/04/06 14:50:00_000 Message 1      Key          Admin1
2013/04/06 14:50:01_000 Message 2      Communication Admin2
2013/04/06 14:50:01_000 *Freehand Message* Key          Admin3
    
```

### Format of Manual Sample Data Files

- Manual sample data files contain values and character strings, each separated by a tab, in text format.
- Values of I/O channels set to **Skip** and math and communication channels set to **Off** are not output.
- The data is appended to the file each time manual sample operation is performed.

#### Format

```

YREC
Manual Sample Data Version 1.04.00
Language Code      UTF-8
Model              GX10
                  GX20
File Status        Complete
                  Progress
                  Decrease
Serial No.         SSS...S
Equip Tag          SSS...S
Equip TagNo.       SSS...S
File Header        SSS...S
Extra Data         (omitted)
Time Zone          NNN...N
DST                On
                  Off
                  January FirstWeek Sunday NNN...N January FirstWeek Sunday NNN...N NNN...N
                  February SecondWeek Monday February SecondWeek Monday
                  March ThirdWeek Tuesday March ThirdWeek Tuesday
                  April FourthWeek Wednesday April FourthWeek Wednesday
                  May LastWeek Thursday May LastWeek Thursday
                  June Friday Friday
                  July Saturday July Saturday
                  August
                  September September
                  October October
                  November November
                  December December
Ch                SSS...S ...
Ch Id              SSS...S ...
Tag                SSS...S ...
Unit               SSS...S ...
TTT...T           NNN...N ...
    
```

NNN...N: Value  
 SSS...S: Character string  
 TTT...T: Date and time

#### File Output Example

```

YREC
Manual Sample Data Version 1.04.00
Language Code      UTF-8
Model              GX20
File Status        Progress
Serial No.         S5KC09223
Equip Tag          tag
Equip TagNo.       tagno
File Header
Extra Data         Inst      PlusOver  999999999  MinusOver  -999999999
Time Zone          540
DST                On      February  SecondWeek  Sunday    20      September  ThirdWeek  20      -60
Ch                0001    0002    0003    0004    0005    0006    0007    0008
Ch Id              chid001001 chid001002 chid001003 chid001004 chid001005 chid001006 chid001007 chid001008
Tag
Unit               V      V      V      V      V      V      V      V
2012/12/12 14:50:01 0      0      -0.0001 -0.0003 -0.0005 -0.0007 -0.0009 -0.0002
2012/12/12 14:51:01 0      0      -0.0002 -0.0004 -0.0006 -0.0008 -0.0001 -0.0003
    
```

**Note**

- File status  
 Complete: Completed. (100 manual sample data entries have been stored, and the file is closed.)  
 Progress: Data is being added. (The number of stored data entries has not reached 100 files, and the file is open.)  
 Decrease: Corrupted. (Some of the manual sample data in the file are missing.)
- Output when channel data is in the condition shown in the table below

Data Condition	Data Handling	Output
Error	Error	(Space)
+Overrange	+Over	Value indicated for PlusOver in the Extra Data information header section
+Burnout		
+Display over		
+Computation over		
-Overrange	-Over	Value indicated for MinusOver in the Extra Data information header section
-Burnout		
-Display over		
-Computation over		

- A new manual sampled data file is created in the following cases.
- The range of an I/O channel configured as a manual sampling recording channel was changed from some range other than Skip to Skip.
- The range of an I/O channel configured as a manual sampling recording channel was changed from Skip to some range other than Skip.
- A math or communication channel configured as a manual sampling recording channel was changed from On to Off or from Off to On.
- The unit of a channel configured as a manual sampling recording channel was changed.
- When the settings of a manual sampling recording channel are changed.
- When an AI channel configured as a manual sampling recording channel is changed from the DI range (calculation is not set to linear scaling) to some other range, or vice versa.
- When a DI channel configured as a manual sampling recording channel is changed from linear scaling calculation to some other setting, or vice versa.
- When the decimal place of a channel configured as a manual sampling recording channel is changed.

### Report File Format (/MT option)

- Hourly, daily, weekly, and monthly report files contain values and character strings, each separated by a tab, in text format.
- Values of I/O channels set to **Skip** and math and communication channels set to **Off** are not output.
- The data is appended to this file every time a report is created.

#### Format

YREC											
Report Data	Version										
	1.05.00										
Language Code	UTF-8										
Model	GX10										
	GX20										
File Statas	Complete										
	Progress										
	Decrease										
Serial No.	SSS•••S										
Equip Tag	SSS•••S										
Equip TagNo.	SSS•••S										
File Header	SSS•••S										
Extra Data	(omitted)	Ave	PlusOver	NNN•••N	MinusOver	NNN•••N					
		Max									
		Min									
		Sum									
		Inst									
Report Set	Hourly+Daily										
	Daily+Weekly										
	Daily+Monthly										
	Batch										
	DailyCustom										
File Data	Hourly										
	Daily										
	Weekly										
	Monthly										
	Hourly+Daily										
	Daily+Weekly										
	Daily+Monthly										
	Batch										
	DailyCustom										
Math Set	Ave	•••									
	Max										
	Min										
	Sum										
	Inst										
Start Time	TTT•••T										
Time Zone	NNN•••N										
DST	On	January	FirstWeek	Sunday	NNN•••N	January	FirstWeek	Sunday	NNN•••N	NNN•••N	
	Off	February	SecondWeek	Monday		February	SecondWeek	Monday			
		March	ThirdWeek	Tuesday		March	ThirdWeek	Tuesday			
		April	FourthWeek	Wednesday		April	FourthWeek	Wednesday			
		May	LastWeek	Thursday		May	LastWeek	Thursday			
		June		Friday		June		Friday			
		July		Saturday		July		Saturday			
		August				August					
		September				September					
		October				October					
		November				November					
		December				December					
Ch	SSS•••S	•••									
Ch Id	SSS•••S	•••									
Tag	SSS•••S	•••									
Unit	SSS•••S	•••									
Data Type	Free										
	Hourly										
	Daily										
	Weekly										
	Monthly										
	Batch										
	DailyCustom										

Continued on next page

**Appendix 3 Text File Data Format**

```

Time                TTT...T

Elapsed Time1      (omitted)          TTT...T
Status              ...
                   Er
                   Ov
                   Pw
                   Cg
(Data attribute     NNN...N          ...
identifier)
Batch Info Data    NNN...N          SSS...S
Batch Comment      TTT...T          SSS...S  SSS...S
Batch Comment      TTT...T          SSS...S  SSS...S
Batch Comment      TTT...T          SSS...S  SSS...S
Text Info Data
Text Field         SSS...S          SSS...S
:                 :
Text Field         SSS...S          SSS...S
    
```

NNN...N: Value  
 SSS...S: Character string  
 TTT...T: Date and time  
 1 Elapsed time is used for batch reports.

**Output Example**

- Hourly (hourly + daily) recording with file set to Separate

```

YREC
Report Data      Version 1.05.00
Language Code    UTF-8
Model           GX20
File Statu      Complete
Serial No.      S5KC09223
Equip Tag       tag
Equip TagNo.    tagno
File Header
Extra Data      Ave          PlusOver  999999999  MinusOver -999999999
Extra Data      Max          PlusOver  999999999  MinusOver -999999999
Extra Data      Min          PlusOver  999999999  MinusOver -999999999
Extra Data      Inst        PlusOver  999999999  MinusOver -999999999
Report Set      Hourly+Daily
File Data       Hourly
Math Set        Ave          Max          Min          Sum
Start Time      2012/12/12 11:01:01
Time Zone       540
DST             On          February    SecondWeek  Sunday      20          September   ThirdWeek   20          -60
Ch              0001       0002       0003       0004       A001       A002       A003       C001
Ch Id           chid001001 chid001002 chid001003 chid001004 chid001005 chid001006 chid001007 chid001008
Tag             Point A     Point B     Point C     Point D     Point A Math Point B Math Point C Math Com
Unit           V          V          V          V          °C         °C         °C         V
Data Type       Hourly
Time            2012/12/12 12:00:00
Status
Ave             0.0001     0.5010     0.7397     -1.0001    122.6      20.08      -20.98     0.2001
Max             1.9983     0.9989     1.4995     0.0010    123.4      22.02      -20.01     0.8887
Min             -1.9959    -0.0053    -0.1005    -1.9952    120.3      19.79      -24.00     -0.3345
Sum             0.353900E+00 1.773039E+03 2.617798E+03 -3.53935E-03 4.338814E+05 7.099234E+04 -7.424822E-04 7.081539E+02
Data Type       Hourly
Time            2012/12/12 12:06:01
Status
Ave             0.0002     0.5011     0.3301     -1.4423    121.3      20.20      -21.21     0.4411
Max             1.9984     0.9990     1.4995     0.0001    122.4      21.98      -20.95     0.8898
Min             -1.9959    -0.0055    -1.4005    -1.994     120.09     19.00      -22.22     -0.1121
Sum             0.072200E+00 1.808971E+02 1.191661E+02 -5.206703E-02 4.378930E+04 7.292200E+03 -7.656810E-03 1.592371E+02
Batch Info      000002
Data
Batch Comment   2015/10/22 Admin1     comment1
                14:50:00
Batch Comment   2015/10/22 Admin1     commnet2
                14:50:00
Batch Comment   2015/10/22 Admin1     comment3
                14:50:00
    
```

Continued on next page



```
Text Info
Data
Text Field title1 text1
Text Field title2 text2
Text Field title3 text3
Text Field title4 text4
Text Field title5 text5
Text Field title6 text6
Text Field title7 text7
Text Field title8 text8
Text Field title9 text9
Text Field title10 text10
Text Field title11 text11
Text Field title12 text12
Text Field title13 text13
Text Field title14 text14
Text Field title15 text15
Text Field title16 text16
Text Field title17 text17
Text Field title18 text18
Text Field title19 text19
Text Field title20 text20
Text Field title21 text21
Text Field title22 text22
Text Field title23 text23
Text Field title24 text24
```

• Batch Report

```
YREC
Report Data Version 1.05.00
Language Code UTF-8
Model GX20
File Status Complete
Serial No. S5KC09223
Equip Tag tag
Equip TagNo. tagno
File Header
Extra Data Ave PlusOver 999999999 MinusOver -999999999
Extra Data Max PlusOver 999999999 MinusOver -999999999
Extra Data Min PlusOver 999999999 MinusOver -999999999
Extra Data Inst PlusOver 999999999 MinusOver -999999999
Report Set Batch
File Data Batch
Math Set Ave Max Min Sum
Start Time 2012/12/12 11:01:01
Time Zone 540
DST On February SecondWeek Sunday 20 September ThirdWeek 20 -60
Ch 0001 0002 0003 0004 A001 A002 A003 C001
Ch Id chid001001 chid001002 chid001003 chid001004 chid001005 chid001006 chid001007 chid001008
Tag
Unit V V V V °C °C °C °C
Data Type Batch
Elapsed Time 0000 00:10:00
Status
Ave 0.0001 0.5010 0.7397 -1.0001 122.6 20.08 -20.98 0.2001
Max 1.9983 0.9989 1.4995 0.0010 123.4 22.02 -20.01 0.8887
Min -1.9983 -0.0033 -0.1005 -1.9952 120.3 19.79 -24.00 -0.3345
Sum 6.000000E-02 3.006000E+02 4.438200E+02 -6.000600E+02 7.356000E+04 1.204800E+04 -1.258800E+04 1.206000E+02
Data Type Batch
Elapsed Time 0000 00:15:30
Status
Ave 0.0021 0.5110 0.7362 -1.0005 98.5 20.51 -20.42 0.1999
Max 1.9950 0.9987 1.4991 0.0011 105.2 21.01 -19.99 0.8802
Min -1.9989 -0.0053 -0.0997 -1.9960 70.5 20.01 -23.89 -0.3321
Sum 6.930000E+00 1.818300E+02 2.429460E+02 3.301650E+02 3.250500E+04 6.768300E+03 -6.738600E+03 6.596700E+01
Data Type Free
Elapsed Time 0000 00:15:30
Status
Ave 0.0008 0.5187 0.7374 -1.0002 114.0 20.23 -20.78 0.2000
Max 1.9950 0.9989 1.4995 0.0011 123.4 22.02 -19.99 0.8887
Min -1.9989 -0.0053 -0.1005 -1.9952 70.5 19.79 -24.00 -0.3345
Sum 7.530000E-01 4.824300E+02 6.858210E+02 -9.302250E+02 1.060650E+05 1.881630E+04 -1.932660E+04 1.860270E+02
```

Continued on next page

### Appendix 3 Text File Data Format

---

```
Batch Info      000002
Data
Batch Comment  2015/10/22  Admin1      comment1
                14:50:00
Batch Comment  2015/10/22  Admin1      commnet2
                14:50:00
Batch Comment  2015/10/22  Admin1      comment3
                14:50:00

Text Info
Data
Text Field    title1      text1
Text Field    title2      text2
Text Field    title3      text3
Text Field    title4      text4
Text Field    title5      text5
Text Field    title6      text6
Text Field    title7      text7
Text Field    title8      text8
Text Field    title9      text9
Text Field    title10     text10
Text Field    title11     text11
Text Field    title12     text12
Text Field    title13     text13
Text Field    title14     text14
Text Field    title15     text15
Text Field    title16     text16
Text Field    title17     text17
Text Field    title18     text18
Text Field    title19     text19
Text Field    title20     text20
Text Field    title21     text21
Text Field    title22     text22
Text Field    title23     text23
Text Field    title23     text24
```



## Alarm Summary Format

- Files contain values and character strings, each separated by a tab, in text format.
- Values of I/O channels set to **Skip** and math and communication channels set to **Off** are not output.

### Format

```

YREC
Alarm Summary Data Version 1.01.00
Language Code      UTF-8
Model              GX10
                  GX20
Serial No.         SSS...S
Equip Tag          SSS...S
Equip TagNo.       SSS...S
File Header        SSS...S
Time Zone          NNN...N
DST                On      January      FirstWeek  Sunday    NNN...N  January      FirstWeek  Sunday    NNN...N  NNN...N
                  Off      February     SecondWeek Monday     February     SecondWeek Monday
                  March      ThirdWeek  Tuesday   March      ThirdWeek  Tuesday
                  April      FourthWeek Wednesday April      FourthWeek Wednesday
                  May        LastWeek   Thursday  May        LastWeek   Thursday
                  June       Friday     June       Friday
                  July        Saturday   July       Saturday
                  August
                  September
                  October
                  November
                  December

Alarm Data
TTT...T           On      SSS...S    SSS...S    SSS...S
                  Off
                  Ack
    
```

NNN...N: Value  
 SSS...S: Character string  
 TTT...T: Date and time

### Output Example

```

YREC
Alarm Summary Data Version 1.01.00
Language Code      UTF-8
Model              GX20
Serial No.         S5KC09223
Equip Tag          tag
Equip TagNo.       tagno
File Header
Time Zone          540
DST                On      February     SecondWeek Sunday    20      September  ThirdWeek  20      -60

Alarm Data
2012/12/12 11:01:10 On      0001        1          H
2012/12/12 11:01:12 Off     0001        1          H
2012/12/12 11:01:14 Ack     All
    
```

# Appendix 4 Creating Report Templates

## Creating Report Templates for Report Files in Excel Format

To create a report template, enter keywords and text in the cells of an Excel file. Keywords specify the type of data that will be entered into a cell. Text are output as they are in reports. Save the report templates that you create in Excel format (.xlsx extension) or Excel macro format (.xlsm extension).

- ▶ Function: See page 1-156 in section 1.17, "Using the Report Template Function (/MT option)".
- ▶ Setup: See page 1-151 in section 1.16, "Configuring the Report Function (/MT option)".
- ▶ Loading and saving report templates: See page 1-158 in section 1.17.5, "Loading and Saving Report Template Files".

### Template Example

<b>Channel number</b>	<b>\$Tag(R001)\$</b>	<b>\$Tag(R002)\$</b>
<b>Name</b>	<b>Tank 1 temperature</b>	<b>Tank 1 pressure</b>
<b>Unit</b>	<b>\$Unit(R001)\$</b>	<b>\$Unit(R002)\$</b>
<b>\$ReportDataTime(Hour)\$</b>	<b>\$ReportDataInst(Hour, R001)\$</b>	<b>\$ReportDataInst(Hour, R002)\$</b>
<b>\$Repeat\$</b>	<b>\$Repeat\$</b>	<b>\$Repeat\$</b>
<b>\$Repeat\$</b>	<b>\$Repeat\$</b>	<b>\$Repeat\$</b>

### Report Output Example

<b>Channel number</b>	<b>TIC-001</b>	<b>PIC-002</b>
<b>Name</b>	<b>Tank 1 temperature</b>	<b>Tank 1 pressure</b>
<b>Unit</b>	<b>°C</b>	<b>kPa</b>
2012/12/01 00:00:00	76.5	45.6
2012/12/01 01:00:00	78.9	56.7
2012/12/01 02:00:00	77.7	50.8

**Keyword Format**

Keywords are written by themselves or with parameters.

\$ Keyword(parameter)\$ Example: \$ReportDataSum(Hour,R001,00,23)\$

**Basic Rules**

- The dollar sign on the left indicates the start of a keyword, and the dollar sign on the right indicates the end of a keyword.
- You can only write keywords using letters of the alphabet, dollar signs, parentheses, commas, and spaces. You can put a space after an opening parenthesis, before and after a comma, and before a closing parenthesis. Keywords are not case sensitive. You cannot use a dollar sign inside of a keyword.
- The maximum length of a keyword, including spaces, is 100 characters.

**Parameter Rules**

- Parameters are enclosed in parentheses.
- Multiple parameters (up to 4) are separated by commas.
- Examples of how parameters can be omitted are shown below.

\$ReportDataSum(Hour, R001, ,23)\$ The third parameter has been omitted.  
\$ReportDataSum(Hour, R001, 01, )\$ or The fourth parameter has been omitted.  
\$ReportDataSum(Hour, R001, 01)\$

**Excel Format Rules**

- Set the data format by setting the cell format.
- Set the proper format for each keyword's cell in the cell's Number properties.
- The keyword in a cell is only valid when the keyword name and parameters are all in the same format. When a keyword's font size or some other property is not consistent, it is invalid.

\$ReportDataSum(Hour, R001, 00, 23)\$ The font size of "Hour" is different, so the keyword is invalid.

- If a single cell contains text and a keyword, only the format of the keyword has to be consistent. The format of the text can be different.

Date and time: \$DateTimes\$ The format of the keyword is consistent, so it is valid.

**Limitations on Report Types and Template Types**

If you violate the rules illustrated below, data will not be output.

Keyword Parameter	Template Type								
	Hour	Day	Week	Month	Hour + Day	Day + Week	Day + Month	Batch	Day Custom
Hour	✓				✓				
Day		✓			✓	✓	✓		
Week			✓			✓			
Month				✓			✓		
Batch								✓	
Custom									✓
Free								✓	✓

**Limitation on Report Types and Parameter Omissions**

If you violate the rules illustrated below, it will be considered a keyword format error. The keyword will not be converted and will remain as is.

Report Kind	Start date and time	End date and time	Start number	End number
Hour	Start time (hour)	End time (hour)	—	—
Day	Start day	End day	—	—
Week	—	—	—	—
Month	—	—	—	—
Batch	Relative start time (minute)	Relative end time (minute)	Start number	End number
Custom	Start time (hour:minute)	End time (hour:minute)	—	—
Free	—	—	—	—

## Keyword Definitions

For examples, see “Report Template Examples.”

### • System Keywords

One keyword produces one item of data.

Keyword	Description	Format
Time	Current time on the GX/GP	Time <sup>2</sup>
Date	Current date on the GX/GP	Date <sup>2</sup>
DateTime	Current date and time on the GX/GP	
DateTimeString	Current date and time on the GX/GP	Character string
Serial	GX/GP serial number	
Equip tag	GX/GP Tag string	
EquipTagNo	GX/GP Tag number	
FileHeader	GX/GP file header <sup>3</sup>	
Ch	Channel number <sup>1</sup>	
Tag	Tag string <sup>1</sup>	
ChId	Tag number <sup>1</sup>	
Unit	Unit <sup>1</sup>	

- 1 The parameter is the report channel number (it cannot be omitted).
- 2 The item becomes a character string in PDF and printer output.
- 3 If the multi-batch function (/BT option) is enabled, the file header set in batch group number 1 is always displayed.

### • Report Data Keywords

One keyword produces multiple items of data.

Keyword	Description	Format
ReportDataDate	Report creation date <sup>1</sup>	Date <sup>5</sup>
ReportDataTime	Report creation time <sup>1</sup>	Time <sup>5</sup>
ReportDataDateTime	Report creation date and time <sup>1</sup>	Date <sup>5</sup>
ReportDataDateTimeString	Report creation date and time <sup>1</sup>	Character string
ReportDataElapsedTimeString <sup>4</sup>	Report data time out date and time (Relative time since the start of recording)	
ReportDataStatus	Report data status <sup>2</sup>	
ReportDataSum	Report data sum <sup>2</sup>	Number or character string <sup>3</sup>
ReportDataInst	Instantaneous report data value <sup>2</sup>	
ReportDataAve	Average report data value <sup>2</sup>	
ReportDataMax	Maximum report data value <sup>2</sup>	
ReportDataMin	Minimum report data value <sup>2</sup>	

- 1 Write the parameters in this order: report type (cannot be omitted), report start date and time (can be omitted), report end date, time (can be omitted), start number (can be omitted), and end number (can be omitted).
- 2 Write the parameters in this order: report type (cannot be omitted), report channel number (cannot be omitted), report start date and time (can be omitted), report end date and time (can be omitted), start number (can be omitted), and end number (can be omitted).
- 3 The decimal point type (dot or comma) depends on whether the converted data is a value or character string. Whether the converted data is a value or character string depends on the format of the cell that the keyword is written in. When the cell format is numerical, the decimal point type is determined by the cell format. When the cell format is text, the decimal point type matches the format of the report data.
- 4 Valid only when the report type is **Batch**.
- 5 The item becomes a character string in PDF and printer output.

### • Special Keywords

Keyword	Description	Format
Repeat	Specifies the output location of the data that corresponds the report data keyword and the Index keyword (a special keyword).	The same as the corresponding keyword.
Copy	Outputs all data that corresponds the report data keyword and the Index keyword (a special keyword). This keyword is valid for PDF and printer output.	The same as the corresponding keyword.
Index	Outputs serial numbers from the value specified by “start” to the value specified by “end.”	Number

**Appendix 4 Creating Report Templates**

• **Parameters**

Parameter Name	Format	Range	Description	Notes
Report channel number	Rxxx <sup>1</sup>	GX20/GP20: R01 to R60 GX10/GP10: R01 to R50	GX/GP report channel	
Report kind	Hour	–	Hourly report	
	Day	–	Daily report	
	Week	–	Weekly report	
	Month	–	Monthly report	
	Batch	–	Batch report	
	Custom	–	Daily custom	
	Free	–	Batch and daily custom reports Computed results, such as sum values, of data in the file are appended to the file. This piece of data is called "Free."	
Start date and time	hh <sup>2</sup>	00 to 23	Specifies the start hour	Used in hourly reports
	dd <sup>3</sup>	01 to 31	Specifies the start day	Used in daily reports
	mm <sup>4</sup>	0 to 12000	Specify the start minute	Used in batch reports
	hh:mm <sup>5</sup>	hh: 00 to 23 mm: 00 to 59	Specifies the start hour:time	Used in hourly custom reports
End date and time	hh <sup>2</sup>	00 to 23	Specifies the end hour	Used in hourly reports
	dd <sup>3</sup>	01 to 31	Specifies the end day	Used in daily reports
	mm <sup>4</sup>	0 to 12000	Specify the end minute	Used in batch reports
	hh:mm <sup>5</sup>	hh: 00 to 23 mm: 00 to 59	Specifies the end hour:minute	Used in hourly custom reports
Start number	xxx <sup>1</sup>	001 to 200	Specifies the start number	Used in batch reports
End number	xxx <sup>1</sup>	001 to 200	Specifies the end number	Used in batch reports

- 1 xxx is a number without a limitation on the number of digits
- 2 hh is a number without a limitation on the number of digits
- 3 dd is a number without a limitation on the number of digits
- 4 mm is a number without a limitation on the number of digits
- 5 Spaces are allowed before and after colons.
- 6 Start time and end time are relative to the record start time.



### Starting and Ending Dates and Times

Use the start date and time and end date and time to specify the parts of the report file's report data that you will output to the file that you create with the template. You can specify the starting and ending dates (for daily reports) or times (for hourly reports).

Report Kind	Start Date and Time	End Date and Time
Hour	Start time (hour)	End time (hour)
Day	Start time (day)	End time (day)
Batch	Start time (minute)	End time (minute)
Day custom	Start time (hour:minute)	End time (hour:minute)

Example when the report type is hourly and the report is created at 18:00.

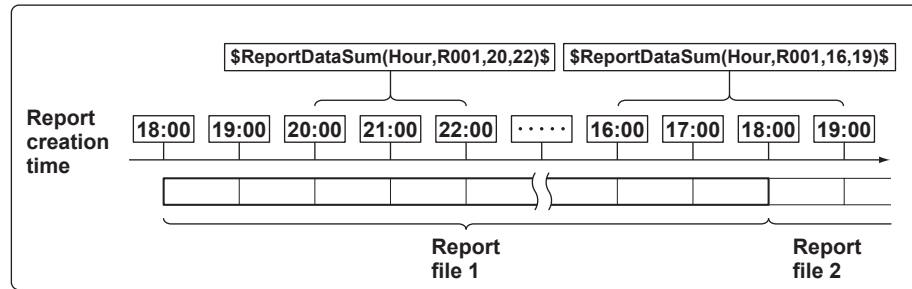

**Keyword: \$ReportDataSum(Hour,R001,20,22)\$**

From the hourly data from 19:00:01 to 22:00:00, the report data (sums) of report channel R001 for 20:00, 21:00, and 22:00 is output.

**Keyword: \$ReportDataSum(Hour,R001,16,19)\$**

From the hourly data from 15:00:01 to 19:00:00, the report data (sums) of report channel R001 for 16:00, 17:00, and 18:00 is output. Because the report data for 19:00 is in another report file, it is not output.

**Keyword: \$ReportDataSum(Hour,R001)\$**

One file's worth (18:00:01 to 18:00:00) of data from report channel R001 is output, starting from 19:00.

When you omit the start and end times for an hourly report, the data for the hour after the report creation time until the 24th hour is output. For daily reports, the data for the day after the report creation time until the end of the month is output.

**Keyword: \$ReportDataSum(Hour,R001,08)\$**

From the hourly data from 07:00:01 to 18:00:00, the report data (sums) of report channel R001 for 08:00 to 18:00 is output.

## Report Template Examples

### System Keyword Examples

#### Intermixed Keyword and Text

File header: \$FileHeader\$			
Date and time: \$DateTime\$			
File header: GX20			
Date and time: 2012/12/01 12:00:00			

#### Intermixed Multiple Keyword and Text

Device number: \$Serial\$ File Header: \$FileHeader\$			
Device number: ABCDEFG File Header: GX20			

### Report Data Keyword Examples

The following examples are for when the hourly report data for report channel R001 is 101, 102, 103, 104, and 105 and the hourly report data for report channel R002 is 201, 202, 203, 204, 205, and 206.

The \$Repeat\$ command applies to the closest keyword above the command in the same column.

\$ReportDataInst(Hour,R001)\$		101	
\$Repeat\$		102	
\$Repeat\$		103	
\$Repeat\$		104	
\$ReportDataInst(Hour,R002)\$		201	
\$Repeat\$		202	
\$Repeat\$		203	
\$Repeat\$		204	
\$Repeat\$		205	

The \$Repeat\$ command applies to the keyword above it in the same column, even when that keyword is not directly above the command.

\$ReportDataInst(Hour,R001)\$		101	
\$Unit(R001)\$		°C	
\$Repeat\$		102	
\$Unit(R001)\$		°C	
\$Repeat\$	\$Unit(R001)\$	103	°C

You can mix system keywords, report data keywords, and text. If the data specified by a keyword does not exist, nothing is output.

\$ReportDataInst(Hour,R001)\$(\$Unit(R001)\$)		101 (°C)	
\$Repeat\$		102	
\$Repeat\$		103	
\$Repeat\$(\$Unit(R001)\$)		104 (°C)	
\$Repeat\$(°C)		105 (°C)	
\$Repeat\$			

Keywords in merged cells are affected by the leftmost cells above them.

	\$ReportDataInst(Hour,R001)\$	\$ReportDataInst(Hour,R002)\$	
	\$Repeat\$	\$Repeat\$	
\$Repeat\$		\$Repeat\$	
	\$Repeat\$	\$Repeat\$	
	↓		
	101	201	
	102	202	
		203	
	103	204	

When a keyword is written incorrectly or its formatting is wrong, the keyword will be output to the file as it is written.

\$ReportDataInst(Hour,R)\$	\$ReportDataInst(Hour,R)\$
	201
\$ReportDataInst(Hour,R002)\$	\$Repeat\$
\$Repeat\$	202
\$Repeat\$	203
\$Repeat\$	204
\$ReportDataInst(Hour,R001)\$	101
\$ReportDataInst(Hour,R002)\$	\$ReportDataInst(Hour,R002)\$

1 When there are multiple system keywords in the same cell, only the first keyword is valid.

### Creating Report Templates for PDF Report Files and Printer Output

To create a report template, use the editing tool provided by YOKOGAWA to enter keywords and text in the cells of table.

Keywords specify the type of data that will be entered into a cell. Text are output as they are in reports.

For the keywords that you can use, see “Creating Report Templates for Report Files in Excel Format.”

---

# Appendix 5 Power Recovery Operation

This section explains how the GX/GP operates when it recovers from a power failure.

## Power Failure Detection

The GX/GP power shuts down when the power is disrupted for the times indicated below.

- 100 to 240 VAC: 1 cycle or more
- 24 VDC/AC: 1 ms or more
- 12 VDC: 1 ms or more

## Basic Operation

The following operations are retained when the GX/GP recovers from a power failure.

### Recording Operation

- If a power failure occurs while the GX/GP is recording, it will continue recording when it recovers.
- Display and event data files are separated when a power failure occurs.

### Monitor Display

- The monitor display is retained.
- If a power failure occurs when a menu is showing, all unsaved settings are discarded, and the monitor display returns.
- Except for the following cases, trend waveforms continue from the end of waveforms before the power failure.
  - When the file type is set to event data only
  - When the trend interval switching function is on

### Moving Average

Moving average of AI channels are not retained. When the GX/GP recovers, a new moving average will start.

### Timer Action

- Relative timer  
Time action is retained. Relative timers do not count the power failure time.
- Absolute timer, match time timer  
If timers expire during a power failure, timeout processing occurs when the GX/GP recovers.

### Remote

Remote conditions are retained. If remote conditions change during a power failure, the corresponding remote actions are executed when the GX/GP recovers.

### Computation

- If a power failure occurs while the GX/GP is computing, it will continue computing when it recovers.
- Computation results are retained during a power failure.
- Rolling average values are also retained during a power failure.
- If absolute timers or match time timers expire during a power failure, TLOG computation is performed when the GX/GP recovers.

### Report Operation

- If a power failure occurs while the GX/GP is creating a report, it will continue to create it when it recovers.
- If timers expire during a power failure, timeout processing occurs using the data up to the power failure when the GX/GP recovers. If this occurs, the report data will contain a power failure mark.

## Communication Operation

Communication ports are closed when a power failure occurs.

- Reestablish Ethernet connections.
- Client function
  - When Modbus client is in use and a power failure occurs in the middle of a transmission, the data will not be retransmitted.
  - When the FTP client function is in use and a power failure occurs in the middle of a file transfer, the file will be re-transferred when the GX/GP recovers.
- Communication channel values are retained even during a power failure. The GX/GP can be configured so that the values take on preset values when the GX/GP recovers.

## DO Operation

DO output values are not retained during a power failure.

- Alarm output  
Alarms are set to off when the GX/GP recovers.
- Manual DO operation  
Manual DO operation is set to off, regardless of the condition before the power failure.

### Power Recovery Operation Summary

Operation	Function	Held/Not Held	Description
Recording	Recording status	Held	If a power failure occurs during recording, recording will continue when the GX /GP recovers.
	File creation	Held	A power failure divides files.
Trend waveform	File type: Event data only	Not held	Waveforms before the power failure will be lost.
	Trend rate switching	Not held	Waveforms before the power failure will be lost.
	Other than those above	Held	Continues to be displayed.
Timer	Relative timer	Held	Timers do not count during the power failure period.
	Absolute timer Match time timer	Held	If timers expire during a power failure, timeout processing occurs when the GX/GP recovers.
Remote	Remote condition	Held	If remote conditions change during a power failure, the corresponding actions are executed when the GX/GP recovers.
AI channel	Moving average	Not held	When the GX/GP recovers, a new moving average will start.
Computation	Computation condition	Held	If a power failure occurs during computing, computing will continue when the GX/GP recovers.
	Computed results	Held	Data before the power failure is retained.
	Rolling average	Held	Average values before the power failure is retained.
	TLOG Computation	Held	If absolute timers or match time timers expire during a power failure, TLOG computation is performed when the GX/GP recovers.
Communication	Connection	Not held	Connections need to be reestablished when the GX/GP recovers.
	Client	Not held	Modbus: Data in transmission is discarded. FTP: Files in transmission is retransmitted.
	Communication channel	Held	Data before the power failure is retained.
DO	Alarm	Not held	Set to off.
	Manual DO	Not held	Set to off.

---

# Appendix 6 Creating Scale Images

## Scale Images

In addition to the standard scale, you can display original scales that you create. You can display scale images at the display group level.

This feature is useful when you want to use your own scale or need a special scale for nonlinear input signals or other nonstandard signals.

## Creating a Scale Image

You can create a scale image based on a GX/GP trend screen that has been configured appropriately for your purpose. Using the GX/GP snapshot feature, save an image data (PNG format) of the trend screen to the SD memory card. Edit the image data using a software application that can handle PNG files (Windows Paint for example) to create the scale image.

### Scale Image Creation Workflow

- 1** Configuring the trend screen settings  
Set the trend screen's display direction, scale position, and the position of digital values.
- 2** Displaying the trend screen and capturing image data  
On the GX/GP, display the group trend screen that you want to show the scale image in. Using the snapshot feature, save an image data of the trend screen to the SD memory card.
- 3** Creating the scale image  
Create the scale image by editing the image data on an image editing software application.

## Scale Image Creation Procedure

### Configuring the trend screen settings

Set the following items related to the scale image according to the trend scale that you will use on the GX/GP.

- Trend display direction
  - ▶ page 1-114 in section 1.10.4, "Setting Trend Display Conditions"
- Scale position of each channel
  - ▶ AI channel: Refer to page 1-40 in section 1.2.3, "Setting the Display"
  - ▶ DI channel: Refer to page 1-60 in section 1.3.3, "Setting the Display"
  - ▶ DO channel: Refer to page 1-80 in section 1.6.2, "Setting the Display"
  - ▶ Math channel: Refer to page 1-102 in section 1.8.5, "Setting the Display"
  - ▶ Communication channel: Refer to page 1-176 in section 1.20.3, "Setting the Display"
- Number of scale digits to display
  - ▶ Refer to page 1-114 in section 1.10.4, "Setting Trend Display Conditions"
- The position of the digital values on the trend screen
  - ▶ Refer to page 2-10 in section 2.2.1, "Displaying Measured Data Using Waveforms, Numeric Values, Bar Graph, or Custom Display (/CG option) (Trend, digital, bar graph, and custom displays)"

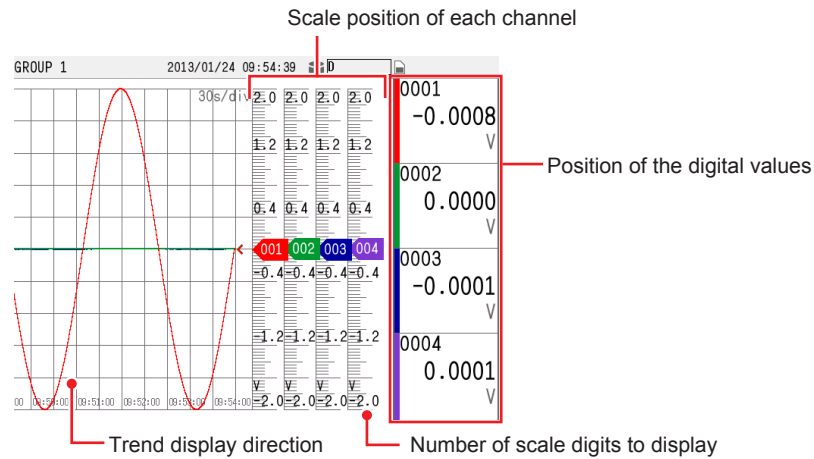

### Displaying the trend screen and capturing image data

- 1 Display the trend screen group that you want to use the scale image on.
- 2 Press **MENU**, tap **Universal** and then **Snap shot**. The image data (PNG format) of the trend screen is saved to the SD memory card.

### Creating a Scale Image

- 1 Open the image data that has been saved to the SD memory card in an image editing software application. The area outlined in red is where the scale image will be displayed. Cut this area out, and create the data for the scale image.

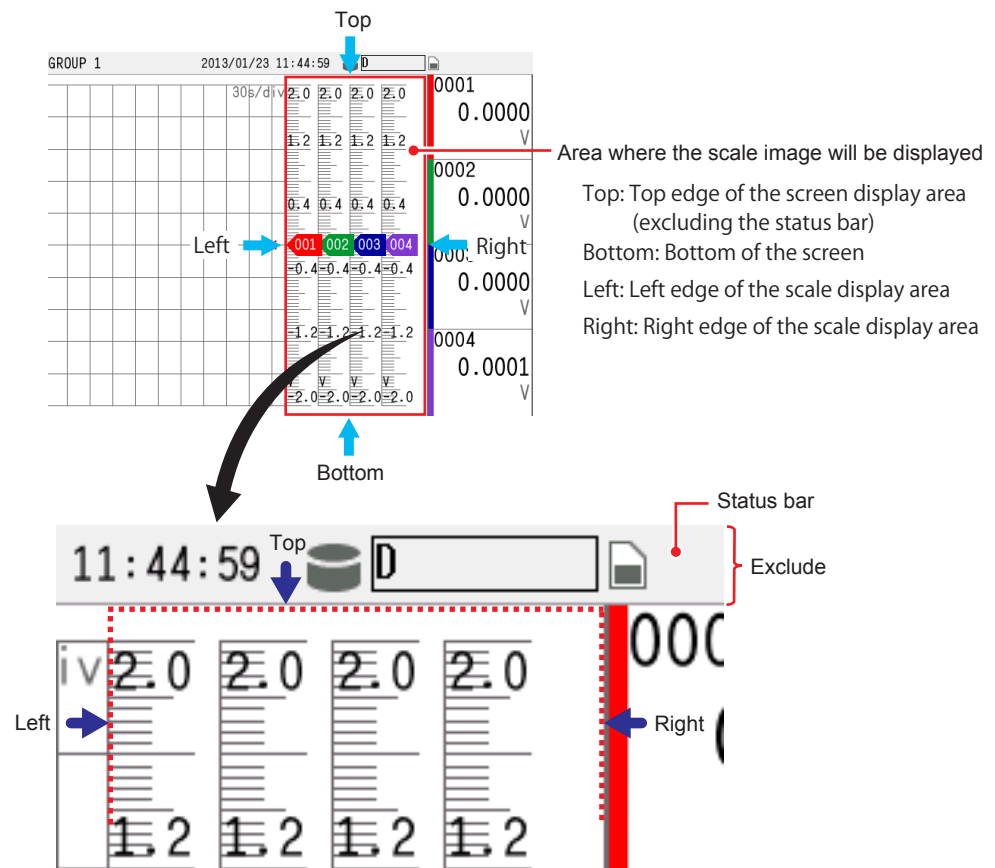

**2** Create an image only of the area that has been cut out.

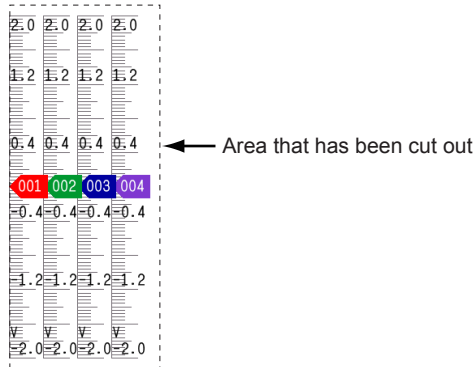

**3** To align the scale position to the positions where the value indicator marks will appear, create guidelines. The lines marked in red on the scale are the guidelines. Erase everything except for the lines marked in red. This image will be used as the base of the scale image.

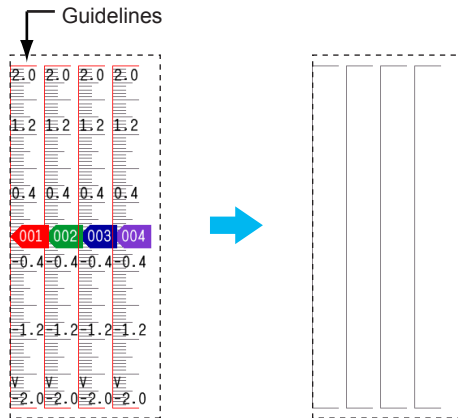

**4** On this base image, draw scales, warning areas, units, values, etc., as you like.

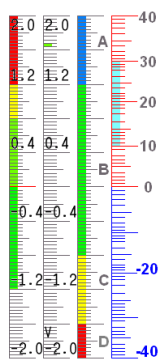

**5** After you finish creating the scale image, save it in PNG format. This completes the creation of the scale image.



# Appendix 7 Computation Examples Using Pulse Input

## Example 1: Pulse Sum Value

Sum the pulses applied to channel 0001.

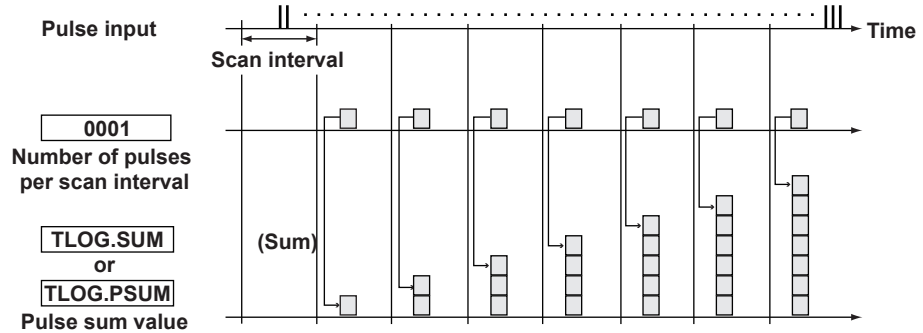

### Expression

Assign the computation channel and set the expression. Set the span lower/upper limit and unit according to the application.

Channel	Expression	Description
A001	TLOG.SUM(0001)	Sum of the number of pulses per scan interval
	TLOG.PSUM(0001)	Sum of the number of pulses per scan interval (Only the input channels of GX90XP pulse input modules)

## Example 2: Number of Pulses per Minute

With the scan interval set to 1 s,<sup>1</sup> count the pulse signal applied to 0001, and calculate and display the number of pulses per minute.

<sup>1</sup> This computation example is not possible for scan intervals faster than 1 s.

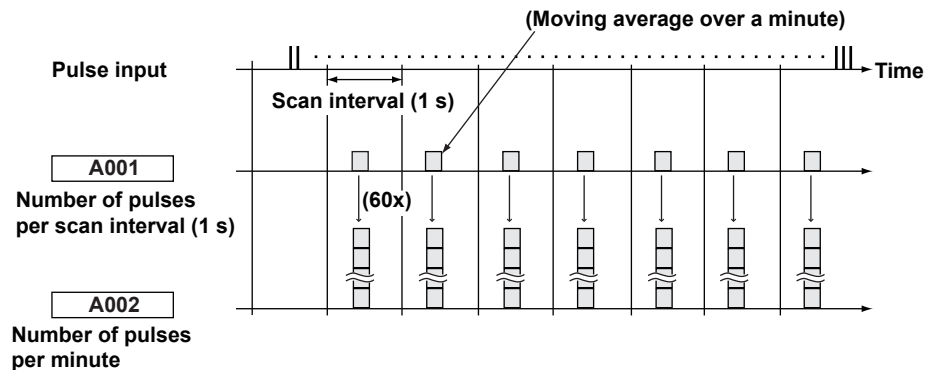

### Expression

Assign the computation channel and set the expression. Set the span lower/upper limit and unit according to the application.

Channel	Expression	Description
A001	0001	Number of pulses input to 0001
A002	A001*K001	Number of pulses per minute
Constant	Value	Description
K001	60	Coefficient for converting the number of pulses per second to the number of pulses per minute
Channel	Rolling average	Description
A001	Sampling interval: 1s Number of samples: 60	Moving average over a minute

### Channel

The computation is performed in order from the channel with the smallest channel number in one scan interval.

Use a channel of a channel number larger than that of the channel counting the number of pulses per second for the computation channel that is to calculate the number of pulses per minute.

### Example 3: Reset When the Pulse Sum Value Exceeds a Certain Value

Reset the sum value when the pulse sum value exceeds a specified value (reset value) and carry over the value exceeding the reset value to the sum after the reset. Count the number of resets and calculate the total sum value up to that point.

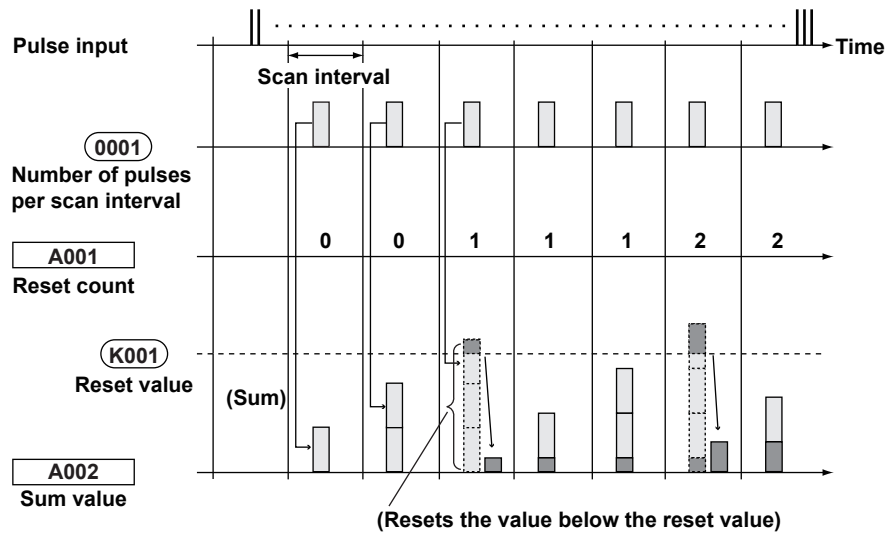

#### Expression

Assign the computation channel and set the expression. Set the span lower/upper limit and unit according to the application.

Channel	Expression	Description
A001	$((A002+0001).GE.K001)+A001$	Pulse sum value reset count
A002	$CARRY(K001):TLOG.SUM(0001)$	Pulse sum value
A003	$K001+A001+A002$	Total sum value
Constant	Description	
K001	The reset value. The sum value is reset when this value is exceeded.	

#### Channel A001: Reset Count

Calculates the number of times the pulse sum value is reset.

The expression “ $((A002+0001).GE.K001)$ ” is set to 1 when “the previous pulse sum value (A002) + the current pulse count (0001)” is greater than the reset value (K001). Otherwise, the expression is set to 0.

The value of channel A001 is incremented when the pulse sum value exceeds the reset value.

#### Channel A002: Pulse Sum Value

Calculates the pulse sum value.

Under normal conditions, the pulse sum value TLOG.SUM (0001) is calculated. When the pulse sum value is greater than or equal to the reset value (K001), the pulse sum value is set to the amount exceeding K001.

#### Channel A003: Total Sum Value

Multiplies the reset value (K001) by the reset count (A001) and adds the pulse sum value (A002) to derive the total sum value.

#### Note

- The computation is performed in order from the channel with the smallest channel number in one scan interval. If the channel number in the expression is greater than or equal to the channel number in which the expression is assigned, the previous computed result (previous value) is used for the channel in the expression.
- If the pulse input value of the scan interval is greater than the reset value, correct computation cannot be achieved.

# Appendix 8 Terminology

This section explains the terminology related to the GX/GP.

Term	Explanation	Notes
Display data	Waveform data that is displayed on the GX/GP screen. It is a recording of measured data sampled at the display data sampling interval.	
Event data	Event data is a recording of measured data at a specified recording interval. This is separate from the display data.	
Trend interval	The interval at which the waveform display is updated. The display is updated at a time interval that corresponds to 1 dot, which is determined by the specified recording interval (time interval that corresponds to 1 division).	► See page 1-110 in section 1.10.1, "Setting the Trend Interval"
I/O channel	A collective term that refers to analog input channels (AI channels), digital input channels (DI channels), and digital output channels (DO channels).	
AI channel	Analog input channel. Analog input channels can receive and measure DC voltage, thermocouple (TC), RTD, and On/Off signals (DI).	
DI channel	Digital input channel. Digital input channels can measure On/Off signals.	
AO channel	Analog output channel. These channels can output DC current signals (4-20mA, 0-20mA range).	
DO channel	Digital output channel. Digital output channels can be used as relay outputs.	
PID channel	A channel (PV, SP, OUT, AI, DI, AO, or DO) on a PID control module.	
GS (range type)	Range type for 1-5VDC and 0.4-2VDC signals	
GS (4-20mA) (range type)	Range type for 4 to 20 mADC signals (current input modules)	
DI (range type)	Range type for digital input (1, 0) based on contacts or voltage levels	
RTD (range type)	Range type for RTD sensors	
TC (range type)	Range type for thermocouple sensors	
Resistance (range type)	This is a range type for the 4-wire resistance input.	
Input calculation	Calculation performed on inputs, such as scaling, taking the difference between two channels (difference in relation to a reference channel), and square rooting.	
Historical trend	Waveform based on past measured data as opposed to the waveform based on current data. The waveform display area of historical trends shown from a memory summary, message summary, alarm summary and so on is displayed in gray.	
Color scale band	Displays a specified section (inside or outside) of the measurement range using a color band on the scale.	
Trip line	A line displayed at a specified position in the waveform display range on the trend display.	
Zone (display)	Zones enable channels to be displayed in separate areas so that waveforms do not overlap.	
Partial expanded display	Partial expanded display compresses a section of the waveform display range so that the rest of the section is expanded.	
Manual sample	An action executed through a screen operation or event action function. The action saves instantaneous values of all channels (except those set to Skip or Off).	
Snapshot	An image of the GX/GP screen saved in PNG format to an SD memory card. Some screens cannot be saved as screenshots.	
Reconfiguration	A system reconfiguration that aligns the GX/GP settings to the I/O module configuration. Reconfiguration is necessary when the positions of different types of modules are changed and when modules are added or deleted.	► See page 1-258 in section 1.29.4, "Reconfiguring the GX/GP"
Individual alarm ACK	The operation of acknowledging alarms (clearing alarm output) separately by channel and level.	► See page 1-207 in section 1.23.3, "Setting the Alarm Display Hold/Nonhold and Individual Alarm ACK Operation", page 2-69 in section 2.4.1, "Releasing Alarm Output (Alarm ACK and individual alarm ACK operation)"
General communication (GENE)	A function for communicating with the GX/GP (configuration and control) using GX/GP dedicated communication commands.	► See page 1-196 in section 1.21.9, "Setting the Server Functions to Use (FTP, HTTP, SNTP, MODBUS, GENE, DARWIN compatible communication)"

Blank

# Index

## Symbols

2ch mode.....	1-121
10ch mode.....	1-121

## A

Acknowledging all alarms.....	1-78
Acknowledging individual alarms.....	1-78, 2-70
Action on math start.....	1-159
Activating modules.....	2-65
Alarm ACK operation.....	1-78
alarm delay.....	1-66
Alarm delay.....	1-37, 1-60, 1-102
Alarm type.....	1-36, 1-38
AND/OR operation.....	1-78
Authentication.....	1-186
Authority of user.....	1-224
Auto increment.....	1-148
Automatically saving.....	2-74
Auto save.....	1-143, 1-144

## B

Bias.....	1-34
Burnout criteria.....	1-124
Burnout set.....	1-34

## C

Calibration correction.....	1-53, 1-179
Certificate for communication.....	1-261
Certificate for PDF signatur.....	1-261
Certificate signature request (CSR).....	1-261, 1-262
Change message.....	1-116
Changing each value from monitoring.....	1-118
Collectively saving unsaved data.....	2-74
Collectively storing unsaved data.....	1-146
Color scale band.....	1-46, 1-68, 1-104, 1-178
Configuration changes comment.....	1-215
Continuous channel data area.....	4-32
Continuous channel data read/write area.....	4-51
correction factor.....	1-56, 1-181
Count.....	1-31
Custom display.....	1-234, 1-244, 2-11

## D

DARWIN.....	1-197, 1-201, 1-267
Data length.....	1-128
Data types.....	1-131
Day custom.....	1-153
Decimal place.....	1-30, 1-58
Delta.....	1-29
Direction.....	1-114, 1-117
Display characters of each value.....	1-48, 1-62, 1-81
Display data.....	1-125
DO output relay operation.....	1-79

## E

Encryption.....	1-185, 1-186, 1-196, 1-260
Energize/De-energize.....	1-77
Energize or de-energize operation.....	1-78
Event data.....	1-126, 3-14
Excel report files.....	1-156
Execution of the input measurement.....	1-54

## F

FAIL relay.....	1-211
File format.....	1-147
File type.....	1-125
Free.....	1-127
Function key.....	2-72
Future Alarm.....	1-284
Future Pen Function.....	1-282

## G

Gap between messages.....	1-202
GENE.....	1-197
Gradually adjusting the time.....	1-208
grid.....	1-137, 1-138, 1-139, 1-140
GX/GP Version.....	iii

## H

hysteresis.....	1-65
Hysteresis.....	1-37, 1-59, 1-102, 1-175

## I

Individual alarm ACK.....	1-77, 1-207, 3-27
Initialize password.....	1-224
input measurement execution.....	1-54
instrument correction factor.....	1-54, 1-180
Instrument Information.....	1-211
Intermediate certificate.....	1-264

## J

Jump default display.....	1-118
---------------------------	-------

## K

Key.....	1-260
----------	-------

## L

Large memory type.....	i
Linearizer approximation.....	1-53, 1-56, 1-179, 1-181
Linearizer bias.....	1-53, 1-56, 1-179, 1-181
Linearizer input.....	1-53, 1-180
Linearizer output.....	1-53, 1-180
Linear scaling.....	1-29
Log.....	2-53
logging.....	1-66
Logging.....	1-37, 1-59, 1-102, 1-175
Low-cut output.....	1-31
Low-cut value.....	1-31

## M

Manual sample.....	1-133, 2-75
Manual sampling.....	3-13
Manual save.....	1-146, 2-74
Media FIFO.....	1-143, 1-145
moving average.....	1-64
Moving average.....	1-31

## N

Nonhold/Hold.....	1-78
Normal and remote.....	1-121

## Index

---

### O

---

Over range..... 1-52

### P

---

Partial .....1-46, 1-68, 1-104, 1-115, 1-178  
PC system requirements ..... 3-2  
PDF electronic signature ..... 1-153  
PDF report files..... 1-157  
Power-fail message .....1-116  
Pre-trigger..... 1-128

### R

---

Recommended replacement periods for worn parts..... 5-19  
Reconfiguring ..... 1-258  
Record confirmation action..... 1-128  
Recording Interval ..... 1-111, 1-126, 1-127  
Reflash ..... 1-78  
Relay action on ACK..... 1-77  
Relay deactivated interval ..... 1-78  
release number..... iii  
Repeat ..... 1-127  
Report template ..... 1-156, 1-230, 1-243  
Report template output..... 1-152  
Rolling average..... 1-87

### S

---

Saving interval ..... 1-126  
Scale lower ..... 1-58  
Scale upper ..... 1-30, 1-58  
Scan interval.....1-119  
Scroll time.....1-118, 2-20  
Second interval..... 1-111  
self-signed certificates ..... 1-261  
sensor correction factor ..... 1-54, 1-180  
Shifting the transfer time..... 3-75  
Single..... 1-127  
span lower ..... 1-64  
Span lower..... 1-29, 1-30, 1-76, 1-86, 1-173  
span upper..... 1-64  
Span upper ..... 1-29, 1-76, 1-86, 1-173  
Square root..... 1-30  
Standard type ..... i  
START/STOP key action ..... 1-83  
Status display section..... 1-50  
Status indications ..... 3-7  
style number ..... iii

### T

---

Time deviation limit ..... 1-208  
Transfer wait time ..... 1-184  
Trend clear .....1-114  
Trend interval..... 1-110, 1-111, 1-126, 1-130  
Trend rate switching .....1-110  
Trigger source operation ..... 1-128, 2-6  
Trusted certificates ..... 1-232, 1-244

### U

---

uncorrected value ..... 1-54, 1-180  
Unverified certificates ..... 1-266  
Update interval of measured values ..... 1-49  
Updating the firmware ..... 5-21

### V

---

Verification of certificate..... 1-185, 1-186  
Verifying unverified certificates ..... 2-73

### W

---

Watchdog timer ..... 1-174  
Write group.....1-116

# General Specifications

GX10/GX20  
Paperless Recorder  
(Panel mount type)

**SMARTDAC+**<sup>TM</sup>

GS 04L51B01-01EN

Release R4

## OVERVIEW

The GX10/GX20 are paperless recorders that display real-time measured data on a touch screen and save data on an external storage medium (SD card).

For the input/output module specification, please see GX90XA/GX90XD/GX90YD/GX90WD/GX90XP/GX90YA Input/Output Module and GX90UT PID Control Module General Specification (GS 04L53B01-01EN, GS 04L53B01-31EN.)

- The number of analog input is a maximum of 100 channels in GX10 with expandable I/O<sup>\*1</sup>, GM sub unit<sup>1</sup>, a maximum of 100 channels in GX20 standard type (hereafter referred to as "GX20-1") with expandable I/O, and a maximum of 450 channels<sup>\*2</sup> in GX20 large memory type (hereafter referred to as "GX20-2") with expandable I/O, GM sub unit.  
\*1 A unit for expanding the number of channels.  
\*2 Max. number of input/output channels is 500 channels.
- The GX10/GX20 have the large internal memory (GX10/GX20-1: 500MB, GX20-2: 1.2 GB), and prolonged record and preservation are possible.
- As the input signal, a DC voltage, thermocouple, resistance temperature detector, DI (DCV input (TTL), contact signal), mA (DC current), or Pulse input can be set to each channel.
- Analog output is capable of retransmission output of various types of channels and also manual output. It provides current output with channels that are isolated. (Analog output module)
- Input and output have module structure and it can extend them easily. (GX10: max. 3\*, GX20: max. 10\*)  
\* In case of using expandable I/O, GM sub unit, GX10 can extend two units, GX20 can extend 9 units.
- A module type is seven types, an analog input, an analog output, a digital input, a digital output, a digital input/output, a pulse input, and a PID control.
- Up to 6 units of expandable I/O units and GM sub units can be connected to the GX10/GX20. Each expandable I/O and GM sub unit can incorporate a maximum of six modules. With expandable I/O, GM sub unit connected, GX10 and the large memory type GX20 can use multiple channels. Furthermore, the I/O ports can be installed in separate locations from where GX10/GX20 is located, helping you reduce wiring requirements and build a decentralized configuration.
- The intuitive operation by flick, pinch in, and pinch out are possible.
- The past trend under recording can be seamlessly displayed on a trend screen.
- Predicts\* the future from past data and draws future waveforms simultaneously with real-time data on the trend screen. (Future pen function)

\* Future waveforms predicted by the Future Pen function are for reference only. Performance, accuracy, and other properties are not guaranteed.

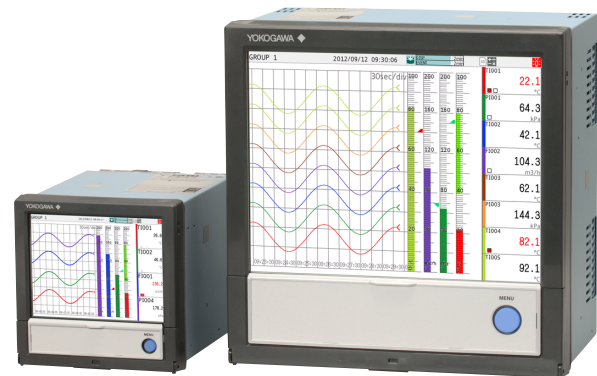

GX10

GX20

- Moreover, the measurement data of the time specified on the calendar screen can be searched and displayed.
- Various functions, such as a freehand message, a PDF/Excel output of a report file, a direct output to a network printer, a scale movement of a trend display, and a buzzer, are equipped.
- It can be hooked up to network via Ethernet, which enables to inform by Email and to monitor on Web site as well as to transfer files by using FTP. Also, it can communicate with Modbus/RTU or Modbus/TCP.
- Safe measurement up to withstand voltage of 600 V between input terminal and ground is possible by using a high withstand voltage analog input module.
- In high-speed measurement, measurement at the shortest interval of 1 ms is possible by using a high-speed analog input module (high-speed AI).
- In dual interval measurement, measurement can be performed by setting two different scan intervals.
- The PID control function enables PID control on up to 20 loops (6 loops for the GX10/GX20-1) by installing a PID control module.
- The program control function enables program control of up to 99 patterns by using a PID control module and program control function (/PG option). Up to 32 time events and 32 PV events can be set for each segment.

\* For PID control module, PID control function, and program control function (/PG), see the GX90UT PID Control Module General Specifications (GS 04L53B01-31EN)

\* The contents of this general specifications correspond to the GX10/GX20 with release number 4 and style number 2.

Release number: firmware ID number  
Style number: hardware ID number



- Various types of computation are possible with the math function (/MT option). The report function enables creation of hourly, daily, and monthly reports and other types of data. Logic math outputs results of computation as 0s or 1s to internal switches and DO channels.
- A setup of GX can be performed on-line from the web browser on PC. A setup by off-line is also possible.
- Universal Viewer software allows a PC to display waveforms on its screen and to print out waveforms.
- The measuring accuracies noted in the general specifications have a margin of error that takes into account the product's components and the equipment used for adjustment and testing. However, the actual values calculated from the accuracy testing data upon shipment of the instrument from the factory are as follows.

Input type		Measuring accuracy *1 (typical value *2)
DCV	20 mV	$\pm (0.01\% \text{ of rdg} + 5 \mu\text{V})$
	60 mV	$\pm (0.01\% \text{ of rdg} + 5 \mu\text{V})$
	6 V (1-5 V)	$\pm (0.01\% \text{ of rdg} + 2 \text{ mV})$
TC <sup>3</sup>	R, S	$\pm 1.1^\circ\text{C}$
	B	$\pm 1.5^\circ\text{C}$
	K (-200.0 to 1370.0 °C)	$\pm (0.01\% \text{ of rdg} + 0.2^\circ\text{C})$ for 0.0 to 1370.0 °C; $\pm (0.15\% \text{ of rdg} + 0.2^\circ\text{C})$ for -200.0 to 0.0 °C
	K (-200.0 to 500.0 °C)	$\pm 0.2^\circ\text{C}$ for 0.0 to 500.0 °C; $\pm (0.15\% \text{ of rdg} + 0.2^\circ\text{C})$ for -200.0 to 0.0 °C
	J	$\pm 0.2^\circ\text{C}$ for 0.0 to 1100.0 °C; $\pm (0.10\% \text{ of rdg} + 0.2^\circ\text{C})$ for -200.0 to 0.0 °C
	T	$\pm 0.2^\circ\text{C}$ for 0.0 to 400.0 °C; $\pm (0.10\% \text{ of rdg} + 0.2^\circ\text{C})$ for -200.0 to 0.0 °C
	N	$\pm (0.01\% \text{ of rdg} + 0.2^\circ\text{C})$ for 0.0 to 1300.0 °C; $\pm (0.22\% \text{ of rdg} + 0.2^\circ\text{C})$ for -200.0 to 0.0 °C
RTD	Pt100 (-200.0 to 850.0 °C)	$\pm (0.02\% \text{ of rdg} + 0.2^\circ\text{C})$
	Pt100 (high resolution) (-150.00 to 150.00 °C)	$\pm (0.02\% \text{ of rdg} + 0.16^\circ\text{C})$

\*1 Applies to GX90XA-10-U2, A/D integration time 16.67ms or more, General operating conditions: 23 $\pm$ 2 °C, 55 $\pm$ 10% RH, supply voltage 90–132, 180–264 VAC, supply frequency within 50/60 Hz  $\pm$ 1%, warm-up of 30 minutes or more, no vibrations or other hindrances to performance.

\*2 For the measuring accuracy (guaranteed), see the module's general specifications (GS04L53B01-01EN).

\*3 These values do not include the reference junction compensation accuracy.  
rdg: reading value.

## ■ MAIN UNIT SPECIFICATIONS

### ■ FUNCTIONAL SPECIFICATION

#### Input/Output Specifications

Please see GX90XA/GX90XD/GX90YD/GX90WD/GX90XP/GX90YA I/O Module and GX90UT PID Control Module General Specifications.

Model	Name	General Specification No.
GX90XA	Analog input module	GS 04L53B01-01EN
GX90DX	Digital input module	
GX90YD	Digital output module	
GX90WD	Digital input/output module	
GX90XP	Pulse input module	
GX90YA	Analog output module	GS 04L53B01-31EN
GX90UT	PID control module	

#### Measuring Functions

- The number of installable modules and I/O channels (total for GX, expandable I/O and GM sub unit)

##### GX10/GX20-1

Item	GX10/GX20-1
Number of module	Max. 10
Number of input/output module	Max. 100

##### GX20-2

Item	GX20-2
Number of module	Max. 45
Number of input/output module	Max. 500 (or max. 450 for AI only)

Module installation limitations:

See "Limitations" and "Notes on Module Installation."

- Expandable I/O, GM sub unit connection\*  
Number of connectable units: Up to 6 units total  
\* Connection is not possible if the measurement mode is set to High speed.  
For details on expandable I/O units and GM sub units, see the respective General Specifications (GS 04L53B00-01EN, GS 04L55B01-01EN).



**Scan interval:**

1, 2, 5, 10, 20, 50, 100, 200, 500 ms, 1, 2, 5 s  
 Note) Some intervals will be unavailable depending on the system configuration and modules.  
 For details, see the I/O Module General Specifications (GS 04L53B01-01EN) and "Limitations" in this manual.

**Measurement mode:**

- Normal  
 A mode in which the shortest measurement interval is 100 ms  
 Number of measurement groups: 1  
 File type: Display data, event data  
 Data format: Binary or text  
 Scan interval: 100 ms (fastest)  
 Compatible modules: All modules
- High speed  
 A mode in which high-speed measurement is possible at the shortest measurement interval of 1 ms  
 Number of measurement groups: 1  
 File type: Event data only  
 Data format: Binary only  
 Scan interval: 1 ms (fastest)  
 Compatible modules: High-speed AI (GX90XA-04-H0), DI (GX90XD), DIO (GX90WD)  
 However, one module, either DI or DIO, can be installed. DI input is fixed to remote mode. Measurement and recording are not possible.
- Dual interval  
 A mode in which measurement is possible by setting different scan intervals on the two measurement groups.  
 Number of measurement groups: 2  
 File type: Event data only  
 Data format: Binary only  
 Scan interval:

Model	measurement group 1	measurement group 2
GX10/GX20-1	5 ms (fastest)	100 ms (fastest)
GX20-2	1 ms (fastest)	100 ms (fastest)

Compatible modules: All modules except PID control module

- \* Depending on the measurement mode, there is a limit to the number of measurement channels and recording channels at scan intervals shorter than 100 ms. See "Limitations."

**Display Functions****Display groups:**

Number of groups; GX10: 30, GX20-1: 50, GX20-2: 60  
 Number of channels that can be assigned to each group; GX10: 10, GX20: 20

**Display color (Trend/Bar graph/Digital display):**

Channel: Select from 24 colors  
 A desired display color can be selected freely using its RGB value.  
 Background: Select from white or black

**Display type:**

- Trend display (T-Y)  
 Display method:  
 Direction: Horizontal, vertical  
 Trend interval (Recording interval): 50 ms/div (1 ms), 100 ms/div (2 ms), 250 ms/div (5 ms), 500 ms/div (10 ms), 1 s/div (20 ms), 2.5 s/div (50 ms), 5 s/div (100 ms), 10 s/div (200 ms), 15 s/div (500 ms), 30 s/div (1 s), 1 min/div (2 s), 2 min/div (4 s), 5 min/div (10 s), 10 min/div (20 s), 15 min/div (30 s), 20 min/div (40 s), 30 min/div (1 min), 1 h/div (2 min), 2 h/div (4 min), 4 h/div (8 min), 10 h/div (20 min)
  - Trend interval shorter than 30 s/div (1 s) cannot be set on electromagnetic relay type analog input modules.
  - Trend interval shorter than 15 s/div (500 ms) cannot be set on low withstand voltage relay type analog input modules.
  - Scan interval shorter than 5 s/div (100 ms) can be specified when the measurement mode is set to High speed or Dual interval.
  - On the GX10/GX20-1, scan interval shorter than 250 ms/div cannot be specified in dual interval mode.
- Trend line width: Thick, normal, thin  
 Scale; GX10: Max. 6, GX20: Max. 10  
 Current value bar graph, color scale band, and alarm point marks can be displayed on the scale.  
 A bitmap image scale can be attached.  
 Moving scale; Scale can be moved on any waveform.
- Others; Grid (Auto, 4 to 12), Trip line, Message, Zone display, Partial expanded display
- Historical trend display (T-Y display)  
 Redisplays the display data or event data in the internal memory or external storage medium  
 Time axis operation: The time axis can be reduced or expanded.  
 Data search: Waveforms from the internal memory can be displayed through the specification of a date and time, calendar, each summary  
 All historical trends can be displayed in one screen.
- Bar graph display  
 Direction: Vertical or horizontal  
 Scale: Display a scale for each channel  
 Color scale band, and alarm point marks can be displayed on the scale.
- Digital display  
 Displays measured values numerically  
 A DI input state can be displayed as an arbitrary character string (0=Off/1=On, etc.)  
 Update rate: 0.5 s

- **Overview display**  
Display format: All channels, each groups  
Displays the measured values of all channels and the alarm statuses  
Display in groups only when the maximum number of channels that can be displayed (30 on the GX10, 100 on the GX20) is exceeded.
- **Alarm summary display**  
Displays a log of up to 1000 alarms  
Specify an alarm with the cursor and jump to the corresponding section on the historical trend display.
- **Future alarm summary display**  
Displays a list of alarms currently detected by the future alarm function (the history of future alarms is not stored)
- **Message summary display**  
Time and content of up to 500 messages (simultaneous writing: 450, additional writing: 50)  
Specify a message with the cursor and jump to the corresponding section on the historical trend display.
- **Memory summary display**  
Displays the information (up to 500 (GX10/GX20-1) or up to 1000 (GX20-2) of the data in the memory  
Specify a file with the cursor and jump to the corresponding section on the historical trend display.
- **Report display**  
Displays the report data residing in the internal memory  
For more details, see "MATHEMATICAL FUNCTIONS WITH REPORT FUNCTION (/MT)."
- **Log display**  
Displays the event log, error log, communication log, FTP log, Web log, e-mail log, SNTP log, DHCP log, Modbus log and SLMP log.
- **Multi-panel display (Only for GX20)**  
Divides the screen into two to six sections and displays some different display formats.
- **Internal switch/relay state display**  
Displays the internal switch and ON/OFF state of DO  
Operates the internal switch and ON/OFF state
- **Control screen display (when a PID control module is installed)**  
Control group, control overview, tuning, control summary, control alarm summary, program operation,\* program selection\*  
\* Only when the /PG option is installed
- **Other displays**  
Network information display  
System information display  
System configuration display

#### Auto scroll ON/OFF:

The displayed groups can be automatically switched at a specified interval.  
The display switches in ascending group order.

#### Names of channels:

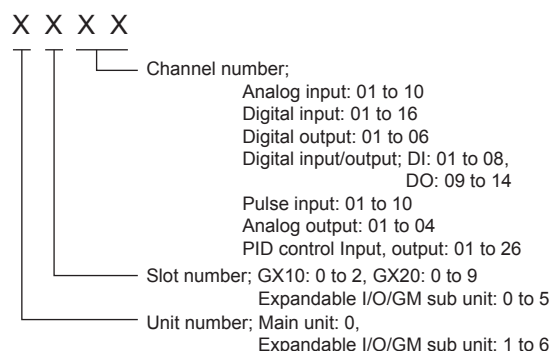

#### Tags:

- Tag and Tag numbers can be displayed.
- Tag number; Number of characters: Up to 16  
Displayable characters: Alphanumeric characters  
Tag numbers can be enabled or disabled.
- Tag; Number of characters: Up to 32  
Displayable characters: Alphanumeric characters

#### Message:

- Write messages to the trend display.
- Number of messages: 100
- Number of characters: Up to 32
- Write method: Write a preset message or write an arbitrary message on the spot.
- Write destination: Select only the displayed group or all groups.
- Auto message: Write a message when the GX recovers from a power failure while memory sampling is in progress.  
Write a message when the trend interval is switched during memory sampling.

#### Add message:

- Write messages to the past data positions.
- Message: The same as the "Message" item above  
Number of writable messages per file: 50 messages (including 10 freehand messages)

#### Freehand message:

- Can be written by dedicated pen.  
Number of writable messages per file: 50 messages (including 10 Add messages)

#### Data Saving Functions

##### Internal memory:

- Temporarily saves various types of data.
- Medium: Flash memory
- File storage capacity;  
GX10, GX20-1: 500 MB  
GX20-2: 1.2 GB

##### External storage medium:

- Medium SD card (SD/SDHC) (up to 32 GB)
- Format: FAT32 or FAT16

##### Data type:

- Display data, Event data, Alarm summary data, Manual sampled data, Screen image data, Setup data, and Report data

**Display data:**

- Target: Measurement (input/output module)/ math/communication channels, alarm summary, message summary  
Description: Maximum or minimum value per recording interval
- Recording intervals: Determined by the trend interval, recording data type (display data/display data + event data, GX20-2)
- Number of channels that can be recorded  
For GX20-1

Trend interval (div)	Number of channels
5 s	100
10 s	200
15 s or longer	500

For GX20-2

Trend interval (div)	Number of channels	
	Display data	Display data + Event data
5 s	200	100
10 s	500	200
15 s	1000	500
30 s or longer	1000	1000

Note that the maximum number of channels is fixed at 100 in the GX10.

- Data size;  
Analog input data: 12 bytes/ch.  
Analog output data: 12 bytes/ch.  
Digital I/O data: 4 bytes/ch.  
Pulse input data: 12 bytes/ch.  
Math channel data: 12 bytes/ch.  
Communication channel data: 12 bytes/ch.
- File size: Up to 18 MB
- Number of files for GX10, GX20-1: Up to 500 (including event data), for GX20-2; Up to 1000 (including event data)  
Operation in the internal memory: FIFO (First In First Out)
- Data format: Binary or text
- Recording: Records data at all times.
- Display data file sample time  
Measurement channel = 30. Math Channel = 0

Internal Memory	500 MB
Trend interval (minute/div)	30 minutes
Recording interval (s)	60 s
Total sample time	Approx. 2.5 years

**Event data:**

- Target: Measurement (input/output module)/ math/communication channels, alarm summary, message summary, operation log  
Description: Instantaneous value per recording interval
- Recording intervals: Determined by the scan interval, recording data type (display data/display data + event data)
- Number of channels that can be recorded:  
Measurement mode: Normal

For GX20-1

Recording interval	Number of channels <sup>*1</sup>
100 ms	100
200 ms	200
500 ms or longer	500

For GX20-2

Recording interval	Number of channels <sup>*1</sup>	
	Display data	Display data + Event data
100 ms	500	100
200 ms	500	200
500 ms	1000	500
1 s or longer	1000	1000

Note that the maximum number of channels is 100 in the GX10.

Measurement mode: High speed

Recording interval	Number of channels <sup>*1</sup>		
	GX10	GX20-1	GX20-2
1 ms	2	2	10
2 ms	4	4	20
5 ms	10	10	50
10 ms	20	20	100
20 ms	40	40	150
50 ms	100	100	150
100 ms	100	100	200
200 ms	100	200	500
500 ms	100	500	1000
1 s or longer	100	500	1000

Measurement mode: Dual interval

Recording interval	Number of channels <sup>*1*2</sup>		
	GX10	GX20-1	GX20-2
1 ms	—	—	5
2 ms	—	—	10
5 ms	5	5	25
10 ms	10	10	40
20 ms	20	20	50
50 ms	50	50	50
100 ms	100	100	100
200 ms	100	100	200
500 ms	100	250	600
1 s or longer	100	250	600

\*1 Total number including I/O channels, math channels, and communication channels

\*2 Number of channels that can be recorded is the same for scan group 1 and scan group 2.

- Data size;  
Analog input data: 6 bytes/ch.  
Analog output data: 6 bytes/ch.  
Digital I/O data: 2 bytes/ch.  
Pulse input data: 6 bytes/ch.  
Math channel data: 6 bytes/ch.  
Communication channel data: 6 bytes/ch.
- File size: Up to 18 MB
- Number of files for GX10, GX20-1: Up to 500 (including display data), for GX20-2; Up to 1000 (including display data)
- Operation in the internal memory: FIFO (First In First Out)
- Data format: Binary or text
- Mode; Free: Records data at all times.  
Trigger: Starts recording data when a certain event occurs and records for the specified interval.  
Repetition trigger: Repeat Trigger mode
- Event data file sample time  
Measurement channel = 30. Math Channel = 0

Internal Memory	500 MB
Recording interval (s)	1 s
Total sample time	Approx. 1 month

#### Manual Sampled Data:

- Item: Instantaneous value at an arbitrary time
- Target: Measurement (input/output module)/ math/communication channels
- Number of recording channels;  
GX10, GX20-1: Max. 50  
GX20-2: Max. 100
- Maximum number of data values that the internal memory can store: 400
- Data format: Text

#### Report Data:

- Item: Report at each scheduled time of report
- Target: Measurement (input/output module)/ math/communication channels
- Maximum number of reports that the internal memory can store: 800
- Data format: Text

#### Snapshot Data:

- Item: Displayed screen image data
- Data format: PNG
- Output destination: External medium or communication output

#### Setup Data:

- Item: GX setup data
- Data format: Text
- Output/read destination (for saving/loading): External medium

### Alarm Functions

- Number of alarms: Up to four alarms (level) for each measurement channels
- Alarm type: High limit, low limit, difference high limit, difference low limit, high limit on rate-of-change alarm, low limit on rate-of-change alarm, delay high limit, and delay low limit
- Alarm delay time: 1 s to 24 hours (for each channel)
- Rate-of-change calculation interval of rate-of-change alarms: 1 to 32 times the scan interval (common to all channels)
- Hysteresis: 0.0 to 5.0% of the span (for each

- alarm (level))
- Alarm output: Output to the internal switch, relay  
Internal switch/relay operation: AND/OR operation selectable
- Display: Displays the status on the respective operation screen and an alarm icon on the status display section when an alarm occurs.  
Display operation: Hold or not hold the display until the alarm acknowledge operation
- Alarm hide function (alarm no logging function)  
Used for relay and internal switch output and events of event action and not recorded in alarm display or alarm summary (each channel)
- Alarm information: Displays a log of alarm occurrences on the alarm summary
- Reflash: The duration for which the reflash relays are deactivated can be set to 500 ms, 1 s, or 2 s.
- Individual alarm ACK function:  
Alarm display and relay output can be cancelled on individual alarms

### Event Action Functions

- Event action: Execute a specified operation when a given event occurs.
- Number of settings: 50  
Events: Remote control input, etc.  
Number of timers: 12  
Number of match time timers: 12  
Action: Specify memory start/stop, alarm ACK, etc.

### Control Event Action Functions

See GX90UT PID Control Module General Specifications (GS 04L53B01-31EN).

### Future Pen Function

This is available when the measurement mode is normal and when the advanced security function (/AS option) and multi-batch function (/BT option) are disabled.

#### Future pen:

For channels registered as targets of the future pen, the waveform of the future part can be drawn on the trend screen.

- Maximum number of channels: 10
- Prediction range: Recording interval x 60 point
- Recording interval: Enabled when 1 s or more  
Suitable for data with relatively moderate fluctuations.

Not suitable for data that fluctuates rapidly.

#### Future alarm:

For channels registered as targets of the future pen, an alarm can be generated for measured values predicted in the future.

The alarm value of the future alarm uses the existing alarm setting value.

- Target alarm types: High limit, Low limit, Difference high limit\*, Difference low limit\*  
\* For channels for which delta is set, only the difference high limit and difference low limit are enabled.
- Display: When a future alarm occurs, the status appears<sup>1</sup> on each operation screen and the alarm icon\* appears in the status display area.  
\* However, normal alarm display has priority.
- Future alarm mail: Alarm emails can be sent when a future alarm occurs/is released.

- Event Action: Set actions can be run when a future alarm occurs/is released.

Note)

- 1 Multi panel screen and custom display cannot display predicted future waveforms.
- 2 Disabled when trend rate switching is ON.
- 3 Disabled when the file type is event and the recording mode is single/repeat.
- 4 If the input type is Log input, Pseudo-log input, or Linear-log input, predicted future waveforms cannot be displayed.
- 5 The web application cannot display predicted future waveforms and future alarms.

## Security Functions

- Operation lock function: Limitations to touch operation, access to the external storage medium, and various operations
- Login function: Only registered users can operate the GX.  
It can be set to each of touch operation and communication access.  
System administrators and Users: 50 (totally)  
Number of Authority of user: 10 level

## Clock Functions

- Clock: With a calendar function
- Accuracy:  $\pm 5$  ppm (0 to 50°C), excluding a delay (of 1 second, maximum) caused each time the power is turned on.
- Time difference between units:  $\pm 2$ ms max. (time difference between a GX and I/O Base Unit (Expandable I/O))
- Time setting: Using touch operation, communication command, event action function, or SNTP client function
- Time adjustment method:  
Limit in which the time is gradually adjusted: Select from the available settings between 5 s and 15 s.  
Whether to change an out-of-limit operation immediately or report it as an error can be selected.  
While memory sampling: Corrects the time by 1 ms for each second.  
While memory is stopped: Immediately change the time.
- DST: The date/time for switching between standard time and DST can be specified.
- Time zone: Sets the time difference from GMT.
- Date format: Select "YYYY/MM/DD", "MM/DD/YYYY", "DD/MM/YYYY" or "DD.MM.YYYY".  
MM expression can be selected from the numeric character or ellipsis. Ex. January: 01 or Jan  
The delimiter can be selected from "/", ".", "-".

## Ethernet Communication Functions

- Electrical specifications: Conforms to IEEE 802.3
- Connection: Ethernet (10BASE-T/100BASE-TX)
- Max. segment length: 100 m
- Max. connecting configuration: Cascade Max. 4 level (10BASE-T), Max. 2 level (100BASE-TX)
- Connector: RJ-45
- Protocols: TCP, UDP, IP, ICMP, ARP, DHCP, HTTP, FTP, SMTP, SNTP, Modbus, and dedicated protocols
- E-mail client: Automatically send e-mail at specified times.  
E-mail is sent by events as below.
  - Alarm occurring/alarm releasing (Max. 50ch)
  - Recover from power failure
  - Report data generating
  - Storage medium error, FTP client function error
  - Specified time period
  - Future alarm occurring/alarm releasing
- POP before SMTP and SMTP authentication (PLAIN and CRAM-MD5) is available.
- FTP client: Automatically transfer data files to the FTP server.  
Applicable files: Display data, event data, screen image data, report data, etc.
- FTP Server: Transfer files, delete files, manipulate directories, and output file lists of the GX.  
Number of the simultaneous connection: Max. 4
- Web server: Web application, GX real-time monitoring and setting changes/operations can be performed with the Web browser.  
The screen layout can be determined independently of the screen of the GX main unit.  
Number of the simultaneous connection: Max. 4
- SNTP client: Inquires the time to the SNTP server and sets the GX.
- SNTP server: Outputs the GX time.  
Time resolution: 5 ms
- DHCP client: Automatically obtain the network address settings from the DHCP server.
- Modbus client\*: Reads data from another device and writes to the registers.  
Number of connectable sever;
  - GX10, GX20-1: Max. 16
  - GX20-2: Max. 32
 \*: Required /MC option
- Modbus server: Loads measurement and math channel data  
Loads and writes communication channel data  
Some control commands such as memory start  
Modbus client\* register access limitations  
\*: Required /MC option  
Number of the simultaneous connection: Max. 4
- Setting/Measurement server: Operate, set, and output data of the GX using a dedicated protocol.  
Number of the simultaneous connection: Max. 4



- DARWIN compatible communication server: Supports some DARWIN commands  
Communication with GX is possible using DARWIN communication commands.
  - Output-related commands: Output measurement (IO) channel data, Output calculation channel data, Output relay status, Output the position of the decimal point for the measurement (IO) channel, Output the position of the decimal point for the calculation channel, Output the information on system configuration
  - Setup-related commands: Range, Scale unit, Alarm, Time, Moving average, zone
  - Operation-related commands: Reset alarm, Reset timer, Start MATH calculation, Rebuild system, Initialize, Input communication, Output communication DO, Write message

### Batch Function

- Function: Data management using batch names. Enter text fields and batch comments in the data file.
- Batch name: Added to the file name of the display data and event data.  
Structure: Batch number (up to 32 characters) + lot number (up to 8 digits)  
Use/not use selectable for lot number, on/off selectable for auto increment function.
- Text field: Adds text to the display data and event data.  
There are 24 available text fields.  
Up to 20 title characters and 30 other characters can be entered per field.
- Batch comment: Adds text to the display data and event data.  
3 comments (max. 50 characters) are available.

### Printer Output Function

- Snapshot Data can be printed out with any LAN-connected printer supporting the HP PCL5c language and the port 9100.

### SSL Communication Functions

Communication that sends and receives information encrypted by the SSL (Secure Socket Layer) protocol is possible.

- Server function:  
Supported servers: HTTP server and FTP server (Port number: 443 when encryption is used)  
Private key: Created in GX and saved in the internal memory  
Server certificate: Server certificates created by users can be saved in the internal memory. Self-signed certificates can be created in GX.
- Client function:  
Supported clients: FTP client (only Explicit mode is supported) and SMTP client (only STARTTLS is supported)  
Trusted certificate: Trusted certificates (a total of up to 80 KB) can be saved in the internal memory.

### Electronic Signature Function

Electronic signatures can be added to report files created in PDF format using the PDF form creation function. An electronic signature is provided each time a report file is created.

- Certificate for electronic signature: Certificates for electronic signatures created by users can be saved in the internal memory.

### Loop Control Function (with PID control module)

See GX90UT PID Control Module General Specifications (GS 04L53B01-31EN).

### Other Functions

- Buzzer: GX makes a buzzer sound at touch screen operation, or when alarm occurs.
- Backlight saver function: Dim or turn off the LCD backlight if there is no key operation for a specified time.
- Favorite display: Register frequently used displays to the Favorite and show them through simple operation.
- The main alarm is indicated using the MENU key LED.  
No alarm: Blue (same condition as power-on)  
Alarm condition: Red.
- User function feature: A button (user function key) to which the user can assign a desired function is provided. It can be assigned to an event triggered by the event action function.
- Firmware update function: The Web application, the IO module, or the expansion module firmware can be updated by operating GX.

## ■ HARDWARE SPECIFICATIONS (MAIN UNIT)

### Display

#### Display unit\*:

GX10: 5.7-inch TFT color LCD (640 × 480 dots)  
GX20: 12.1-inch TFT color LCD (800 × 600 dots)

\* A small number of missing or steady-on LCD pixels and minor variations in brightness uniformity is a normal display characteristic and not a malfunction.

#### Touch screen:

4 wire resistive touch screen

### Construction

- Mounting: Flush panel mounting (on a vertical plane)
- Mounting angle: Inclined backward up to 30 degrees from a horizontal plane. Left and right horizontal
- Panel thickness: 2 to 26 mm
- Material;  
Case: Metal plate  
Bezel and display cover: Polycarbonate
- Color;  
Case: Smoke blue (Munsell 4.1PB6.0/4.5 equivalent)  
Bezel: Charcoal grey light (Munsell 10B3.6/0.3 equivalent), front door: Light grey (Munsell 5.2PB8.2/1.0 equivalent)
- Front panel: Water and dust proof: Complies with IEC529-IP65 and NEMA No.250 TYPE 4 (except External Icing Test), except for side-by-side mounting
- External dimensions:  
When installing modules  
GX10: 144(W) × 144(H) × 255(D) mm  
GX20: 288(W) × 288(H) × 220(D) mm  
When uninstalling modules  
GX10: 144(W) × 144(H) × 174(D) mm  
GX20: 288(W) × 288(H) × 169(D) mm  
(D: depth from the panel mounting plane)
- Weight:  
GX10: Approx. 2.1 kg, GX20: Approx. 6.0 kg (excluding modules)

### Power Supply

- Rated supply voltage: 100 to 240 VAC
- Allowable power supply voltage range: 90 to 132, 180 to 264 VAC
- Rated power supply frequency: 50/60 Hz
- Inrush current rating 60 A or more (other than / P1)
- Power consumption:

Supply voltage	LCD backlight off	Normal operation	Maximum
100 V AC	GX10: 16 VA GX20: 28 VA	GX10: 20 VA GX20: 34 VA	GX10: 48 VA GX20: 90 VA
240 V AC	GX10: 24 VA GX20: 38 VA	GX10: 30 VA GX20: 45 VA	GX10: 60 VA GX20: 110 VA

\* The following combinations are assumed for LCD backlight off and normal operation.

GX10: 1 AI module, 1 DO module, 1 DI module  
GX20: 5 AI modules, 4 DO modules, 1 DI module

- Module power supply voltage: The total allowable power consumption of respective modules is up to 6 W in the GX10 and up to 20 W in the GX20.
- Allowable interruption time: Less than 1 cycle of the power supply frequency

### Isolation

- Insulation resistance: Between the Ethernet, RS-422/485, and each insulation terminals and earth: 20 MΩ or greater at 500 VDC
- Withstand voltage:  
Between the power terminal and earth: 3000 V AC at 50/60 Hz for one minute  
Between the contact output terminal and earth: 3000 V AC at 50/60 Hz for one minute  
Between the input/output modules and earth: Depends on the specification of I/O module.
- Grounding: Be sure to set a low grounding resistance.
- Isolation:

Power terminal	FAIL output terminal	Internal circuit
	Ethernet port	
	RS-422/485 terminal	
	Input and output module terminal	
	Input and output module internal circuit	
	Earth (PE) terminal	
	RS-232 terminal	
	SD card slot	
	USB port	

The circuits divided by lines are insulated mutually.

### Safety and EMC Standards

- CSA:  
CAN/CSA22.2 No.61010-1, overvoltage category II or I<sup>\*1</sup>, pollution degree 2<sup>\*2</sup>  
CAN/CSA-C22.2 NO. 61010-2-030  
CAN/CSA-IEC 61010-201<sup>\*4</sup>
- UL:  
UL61010-1, UL 61010-2-030 (CSA NRTL/C)  
UL61010-2-201 (CSA NRTL/C)
- CE/EMC directive:  
EN61326-1 compliance, Class A Table 2  
EN61000-3-2 compliance  
EN61000-3-3 compliance  
EN55011 Class A Group 1
- CE/Low voltage directive:  
EN61010-1, EN 61010-2-030  
Overvoltage category II or I<sup>\*1</sup>  
Pollution degree 2<sup>\*2</sup>  
Measurement category<sup>\*3</sup>  
EN61010-2-201<sup>\*4</sup>
- EMC Regulatory Arrangement in Australia and New Zealand (RCM): EN55011 compliance, Class A Group 1
- KC marking: Electromagnetic wave interference prevention standard, electromagnetic wave protection standard compliance

\*1 Overvoltage category:

Describes a number which defines a transient overvoltage condition.

Implies the regulation for impulse withstand voltage. "II" applies to electrical equipment which is supplied from the fixed installation like a distribution board.

II: Applied to standard power supply (100-240 VAC)

I: Applied to /P1 option (21.6-26.4 V AC/DC)

- \*2 Pollution degree 2:  
Describes the degree to which a solid, liquid, or gas which deteriorates dielectric strength or surface resistivity is adhering.  
"2" applies to normal indoor atmosphere.  
Normally, only non-conductive pollution occurs.
- \*3 Measurement category: Depends on the specification of each modules
- \*4 Support for GX10/GX20 hardware style 2 and later.  
This product is designed as open equipment under the relevant standard, install it as follows:  
• The GX10/GX20 is designed to be installed in an instrumentation panel.  
Install it in a location where people cannot touch the terminals carelessly.  
• Install the GX60/GM unit in a panel with a door.  
• The instrumentation panel or panel used for support must comply with CSA/UL/EN 61010-2-201 or must be at least IP1X (degrees of protection) and at least IK09.

### Other Specifications

- Memory backup: A built-in lithium battery backs up the settings and runs the clock
- Recommended replacement periods of Battery: Approximately 10 years (at room temperature)

### Transport and Storage Conditions

- Ambient temperature: -25 to 60°C
- Ambient humidity: 5 to 95 %RH (no condensation)
- Vibration: 10 to 60 Hz, 4.9 m/s<sup>2</sup> maximum
- Shock: 392 m/s<sup>2</sup> maximum (in packaged condition)

Category	Measurement category	Description	Remarks
II	CAT II	Available in the testing and measuring circuits directly connected to a usage location (receptacle or the like) of a low-voltage main power supply facility.	Appliances, portable equipment, etc.
III	CAT III	Available in the testing and measuring circuits connected to a power distribution portion of a low-voltage main power supply facility.	Distribution board, circuit breaker, etc.
IV	CAT IV	Available in the testing and measuring circuits connected to a power source of a low-voltage main power supply facility.	verhead wire, cable systems, etc.

- WEEE Directive: Compliant

### Normal Operating Conditions

- Power supply voltage: 100 to 240 V AC  $\pm 10\%$
- Power supply frequency: 50/60 Hz  $\pm 2\%$
- Ambient temperature: 0 to 50 °C
- Ambient humidity: 20 to 80 %RH (at 5 to 40°C) (no condensation)
- Magnetic field: 400 A/m or less (DC and 50/60 Hz)
- Vibration:  
5  $\leq$  f < 8.4 Hz amplitude 3.5 mm (peak)  
8.4  $\leq$  f  $\leq$  160 Hz acceleration 9.8 m/s<sup>2</sup>
- Shock:  
Non-energization, 500 m/s<sup>2</sup> or less, approximate 10 ms, 6 directions ( $\pm X$ ,  $\pm Y$ ,  $\pm Z$ ), 3 times in each direction
- Mounting position: Can be inclined up to 30 degrees backward. Left and right horizontal when installing the panel mount and wall mount.
- Altitude: 2000 m or less
- Installation location: Indoors
- Warm-up time: At least 30 minutes after power on



## EXTERNAL DIMENSIONS AND PANEL CUTOUT DIMENSIONS

### GX10:

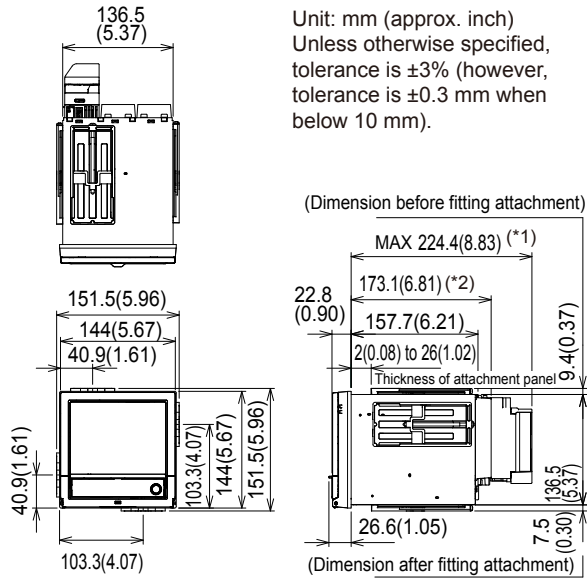

Panel cut dimensions

Single-Unit Mounting

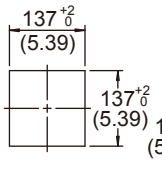

Side-by-Side Mounting (horizontally)

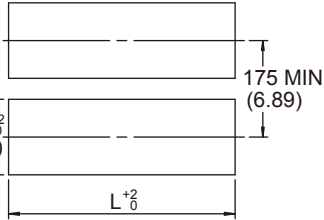

Side-by-Side Mounting (vertically, max. 3 units)

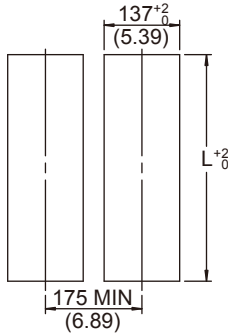

Units	$L^{+2}_0$
2	282 (11.10)
3	426 (16.77)
4	570 (22.44)
5	714 (28.11)
6	858 (33.78)
7	1002 (39.45)
8	1146 (45.12)
9	1290 (50.79)
10	1434 (56.46)
n	(144x n)-6

Rear view

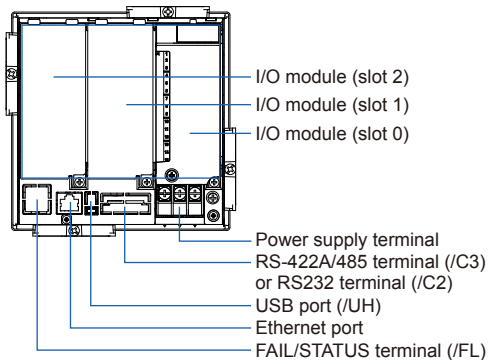

### GX20:

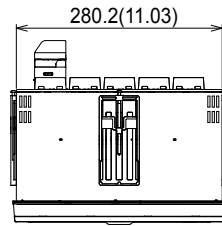

Unit: mm (approx. inch)  
Unless otherwise specified, tolerance is ±3% (however, tolerance is ±0.3 mm when below 10 mm).

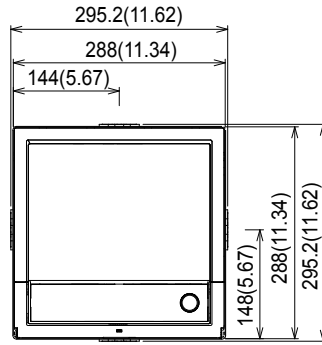

(Dimension before fitting attachment)

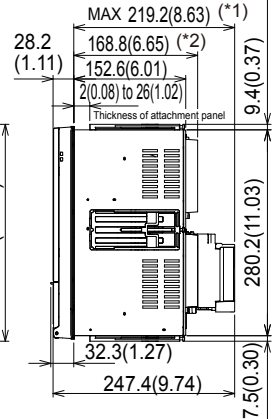

\*1: with modules  
\*2: without modules

Panel cut dimensions

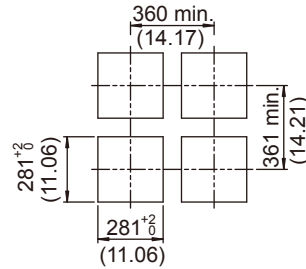

Rear view

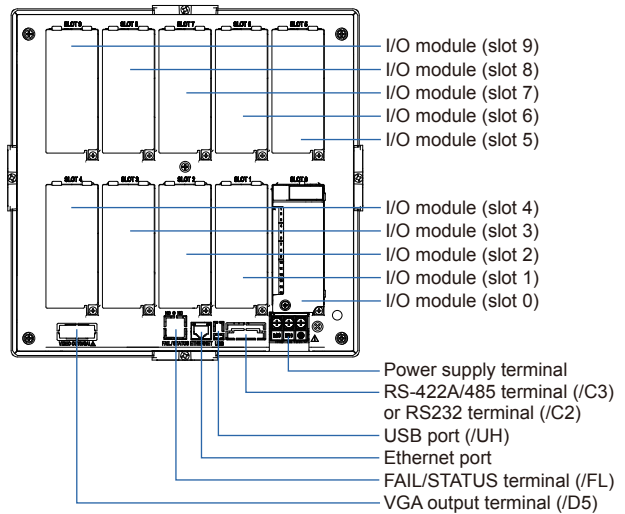

### Precautions to Be Taken While Wiring

With a screw terminal, we recommend that you use a crimp-on lug with an insulation sleeve (M4 for power supply wiring, M3 for signal wiring).  
Recommended signal wiring crimp-on lug N1.25-MS3 (JST Mfg. Co., Ltd.)

## ■ SPECIFICATIONS OF OPTIONAL FUNCTIONS

### ADVANCED SECURITY FUNCTION (/AS)

Security functions, electronic recording and electronic signature functions, and data integrity functions complying with FDA 21 CFR Part11 will be added.

- Enabling/disabling the advanced security function:  
You can enable or disable the advanced security function.
- \* The set values and data stored in the internal memory are initialized each time the function is enabled or disabled.
- Data anti-tamper function:  
Settings and measured data are saved as encrypted binary files.
- Data type:  
Only for display or event  
Trigger mode is not possible with event data.
- Login function:  
Using the login function described below, you can enter security settings on the instrument
  - User name
  - Password
  - User ID (depend on setting)
  - User level and number of users:  
System administrator (all can be operated), second administrator (Admin property and user property settings can be used to restrict executable operations and signatures.), General user (With user restrictions, you can set restrictions on performing operations and sign authority.), Monitor user (monitoring only), totally 100 users (GX20-2: 200 users)
    - Admin property setting: 10 kinds (for second administrator)
    - User restrictions setting: 10 kinds (for second administrator, general users)
- Password expiration time:  
select form Off, 1month, 3 month, 6month
- Advance notice of expiry date:  
A message encouraging the user to change the password is displayed when the user logs in during the specified notification period (Off, 5 days before, 10 days before).
- Password policy function:  
The minimum number of characters and the types of characters that must be included can be set.
- Password control function:  
Logins are verified by a Kerberos v5 authentication server\* (only user name and password)  
Encryption method:  
AES128-CTS-HMAC-SHA1-96  
AES256-CTS-HMAC-SHA1-96  
ARCFOUR-HMAC-MD5  
Pre-Auth function: use
  - \* The function has confirmed compatibility with Windows Server 2003 SP2/Windows Server 2008 SP2/Windows Server 2012/Windows server 2016 ActiveDirectory

- Signature function:  
After checking data that has finished being recorded, you can add three levels of electronic signature, select a pass/fail, and enter comments (50 characters maximum)
- Audit trail function:  
The operation log, the settings change log and the settings file when the change was made are saved.  
Comments that are entered when settings are changed or when an alarm is acknowledged are recorded in the event log. This allows you to check the comments and details of the setting changes.
- Measurement mode limitations  
High speed and Dual interval measurement modes are not supported.
- Module limitations  
PID control modules are not supported.

### SERIAL COMMUNICATION INTERFACE (/C2, /C3)

- Connection: EIA RS-232(/C2) or EIA RS-422/485(/C3)
- Protocol: Dedicated protocol, Modbus/RTU, or DARWIN compatible communication
- Setting/measurement server function: Operation, setting or output of measurement data are available by dedicated protocol.
- Synchronization: Start-stop synchronization
- Transmission mode (RS-422/485):  
RS-422: Four-wire half-duplex multi-drop connection (1:n (n = 1 to 31))  
RS485: Two-wire half-duplex multi-drop connection (1:n (n = 1 to 31))
- Baud rate: 1200, 2400, 4800, 9600, 19200, 38400, 57600, or 115200 bps
- Data length 7 or 8 bits
- Start bit: 1 bit
- Stop bit: 1 bit or 2 bit
- Parity: ODD, EVEN, or NONE
- Handshaking Off: Off, XON: XON, XON: RS, and CS: RS
- Communication distance;  
RS-422/485: 1200 m (57600 bps or less), 600 m (115200 bps)  
RS-232: 15 m  
Applicable cable: AWG24 to 16
- Modbus/RTU communication: Reading or writing of measurement data on other instruments is available by Modbus protocol.  
Communication channel function option (/MC) is needed to read measurement data from other instruments.
- Operation modes: Master or slave
- Execution of a communication command using a bar code: The entered text can be executed as a communication command.

## CUSTOM DISPLAY (/CG)

Using DXA170 DAQStudio, screen creation software, a custom screen can be constructed and displayed in which display components (such as trend, digital, and bar graphs) are freely placed. The screen data is transferred from DAQStudio to the internal memory via communication, or loaded from an external medium to the internal memory and displayed.

- Number of screens: 30 (internal memory)
- Display components:
  - Normal components (digital value, bar graph, tag No., tag comment, simple digital value, simple bar graph, alarm mark, unit, alarm indicator, lower-limit span value, upper-limit span value, group name, system icon, memory sample bar, date/time view, batch name, and user name)
  - Trend components (trend group display (with scale board))
  - List components (alarm list view and message list view)
  - Operation components (DO (DO operable), internal switch (internal switch operable), numeric value operations (viewing data of and writing data to communication channels), and button operations (writing numeric values, operating bits, switching screens, and executing communication commands))
  - Text components (labels)
  - Figure components (line view, rectangle view, and circle view)
  - Image components (PNG image data)
  - Batch components (Batch number, Lot number, Text field, Batch comment, Batch group number\*)
    - \* Only on GX with the Multi batch function (/BT option)
  - Control component (controller, control alarm indicator, external controller)
- Configuring screens: Screen creation software Creation using DXA170 DAQStudio (GX does not have a creation function)
- Saving/loading screen data: A specified screen or all the screens is/are loaded from an external storage medium to the internal memory, or a specified screen or all the screens in the internal memory is/are saved on an external storage medium.

## VGA VIDEO OUTPUT (/D5) (Only for GX20)

- External display:  
Resolution: 800 × 600 dots (VGA)  
Connector: 15-pin D-Sub (female)

## EtherNet/IP COMMUNICATION (PLC communication protocol) (/E1)

Can be joined to an Ethernet/IP network as an adapter (or a server).

- Loading data from the I/O channel or calculation channel (/MT), alarm status

Note: Control alarm status cannot be loaded.

I/O channel:

GX10: 100, GX20-1: 100, GX20-2: 500

Calculation channel:

GX10: 50, GX20-1: 100, GX20-2: 200

- Loading and writing data from/to the communication channel (/MC)  
Loading from the alarm status  
Communication channel:  
GX10: 50, GX20-1: 300, GX20-2: 500
- Implementation level: Level 2
- Operations that can be performed using explicit messages:  
Communication is performed using the CIP extension feature of the PLC-specific PCCC command by Rockwell Automation.  
Start and stop recording and computation  
Write batch information  
Write messages  
Load alarm status  
Write alarm setpoints and alarm types  
Alarm ACK  
Note: The following operations are not possible: load control alarm status, write control alarm setpoints and control alarm types, control alarm ACK.
- Supported protocols: EIP/PCCC, EIP/native
- Number of the simultaneous connection: Max. 10 (Explicit message)

## WT COMMUNICATION (/E2)

Collects data by connecting to WT equipment manufactured by Yokogawa Meters & Instruments Corp. via Ethernet communication\*.

\* The /MC option is required.

- Supported models: WT1800E (command type WT1800), WT1800, WT300E (command mode WT300), WT500, and WT300
- Number of connectable units:  
GX10: 8  
GX20: 16
- Communication cycle: 500 ms/1 s/2 s/5 s/10 s/20 s/30 s
- Types of data that can be obtained: Voltage, current, power, power factor, phase, electrical energy, high-frequency wave, etc.
- Number of data allocations  
GX20: 300  
GX10: 50

## FAIL OUTPUT (/FL)

- Contact: C contact, 1 point
- FAIL output:  
The relay contact output on the rear panel indicates the occurrence of CPU failure.  
Relay operation: Energized during normal operation and de-energized on CPU failure.
- Status output: The relay contact, which is de-energized in normal output state, is energized upon the occurrence of a memory/media error, measurement error, communication error, recording stop, or alarm.

- Rated power supply voltage: 24 V DC or 250 V AC or less
- Rated load current: 3A (DC)/3A (AC), resistance load
- Min. load current: 100 mA
- Recommended replacement periods of contact:  
Electrical: 30,000 more ON-OFF operations,  
Mechanical: 5,000,000 more ON-OFF operations

### Log SCALE (/LG)

A logarithmic voltage that has been converted from a physical value is applied to the GX, and then the GX's Log scale (logarithmic scale) is used to display and record the physical value.

- Input type: Log input (logarithmic input), Pseudo log input: An input that supports pseudo logs, Log linear input: Input that is linear on a logarithmic scale.
- Range: 20mV/60mV/200mV/1V/2V/6V/20V/50V/100V
- Scalable range:
  - Log input:  
1.00E-15 to 1.00E+15 (15decade maximum)  
Scale\_L < Scale\_U  
If the lower limit mantissa is 1.00, the difference between the exponents must be 1 or more.  
If the lower limit mantissa is a value other than 1.00, the difference between the exponents must be 2 or more.
  - Pseudo Log Input/Log linear input  
1.00E-15 to 1.00E+15 (15decade maximum)  
The higher limit mantissa is the same as the lower limit mantissa).  
If the lower limit mantissa is 1.00, the value must be between 1.00E-15 and 1.00E+15, the difference between the exponents must be 1 or more, and the maximum decades is 15.  
If the lower limit mantissa is a value other than 1.00, the value must be between 1.01E-15 and 9.99E+14, the difference between the exponents must be 1 or more and the maximum decades is 15.
- Alarm type: High limit, low limit, delay high limit, and delay low limit
- Alarm setting range: The range converted into the LOG scale corresponding to -5% to 105% of the span width.
- Alarm hysteresis: Fixed to 0
- Green band setting range: The lower limit to the upper limit of the scale. However, the lower limit of the display position must be smaller than the upper limit.
- Position of the decimal point: 1 to 2
- Misc: Nonlinear input is possible by correcting the input value

### MATHEMATICAL FUNCTIONS WITH REPORT FUNCTION (/MT)

#### Mathematical Function:

- Number of math channels; GX10: 50, GX20-1: 100, GX20-2: 200

Note) Note: Depending on the measurement mode, there is a limit to the number of math channels at scan intervals shorter than 100 ms. See "Limitations."

- Scan interval

Measurement mode	Scan interval
Normal	Scan interval
High speed	Scan interval
Dual interval	Master scan interval*

- \* When the measurement mode is Dual interval, this item sets which scan interval to use, the interval of measurement group 1 or that of scan group 2, for creating measured values of math or communication channels and other similar operations.
- Number of expressions:
- Operation:  
General arithmetic operations: Four arithmetic operations (+, -, \*, /), square root, absolute, common logarithm, natural logarithm, exponential, and power  
Relational operations: <, ≤, >, ≥, =, and ≠  
Logic operations: AND, OR, NOT, and XOR  
Statistical operations: TLOG (maximum, minimum, average, sum, P-P values of time series data) or CLOG (maximum, minimum, average, sum, P-P values of a specified channel)  
Special operations: PRE, HOLD, RESET, and CARRY  
Conditional operation: [a?b:c]  
Bit operation: BIT  
Integer extracting operation: INT  
Remainder extracting operation: MOD  
Trigonometric functions: SIN, COS  
CP operations: CP.02, CP.CO2
- Computation accuracy: Double-precision floating point
- Data that can be used;  
Channel data: Measurement channels (0001 to 6516), mathematical channels (GX10: A001 to A050, GX20-1: A001 to A100, GX20-2: A001 to A200), Communication channels (GX10: C001 to C050, GX20-1: C001 to C300, GX20-2: C001 to C500), Communication channels raw data (GX10: RC001 to RC050, GX20-1: C001 to C300, GX20-2: RC001 to RC500), Constants:-K001 to K100, Variable constant: W001 to W100, Internal switch: S001 to S100, Flag: F01 to F20, Recording state (REC01), Integer data: Z000 to Z999

**Logic math function:**

- A function that outputs calculated results as 0 or 1 to DOs or internal switches
- Number of logic calculations maths:  
GX10: 20, GX20-1/GX20-2: 50
  - Expression: Up to 120 characters
  - Computation type: Basic arithmetic, relational, logical, conditional, bit
  - Data that can be used: All channel data
  - Logic math: LM001 to LM020 (GX10), LM001 to LM050 (GX20-1/GX20-2)
  - Output destination: DO channels, internal switches (only when set to Manual in either case)
  - Setting change: Cannot be changed during recording
  - Math interval: 100 ms (fastest)

**Report function:**

- Number of report channels; GX10: 50, GX20: 60
- Note) Depending on the measurement mode, there is a limit to the number of report channels at scan intervals shorter than 100 ms. See "Limitations."
- Scan interval

Measurement mode	Scan interval
Normal	Scan interval
High speed	Scan interval
Dual interval	Scan interval of each measurement group

- Report types: Hourly + daily, daily + weekly, daily + monthly, Batch, Day custom
- Computation types: Average, maximum, minimum, sum, or instantaneous value
- Unit of sum: OFF, /s, /min, /hour, /day
- Report templates: Office Open XML spreadsheet files (which can be displayed with Microsoft Office Excel) or PDF files can be output or printed out with any LAN-connected printer supporting the HP PCL5c language and the port 9100.

**COMMUNICATION CHANNEL FUNCTIONS (/MC)\***

- Number of communication channels;  
GX10: 50 (C001 to C050)  
GX20-1: 300 (C001 to C300)  
GX20-2: 500 (C001 to C500)
- Note) Depending on the measurement mode, there is a limit to the number of communication channels at scan intervals shorter than 100 ms. See "Limitations."  
The minimum communication channel update interval is 100 ms.
- Scan interval

Measurement mode	Scan interval
Normal	Scan interval
High speed	Scan interval
Dual interval	Master scan interval

- \* Required to record data from EtherNet/IP (/E1), Modbus devices, or PCs on the GX and to write data in the remote device from the GX via Modbus.
- Calibration correction  
Mode: Linearizer Approximation, Linearizer Bias, Correction factor\*  
Number of set points: 2 to 12
- \* Only when the /AH option is installed

**24 V DC/AC POWER SUPPLY (/P1)**

- Rated power supply: 24 V DC/24 V AC (50/60 Hz)
- Allowable power supply voltage range: 21.6 to 26.4 V DC/AC
- Insulation resistance: 20 MΩ or greater at 500 V DC between power terminal and earth
- Withstand voltage: 500 V AC at 50/60 Hz for one minute between power terminal and earth
- Rated power supply frequency (for AC): 50/60 Hz
- Allowable power supply frequency (for AC): 50 Hz  $\pm$  2%, 60 Hz  $\pm$  2 %
- Influence of power supply voltage variation: Variations of the measured value must be within  $\pm$ 1 digit in the range from 21.6 to 26.4 VAC/DC.
- Influence of power supply frequency variation (for AC): Variations of the measured value must be within  $\pm$ (0.1% of rdg + 1 digit) at a rated frequency of  $\pm$ 2 Hz.
- Power consumption:

Supply voltage	LCD backlight off	Normal operation	Maximum
24 V DC	GX10: 7 VA GX20: 13 VA	GX10: 9 VA GX20: 16 VA	GX10: 24 VA GX20: 48 VA
24 V AC	GX10: 14 VA GX20: 25 VA	GX10: 17 VA GX20: 29 VA	GX10: 42 VA GX20: 76 VA

\* The following combinations are assumed for LCD backlight off and normal operation.

GX10: 1 AI module, 1 DO module, 1 DI module  
GX20: 5 AI modules, 4 DO modules, 1 DI module

- Module power supply voltage: The total allowable power consumption of respective modules is up to 6 W in the GX10 and up to 20 W in the GX20.

**USB INTERFACE (/UH)**

- USB port: Complies with USB 2.0 and host function
  - Number of ports: 2 (one each on the front panel and rear panel)
  - Connectable devices: Only connect the devices listed below to prevent damage to the devices.
    - Keyboard: Complies with HID Class Ver. 1.1 104/89 keyboard (US) and 109/89 keyboard (Japanese)
    - Mouse: Complies with HID Class Ver. 1.1
    - External medium: USB flash memory  
FAT16 or FAT32 format with a 32 KB or smaller cluster size.  
Does not guarantee the operation of all USB flash memories  
External medium such as a hard disk, ZIP, MO, and optical discs are not supported.
    - Barcode reader: USB HID Class Ver. 1.1 compatible  
English (U.S.) standard USB keyboard compatible
  - Execution of a communication command using a bar code: The entered text can be executed as a communication command.
  - Power supply: 5 V  $\pm$ 10%, 500 mA \*1
- \*1: Devices which need more than 500 mA total bus power for 2 ports cannot be connected at the same time.  
For low powered devices (bus power < 100 mA):  
5V  $\pm$  5%  
For high powered devices (bus power < 500 mA):  
5V  $\pm$  10%



**BLACK COVER (/BC)**

Front door color: Charcoal grey light (Munsell 10B3.6/0.3 equivalent)

**AEROSPACE HEAT TREATMENT (/AH)**

Supports heat treatment application AMS2750/ NADCAP.

Schedule management for periodically executing calibration correction configuration and the like.

In correction coefficient mode of calibration correction, two biases can be specified: one based on thermocouple and another based on device

- Number of manageable schedules  
GX20-1:6  
GX20-2: 12
- Calibration correction mode:  
Off, Linearizer approximation, Linearizer bias, correction factor
- Number of set points: 2 to 12
- Notification contents  
Title, Notification message, Due date  
Notification buzzer can be sounded.

**MULTI-BATCH FUNCTION (/BT)**

Recording start/stop and data file creation is possible for each batch.

- Number of multi-batches:  
GX10/GX20-1: max. 6, GX20-2: max. 12
- Batch single operation: Memory start/stop, math reset, message writing
- Batch overview operation: Computation start/stop, report start/stop, manual sampling, setup data save/load
- Scan interval: 500ms, 1 s, 2 s, 5 s (common to all batches)
- Data type: Display or event only Trigger mode not available for event data.
- Recording interval: Common to all batches
- Data file: Display or event data file created for each batch
- Number of display groups:  
GX10: 6 max. per batch  
Number of channels per group: 10  
GX20-1: 6 max. per batch  
Number of channels per group: 20  
GX20-2: 12 max. per batch  
Number of channels per group: 20  
Channels assigned to the display group of each batch and those set as recording channels are recorded to data files.
- Batch single settings: Group, trip line, file header, data file name, text field, batch number, lot number
- Measurement mode limitations  
High speed and Dual interval measurement modes are not supported.

**OPC-UA SERVER (/E3)**

Data acquired by the GX can be accessed through Ethernet communication from a host system (OPC-UA client).

- Communication  
Mode: OPC-UA Server  
Encoding: UA Binary  
Protocol: OPC UA TCP  
Maximum number of connections: 3 sessions  
Profile Micro Embedded Device Server
- Security  
Type: None  
Encryption: None  
Login: Anonymous, Username
- Data acquisition:  
Measurement value, alarm status, and alarm value  
Computation value, alarm status, and alarm value  
Communication value, alarm status, and alarm value  
Batch information  
PV, SP, OUT, R/S, A/M/C, R/L, Alarm status in loop
- Data writing: Measurement channel (DO channel only), communication channel, alarm value, batch information, OUT, R/S, A/M/C, R/L
- Other acquired information: Device name, serial number, time, device status
- Port number: 4840 (changeable: 1 to 65535)
- Number of items:  
GX10: 100 max. (MonitoredItem/Session)  
GX20: 300 max. (MonitoredItem/Session)
- Fastest period:100ms
- Service set:

Discovery	FindServers, GetEndpoints
SecureChannel	OpenSecureChannel, CloseSecureChannel
Session	CreateSession, ActivateSession, CloseSession
View	Browse, BrowseNext, TranslateBrowsePathsToNodeIds
Attribute	Read, Write
MonitoredItem	CreateMonitoredItems, ModifyMonitoredItems, DeleteMonitoredItems, SetMonitoringMode
Subscription	CreateSubscription, ModifySubscription, DeleteSubscriptions, Publish, Republish, SetPublishingMode

---

## SLMP COMMUNICATION (Mitsubishi PLC) (/E4)

CC-Link family SLMP communication protocol function, which enables connection from a GX to Mitsubishi Electric PLCs without sequencer programs.

The GX operates as an SLMP client. Writing GX measurement data to a PLC and reading PLC data into communication channels\* are possible.

\* The communication channel function (/MC option) is required.

- Number of connection destination servers: 16 max.
- Read cycle: 100ms/200ms/500ms/1s/2s/5s/10s/20s/30s/1min
- Number of commands that can be registered  
GX10: 50  
GX20-1: 100  
GX20-2: 200
- Communicable internal data:  
Special relay (SM), special register (SD), input (X), output (Y), internal relay (M), latch relay (L), annunciator (F), edge relay (V), link relay (B), data register (D), link register (W), timer contact (TS), timer coil (TC), current timer value (TN), integration timer contact (SS), integration timer coil (SC), current integration timer value (SN), counter contact (CS), counter coil (CC), current counter value (CN), special link relay (SB), special link register (SW), direct access input (DX), direct access output (DY), index register (Z), file register (R, ZR), extended data register (D), extended link register (W)

Device code is indicated in parentheses.

## Program control function (/PG)

See GX90UT PID Control Module General Specifications (GS 04L53B01-31EN)

## ■ Limitations

### System limitations

#### Maximum number of channels

System	Measurement mode	Maximum number of module connections	Maximum number of channels			
			Input/output	Communication	Math	Report
GX10	Normal	10	100	50	50	50
	High speed	3	12	50	50	50
	Dual interval	10	50	25	25	25
GX20-1	Normal	10	100	300	100	60
	High speed	10	40	300	100	60
	Dual interval	10	50	150	50	30
GX20-2	Normal	45	500	500	200	60
	High speed	10	40	500	200	60
	Dual interval	45	250	250	100	30

#### Limit to the number of expandable I/O units or GM sub units

- Up to six units can be connected.
- Connection is not possible if the measurement mode is set to High speed.

#### Limit to the number of GX main unit modules

Module	GX10	GX20-1	GX20-2
When GX90XA-04-H0 and GX90YA are included	No limit	9	9
When GX90UT is included	No limit	8	8

#### Limit on Modules

- Up to 10 modules consisting of GX90YD, GX90WD, and GX90UT can be installed into the system.
- One GX90WD module can be installed in a GX. One module can be installed in a GX60 (expandable I/O) and each GM sub unit.
- One GX90YA module can be installed in a GX10. Two modules can be installed in each of the GX20, GX60 (expandable I/O) and GM sub unit.
- Up to 10 GX90YA modules can be installed in a GX10/GX20-1 system and up to 12 in a GX20-2 system.
- If the measurement mode is High speed, a GX90XD or GX90WD module can be installed in the system.
- If the measurement mode is High speed, only GX90XA-04-H0 (high-speed AI), GX90XD (DI), and GX90WD (DIO) are detected. DI and DIO are fixed to remote mode. Measurement and recording are not possible.
- If the measurement mode is Dual interval, GX90UT is not detected.

#### Limit to the Number of Measurement Channels

The following limitation applies to the number of channels that can measure at scan intervals shorter than 100 ms. If the measurement mode is Dual interval, the limitation applies at the scan group level. However, there are scan intervals you cannot set.

#### • Measurement mode is High speed

##### GX10

Channel	Scan interval					
	1 ms	2 ms	5 ms	10 ms	20 ms	50 ms
Input/output	1	2	5	10	12	12
math	–	1	2	5	10	25
communication	–	1	2	5	10	25
Report	–	1	2	5	10	25



**GX20-1**

Channel	Scan interval					
	1 ms	2 ms	5 ms	10 ms	20 ms	50 ms
Input.output	1	2	5	10	20	40
math	1	2	5	10	20	50
communication	3	6	15	30	60	150
Report	1	2	5	10	20	50

**GX20-2**

Channel	Scan interval					
	1 ms	2 ms	5 ms	10 ms	20 ms	50 ms
Input.output	5	10	25	40	40	40
math	2	4	10	20	40	100
communication	5	10	25	50	100	250
Report	2	4	10	20	40	60

- Measurement mode is Dual interval

**GX10**

Channel	Scan interval					
	1 ms	2 ms	5 ms	10 ms	20 ms	50 ms
Input.output	–	–	5	10	12	12
math	–	–	1	2	5	12
communication	–	–	1	2	5	12
Report	–	–	1	2	5	12

**GX20-1**

Channel	Scan interval					
	1 ms	2 ms	5 ms	10 ms	20 ms	50 ms
Input.output	–	–	5	10	20	40
math	–	–	2	5	10	25
communication	–	–	7	15	30	75
Report	–	–	2	5	10	25

**GX20-2**

Channel	Scan interval					
	1 ms	2 ms	5 ms	10 ms	20 ms	50 ms
Input.output	5	10	25	40	40	40
math	1	2	5	10	20	50
communication	2	5	12	25	50	125
Report	1	2	5	10	20	30

## Limit to the Number of Recording Channels in Each Measurement Mode

I/O channel + math channel + communication channel

Model	Measurement mode	Recording interval										
		1ms	2 ms	5 ms	10 ms	20 ms	50 ms	100 ms	200 ms	500 ms	1 s or more	
GX10	Normal	–	–	–	–	–	–	–	100	100	100	100
	High speed	1	4	9	20	32	62	100	100	100	100	
	Dual interval	–	–	5	10	20	36	100	100	100	100	
GX20-1	Normal	–	–	–	–	–	–	100	200	500	500	
	High speed	2	4	10	20	40	100	100	200	500	500	
	Dual interval	–	–	5	10	20	50	100	100	250	250	
GX20-2	Normal	–	–	–	–	–	–	500	500	1000	1000	
	High speed	10	20	50	100	150	150	200	500	1000	1000	
	Dual interval	5	10	25	40	50	50	100	20	600	600	

Note) Number of active recordable channels.

### Notes on Module Installation

- When the reference junction compensation of this product is used with the thermocouple input of a GX90XA-10-U2, GX90XA-10-L1, GX90XA-10-T1, GX90XA-10-V1 or GX90XA-04-H0, if the following module is installed to the right (slot with the smaller number) of the GX90XA module as seen from the GX rear panel, the reference junction compensation accuracy of that module may deviate from the guaranteed range (except when GX90XA-04-H0 is installed to adjacent slots).  
GX90XA-10-C1, GX90XA-04-H0, GX90WD, GX90YA, GX90UT
- On the GX20, when the reference junction compensation of this product is used with the thermocouple input of a GX90XA-10-U2, GX90XA-10-L1, GX90XA-10-T1, GX90XA-10-V1 or GX90XA-04-H0, if the following module is installed above, below, to the right, or to the left (slot with the smaller number) of the GX90XA module as seen from the GX rear panel, the reference junction compensation accuracy of that module may deviate from the guaranteed range.  
GX90YA, GX90UT
- If you want to use the DI of a GX90XD or GX90WD, only a single module installed in the GX main unit can be used.
- If the maximum number of I/O channels are assigned and the last channel is assigned to an intermediate channel of a connected I/O module, that module and subsequent modules will not be recognized.

#### Example GX10/GX20-1

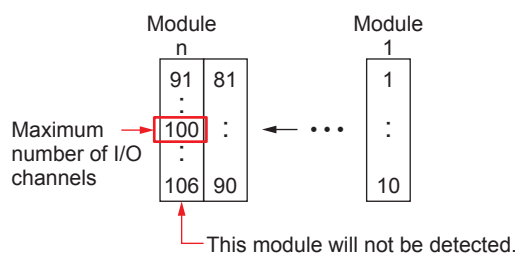

### Dual Interval File Searching of Universal Viewer

Recording mode	Link dual interval waveform <sup>*1</sup>	Show dual interval integrated link view <sup>*2</sup>
Free + Free	✓	✓
Free + Trigger (single/repeat)	–	–
Trigger (single/repeat) + Trigger (single/repeat)	–	–

\*1 Link dual interval waveform: A function that searches a folder for and displays the file that forms a pair with the displayed file.

\*2 Show dual interval integrated link view: A function that displays from the result of Search Open one of the files that forms a pair and displays both trends when it is clicked.

### PID program pattern setting from the Web application

You cannot set from the Web application. Hardware Configurator is required for setting program patterns.

## INPUT/OUTPUT MODULE SPECIFICATIONS

### ANALOG INPUT MODULE (Model GX90XA or Option /Uxx0)

### DIGITAL INPUT MODULE (Model GX90XD or Options /CRx1)

### DIGITAL OUTPUT MODULE (Model GX90YD, or Options /CR1x, /CR2x, /CR4x)

### DIGITAL INPUT/OUTPUT MODULE (Model GX90WD)

### PULSE INPUT MODULE (Model GX90XP)

### ANALOG OUTPUT MODULE (Model GX90YA)

### PID CONTROL MODULE (Model GX90UT)

Please see GX90XA/GX90YA/GX90XD/GX90YD/GX90WD/GX90XP Input/Output Module (GS 04L53B01-01EN) and PID Control (GS 04L53B01-31EN) General Specification.

## APPLICATION SOFTWARE

### SMARTDAC+ STANDARD

- Universal viewer
- Hardware configurator (with Program pattern setting)

Download the latest version of the software from the following URL;

[www.smartdacplus.com/software/en/](http://www.smartdacplus.com/software/en/)

### Operating environment

#### OS:

OS	Type
Windows 7	Home Premium SP1 (32-bit and 64-bit Editions)
	Professional SP1 (32-bit and 64-bit Editions)
Windows 8.1	Update
	Pro Update
Windows 10	Home (32-bit and 64-bit Editions)
	Pro (32-bit and 64-bit Editions)
	Enterprise (32-bit and 64-bit Editions)
	Enterprise LTSB (32-bit and 64-bit Editions)

Yokogawa will also stop supporting OSs that Microsoft Corporation no longer supports.

### Processor and main memory:

OS	Processor and main memory
Windows 7 Windows 8.1 Windows 10	32-bit edition Intel Pentium 4, 3GHz or faster x64 or x86, 2GB or more 64-bit edition Intel x64 processor that is equivalent to Intel Pentium 4, 3 GHz or faster, 2GB or more

### Browser:

Supported browser: Windows Internet Explorer 11  
HTTP1.1 and JavaScript are used.

### Hard disk:

- 100MB or more of free space

### Display:

- A video card that is recommended for the OS and a display that is supported by the OS, has a resolution of 1024 x 768 or higher, and that can show 65,536 colors (16-bit, high color) or more.

### Universal Viewer software

The universal viewer can display the following data generated by the recorder on the screen and print it out on the printer.

- Display data file
- Event data file
- Report data file (Including Hour, Day, Week Month)
- Manual sample data file

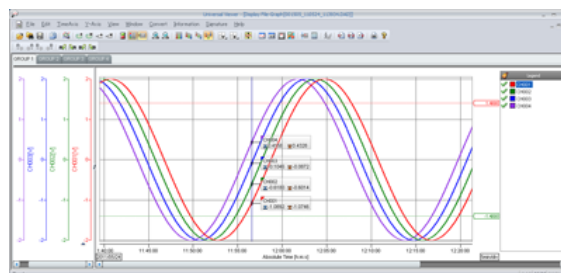

- Viewer function  
Waveform display, digital display, circular display, list display, report display, operation log display etc.
- Data conversion:  
File conversion to ASCII or MS-Excel format
- Signin function

### Web application/Hardware configurator

- Online setting on Web browser
  - Offline setting on Web browser
- Settings can be made using browsers such as Internet Explorer 11, Chrome (Excluding Hardware configurator).

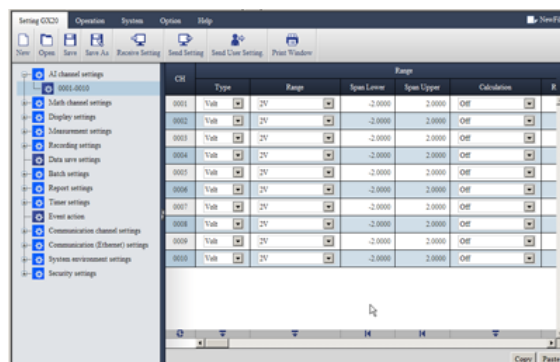

## MODEL AND SUFFIX CODES

Model	Suffix Code	Optional code	Description
GX10			Paperless recorder (Panel mount type, Small display) <sup>*13</sup>
GX20			Paperless recorder (Panel mount type, Large display) <sup>*13</sup>
Type	-1		Standard (Max. measurement channels: 100 ch)
	-2		Large memory (Max. measurement channels: 500 ch) <sup>*12</sup>
Display language	E		English, degF, DST (summer/winter time) <sup>*10</sup>
Optional features	/AH		Aerospace heat treatment
	/AS		Advanced security function (Part 11) <sup>*21</sup>
	/BC		Black cover
	/BT		Multi-batch function <sup>*22</sup>
	/C2		RS-232 <sup>*1</sup>
	/C3		RS-422/485 <sup>*1</sup>
	/CG		Custom display <sup>*15</sup>
	/D5		VGA output <sup>*2</sup>
	/E1		EtherNet/IP communication (PLC communication protocol) <sup>*18</sup>
	/E2		WT communication <sup>*14</sup>
	/E3		OPC-UA server
	/E4		SLMP communication (Mitsubishi PLC) <sup>*19</sup>
	/FL		Fail output, 1 point
	/LG		Log scale
	/MT		Mathematical function (with report function) <sup>*16</sup> <sup>*17</sup>
	/MC		Communication channel function <sup>*20</sup>
/P1		24 V DC/AC power supply	
/PG		Program control function <sup>*23</sup>	
/UH		USB interface (Host 2 ports)	

### Analog input module, Digital I/O module:

Please add the following suffix codes to the main unit model and specification codes.

Option	Optional code	Description
Optional features (Analog input) <sup>*3</sup> <sup>*11</sup>	/UC10	With analog input module, 10ch (Clamp terminal)
	/UC20	With analog input module, 20ch (Clamp terminal) <sup>*7</sup>
	/UC30	With analog input module, 30ch (Clamp terminal) <sup>*8</sup>
	/UC40	With analog input module, 40ch (Clamp terminal) <sup>*5</sup>
	/UC50	With analog input module, 50ch (Clamp terminal) <sup>*5</sup>
	/US10	With analog input module, 10ch (M3 screw terminal)
	/US20	With analog input module, 20ch (M3 screw terminal) <sup>*7</sup>
	/US30	With analog input module, 30ch (M3 screw terminal) <sup>*8</sup>
	/US40	With analog input module, 40ch (M3 screw terminal) <sup>*5</sup>
	/US50	With analog input module, 50ch (M3 screw terminal) <sup>*5</sup>
Optional features (Digital I/O) <sup>*4</sup>	/CR01	With digital I/O module, (Output:0, Input:16) <sup>*8</sup> <sup>*9</sup> <sup>*16</sup>
	/CR10	With digital I/O module, (Output:6, Input:0) <sup>*8</sup>
	/CR11	With digital I/O module, (Output:6, Input:16) <sup>*7</sup> <sup>*8</sup> <sup>*9</sup> <sup>*16</sup>
	/CR20	With digital I/O module, (Output:12, Input:0) <sup>*6</sup>
	/CR21	With digital I/O module, (Output:12, Input:16) <sup>*6</sup> <sup>*9</sup> <sup>*16</sup>
	/CR40	With digital I/O module, (Output:24, Input:0) <sup>*6</sup>
	/CR41	With digital I/O module, (Output:24, Input:16) <sup>*6</sup> <sup>*9</sup> <sup>*16</sup>

\*1 /C2 and /C3 cannot be specified together.

\*2 /D5 can be specified only for the GX20.

\*3 Only one option can be specified.

- \*4 Only one option can be specified.
- \*5 /UC40, /UC50, /US40 and /US50 cannot be specified for the GX10.
- \*6 /CR20, /CR21, /CR40 and /CR41 cannot be specified for the GX10.
- \*7 If /UC20 or /US20 is specified, /CR11 cannot be specified for the GX10.
- \*8 If /UC30 or /US30 is specified, /CR01, /CR10 and /CR11 cannot be specified for the GX10.
- \*9 Digital input module have M3 screw terminals.
- \*10 The Display language is selectable from English, German, French, Russian, Korean, Chinese, Italian, Japanese.  
To confirm the current available languages, please visit the following website.  
URL: <http://www.yokogawa.com/ns/language/>
- \*11 Universal type (Type Suffix Code: -U2). If you need the electromagnetic relay type (Type Suffix Code: -T1), current (mA) input (Type Suffix Code: -C1) type, L-model DCV/TC/DI, scanner type (Type Suffix Code: -L1), High-speed universal type (Type Suffix Code: -H0), 4-wire RTD/resistance type (Type Suffix Code: -R1), purchase it separately.
- \*12 Large memory type can be specified only for the GX20.
- \*13 To connect an expandable I/O, GM sub unit, you will need one expansion module for the GX.
- \*14 /MC option must be separately specified when the WT communication is selected.
- \*15 Creating custom displays requires DXA170 DAQStudio (sold separately). (GX does not have a creation function.)
- \*16 Optional code /MT (MATH) required if using the GX90XD's or GX90WD's pulse input.
- \*17 The /MT option (computation) is required to perform pulse integration on GX90XP pulse input modules.
- \*18 If you want to write from a PLC to the GX via EtherNet/IP communication, a separate communication channel (/MC) is required.
- \*19 A separate communication channel (/MC) is required to perform SLMP communication.
- \*20 A communication channel (/MC) is required to configure the Modbus client function and for other devices to write to the GX Modbus server.
- \*21 When the advanced security function is set to ON, the scan interval is set to 100 ms or longer. In addition, the dual interval function and PID modules cannot be used.
- \*22 When the multi-batch function is set to ON, the scan interval is set to 500 ms or longer. In addition, the dual interval function cannot be used.
- \*23 A PID control module is required to use the program control function.

### Module installation positions of analog input modules and digital I/O modules when they are preinstalled

#### GX10

Module type	Optional code	Slot number		
		2	1	0
Analog Input (GX90XA-10-U2)	/UC10 or /US10	---	---	AI
	/UC20 or /US20	---	AI	AI
	/UC30 or /US30	AI	AI	AI
Digital I/O (GX90XD, GX90YD)	/CR01	---	---	DI
	/CR10	---	---	DO
	/CR11	---	DO	DI
Analog Input (GX90XA-10-U2 + Digital I/O (GX90XD, GX90YD)	/UC10 or /US10, /CR01	---	DI	AI
	/UC10 or /US10, /CR10	---	DO	AI
	/UC20 or /US20, /CR01	DI	AI	AI
	/UC20 or /US20, /CR10	DO	AI	AI

- Analog input modules specified with /U □□ 0 are installed in slots 0 to 2.
- Digital input and digital output modules specified with /CR □□ are installed in slots 0 and 1.  
The digital input module is installed with higher precedence than the digital output module.
- If both /U □□ 0 and /CR □□ are specified, the modules are installed to slots 0 to 2 in the following order of precedence: analog input, digital input, digital output.
- AI: GX90XA-10-U2N- □ N, DI: GX90XD-16-11N-3N, DO: GX90YD-06-11N-3N

#### Slot number

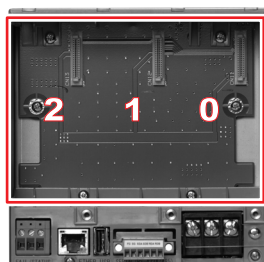

GX10 Rear

## GX20

Module type	Optional code	Slot number				
		9	8	7	6	5
		4	3	2	1	0
Analog Input (GX90XA-10-U2)	/UC10 or /US10	---	---	---	---	---
		---	---	---	---	AI
	/UC20 or /US20	---	---	---	---	---
		---	---	---	AI	AI
	/UC30 or /US30	---	---	---	---	---
		---	---	AI	AI	AI
	/UC40 or /US40	---	---	---	---	---
		---	AI	AI	AI	AI
	/UC50 or /US50	---	---	---	---	---
		AI	AI	AI	AI	AI
Digital I/O (GX90XD, X90YD)	/CR01	---	---	---	---	DI
		---	---	---	---	---
	/CR10	---	---	---	---	DO
		---	---	---	---	---
	/CR11	---	---	---	DO	DI
		---	---	---	---	---
	/CR20	---	---	---	DO	DO
		---	---	---	---	---
	/CR21	---	---	DO	DO	DI
		---	---	---	---	---
	/CR40	---	DO	DO	DO	DO
		---	---	---	---	---
	/CR41	DO	DO	DO	DO	DI
		---	---	---	---	---

- Analog input modules specified with /U □□ 0 are installed in slots 0 to 2.
- Digital input and digital output modules specified with /CR □□ are installed in slots 0 and 1.  
The digital input module is installed with higher precedence than the digital output module.
- If both /U □□ 0 and /CR □□ are specified, each module is installed in its corresponding position.
- AI: GX90XA-10-U2N- □ N, DI: GX90XD-16-11N-3N, DO: GX90YD-06-11N-3N

Slot number

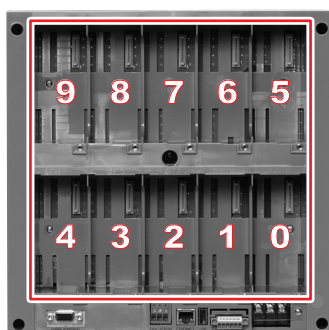

GX20 Rear

Analog input/output module, Digital I/O module (sold separately):

MODEL and SUFFIX Code (GX90XA)

MODEL and SUFFIX Code (GX90XD)

MODEL and SUFFIX Code (GX90YD)

MODEL and SUFFIX Code (GX90WD)

MODEL and SUFFIX Code (GX90XP)

MODEL and SUFFIX Code (GX90YA)

MODEL and SUFFIX Code (GX90UT)

Please see GX90XA/GX90YA/GX90XD/GX90YD/GX90WD/GX90XP Input/Output Module (GS 04L53B01-01EN) and PID Control Module (GS 04L53B01-31EN) General Specification.

When connecting the Expandable I/O

Please see GX60 Expandable I/O, GX90EX Expansion Module General Specification (GS 04L53B00-01EN.)

### ■ Standard Accessories

Product	Qty
Mounting bracket (for GX10 or GX20)	2
SD memory card (1GB)	1
Stylus pen (touch pen)	1
Tag sheet (for GX10 or GX20)	1
Sheet (for GX10 or GX20)	1
Dummy cover (For empty slots)	-

### ■ Application Software (Sold Separately)

Model	Description	OS
DXA170	DAQStudio	Windows 7/8/8.1/10
GA10	Data Logging Software	Windows 7/8.1/10 Windows Server 2008/2012/2016

### ■ Optional Accessories (Sold Separately)

Product	Model/part no.
Model SD memory card (1GB)	773001
Mounting bracket	B8740DY
Stylus pen (touch pen)	B8740BZ
Shunt resistor for M3 terminal (250 Ω ± 0.1 %)	415940
Shunt resistor for M3 terminal (100 Ω ± 0.1 %)	415941
Shunt resistor for M3 terminal (10 Ω ± 0.1 %)	415942
Shunt resistor for Clamp terminal (250 Ω ± 0.1 %)	438920
Shunt resistor for Clamp terminal (100 Ω ± 0.1 %)	438921
Shunt resistor for Clamp terminal (10 Ω ± 0.1 %)	438922
Dummy cover	B8740CZ
Validation Documents (For /AS option) *1	773230

\*1 Provision of Validation Documents  
A license sheet containing the license key required for installation is provided.  
Download the validation document from the following URL.  
<http://www.smartdacplus.com/software/en/>

**Calibration certificate (sold separately)**

When ordering the GX10/GX20 with options (analog input), the calibration certificate for the modules is included in and shipped with the calibration certificate of the main unit. When ordering an analog input module separately, each module gets its own calibration certificate (one certificate per module).

**Test certificate (QIC, sold separately)**

When ordering the GX10/GX20 with options (analog/digital I/O), the QIC for each module is included in and shipped with the QIC of the main unit. When ordering analog input modules and digital I/O modules separately, each module gets its own QIC (one QIC per module).

**User's Manual**

Product user's manuals can be downloaded or viewed at the following URL. To view the user's manual, you need to use Adobe Reader 7 or later by Adobe Systems.

**URL:** [www.smartdacplus.com/manual/en/](http://www.smartdacplus.com/manual/en/)

**Product Purchase Specifications**

The GX10/GX20 is composed of the main unit, I/O modules, Expandable I/O, and Expansion module.

There are two ways to purchase I/O modules.

One way is to purchase them individually by specifying models GX90XA, GX90XD, GX90YD, GX90WD, and GX90XP, GX90YA, GX90UT.

The other way is to purchase them as an option (/UCxx or /USxx). Purchasing them as an option is convenient, but this places limitations on the number of analog inputs that you can obtain.

If you want to use more than 50 channels, please purchase the I/O modules individually.

To connect expandable I/O (GX60), GM sub unit to GX10 or GX20, you must purchase one unit of expansion module (GX90EX) for GX10/GX20 in addition to the expandable I/O, GM sub unit.

**Trademarks**

The TCP/IP software used in this product and the document for that TCP/IP software are based in part on BSD networking software, Release 1 licensed from The Regents of the University of California.

- SMARTDAC+ is trademarks of Yokogawa Electric Corporation.
- Microsoft, MS and Windows are registered trademarks of Microsoft Corporation USA.
- Pentium are registered trademarks of Intel Corporation.
- Modbus is a registered trademark of AEG Schneider.
- Kerberos is a trademark of MIT.
- Other company and/or product names are registered trade mark of their manufactures.



## ■ MODEL SELECTION GUIDE

### Selection of the system configuration and GX10, GX20 type

Model-Type	Internal memory	Number of input/output channels	
		Main unit only	Main + expandable I/O
GX10	500 MB	48 ch (30 ch)	100 ch
GX20-1	500 MB	100 ch	100 ch
GX20-2	1.2 GB	100 ch	500 ch (450 ch)

\* The values inside parentheses are for when only analog input channels are available.

### I/O Modules

Model	Suffix code	Product name	Description	Number of channels	Measurement interval (shortest)
GX90XA	-10-C1N-□N	Analog Input Module	Current (mA) input DC current (mA), DC current standard signal (4-20mA)	10	100 ms
	-10-L1N-□N		Low withstand voltage relay DC voltage, standard signal, thermocouple (TC), DI (voltage, contact), and DC current (by adding an external shunt resistor)		500 ms
	-10-U2N-□N		Universal input DC voltage, standard signal, thermocouple (TC), resistance temperature detector (RTD), DI (voltage, contact), and DC current (by adding an external shunt resistor)		100 ms
	-10-T1N-□N		Electromagnetic relay DC voltage, standard signal, thermocouple (TC), DI (voltage, contact), and DC current (by adding an external shunt resistor)		1 s
	-10-V1N-□N		High withstand voltage DC voltage, standard signal, thermocouple (TC), DI (voltage, contact), and DC current (by adding an external shunt resistor)		100 ms
	-04-H0N- □ N		High-speed universal input DC voltage, standard signal, thermocouple, resistance temperature detector (RTD), DI (voltage, contact), DC current (when an external shunt resistor is connected)		4
	-06-R1N- □ N		4-wire RTD, 4-wire resistance	6	100 ms
GX90XD	-16-11N-□N	Digital Input Module	Remote control input, pulse input	16	100 ms
GX90XP	-10-11N-□N	Pulse Input Module	Pulse input (flow sum and the like)	10	100 ms
GX90YD	-06-11N-3N	Digital Output Module	Alarm output, etc	6	100 ms (update interval)
GX90WD	-0806-01N-3N	Digital Input/Output Module	Remote control input, pulse input	DI: 8 DO: 6	100 ms
GX90YA	-04-C1N-□N	Analog Output Module	Transmission output, manual output	4	100 ms(update interval)
GX90UT	-02-11N-3N	PID Control Module	Control of temperature, flow, pressure etc.	2 loops	100 ms(update interval)

## GX10 System Configuration (up to 100 channels)

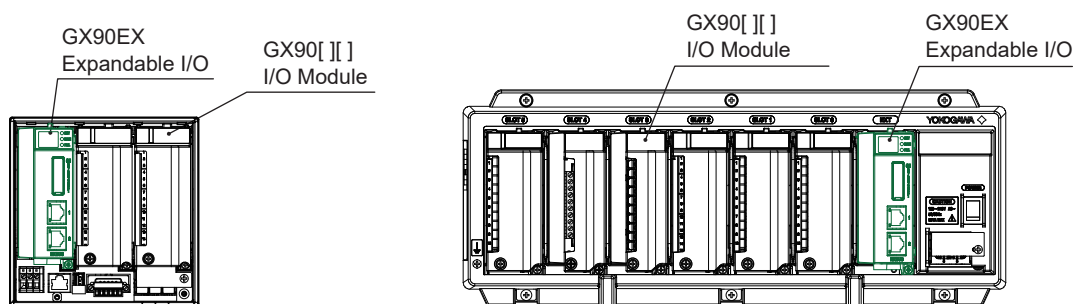

**GX10 Configuration example (maximum)**

- GX10: 1
- GX90[ ]: 2
- GX90EX: 1

**GX60 Configuration example (maximum)**

- GX60: 2
- GX90[ ]: 8
- GX90EX: 2 (Already installed in the GX60)

GX10  
(Unit 0)

SLOT 2	SLOT 1	SLOT 0
GX90EX	GX90[ ]	GX90[ ]

Expandable I/O)  
GX60  
(Unit 1)

SLOT 5	SLOT 4	SLOT 3	SLOT 2	SLOT 1	SLOT 0	EXT
GX90[ ]	GX90[ ]	GX90[ ]	GX90[ ]	GX90[ ]	GX90[ ]	GX90EX

Expandable I/O)  
GX60  
(Unit 2)

SLOT 5	SLOT 4	SLOT 3	SLOT 2	SLOT 1	SLOT 0	EXT
---	---	---	---	GX90[ ]	GX90[ ]	GX90EX

### GX20 System Configuration (up to 450 channels)

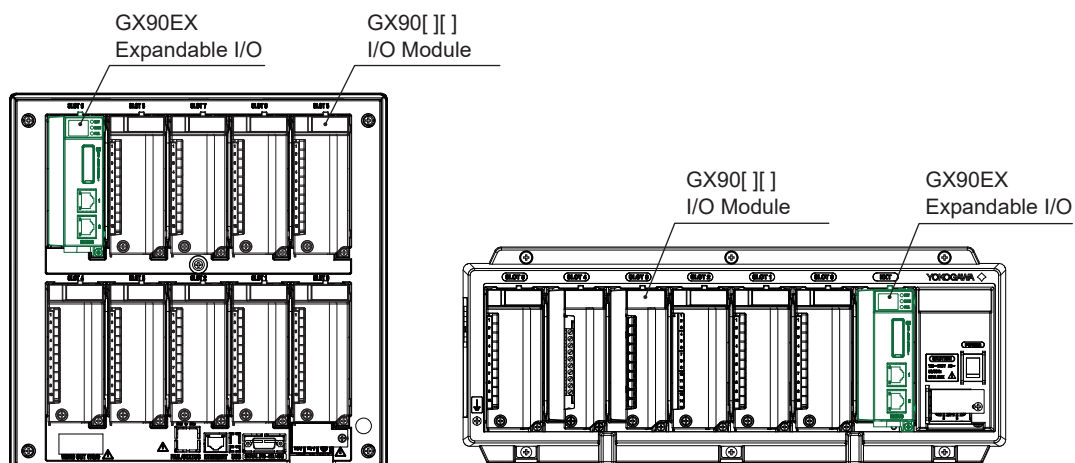

**GX20 Configuration example (maximum)**

- GX20: 1
- GX90: 9
- GX90EX: 1

**GX60 Configuration example (maximum)**

- GX60: 6
- GX90: 36
- GX90EX: 6 (Already installed in the GX60)

GX20  
(Unit 0)

SLOT 9	SLOT 8	SLOT 7	SLOT 6	SLOT 5
GX90EX	GX90	GX90	GX90	GX90
SLOT 4	SLOT 3	SLOT 2	SLOT 1	SLOT 0
GX90	GX90	GX90	GX90	GX90

Expandable I/O  
GX60  
(Unit 1)

SLOT 5	SLOT 4	SLOT 3	SLOT 2	SLOT 1	SLOT 0	EXT
GX90	GX90	GX90	GX90	GX90	GX90	GX90EX

Expandable I/O  
GX60  
(Unit 2)

SLOT 5	SLOT 4	SLOT 3	SLOT 2	SLOT 1	SLOT 0	EXT
GX90	GX90	GX90	GX90	GX90	GX90	GX90EX

Expandable I/O  
GX60  
(Unit 3)

SLOT 5	SLOT 4	SLOT 3	SLOT 2	SLOT 1	SLOT 0	EXT
GX90	GX90	GX90	GX90	GX90	GX90	GX90EX

Expandable I/O  
GX60  
(Unit 4)

SLOT 5	SLOT 4	SLOT 3	SLOT 2	SLOT 1	SLOT 0	EXT
GX90	GX90	GX90	GX90	GX90	GX90	GX90EX

Expandable I/O  
GX60  
(Unit 5)

SLOT 5	SLOT 4	SLOT 3	SLOT 2	SLOT 1	SLOT 0	EXT
GX90	GX90	GX90	GX90	GX90	GX90	GX90EX

Expandable I/O  
GX60  
(Unit 6)

SLOT 5	SLOT 4	SLOT 3	SLOT 2	SLOT 1	SLOT 0	EXT
GX90	GX90	GX90	GX90	GX90	GX90	GX90EX

Blank

# General Specifications

GP10/GP20  
Paperless Recorder  
(Portable type)

**SMARTDAC+**<sup>TM</sup>

GS 04L52B01-01EN

Release R4

## OVERVIEW

The GP10/GP20 are portable type paperless recorders that display real-time measured data on a touch screen and save data on an external storage medium (SD card).

For the input/output module specification, please see GX90XA/GX90XD/GX90YD/GX90WD/GX90XP/GX90YA Input/Output Module and GX90UT PID Control Module General Specification (GS 04L53B01-01EN, GS 04L53B01-31EN.)

- The number of analog input is a maximum of 100 channels in GP10 with expandable I/O<sup>\*1</sup>, GM sub unit<sup>1</sup>, a maximum of 100 channels in GP20 standard type (GP20-1) with expandable I/O, and a maximum of 450 channels<sup>\*2</sup> in GP20 large memory type (GP20-2) with expandable I/O, GM sub unit.  
\*1 A unit for expanding the number of channels.  
\*2 Max. number of input/output channels is 500 channels.
- The GP10/GP20 have the large internal memory (GP10/GP20-1: 500MB, GP20-2: 1.2 GB), and prolonged record and preservation are possible.
- As the input signal, a DC voltage, thermocouple, resistance temperature detector, DI (DCV input (TTL), contact signal), or mA (DC current) can be set to each channel.
- Analog output is capable of retransmission output of various types of channels and also manual output. It provides current output with channels that are isolated. (Analog output module)
- Input and output have module structure and it can extend them easily. (GP10: max. 3\*, GP20: max. 10\*)  
\* In case of using expandable I/O, GM sub unit, GX10 can extend two units, GX20 can extend 9 units.
- A module type is seven types, an analog input, a analog output, a digital input, a digital output, a digital input/output, a pulse input, and a PID control.
- Up to 6 units of expandable I/O units and GM sub units can be connected to the GP10/GP20. Each expandable I/O and GM sub unit can incorporate a maximum of six modules. With expandable I/O, GM sub unit connected, GP10 and the large memory type GP20 can use multiple channels. Furthermore, the I/O ports can be installed in separate locations from where GP10/GP20 is located, helping you reduce wiring requirements and build a decentralized configuration.
- The intuitive operation by flick, pinch in, and pinch out are possible.
- The past trend under recording can be seamlessly displayed on a trend screen.
- Predicts\* the future from past data and draws future waveforms simultaneously with real-time data on the trend screen. (Future pen function)

\* Future waveforms predicted by the Future Pen function are for reference only. Performance, accuracy, and other properties are not guaranteed.

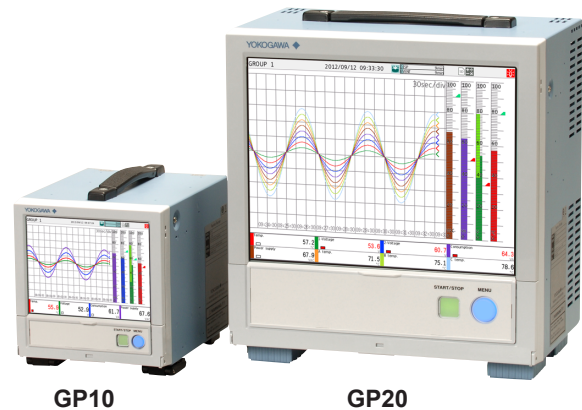

- Moreover, the measurement data of the time specified on the calendar screen can be searched and displayed.
- Various functions, such as a freehand message, a PDF/Excel output of a report file, a direct output to a network printer, a scale movement of a trend display, and a buzzer, are equipped.
- It can be hooked up to network via Ethernet, which enables to inform by Email and to monitor on Web site as well as to transfer files by using FTP. Also, it can communicate with Modbus/RTU or Modbus/TCP.
- Safe measurement up to withstand voltage of 600 V between input terminal and ground is possible by using a high withstand voltage analog input module.
- In high-speed measurement, measurement at the shortest interval of 1 ms is possible by using a highspeed analog input module (high-speed AI).
- In dual interval measurement, measurement can be performed by setting two different scan intervals.
- The PID control function enables PID control on up to 20 loops (6 loops for the GP10/GP20-1) by installing a PID control module.
- The program control function enables program control of up to 99 patterns by using a PID control module and program control function (/PG option). Up to 32 time events and 32 PV events can be set for each segment.

\* For PID control module, PID control Function, and program control function (/PG), see the GX90UT PID Control Module General Specifications (GS 04L53B01-31EN)

\* The contents of this general specifications correspond to the GP10/GP20 with release number 4 and style number 2.  
Release number: firmware ID number  
Style number: hardware ID number

- Various types of computation are possible with the math function (/MT option). The report function enables creation of hourly, daily, and monthly reports and other types of data. Logic math outputs results of computation as 0s or 1s to internal switches and DO channels.
- A setup of GP can be performed on-line from the web browser on PC. A setup by off-line is also possible.
- Universal Viewer software allows a PC to display waveforms on its screen and to print out waveforms.
- The measuring accuracies noted in the general specifications have a margin of error that takes into account the product's components and the equipment used for adjustment and testing. However, the actual values calculated from the accuracy testing data upon shipment of the instrument from the factory are as follows.

Input type		Measuring accuracy <sup>*1</sup> (typical value <sup>*2</sup> )
DCV	20 mV	± (0.01 % of rdg + 5 μV)
	60 mV	± (0.01 % of rdg + 5 μV)
	6 V (1-5 V)	± (0.01 % of rdg + 2 mV)
TC <sup>-3</sup>	R, S	± 1.1 °C
	B	± 1.5 °C
	K (-200.0 to 1370.0 °C)	± (0.01 % of rdg + 0.2 °C) for 0.0 to 1370.0 °C; ± (0.15 % of rdg + 0.2 °C) for -200.0 to 0.0 °C
	K (-200.0 to 500.0 °C)	± 0.2 °C for 0.0 to 500.0 °C; ± (0.15 % of rdg + 0.2 °C) for -200.0 to 0.0 °C
	J	± 0.2 °C for 0.0 to 1100.0 °C; ± (0.10 % of rdg + 0.2 °C) for -200.0 to 0.0 °C
	T	± 0.2 °C for 0.0 to 400.0 °C; ± (0.10 % of rdg + 0.2 °C) for -200.0 to 0.0 °C
	N	± (0.01 % of rdg + 0.2 °C) for 0.0 to 1300.0 °C; ± (0.22 % of rdg + 0.2 °C) for -200.0 to 0.0 °C
RTD	Pt100 (-200.0 to 850.0 °C)	± (0.02 % of rdg + 0.2 °C)
	Pt100 (high resolution) (-150.0 to 150.0 °C)	± (0.02 % of rdg + 0.16 °C)

\*1 Applies to GX90XA-10-U2, A/D integration time 16.67ms or more, General operating conditions: 23±2 °C, 55±10% RH, supply voltage 90–132, 180–264 VAC, supply frequency within 50/60 Hz ±1%, warm-up of 30 minutes or more, no vibrations or other hindrances to performance.

\*2 For the measuring accuracy (guaranteed), see the module's general specifications (GS04L53B01-01EN).

\*3 These values do not include the reference junction compensation accuracy.  
rdg: reading value

## ■ MAIN UNIT SPECIFICATIONS

### ■ FUNCTIONAL SPECIFICATION

#### Input/Output Specifications

Please see GX90XA/GX90XD/GX90YD/GX90WD/GX90XP/GX90YA I/O Module and GX90UT PID Control Module General Specifications.

Model	Name	General Specification No.
GX90XA	Analog input module	GS 04L53B01-01EN
GX90DX	Digital input module	
GX90YD	Digital output module	
GX90WD	Digital input/output module	
GX90XP	Pulse input module	
GX90YA	Analog output module	GS 04L53B01-31EN
GX90UT	PID control module	

#### Measuring Functions

- The number of installable modules and I/O channels (total for GP, expandable I/O and GM sub unit)

##### GP10/GP20-1

Item	GP10/GP20-1
Number of module	Max. 10
Number of input/output module	Max. 100

##### GP20-2

Item	GP20-2
Number of module	Max. 45
Number of input/output module	Max. 500 (or max. 450 for AI only)

Module installation limitations:

See "Limitations" and "Notes on Module Installation."

- Expandable I/O, GM sub unit connection  
Number of connectable units: Up to 6 units total  
\* Connection is not possible if the measurement mode is set to High speed.  
For details on expandable I/O units and GM sub units, see the respective General Specifications (GS 04L53B00-01EN, GS 04L55B01-01EN).

**Scan interval:**

1, 2, 5, 10, 20, 50, 100, 200, 500 ms, 1, 2, 5 s  
 Note) Some intervals will be unavailable depending on the system configuration and modules.  
 For details, see the I/O Module General Specifications (GS 04L53B01-01EN) and "Limitations" in this manual.

**Measurement mode:**

- Normal  
 A mode in which the shortest measurement interval is 100 ms  
 Number of measurement groups: 1  
 File type: Display data, event data  
 Data format: Binary or text  
 Scan interval: 100 ms (fastest)  
 Compatible modules: All modules
- High speed  
 A mode in which high-speed measurement is possible at the shortest measurement interval of 1 ms  
 Number of measurement groups: 1  
 File type: Event data only  
 Data format: Binary only  
 Scan interval: 1 ms (fastest)  
 Compatible modules: High-speed AI (GX90XA-04-H0), DI (GX90XD), DIO (GX90WD)  
 However, one module, either DI or DIO, can be installed. DI input is fixed to remote mode. Measurement and recording are not possible.
- Dual interval  
 A mode in which measurement is possible by setting different scan intervals on the two measurement groups.  
 Number of measurement groups: 2  
 File type: Event data only  
 Data format: Binary only  
 Scan interval:

Model	measurement group 1	measurement group 2
GP10/GP20-1	5 ms (fastest)	100 ms (fastest)
GP20-2	1 ms (fastest)	100 ms (fastest)

Compatible modules: All modules except PID control module

- \* Depending on the measurement mode, there is a limit to the number of measurement channels and recording channels at scan intervals shorter than 100 ms. See "Limitations."

**Display Functions****Display groups:**

Number of groups; GP10: 30, GP20-1: 50, GP20-2: 60  
 Number of channels that can be assigned to each group; GP10: 10, GP20: 20

**Display color (Trend/Bar graph/Digital display):**

Channel: Select from 24 colors  
 A desired display color can be selected freely using its RGB value.  
 Background: Select from white or black

**Display type:**

- Trend display (T-Y)  
 Display method:  
 Direction: Horizontal, vertical  
 Trend interval(Recording interval): 50 ms/div (1 ms), 100 ms/div (2 ms), 250 ms/div (5 ms), 500 ms/div (10 ms), 1 s/div (20 ms), 2.5 s/div (50 ms), 5 s/div (100 ms), 10 s/div (200 ms), 15 s/div (500 ms), 30 s/div (1 s), 1 min/div (2 s), 2 min/div (4 s), 5 min/div (10 s), 10 min/div (20 s), 15 min/div (30 s), 20 min/div (40 s), 30 min/div (1 min), 1 h/div (2 min), 2 h/div (4 min), 4 h/div (8 min), 10 h/div (20 min)
  - Trend interval shorter than 30 s/div (1 s) cannot be set on electromagnetic relay type analog input modules.
  - Trend interval shorter than 15 s/div (500 ms) cannot be set on low withstand voltage relay type analog input modules.
  - Scan interval shorter than 5 s/div (100 ms) can be specified when the measurement mode is set to High speed or Dual interval.
  - On the GP10/GP20-1, scan interval shorter than 250 ms/div cannot be specified in dual interval mode.
- Trend line width: Thick, normal, thin  
 Scale; GP10: Max. 6, GP20: Max. 10  
 Current value bar graph, color scale band, and alarm point marks can be displayed on the scale.  
 A bitmap image scale can be attached.  
 Moving scale; Scale can be moved on any waveform.
- Others; Grid (Auto, 4 to 12), Trip line, Message, Zone display, Partial expanded display
- Historical trend display (T-Y display)  
 Redisplays the display data or event data in the internal memory or external storage medium  
 Time axis operation: The time axis can be reduced or expanded.  
 Data search: Waveforms from the internal memory can be displayed through the specification of a date and time, calendar, each summary  
 All historical trends can be displayed in one screen.
  - Bar graph display  
 Direction: Vertical or horizontal  
 Scale: Display a scale for each channel  
 Color scale band, and alarm point marks can be displayed on the scale.
  - Digital display  
 Displays measured values numerically  
 A DI input state can be displayed as an arbitrary character string (0=Off/1=On, etc.)  
 Update rate: 0.5 s



- **Overview display**  
Display format: All channels, each groups  
Displays the measured values of all channels and the alarm statuses  
Display in groups only when the maximum number of channels that can be displayed (30 on the GP10, 100 on the GP20) is exceeded.
- **Alarm summary display**  
Displays a log of up to 1000 alarms  
Specify an alarm with the cursor and jump to the corresponding section on the historical trend display.
- **Future alarm summary display**  
Displays a list of alarms currently detected by the future alarm function (the history of future alarms is not stored)
- **Message summary display**  
Time and content of up to 500 messages (simultaneous writing: 450, additional writing: 50)  
Specify a message with the cursor and jump to the corresponding section on the historical trend display.
- **Memory summary display**  
Displays the information (up to 500 (GP10/GP20-1) or up to 1000 (GP20-2) of the data in the memory  
Specify a file with the cursor and jump to the corresponding section on the historical trend display.
- **Report display**  
Displays the report data residing in the internal memory  
For more details, see "MATHEMATICAL FUNCTIONS WITH REPORT FUNCTION (/MT)."
- **Log display**  
Displays the event log, error log, communication log, FTP log, Web log, e-mail log, SNTP log, DHCP log, Modbus log and SLMP log.
- **Multi-panel display (Only for GP20)**  
Divides the screen into two to six sections and displays some different display formats.
- **Internal switch/relay state display**  
Displays the internal switch and ON/OFF state of DO  
Operates the internal switch and ON/OFF state
- **Control screen display (when a PID control module is installed)**  
Control group, control overview, tuning, control summary, control alarm summary, program operation,\* program selection\*  
\* Only when the /PG option is installed
- **Other displays**  
Network information display  
System information display  
System configuration display

**Auto scroll:**

The displayed groups can be automatically switched at a specified interval.  
The display switches in ascending group order.

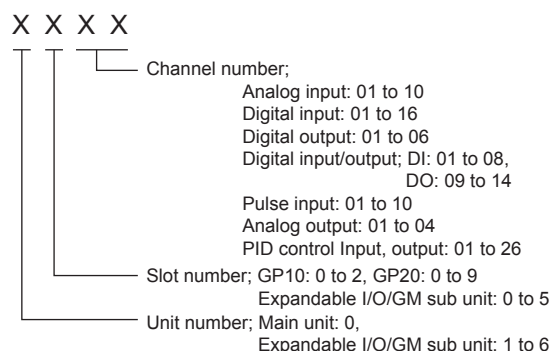
**Names of channels:****Tags:**

- Tag and Tag numbers can be displayed.
- Tag number; Number of characters: Up to 16  
Displayable characters: Alphanumeric characters  
Tag numbers can be enabled or disabled.
- Tag; Number of characters: Up to 32  
Displayable characters: Alphanumeric characters

**Message:**

- Write messages to the trend display.
- Number of messages: 100
- Number of characters: Up to 32
- Write method: Write a preset message or write an arbitrary message on the spot.
- Write destination: Select only the displayed group or all groups.
- Auto message: Write a message when the GP recovers from a power failure while memory sampling is in progress.  
Write a message when the trend interval is switched during memory sampling.

**Add message:**

- Write messages to the past data positions.
- Message: The same as the "Message" item above  
Number of writable messages per file: 50 messages (including 10 freehand messages)

**Freehand message:**

- Can be written by dedicated pen.  
Number of writable messages per file: 50 messages (including 10 Add messages)

**Data Saving Functions****Internal memory:**

- Temporarily saves various types of data.
- Medium: Flash memory
- File storage capacity;  
GP10, GP20-1: 500 MB  
GP20-2: 1.2 GB

**External storage medium:**

- Medium SD card (SD/SDHC) (up to 32 GB)
- Format: FAT32 or FAT16

**Data type:**

- Display data, Event data, Alarm summary data, Manual sampled data, Screen image data, Setup data, and Report data



**Display data:**

- Target: Measurement (input/output module)/ math/communication channels, alarm summary, message summary  
Description: Maximum or minimum value per recording interval
- Recording intervals: Determined by the trend interval, recording data type (display data/display data + event data, GP20-2)
- Number of channels that can be recorded  
For GP20-1

Trend interval (div)	Number of channels
5 s	100
10 s	200
15 s or longer	500

For GP20-2

Trend interval (div)	Number of channels	
	Display data	Display data + Event data
5 s	200	100
10 s	500	200
15 s	1000	500
30 s or longer	1000	1000

Note that the maximum number of channels is fixed at 100 in the GP10.

- Data size;  
Analog input data: 12 bytes/ch.  
Analog output data: 12 bytes/ch.  
Digital I/O data: 4 bytes/ch.  
Pulse input data: 12 bytes/ch.  
Math channel data: 12 bytes/ch.  
Communication channel data: 12 bytes/ch.
- File size: Up to 18 MB
- Number of files for GP10, GP20-1: Up to 500 (including event data), for GP20-2; Up to 1000 (including event data)  
Operation in the internal memory: FIFO (First In First Out)
- Data format: Binary or text
- Recording: Records data at all times.
- Display data file sample time  
Measurement channel = 30. Math Channel = 0

Internal Memory	500 MB
Trend interval (minute/div)	30 minutes
Recording interval (s)	60 s
Total sample time	Approx. 2.5 years

**Event data:**

- Target: Measurement (input/output module)/ math/communication channels, alarm summary, message summary, operation log  
Description: Instantaneous value per recording interval
- Recording intervals: Determined by the scan interval, recording data type (display data/display data + event data)
- Number of channels that can be recorded:  
Measurement mode: Normal

For GP20-1

Recording interval	Number of channels <sup>*1</sup>
100 ms	100
200 ms	200
500 ms or longer	500

For GP20-2

Recording interval	Number of channels <sup>*1</sup>	
	Display data	Display data + Event data
100 ms	500	100
200 ms	500	200
500 ms	1000	500
1 s or longer	1000	1000

Note that the maximum number of channels is 100 in the GP10.

Measurement mode: High speed

Recording interval	Number of channels <sup>*1</sup>		
	GP10	GP20-1	GP20-2
1 ms	2	2	10
2 ms	4	4	20
5 ms	10	10	50
10 ms	20	20	100
20 ms	40	40	150
50 ms	100	100	150
100 ms	100	100	200
200 ms	100	200	500
500 ms	100	500	1000
1 s or longer	100	500	1000

Measurement mode: Dual interval

Recording interval	Number of channels <sup>*1*2</sup>		
	GP10	GP20-1	GP20-2
1 ms	—	—	5
2 ms	—	—	10
5 ms	5	5	25
10 ms	10	10	40
20 ms	20	20	50
50 ms	50	50	50
100 ms	100	100	100
200 ms	100	100	200
500 ms	100	250	600
1 s or longer	100	250	600

\*1 Total number including I/O channels, math channels, and communication channels

\*2 Number of channels that can be recorded is the same for scan group 1 and scan group 2.

- Data size;  
Analog input data: 6 bytes/ch.  
Analog output data: 6 bytes/ch.  
Digital I/O data: 2 bytes/ch.  
Pulse input data: 6 bytes/ch.  
Math channel data: 6 bytes/ch.  
Communication channel data: 6 bytes/ch.
- File size: Up to 18 MB
- Number of files for GP10, GP20-1: Up to 500 (including display data), for GP20-2; Up to 1000 (including display data)
- Operation in the internal memory: FIFO (First In First Out)
- Data format: Binary or text
- Mode; Free: Records data at all times.  
Trigger: Starts recording data when a certain event occurs and records for the specified interval.  
Repetition trigger: Repeat Trigger mode
- Event data file sample time  
Measurement channel = 30. Math Channel = 0

Internal Memory	500 MB
Recording period (s)	1 s
Total sample time	Approx. 1 month

#### Manual Sampled Data:

- Item: Instantaneous value at an arbitrary time
- Target: Measurement (input/output module)/ math/communication channels
- Number of recording channels;  
GP10, GP20-1: Max. 50  
GP20-2: Max. 100
- Maximum number of data values that the internal memory can store: 400
- Data format: Text

#### Report Data:

- Item: Report at each scheduled time of report
- Target: Measurement (input/output module)/ math/communication channels
- Maximum number of reports that the internal memory can store: 800
- Data format: Text

#### Snapshot Data:

- Item: Displayed screen image data
- Data format: PNG
- Output destination: External medium or communication output

#### Setup Data:

- Item: GP setup data
- Data format: text
- Output/read destination (for saving/loading): External medium

### Alarm Functions

- Number of alarms: Up to four alarms (level) for each measurement channels
- Alarm type: High limit, low limit, difference high limit, difference low limit, high limit on rate-of-change alarm, low limit on rate-of-change alarm, delay high limit, and delay low limit
- Alarm delay time: 1 s to 24 hours (for each channel)
- Rate-of-change calculation interval of rate-of-change alarms: 1 to 32 times the scan interval (common to all channels)
- Hysteresis: 0.0 to 5.0% of the span (for each

- alarm (level))
- Alarm output: Output to the internal switch, relay Internal switch/relay operation: AND/OR operation selectable
- Display: Displays the status on the respective operation screen and an alarm icon on the status display section when an alarm occurs.  
Display operation: Hold or not hold the display until the alarm acknowledge operation
- Alarm hide function (alarm no logging function) Used for relay and internal switch output and events of event action and not recorded in alarm display or alarm summary (each channel)
  - Alarm information: Displays a log of alarm occurrences on the alarm summary
- Reflash: The duration for which the reflash relays are deactivated can be set to 500 ms, 1 s, or 2 s.
- Individual alarm ACK function: Alarm display and relay output can be cancelled on individual alarms

### Event Action Functions

- Event action: Execute a specified operation when a given event occurs.
- Number of settings: 50  
Events: Remote control input, etc.  
Number of timers: 12  
Number of match time timers: 12  
Action: Specify memory start/stop, alarm ACK, etc.

### Control Event Action Functions

See GX90UT PID Control Module General Specifications (GS 04L53B01-31EN).

### Future Pen Function

This is available when the measurement mode is normal and when the advanced security function (/AS option) and multi-batch function (/BT option) are disabled.

#### Future pen:

For channels registered as targets of the future pen, the waveform of the future part can be drawn on the trend screen.

- Maximum number of channels: 10
- Prediction range: Recording interval x 60 point
- Recording interval: Enabled when 1 s or more Suitable for data with relatively moderate fluctuations.

Not suitable for data that fluctuates rapidly.

#### Future alarm:

For channels registered as targets of the future pen, an alarm can be generated for measured values predicted in the future.

The alarm value of the future alarm uses the existing alarm setting value.

- Target alarm types: High limit, Low limit, Difference high limit\*, Difference low limit\*
  - \* For channels for which delta is set, only the difference high limit and difference low limit are enabled.
- Display: When a future alarm occurs, the status appears<sup>1</sup> on each operation screen and the alarm icon\* appears in the status display area.
  - \* However, normal alarm display has priority.
- Future alarm mail: Alarm emails can be sent when a future alarm occurs/is released.

- Event Action: Set actions can be run when a future alarm occurs/is released.

Note)

- 1 Multi panel screen and custom display cannot display predicted future waveforms.
- 2 Disabled when trend rate switching is ON.
- 3 Disabled when the file type is event and the recording mode is single/repeat.
- 4 If the input type is Log input, Pseudo-log input, or Linear-log input, predicted future waveforms cannot be displayed.
- 5 The web application cannot display predicted future waveforms and future alarms.

### Security Functions

- Operation lock function: Limitations to touch operation, access to the external storage medium, and various operations
- Login function: Only registered users can operate the GP.  
It can be set to each of touch operation and communication access.  
System administrators and Users: 50 (totally)  
Number of Authority of user: 10 level

### Clock Functions

- Clock: With a calendar function
- Accuracy:  $\pm 5$  ppm (0 to 50°C), excluding a delay (of 1 second, maximum) caused each time the power is turned on.
- Time difference between units:  $\pm 2$ ms max. (time difference between a GP and I/O Base Unit (Expandable I/O))
- Time setting: Using touch operation, communication command, event action function, or SNTP client function
- Time adjustment method:  
Limit in which the time is gradually adjusted: Select from the available settings between 5 s and 15 s.  
Whether to change an out-of-limit operation immediately or report it as an error can be selected.  
While memory sampling: Corrects the time by 1 ms for each second.  
While memory is stopped: Immediately change the time.
- DST: The date/time for switching between standard time and DST can be specified.
- Time zone: Sets the time difference from GMT.
- Date format: Select "YYYY/MM/DD", "MM/DD/YYYY", "DD/MM/YYYY" or "DD.MM.YYYY".  
MM expression can be selected from the numeric character or ellipsis. Ex. January: 01 or Jan  
The delimiter can be selected from "/", ".", "-".

### Ethernet Communication Functions

- Electrical specifications: Conforms to IEEE 802.3
- Connection: Ethernet (10BASE-T/100BASE-TX)
- Max. segment length: 100 m
- Max. connecting configuration: Cascade Max. 4 level (10BASE-T), Max. 2 level (100BASE-TX)
- Connector: RJ-45
- Protocols: TCP, UDP, IP, ICMP, ARP, DHCP, HTTP, FTP, SMTP, SNTP, Modbus, and dedicated protocols

- E-mail client: Automatically send e-mail at specified times.

E-mail is sent by events as below.

- Alarm occurring/alarm releasing (Max. 50ch)
- Recover from power failure
- Report data generating
- Storage medium error, FTP client function error
- Specified time period
- Future alarm occurring/alarm releasing
- POP before SMTP and SMTP authentication (PLAIN and CRAM-MD5) is available.
- FTP client: Automatically transfer data files to the FTP server.  
Applicable files: Display data, event data, screen image data, report data, etc.
- FTP Server: Transfer files, delete files, manipulate directories, and output file lists of the GP.  
Number of the simultaneous connection: Max. 4
- Web server: Web application, GP real-time monitoring and setting changes/operations can be performed with the Web browser.  
Number of the simultaneous connection: Max. 4
- SNTP client: Inquires the time to the SNTP server and sets the GP.
- SNTP server: Outputs the GP time.  
Time resolution: 10 ms
- DHCP client: Automatically obtain the network address settings from the DHCP server.
- Modbus client\*: Reads data from another device and writes to the registers.  
Number of connectable sever;  
GP10, GP20-1: Max. 16  
GP20-2: Max. 32  
\*: Required /MC option
- Modbus server: Loads measurement and math channel data  
Loads and writes communication channel data  
Some control commands such as memory start  
Modbus client\* register access limitations  
\*: Required /MC option  
Number of the simultaneous connection: Max. 4
- Setting/Measurement server: Operate, set, and output data of the GP using a dedicated protocol.  
Number of the simultaneous connection: Max. 4

- DARWIN compatible communication server: Supports some DARWIN commands  
Communication with GP is possible using DARWIN communication commands.
  - Output-related commands: Output measurement (IO) channel data, Output calculation channel data, Output relay status, Output the position of the decimal point for the measurement (IO) channel, Output the position of the decimal point for the calculation channel, Output the information on system configuration
  - Setup-related commands: Range, Scale unit, Alarm, Time, Moving average, zone
  - Operation-related commands: Reset alarm, Reset timer, Start MATH calculation, Rebuild system, Initialize, Input communication, Output communication DO, Write message

### Batch Function

- Function: Data management using batch names. Enter text fields and batch comments in the data file.
- Batch name: Added to the file name of the display data and event data.  
Structure: Batch number (up to 32 characters) + lot number (up to 8 digits)  
Use/not use selectable for lot number, on/off selectable for auto increment function.
- Text field: Adds text to the display data and event data.  
There are 24 available text fields.  
Up to 20 title characters and 30 other characters can be entered per field.
- Batch comment: Adds text to the display data and event data.  
3 comments (max. 50 characters) are available.

### Printer Output Function

- Snapshot Data can be printed out with any LAN-connected printer supporting the HP PCL5c language and the port 9100.

### SSL Communication Functions

Communication that sends and receives information encrypted by the SSL (Secure Socket Layer) protocol is possible.

- Server function:  
Supported servers: HTTP server and FTP server (Port number: 443 when encryption is used)  
Private key: Created in GP and saved in the internal memory  
Server certificate: Server certificates created by users can be saved in the internal memory.  
Self-signed certificates can be created in GP.
- Client function:  
Supported clients: FTP client (only Explicit mode is supported) and SMTP client (only STARTTLS is supported)  
Trusted certificate: Trusted certificates (a total of up to 80 KB) can be saved in the internal memory.

### Electronic Signature Function

Electronic signatures can be added to report files created in PDF format using the PDF form creation function. An electronic signature is provided each time a report file is created.

- Certificate for electronic signature: Certificates for electronic signatures created by users can be saved in the internal memory.

### Loop control Function (With PID control module)

See GX90UT PID Control Module General Specifications (GS 04L53B01-31EN).

### Other Functions

- Buzzer: GP makes a buzzer sound at touch screen operation, or when alarm occurs.
- Backlight saver function: Dim or turn off the LCD backlight if there is no key operation for a specified time.
- Favorite display: Register frequently used displays to the Favorite and show them through simple operation.
- The main alarm is indicated using the MENU key LED.  
No alarm: Blue (same condition as power-on)  
Alarm condition: Red.
- User function feature: A button to which the user can assign a desired function is provided. It can be assigned to an event triggered by the event action function.
- Firmware update function: The Web application, the IO module, or the expansion module firmware can be updated by operating GP.

## ■ HARDWARE SPECIFICATIONS (MAIN UNIT)

### Display

#### Display unit\*:

GP10: 5.7-inch TFT color LCD (640 × 480 dots)  
GP20: 12.1-inch TFT color LCD (800 × 600 dots)

\* A small number of missing or steady-on LCD pixels and minor variations in brightness uniformity is a normal display characteristic and not a malfunction.

#### Touch screen:

4 wire resistive touch screen

### Construction

- Material;  
Case: Metal plate  
Bezel and display cover: Polycarbonate
- Color;  
Case: Smoke blue(Munsell 4.1PB6.0/4.5 equivalent)  
Bezel: Light grey (Munsell 5.2PB8.2/1.0 equivalent)
- External dimensions:  
When installing modules  
GP10: 144(W) × 168(H) × 248(D) mm  
GP20: 288(W) × 318(H) × 248(D) mm  
When uninstalling modules  
GP10: 144(W) × 168(H) × 197(D) mm  
GP20: 288(W) × 318(H) × 197(D) mm  
(D: depth from the panel mounting plane)
- Weight:  
GP10: Approx. 1.9 kg, GP20: Approx. 5.4 kg  
(excluding modules)

### Power Supply

[Power supply suffix code: 1]

- Rated supply voltage: 100 to 240 VAC
- Allowable power supply voltage range: 90 to 132, 180 to 264 VAC
- Rated power supply frequency: 50/60 Hz
- Power consumption:

Supply voltage	LCD backlight off	Normal operation	Maximum
100 VAC	GP10: 16 VA GP20: 28 VA	GP10: 20 VA GP20: 34 VA	GP10: 48 VA GP20: 90 VA
240 VAC	GP10: 24 VA GP20: 38 VA	GP10: 30 VA GP20: 45 VA	GP10: 60 VA GP20: 110 VA

\* The following combinations are assumed for LCD backlight off and normal operation.

GP10: 1 AI module, 1 DO module, 1 DI module  
GP20: 5 AI modules, 4 DO modules, 1 DI module

- Module power supply voltage: The total allowable power consumption of respective modules is up to 6 W in the GP10 and up to 20 W in the GP20.
- Allowable interruption time: Less than 1 cycle of the power supply frequency

[Power supply suffix code: 2]

- Rated supply voltage: 12 VDC
- Allowable power supply voltage range: 10 to 20 VDC

- Power consumption:

Supply voltage	LCD backlight off	Normal operation	Maximum
12 V DC	7 VA	10 VA	26 VA

### Isolation

- Insulation resistance: Between the Ethernet, RS-422/485, and each insulation terminals and earth: 20 MΩ or greater at 500 VDC
- Withstand voltage:  
Between the power terminal and earth (In case of Power supply suffix code: 1): 3000 V AC at 50/60 Hz for one minute  
Between the power terminal and earth (In case of Power supply suffix code: 2): 500 V AC at 50/60 Hz for one minute  
Between the contact output terminal and earth: 3000 VAC at 50/60 Hz for one minute  
Between the input/output modules and earth: Depends on the specification of I/O module.
- Grounding: Be sure to set a low grounding resistance.
- Isolation:

Power terminal	FAIL output terminal	Internal circuit
	Ethernet port	
	RS-422/485 terminal	
	Input and output module terminal	
	Input and output module internal circuit	
	Earth (PE) terminal	
	RS-232 terminal	
	SD card slot	
	USB port	

The circuits divided by lines are insulated mutually.

### Safety and EMC Standards

- CSA:  
CAN/CSA-C22.2 No.61010.1,  
CAN/CSA-C22.2 No. 61010-2-030,  
CAN/CSA-IEC 61010-201<sup>4</sup>, Overvoltage Category II or I<sup>1</sup>, Pollution Degree 2<sup>2</sup>, Measurement Category<sup>3</sup>
- UL:  
UL61010-1, UL 61010-2-030, UL61010-2-201<sup>4</sup> (CSA NRTL/C), Overvoltage Category II or I<sup>1</sup>, Pollution Degree 2<sup>2</sup>, Measurement Category<sup>3</sup>
- CE/EMC directive:  
EN61326-1 Class A Table 2 compliant  
EN61000-3-2 compliant  
EN61000-3-3 compliant  
EN55011 Class A Group 1 compliant
- CE/Low voltage directive:  
EN61010-1, EN 61010-2-030, EN61010-2-201<sup>4</sup>, Overvoltage Category II or I<sup>1</sup>, Pollution Degree 2<sup>2</sup>, Measurement Category<sup>3</sup>
- CE/RoHS directive:  
"2011/65/EU+(EU)2015/863" (10-Substances) compliant
- WEEE Directive: Compliant
- EMC Regulatory Arrangement in Australia and New Zealand (RCM): EN55011 Class A Group 1 compliant
- KC marking: KN11, KN61000-6-2 compliant



- \*1 Overvoltage Category:  
Describes a number which defines a transient overvoltage condition.  
Implies the regulation for impulse withstand voltage.  
"II" applies to electrical equipment which is supplied from the fixed installation like a distribution board.  
II: Applied to power supply voltage code 1 (100-240 VAC)  
I: Applied to power supply voltage code 2 (12 VDC)
- \*2 Pollution Degree 2:  
Describes the degree to which a solid, liquid, or gas which deteriorates dielectric strength or surface resistivity is adhering.  
"2" applies to normal indoor atmosphere.  
Normally, only non-conductive pollution occurs.
- \*3 Measurement Category: Depends on the specification of each modules

Category	Measurement category	Description	Remarks
II	CAT II	Available in the testing and measuring circuits directly connected to a usage location (receptacle or the like) of a low-voltage main power supply facility.	Appliances, portable equipment, etc.
III	CAT III	Available in the testing and measuring circuits connected to a power distribution portion of a low-voltage main power supply facility.	Distribution board, circuit breaker, etc.
IV	CAT IV	Available in the testing and measuring circuits connected to a power source of a low-voltage main power supply facility.	verhead wire, cable systems, etc.

- \*4 Support for GX10/GX20 hardware style 2 and later.  
This product is designed as open equipment under the relevant standard, install it as follows:
- To make the GP10/GP20 comply with the relevant standard, support the parts of the device other than the front-panel control area with an instrumentation panel or the like, and install it in a location where people cannot touch the terminals carelessly or in a panel.
  - Install the GX60/GM unit in a panel with a door.
  - The instrumentation panel or panel used for support must comply with CSA/UL/EN 61010-2-201 or must be at least IP1X (degrees of protection) and at least IK09.

### Normal Operating Conditions:

- Power supply voltage: 100 to 240 V AC  $\pm 10\%$
- Power supply frequency: 50/60Hz  $\pm 2\%$
- Ambient temperature: 0 to 50°C
- Ambient humidity: 20 to 80 %RH (However, less than moisture content of 40°C 80% RH at 40°C or more), No condensation
- Magnetic field: 400 A/m or less (DC and 50/60 Hz)
- Vibration:  
5 ≤ f < 8.4 Hz amplitude 3.5 mm (peak)  
8.4 ≤ f ≤ 160 Hz acceleration 9.8 m/s<sup>2</sup>
- Shock:  
Non-energization, 500 m/s<sup>2</sup> or less, approximate 10 ms, 6 directions (±X, ±Y, ±Z), 3 times in each direction
- Mounting position: Can be inclined up to 30 degrees backward. Left and right horizontal when installing the panel mount and wall mount.
- Altitude: 2000 m or less
- Installation location: Indoors
- Warm-up time: At least 30 minutes after power on

### Other Specifications:

- Memory backup: A built-in lithium battery backs up the settings and runs the clock
- Recommended replacement periods of Battery: Approximately 10 years (at room temperature)

### Transport and Storage Conditions:

- Ambient temperature: -25 to 60°C
- Ambient humidity: 5 to 95 %RH (no condensation)
- Vibration: 10 to 60 Hz, 4.9 m/s<sup>2</sup> maximum
- Shock: 392 m/s<sup>2</sup> maximum (in packaged condition)

## EXTERNAL DIMENSIONS AND PANEL CUTOUT DIMENSIONS

### GP10:

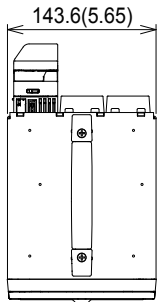

Unit: mm (approx. inch)  
Unless otherwise specified,  
tolerance is  $\pm 3\%$  (however,  
tolerance is  $\pm 0.3$  mm when  
below 10 mm).

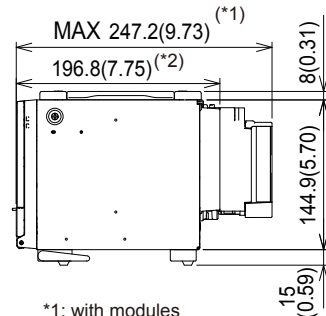
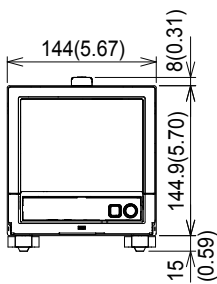

\*1: with modules  
\*2: without modules

When using the stand, GP10 is upward 12 degrees.

### Rear view

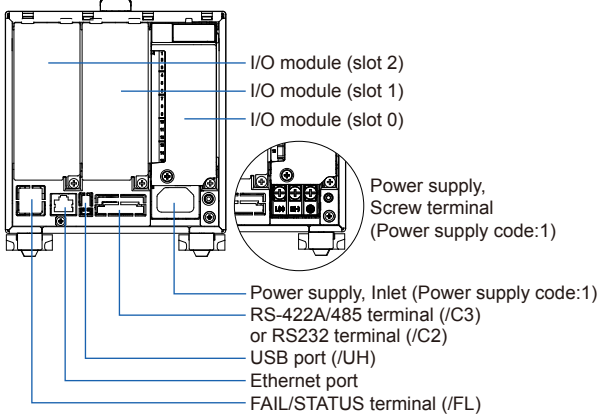

### GP20:

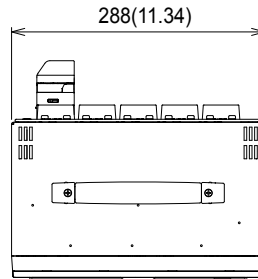

Unit: mm (approx. inch)  
Unless otherwise specified,  
tolerance is  $\pm 3\%$  (however,  
tolerance is  $\pm 0.3$  mm when  
below 10 mm).

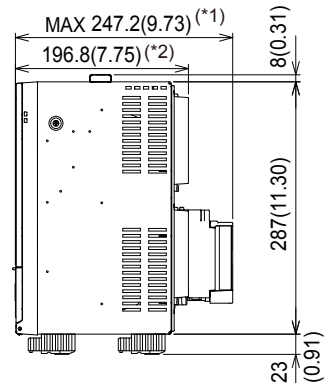
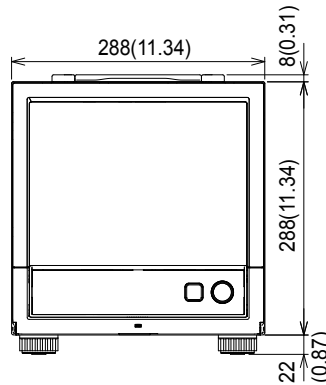

\*1: with modules  
\*2: without modules

### Rear view

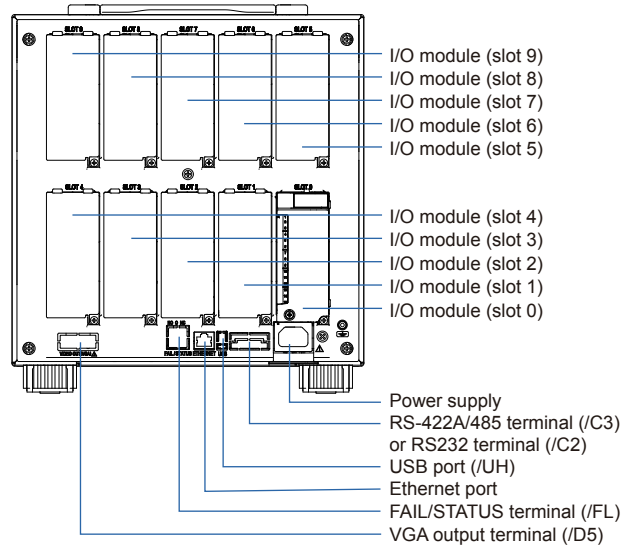

### Precautions to Be Taken While Wiring

With a screw terminal, we recommend that you use a crimp-on lug with an insulation sleeve (M4 for power supply wiring, M3 for signal wiring).

Recommended signal wiring crimp-on lug  
N1.25-MS3 (JST Mfg. Co., Ltd.)

## ■ SPECIFICATIONS OF OPTIONAL FUNCTIONS

### ADVANCED SECURITY FUNCTION (/AS)

Security functions, electronic recording and electronic signature functions, and data integrity functions complying with FDA 21 CFR Part11 will be added.

- Enabling/disabling the advanced security function:  
You can enable or disable the advanced security function.
- \* The set values and data stored in the internal memory are initialized each time the function is enabled or disabled.
- Data anti-tamper function:  
Settings and measured data are saved as encrypted binary files.
- Data type:  
Only for display or event  
Trigger mode is not possible with event data.
- Login function:  
Using the login function described below, you can enter security settings on the instrument
  - User name
  - Password
  - User ID (depend on setting)
  - User level and number of users:  
System administrator (all can be operated), Second administrator (Admin property and user property settings can be used to restrict executable operations and signatures.), General user (With user restrictions, you can set restrictions on performing operations and sign authority.), Monitor user (monitoring only), totally 100 users (GP20-2: 200 users)
  - Admin property setting: 10 kinds (for second administrator)
  - User restrictions setting: 10 kinds (for second administrator, general users)
- Password expiration time:  
select form Off, 1month, 3 month, 6month
- Advance notice of expiry date:  
A message encouraging the user to change the password is displayed when the user logs in during the specified notification period (Off, 5 days before, 10 days before).
- Password policy function:  
The minimum number of characters and the types of characters that must be included can be set.
- Password control function:  
Logins are verified by a Kerberos v5 authentication server\* (only user name and password)  
Encryption method:  
AES128-CTS-HMAC-SHA1-96  
AES256-CTS-HMAC-SHA1-96  
ARCFOUR-HMAC-MD5  
Pre-Auth function: use
  - \* The function has confirmed compatibility with Windows Server 2003 SP2/Windows Server 2008 SP2/Windows Server 2012/Windows Server 2016 ActiveDirectory

- Signature function:  
After checking data that has finished being recorded, you can add three levels of electronic signature, select a pass/fail, and enter comments (50 characters maximum)
- Audit trail function:  
The operation log, the settings change log and the settings file when the change was made are saved.  
Comments that are entered when settings are changed or when an alarm is acknowledged are recorded in the event log. This allows you to check the comments and details of the setting changes.
- Measurement mode limitations  
High speed and Dual interval measurement modes are not supported.
- Module limitations  
PID control modules are not supported.

### SERIAL COMMUNICATION INTERFACE (/C2, /C3)

- Connection: EIA RS-232(/C2) or EIA RS-422/485(/C3)
- Protocol: Dedicated protocol, Modbus/RTU, or DARWIN compatible communication
- Setting/measurement server function: Operation, setting or output of measurement data are available by dedicated protocol.
- Synchronization: Start-stop synchronization
- Transmission mode (RS-422/485):  
RS-422: Four-wire half-duplex multi-drop connection (1:n (n = 1 to 31))  
RS485: Two-wire half-duplex multi-drop connection (1:n (n = 1 to 31))
- Baud rate: 1200, 2400, 4800, 9600, 19200, 38400, 57600, or 115200 bps
- Data length 7 or 8 bits
- Start bit: 1 bit
- Stop bit: 1 bit or 2 bit
- Parity: ODD, EVEN, or NONE
- Handshaking Off: Off, XON: XON, XON: RS, and CS: RS
- Communication distance; RS-422/485: 1200 m (57600 bps or less), 600 m (115200 bps)  
RS-232: 15 m  
Applicable cable: AWG24 to 16
- Modbus/RTU communication: Reading or writing of measurement data on other instruments is available by Modbus protocol.  
Communication channel function option (/MC) is needed to read measurement data from other instruments.
- Operation modes: Master or slave
- Execution of a communication command using a bar code: The entered text can be executed as a communication command.



## CUSTOM DISPLAY (/CG)

Using DXA170 DAQStudio, screen creation software, a custom screen can be constructed and displayed in which display components (such as trend, digital, and bar graphs) are freely placed. The screen data is transferred from DAQStudio to the internal memory via communication, or loaded from an external medium to the internal memory and displayed.

- Number of screens: 30 (internal memory)
- Display components:
  - Normal components (digital value, bar graph, tag No., tag comment, simple digital value, simple bar graph, alarm mark, unit, alarm indicator, lower-limit span value, upper-limit span value, group name, system icon, memory sample bar, date/time view, batch name, and user name)
  - Trend components (trend group display (with scale board))
  - List components (alarm list view and message list view)
  - Operation components (DO (DO operable), internal switch (internal switch operable), numeric value operations (viewing data of and writing data to communication channels), and button operations (writing numeric values, operating bits, switching screens, and executing communication commands))
  - Text components (labels)
  - Figure components (line view, rectangle view, and circle view)
  - Image components (PNG image data)
  - Batch components (Batch number, Lot number, Text field, Batch comment, Batch group number\*)
    - \* Only on GP with the Multi batch function (/BT option)
  - Control component (controller, control alarm indicator, external controller)
- Configuring screens: Screen creation software Creation using DXA170 DAQStudio (GP does not have a creation function)
- Saving/loading screen data: A specified screen or all the screens is/are loaded from an external storage medium to the internal memory, or a specified screen or all the screens in the internal memory is/are saved on an external storage medium.

## VGA VIDEO OUTPUT (/D5) (Only for GP20)

- External display:  
Resolution: 800 × 600 dots (VGA)  
Connector: 15-pin D-Sub (female)

## EtherNet/IP COMMUNICATION (PLC communication protocol) (/E1)

Can be joined to an Ethernet/IP network as an adapter (or a server).

- Loading data from the I/O channel or calculation channel (/MT), alarm status

Note: Control alarm status cannot be loaded.

I/O channel:

GP10: 100, GP20-1: 100, GP20-2: 500

Calculation channel:

GP10: 50, GP20-1: 100, GP20-2: 200

- Loading and writing data from/to the communication channel (/MC)  
Loading from the alarm status  
Communication channel:  
GP10: 50, GP20-1: 300, GP20-2: 500
- Implementation level: Level 2
- Operations that can be performed using explicit messages:  
Communication is performed using the CIP extension feature of the PLC-specific PCCC command by Rockwell Automation.  
Start and stop recording and computation  
Write batch information  
Write messages  
Load alarm status  
Write alarm setpoints and alarm types  
Alarm ACK  
Note: The following operations are not possible: load control alarm status, write control alarm setpoints and control alarm types, control alarm ACK.
- Supported protocols: EIP/PCCC, EIP/native
- Number of the simultaneous connection: Max. 10 (Explicit message)

## WT COMMUNICATION (/E2)

Collects data by connecting to WT equipment manufactured by Yokogawa Meters & Instruments Corp. via Ethernet communication\*.

\* The /MC option is required.

- Supported models: WT1800E (command type WT1800), WT1800, WT300E (command mode WT300), WT500, and WT300
- Number of connectable units:  
GP10: 8  
GP20: 16
- Communication cycle: 500 ms/1 s/2 s/5 s/10 s/20 s/30 s
- Types of data that can be obtained: Voltage, current, power, power factor, phase, electrical energy, high-frequency wave, etc.
- Number of data allocations  
GP20: 300  
GP10: 50

## FAIL OUTPUT (/FL)

- Contact: C contact, 1 point
- FAIL output:  
The relay contact output on the rear panel indicates the occurrence of CPU failure.  
Relay operation: Energized during normal operation and de-energized on CPU failure.
- Status output: The relay contact, which is de-energized in normal output state, is energized upon the occurrence of a memory/media error, measurement error, communication error, recording stop, or alarm.

- Rated power supply voltage: 24 V DC or 250 V AC or less
- Rated load current: 3A (DC)/3A (AC), resistance load
- Min. load current: 100 mA
- Recommended replacement periods of contact:  
Electrical: 30,000 more ON-OFF operations,  
Mechanical: 5,000,000 more ON-OFF operations

### Log SCALE (/LG)

A logarithmic voltage that has been converted from a physical value is applied to the GP, and then the GP's Log scale (logarithmic scale) is used to display and record the physical value.

- Input type: Log input (logarithmic input), Pseudo log input: An input that supports pseudo logs, Log linear input: Input that is linear on a logarithmic scale.
- Range: 20mV/60mV/200mV/1V/2V/6V/20V/50V/100V
- Scalable range:
  - Log input:  
1.00E-15 to 1.00E+15 (15decade maximum)  
Scale\_L < Scale\_U  
If the lower limit mantissa is 1.00, the difference between the exponents must be 1 or more.  
If the lower limit mantissa is a value other than 1.00, the difference between the exponents must be 2 or more.
  - Pseudo Log Input/Log linear input  
1.00E-15 to 1.00E+15 (15decade maximum)  
The higher limit mantissa is the same as the lower limit mantissa).  
If the lower limit mantissa is 1.00, the value must be between 1.00E-15 and 1.00E+15, the difference between the exponents must be 1 or more, and the maximum decades is 15.  
If the lower limit mantissa is a value other than 1.00, the value must be between 1.01E-15 and 9.99E+14, the difference between the exponents must be 1 or more and the maximum decades is 15.
- Alarm type: High limit, low limit, delay high limit, and delay low limit
- Alarm setting range: The range converted into the LOG scale corresponding to -5% to 105% of the span width.
- Alarm hysteresis: Fixed to 0
- Green band setting range: The lower limit to the upper limit of the scale. However, the lower limit of the display position must be smaller than the upper limit.
- Position of the decimal point: 1 to 2
- Misc: Nonlinear input is possible by correcting the input value

### MATHEMATICAL FUNCTIONS WITH REPORT FUNCTION (/MT)

#### Mathematical Function:

- Number of math channels; GP10: 50, GP20-1: 100, GP20-2: 200

Note) Note: Depending on the measurement mode, there is a limit to the number of math channels at scan intervals shorter than 100 ms. See "Limitations."

- Scan interval

Measurement mode	Scan interval
Normal	Scan interval
High speed	Scan interval
Dual interval	Master scan interval*

- \* When the measurement mode is Dual interval, this item sets which scan interval to use, the interval of measurement group 1 or that of scan group 2, for creating measured values of math or communication channels and other similar operations.
- Number of expressions:
- Operation:  
General arithmetic operations: Four arithmetic operations (+, -, \*, /), square root, absolute, common logarithm, natural logarithm, exponential, and power  
Relational operations: <, ≤, >, ≥, =, and ≠  
Logic operations: AND, OR, NOT, and XOR  
Statistical operations: TLOG (maximum, minimum, average, sum, P-P values of time series data) or CLOG (maximum, minimum, average, sum, P-P values of a specified channel)  
Special operations: PRE, HOLD, RESET, and CARRY  
Conditional operation: [a?b:c]  
Bit operation: BIT  
Integer extracting operation: INT  
Remainder extracting operation: MOD  
Trigonometric functions: SIN, COS  
CP operations: CP.02, CP.CO2
- Computation accuracy: Double-precision floating point
- Data that can be used;  
Channel data: Measurement channels (0001 to 6516 to 6516), mathematical channels (GP10: A001 to A050, GP20-1: A001 to A100, GP20-2: A001 to A200), Communication channels (GP10: C001 to C050, GP20-1: C001 to C300, GP20-2: C001 to C500), Communication channels raw data (GP10: RC001 to RC050, GP20-1: C001 to C300, GP20-2: RC001 to RC500), Constants: K001 to K100, Variable constant: W001 to W100, Internal switch: S001 to S100, Flag: F01 to F20, Recording state (REC01), Integer data: Z000 to Z999

**Logic math function:**

A function that outputs calculated results as 0 or 1 to DOs or internal switches

- Number of logic calculations maths:  
GP10: 20, GP20-1/GP20-2: 50
- Expression: Up to 120 characters
- Computation type: Basic arithmetic, relational, logical, conditional, bit
- Data that can be used: All channel data
- Logic math: LM001 to LM020 (GP10), LM001 to LM050 (GP20-1/GP20-2)
- Output destination: DO channels, internal switches (only when set to Manual in either case)
- Setting change: Cannot be changed during recording
- Math interval: 100 ms (fastest)

**Report function:**

- Number of report channels; GP10: 50, GP20: 60
- Note) Depending on the measurement mode, there is a limit to the number of report channels at scan intervals shorter than 100 ms. See "Limitations."
- Scan interval

Measurement mode	Scan interval
Normal	Scan interval
High speed	Scan interval
Dual interval	Scan interval of each measurement group

- Report types: Hourly + daily, daily + weekly, daily + monthly, Batch, Day custom
- Computation types: Average, maximum, minimum, sum, or instantaneous value
- Unit of sum: OFF, /s, /min, /hour, /day
- Report templates: Office Open XML spreadsheet files (which can be displayed with Microsoft Office Excel) or PDF files can be output or printed out with any LAN-connected printer supporting the HP PCL5c language and the port 9100.

**COMMUNICATION CHANNEL FUNCTIONS (/MC)**

- Number of communication channels;  
GP10: 50 (C001 to C050)  
GP20-1: 300 (C001 to C300)  
GP20-2: 500 (C001 to C500)
- Note) Depending on the measurement mode, there is a limit to the number of communication channels at scan intervals shorter than 100 ms. See "Limitations."  
The minimum communication channel update interval is 100 ms.
- Scan interval

Measurement mode	Scan interval
Normal	Scan interval
High speed	Scan interval
Dual interval	Master scan interval

- \* Required to record data from EtherNet/IP (/E1), Modbus devices, or PCs on the GP and to write data in the remote device from the GP via Modbus.
- Calibration correction  
Mode: Linearizer Approximation, Linearizer Bias, Correction factor\*  
Number of set points: 2 to 12
- \* Only when the /AH option is installed

**USB INTERFACE (/UH)**

- USB port: Complies with USB 2.0 and host function
  - Number of ports: 2 (one each on the front panel and rear panel)
  - Connectable devices: Only connect the devices listed below to prevent damage to the devices.
    - Keyboard: Complies with HID Class Ver. 1.1 104/89 keyboard (US) and 109/89 keyboard (Japanese)
    - Mouse: Complies with HID Class Ver. 1.1
    - External medium: USB flash memory FAT16 or FAT32 format with a 32 KB or smaller cluster size.  
Does not guarantee the operation of all USB flash memories  
External medium such as a hard disk, ZIP, MO, and optical discs are not supported.
    - Barcode reader: USB HID Class Ver. 1.1 compatible  
English (U.S.) standard USB keyboard compatible
  - Execution of a communication command using a bar code: The entered text can be executed as a communication command.
  - Power supply: 5 V  $\pm$ 10%, 500 mA \*1
- \*1: Devices which need more than 500 mA total bus power for 2 ports cannot be connected at the same time.  
For low powered devices (bus power < 100 mA):  
5V  $\pm$  5%  
For high powered devices (bus power < 500 mA):  
5V  $\pm$  10%

**AEROSPACE HEAT TREATMENT (/AH)**

- Supports heat treatment application AMS2750/NADCAP.
- Schedule management for periodically executing calibration correction configuration and the like.  
In correction coefficient mode of calibration correction, two biases can be specified: one based on thermocouple and another based on device
- Number of manageable schedules  
GP20-1:6  
GP20-2: 12
- Calibration correction mode:  
Off, Linearizer approximation, Linearizer bias, correction factor
- Number of set points: 2 to 12
- Notification contents  
Title, Notification message, Due date  
Notification buzzer can be sounded.

## MULTI-BATCH FUNCTION (/BT)

Recording start/stop and data file creation is possible for each batch.

- Number of multi-batches:  
GP10/GP20-1: max. 6, GP20-2: max. 12
- Batch single operation: Memory start/stop, math reset, message writing
- Batch overview operation: Computation start/stop, report start/stop, manual sampling, setup data save/load
- Scan interval: 500ms, 1 s, 2 s, 5 s (common to all batches)
- Data type: Display or event only Trigger mode not available for event data.
- Recording interval: Common to all batches
- Data file: Display or event data file created for each batch
- Number of display groups:  
GP10: 6 max. per batch  
Number of channels per group: 10  
GP20-1: 6 max. per batch  
Number of channels per group: 20  
GP20-2: 12 max. per batch  
Number of channels per group: 20  
Channels assigned to the display group of each batch and those set as recording channels are recorded to data files.
- Batch single settings: Group, trip line, file header, data file name, text field, batch number, lot number
- Measurement mode limitations  
High speed and Dual interval measurement modes are not supported.

## OPC-UA SERVER (/E3)

Data acquired by the GP can be accessed through Ethernet communication from a host system (OPC-UA client).

- Communication  
Mode: OPC-UA Server  
Encoding: UA Binary  
Protocol: OPC UA TCP  
Maximum number of connections: 3 sessions  
Profile Micro Embedded Device Server
- Security  
Type: None  
Encryption: None  
Login: Anonymous, Username
- Data acquisition:  
Measurement value, alarm status, and alarm value  
Computation value, alarm status, and alarm value  
Communication value, alarm status, and alarm value  
Batch information  
PV, SP, OUT, R/S, A/M/C, R/L, Alarm status in loop
- Data writing: Measurement channel (DO channel only), communication channel, alarm value, batch information, OUT, R/S, A/M/C, R/L
- Other acquired information: Device name, serial number, time, device status
- Port number: 4840 (changeable: 1 to 65535)
- Number of items:  
GP10: 100 max. (MonitoredItem/Session)  
GP20: 300 max. (MonitoredItem/Session)

- Fastest period:100ms
- Service set:

Discovery	FindServers, GetEndpoints
SecureChannel	OpenSecureChannel, CloseSecureChannel
Session	CreateSession, ActivateSession, CloseSession
View	Browse, BrowseNext, TranslateBrowsePathsToNodeIds
Attribute	Read, Write
MonitoredItem	CreateMonitoredItems, ModifyMonitoredItems, DeleteMonitoredItems, SetMonitoringMode
Subscription	CreateSubscription, ModifySubscription, DeleteSubscriptions, Publish, Republish, SetPublishingMode

## SLMP COMMUNICATION (Mitsubishi PLC) (/E4)

CC-Link family SLMP communication protocol function, which enables connection from a GP to Mitsubishi Electric PLCs without sequencer programs.

The GP operates as an SLMP client. Writing GP measurement data to a PLC and reading PLC data into communication channels\* are possible.

\* The communication channel function (/MC option) is required.

- Number of connection destination servers: 16 max.
- Read cycle: 100ms/200ms/500ms/1s/2s/5s/10s/20s/30s/1min
- Number of commands that can be registered  
GP10: 50  
GP20-1: 100  
GP20-2: 200
- Communicable internal data:  
Special relay (SM), special register (SD), input (X), output (Y), internal relay (M), latch relay (L), annunciator (F), edge relay (V), link relay (B), data register (D), link register (W), timer contact (TS), timer coil (TC), current timer value (TN), integration timer contact (SS), integration timer coil (SC), current integration timer value (SN), counter contact (CS), counter coil (CC), current counter value (CN), special link relay (SB), special link register (SW), direct access input (DX), direct access output (DY), index register (Z), file register (R, ZR), extended data register (D), extended link register (W)

Device code is indicated in parentheses.

## Program control function (/PG)

See GX90UT PID Control Module General Specifications (GS 04L53B01-31EN)

## ■ Limitations

### System limitations

#### Maximum number of channels

System	Measurement mode	Maximum number of module connections	Maximum number of channels			
			Input/output	Communication	Math	Report
GP10	Normal	10	100	50	50	50
	High speed	3	12	50	50	50
	Dual interval	10	50	25	25	25
GP20-1	Normal	10	100	300	100	60
	High speed	10	40	300	100	60
	Dual interval	10	50	150	50	30
GP20-2	Normal	45	500	500	200	60
	High speed	10	40	500	200	60
	Dual interval	45	250	250	100	30

#### Limit to the number of expandable I/O units or GM sub units

- Up to six units can be connected.
- Connection is not possible if the measurement mode is set to High speed.

#### Limit to the number of GP main unit modules

Module	GP10	GP20-1	GP20-2
When GX90XA-04-H0 and GX90YA are included	2*	9	9
When GX90UT is included	2*	8	8

\* When the 12 V DC (Power supply Suffix Code 2) model.

#### Limit on Modules

- Up to 10 modules consisting of GX90YD, GX90WD, and GX90UT can be installed into the system.
- One GX90WD module can be installed in a GP. One module can be installed in a GX60 (expandable I/O) and each GM sub unit.
- One GX90YA module can be installed in a GP10. Two modules can be installed in each of the GP20, GX60 (expandable I/O) and GM sub unit.
- Up to 10 GX90YA modules can be installed in a GP10/GP20-1 system and up to 12 in a GP20-2 system.
- If the measurement mode is High speed, a GX90XD or GX90WD module can be installed in the system.
- If the measurement mode is High speed, only GX90XA-04-H0 (high-speed AI), GX90XD (DI), and GX90WD (DIO) are detected. DI and DIO are fixed to remote mode. Measurement and recording are not possible.
- If the measurement mode is Dual interval, GX90UT is not detected.

#### Limit to the Number of Measurement Channels

The following limitation applies to the number of channels that can measure at scan intervals shorter than 100 ms. If the measurement mode is Dual interval, the limitation applies at the scan group level. However, there are scan intervals you cannot set.

- **Measurement mode is High speed**

##### GP10

Channel	Scan interval					
	1 ms	2 ms	5 ms	10 ms	20 ms	50 ms
Input/output	1	2	5	10	12	12
math	–	1	2	5	10	25
communication	–	1	2	5	10	25
Report	–	1	2	5	10	25

**GP20-1**

Channel	Scan interval					
	1 ms	2 ms	5 ms	10 ms	20 ms	50 ms
Input.output	1	2	5	10	20	40
math	1	2	5	10	20	50
communication	3	6	15	30	60	150
Report	1	2	5	10	20	50

**GP20-2**

Channel	Scan interval					
	1 ms	2 ms	5 ms	10 ms	20 ms	50 ms
Input.output	5	10	25	40	40	40
math	2	4	10	20	40	100
communication	5	10	25	50	100	250
Report	2	4	10	20	40	60

- Measurement mode is Dual interval

**GP10**

Channel	Scan interval					
	1 ms	2 ms	5 ms	10 ms	20 ms	50 ms
Input.output	–	–	5	10	12	12
math	–	–	1	2	5	12
communication	–	–	1	2	5	12
Report	–	–	1	2	5	12

**GP20-1**

Channel	Scan interval					
	1 ms	2 ms	5 ms	10 ms	20 ms	50 ms
Input.output	–	–	5	10	20	40
math	–	–	2	5	10	25
communication	–	–	7	15	30	75
Report	–	–	2	5	10	25

**GP20-2**

Channel	Scan interval					
	1 ms	2 ms	5 ms	10 ms	20 ms	50 ms
Input.output	5	10	25	40	40	40
math	1	2	5	10	20	50
communication	2	5	12	25	50	125
Report	1	2	5	10	20	30



## Limit to the Number of Recording Channels in Each Measurement Mode

I/O channel + math channel + communication channel

Model	Measurement mode	Recording interval										
		1ms	2 ms	5 ms	10 ms	20 ms	50 ms	100 ms	200 ms	500 ms	1 s or more	
GP10	Normal	–	–	–	–	–	–	–	100	100	100	100
	High speed	1	4	9	20	32	62	100	100	100	100	100
	Dual interval	–	–	5	10	20	36	100	100	100	100	100
GP20-1	Normal	–	–	–	–	–	–	–	100	200	500	500
	High speed	2	4	10	20	40	100	100	200	200	500	500
	Dual interval	–	–	5	10	20	50	100	100	100	250	250
GP20-2	Normal	–	–	–	–	–	–	–	500	500	1000	1000
	High speed	10	20	50	100	150	150	200	500	500	1000	1000
	Dual interval	5	10	25	40	50	50	100	20	600	600	600

Note) Number of active recordable channels.

### Notes on Module Installation

- When the reference junction compensation of this product is used with the thermocouple input of a GX90XA-10-U2, GX90XA-10-L1, GX90XA-10-T1, GX90XA-10-V1 or GX90XA-04-H0, if the following module is installed to the right (slot with the smaller number) of the GX90XA module as seen from the GP rear panel, the reference junction compensation accuracy of that module may deviate from the guaranteed range (except when GX90XA-04-H0 is installed to adjacent slots).  
GX90XA-10-C1, GX90XA-04-H0, GX90WD, GX90YA, GX90UT
- On the GP20, when the reference junction compensation of this product is used with the thermocouple input of a GX90XA-10-U2, GX90XA-10-L1, GX90XA-10-T1, GX90XA-10-V1 or GX90XA-04-H0, if the following module is installed above, below, to the right, or to the left (slot with the smaller number) of the GX90XA module as seen from the GP rear panel, the reference junction compensation accuracy of that module may deviate from the guaranteed range.  
GX90YA, GX90UT
- If you want to use the DI of a GX90XD or GX90WD, only a single module installed in the GP main unit can be used.
- If the maximum number of I/O channels are assigned and the last channel is assigned to an intermediate channel of a connected I/O module, that module and subsequent modules will not be recognized.

#### Example GP10/GP20-1

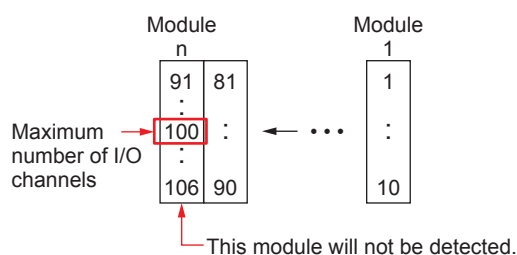

### Dual Interval File Searching of Universal Viewer

Recording mode	Link dual interval waveform <sup>*1</sup>	Show dual interval integrated link view <sup>*2</sup>
Free + Free	✓	✓
Free + Trigger (single/repeat)	–	–
Trigger (single/repeat) + Trigger (single/repeat)	–	–

\*1 Link dual interval waveform: A function that searches a folder for and displays the file that forms a pair with the displayed file.

\*2 Show dual interval integrated link view: A function that displays from the result of Search Open one of the files that forms a pair and displays both trends when it is clicked.

### PID program pattern setting from the Web application

You cannot set from the Web application. Hardware Configurator is required for setting program patterns.

## INPUT/OUTPUT MODULE SPECIFICATIONS

**ANALOG INPUT MODULE (Model GX90XA or Option /Uxx0)**

**DIGITAL INPUT MODULE (Model GX90XD or Options /CRx1)**

**DIGITAL OUTPUT MODULE (Model GX90YD, or Options /CR1x, /CR2x, /CR4x)**

**DIGITAL INPUT/OUTPUT MODULE (Model GX90WD)**

**PULSE INPUT MODULE (Model GX90XP)**

**ANALOG OUTPUT MODULE (Model GX90YA)**

**PID CONTROL MODULE (Model GX90UT)**

Please see GX90XA/GX90YA/GX90XD/GX90YD/GX90WD/GX90XP Input/Output Module and PID Control (GS 04L53B01-31EN) General Specification (GS 04L53B01-01EN.)

## APPLICATION SOFTWARE

SMARTDAC+ STANDARD

- Universal viewer
- Hardware configurator (with Program pattern setting)

Download the latest version of the software from the following URL;

[www.smartdacplus.com/software/en/](http://www.smartdacplus.com/software/en/)

### Operating environment

OS:

OS	Type
Windows 7	Home Premium SP1 (32-bit and 64-bit Editions)
	Professional SP1 (32-bit and 64-bit Editions)
Windows 8.1	Update
	Pro Update
Windows 10	Home (32-bit and 64-bit Editions)
	Pro (32-bit and 64-bit Editions)
	Enterprise (32-bit and 64-bit Editions)
	Enterprise LTSC (32-bit and 64-bit Editions)

Yokogawa will also stop supporting OSs that Microsoft Corporation no longer supports.

### Processor and main memory:

OS	Processor and main memory
Windows 7 Windows 8.1 Windows 10	32-bit edition Intel Pentium 4, 3GHz or faster x64 or x86, 2GB or more 64-bit edition Intel x64 processor that is equivalent to Intel Pentium 4, 3 GHz or faster, 2GB or more

### Browser:

Supported browser: Windows Internet Explorer 11  
HTTP1.1 and JavaScript are used.

### Hard disk:

- 100MB or more of free space

### Display:

- A Video card that is recommended for the OS and a display that is supported by the OS, has a resolution of 1024 x 768 or higher, and that can show 65,536 colors (16-bit, high color) or more.

### Universal Viewer software

The universal viewer can display the following data generated by the recorder on the screen and print it out on the printer.

- Display data file
- Event data file
- Report data file (Including Hour, Day, Week Month)
- Manual sample data file

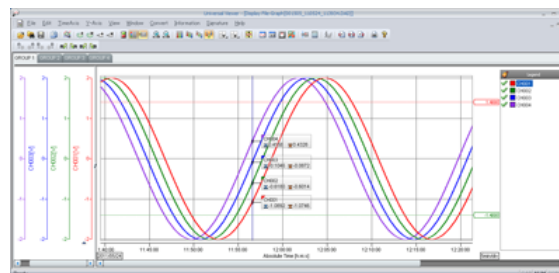

- Viewer function  
Waveform display, digital display, circular display, list display, report display, operation log display etc.
- Data conversion:  
File conversion to ASCII or MS-Excel format
- Signin function

### Web application/Hardware configurator

- Online setting on Web browser
  - Offline setting on Web browser
- Settings can be made using browsers such as Internet Explorer 11, Chrome (Excluding Hardware configurator).

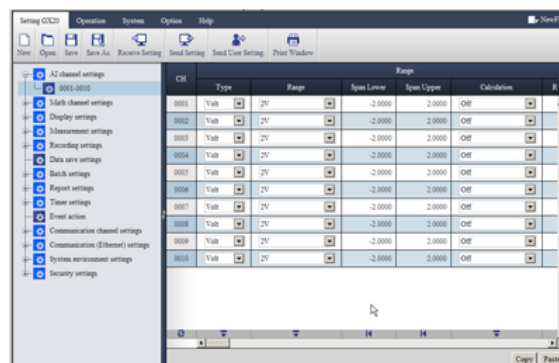



## ■ MODEL AND SUFFIX CODES

Model	Suffix Code			Optional code	Description
<b>GP10</b>					Paperless recorder (Portable type, Small display) <sup>*13</sup>
<b>GP20</b>					Paperless recorder (Portable type, Large display) <sup>*13</sup>
Type	<b>-1</b>				Standard (Max. measurement channels: 100 ch)
	<b>-2</b>				Large memory (Max. measurement channels: 500 ch) <sup>*12</sup>
Display language	<b>E</b>				English, degF, DST (summer/winter time) <sup>*9</sup>
Power supply		<b>1</b>			100 V AC, 240 V AC <sup>*16</sup>
		<b>2</b>			12 V DC <sup>*17</sup>
Power cord			<b>D</b>		Power cord UL/CSA standard
			<b>F</b>		Power cord VDE standard
			<b>R</b>		Power cord AS standard
			<b>Q</b>		Power cord BS standard
			<b>H</b>		Power cord GB standard
			<b>N</b>		Power cord NBR standard
			<b>W</b>		Screw terminal, power cord not included
Optional features			<b>/AH</b>		Aerospace heat treatment
			<b>/AS</b>		Advanced security function (Part 11) <sup>*23</sup>
			<b>/BT</b>		Multi-batch function <sup>*24</sup>
			<b>/C2</b>		RS-232 <sup>*1</sup>
			<b>/C3</b>		RS-422/485 <sup>*1</sup>
			<b>/CG</b>		Custom display <sup>*15</sup>
			<b>/D5</b>		VGA output <sup>*2</sup>
			<b>/E1</b>		EtherNet/IP communication (PLC communication protocol) <sup>*20</sup>
			<b>/E2</b>		WT communication <sup>*14</sup>
			<b>/E3</b>		OPC-UA server
			<b>/E4</b>		SLMP communication (Mitsubishi PLC) <sup>*21</sup>
			<b>/FL</b>		Fail output, 1 point
			<b>/LG</b>		Log scale
			<b>/MT</b>		Mathematical function (with report function) <sup>*18 *19</sup>
			<b>/MC</b>		Communication channel function <sup>*21</sup>
			<b>/PG</b>		Program control function <sup>*25</sup>
		<b>/UH</b>		USB interface (Host 2 ports)	

**Analog input module, Digital I/O module:**

Please add the following suffix codes to the main unit model and specification codes.

Option	Optional code	Description
Optional features (Analog input) <sup>*3*11</sup>	/UC10	With analog input module, 10ch (Clamp terminal)
	/UC20	With analog input module, 20ch (Clamp terminal) <sup>*7</sup>
	/UC30	With analog input module, 30ch (Clamp terminal) <sup>*8</sup>
	/UC40	With analog input module, 40ch (Clamp terminal) <sup>*5</sup>
	/UC50	With analog input module, 50ch (Clamp terminal) <sup>*5</sup>
	/US10	With analog input module, 10ch (M3 screw terminal)
	/US20	With analog input module, 20ch (M3 screw terminal) <sup>*7</sup>
	/US30	With analog input module, 30ch (M3 screw terminal) <sup>*8</sup>
	/US40	With analog input module, 40ch (M3 screw terminal) <sup>*5</sup>
	/US50	With analog input module, 50ch (M3 screw terminal) <sup>*5</sup>
Optional features (Digital I/O) <sup>*4</sup>	/CR01	With digital I/O module, (Output:0, Input:16) <sup>*8*9*18</sup>
	/CR10	With digital I/O module, (Output:6, Input:0) <sup>*8</sup>
	/CR11	With digital I/O module, (Output:6, Input:16) <sup>*7*8*9*18</sup>
	/CR20	With digital I/O module, (Output:12, Input:0) <sup>*6</sup>
	/CR21	With digital I/O module, (Output:12, Input:16) <sup>*6*9*18</sup>
	/CR40	With digital I/O module, (Output:24, Input:0) <sup>*6</sup>
	/CR41	With digital I/O module, (Output:24, Input:16) <sup>*6*9*18</sup>

\*1 /C2 and /C3 cannot be specified together.

\*2 /D5 can be specified only for the GP20.

\*3 Only one option can be specified.

\*4 Only one option can be specified.

\*5 /UC40, /UC50, /US40 and /US50 cannot be specified for the GP10.

\*6 /CR20, /CR21, /CR40 and /CR41 cannot be specified for the GP10.

\*7 If /UC20 or /US20 is specified, /CR11 cannot be specified for the GP10.

\*8 If /UC30 or /US30 is specified, /CR01, /CR10 and /CR11 cannot be specified for the GP10.

\*9 Digital input module have M3 screw terminals.

\*10 The Display language is selectable from English, German, French, Russian, Korean, Chinese, Italian, Japanese.

To confirm the current available languages, please visit the following website.

URL: <http://www.yokogawa.com/ns/language/>

\*11 Universal type (Type Suffix Code: -U2). If you need the electromagnetic relay type (Type Suffix Code: -T1), current (mA) input type (Type Suffix Code: -C1), Low withstand voltage relay, type (Type Suffix Code: -L1), High-speed universal type (Type Suffix Code: -H0), 4-wire RTD/resistance type (Type Suffix Code: -R1), purchase it separately.

\*12 Large memory type can be specified only for the GP20.

\*13 To connect an expandable I/O, GM sub unit, you will need one expansion module for the GP.

\*14 /MC must be separately specified when the WT communication is selected.

\*15 Creating custom displays requires DXA170 DAQStudio (sold separately). (GP does not have a creation function.)

\*16 Power code can be specified the suffix code D, F, R, Q, H, or N..

\*17 12 V DC power supply can be specified only for the GP10 without power code (suffix code: W).

\*18 Optional code /MT (MATH) required if using the GX90XD's or GX90WD's pulse input.

\*19 The /MT option (computation) is required to perform pulse integration on GX90XP pulse input modules.

\*20 If you want to write from a PLC to the GP via EtherNet/IP communication, a separate communication channel (/MC) is required.

\*21 A separate communication channel (/MC) is required to perform SLMP communication.

\*22 A communication channel (/MC) is required to configure the Modbus client function and for other devices to write to the GP Modbus server.

\*23 When the advanced security function is set to ON, the scan interval is set to 100 ms or longer. In addition, the dual interval function and PID modules cannot be used.

\*24 When the multi-batch function is set to ON, the scan interval is set to 500 ms or longer. In addition, the dual interval function cannot be used.

\*25 A PID control module is required to use the program control function.

## Module installation positions of analog input modules and digital I/O modules when they are preinstalled

### GP10

Module type	Optional code	Slot number		
		2	1	0
Analog Input (GX90XA-10-U2)	/UC10 or /US10	---	---	AI
	/UC20 or /US20	---	AI	AI
	/UC30 or /US30	AI	AI	AI
Digital I/O (GX90XD, GX90YD)	/CR01	---	---	DI
	/CR10	---	---	DO
	/CR11	---	DO	DI
Analog Input (GX90XA-10-U2 + Digital I/O (GX90XD, GX90YD)	/UC10 or /US10, /CR01	---	DI	AI
	/UC10 or /US10, /CR10	---	DO	AI
	/UC20 or /US20, /CR01	DI	AI	AI
	/UC20 or /US20, /CR10	DO	AI	AI

- Analog input modules specified with /U □□ 0 are installed in slots 0 to 2.
- Digital input and digital output modules specified with /CR □□ are installed in slots 0 and 1.  
The digital input module is installed with higher precedence than the digital output module.
- If both /U □□ 0 and /CR □□ are specified, the modules are installed to slots 0 to 2 in the following order of precedence: analog input, digital input, digital output.
- AI: GX90XA-10-U2N- □ N, DI: GX90XD-16-11N-3N, DO: GX90YD-06-11N-3N

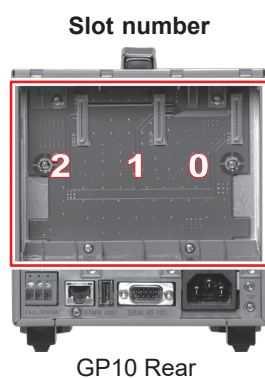

## GP20

Module type	Optional code	Slot number				
		9	8	7	6	5
		4	3	2	1	0
Analog Input (GX90XA-10-U2)	/UC10 or /US10	---	---	---	---	---
		---	---	---	---	AI
	/UC20 or /US20	---	---	---	---	---
		---	---	---	AI	AI
	/UC30 or /US30	---	---	---	---	---
		---	---	AI	AI	AI
	/UC40 or /US40	---	---	---	---	---
		---	AI	AI	AI	AI
	/UC50 or /US50	---	---	---	---	---
		AI	AI	AI	AI	AI
Digital I/O (GX90XD, X90YD)	/CR01	---	---	---	---	DI
		---	---	---	---	---
	/CR10	---	---	---	---	DO
		---	---	---	---	---
	/CR11	---	---	---	DO	DI
		---	---	---	---	---
	/CR20	---	---	---	DO	DO
		---	---	---	---	---
	/CR21	---	---	DO	DO	DI
		---	---	---	---	---
	/CR40	---	DO	DO	DO	DO
		---	---	---	---	---
	/CR41	DO	DO	DO	DO	DI
		---	---	---	---	---

- Analog input modules specified with /U □□ 0 are installed in slots 0 to 2.
- Digital input and digital output modules specified with /CR □□ are installed in slots 0 and 1.
- The digital input module is installed with higher precedence than the digital output module.
- If both /U □□ 0 and /CR □□ are specified, each module is installed in its corresponding position.
- AI: GX90XA-10-U2N- □ N, DI: GX90XD-16-11N-3N, DO: GX90YD-06-11N-3N



**Analog input/output module, Digital I/O module (sold separately):****MODEL and SUFFIX Code (GX90XA)****MODEL and SUFFIX Code (GX90XD)****MODEL and SUFFIX Code (GX90YD)****MODEL and SUFFIX Code (GX90WD)****MODEL and SUFFIX Code (GX90XP)****MODEL and SUFFIX Code (GX90YA)****MODEL and SUFFIX Code (GX90UT)**

Please see GX90XA/GX90XD/GX90YD/GX90WD/GX90XP/GX90YA Input/Output Module General Specification (GS 04L53B01-01EN.) and PID Control Module (GS 04L53B01-31EN)

**When connecting the Expandable I/O**

Please see GX60 Expandable I/O, GX90EX Expansion Module General Specification (GS 04L53B00-01EN.)

**■ Standard Accessories**

Product	Qty
SD memory card (1GB)	1
Stylus pen (touch pen)	1
Tag sheet (for GP10 or GP20)	1
Sheet (for GP10 or GP20)	1
Power cord	1*
Dummy cover (For empty slots)	-

\* Except GP10 power supply suffix code: 2

**■ Application Software (Sold Separately)**

Model	Description	OS
DXA170	DAQStudio software	Windows 8/8.1/10
GA10	Data Logging Software	Windows 7/8.1/10 Windows Server 2008/2012/2016

**■ Optional Accessories (Sold Separately)**

Product	Model/part no.
Model SD memory card (1GB)	773001
Stylus pen (touch pen)	B8740BZ
Shunt resistor for M3 terminal (250 $\Omega \pm 0.1 \%$ )	415940
Shunt resistor for M3 terminal (100 $\Omega \pm 0.1 \%$ )	415941
Shunt resistor for M3 terminal (10 $\Omega \pm 0.1 \%$ )	415942
Shunt resistor for Clamp terminal (250 $\Omega \pm 0.1 \%$ )	438920
Shunt resistor for Clamp terminal (100 $\Omega \pm 0.1 \%$ )	438921
Shunt resistor for Clamp terminal (10 $\Omega \pm 0.1 \%$ )	438922
Dummy cover	B8740CZ
Validation Documents (For /AS option)*1	773230

\*1 Provision of Validation Documents  
A license sheet containing the license key required for installation is provided.  
Download the validation document from the following URL.  
<http://www.smartdacplus.com/software/en/>

**Calibration certificate (sold separately)**

When ordering the GP10/GP20 with options (analog input), the calibration certificate for the modules is included in and shipped with the calibration certificate of the main unit. When ordering an analog input module separately, each module gets its own calibration certificate (one certificate per module).

**Test certificate (QIC, sold separately)**

When ordering the GP10/GP20 with options (analog/digital I/O), the QIC for each module is included in and shipped with the QIC of the main unit. When ordering analog input modules and digital I/O modules separately, each module gets its own QIC (one QIC per module).

**User's Manual**

Product user's manuals can be downloaded or viewed at the following URL. To view the user's manual, you need to use Adobe Reader 7 or later by Adobe Systems.

**URL:** [www.smartdacplus.com/manual/en/](http://www.smartdacplus.com/manual/en/)

**Product Purchase Specifications**

The GP10/GP20 is composed of the main unit, I/O modules, Expandable I/O, and Expansion module.

There are two ways to purchase I/O modules.

One way is to purchase them individually by specifying models GX90XA, GX90XD, GX90YD, GX90WD and GX90XP, GX90YA, GX90UT.

The other way is to purchase them as an option (/UCxx or /USxx). Purchasing them as an option is convenient, but this places limitations on the number of analog inputs that you can obtain.

If you want to use more than 50 channels, please purchase the I/O modules individually.

To connect expandable I/O (GX60), GM sub unit to GP10 or GP20, you must purchase one unit of expansion module (GX90EX) for GP10/GP20 in addition to the expandable I/O, GM sub unit.

**Trademarks**

The TCP/IP software used in this product and the document for that TCP/IP software are based in part on BSD networking software, Release 1 licensed from The Regents of the University of California.

- SMARTDAC+ is trademarks of Yokogawa Electric Corporation.
- Microsoft, MS and Windows are registered trademarks of Microsoft Corporation USA.
- Pentium are registered trademarks of Intel Corporation.
- Modbus is a registered trademark of AEG Schneider.
- Kerberos is a trademark of MIT.
- Other company and/or product names are registered trade mark of their manufactures.

## ■ MODEL SELECTION GUIDE

### Selection of the system configuration and GP10, GP20 type

Model-Type	Internal memory	Number of input/output channels	
		Main unit only	Main + expandable I/O
GP10	500 MB	48 ch (30 ch)	100 ch
GP20-1	500 MB	100 ch	100 ch
GP20-2	1.2 GB	100 ch	500 ch (450 ch)

\* The values inside parentheses are for when only analog input channels are available.

### I/O Modules

Model	Suffix code	Product name	Description	Number of channels	Measurement interval (shortest)
GX90XA	-10-C1N-□N	Analog Input Module	Current (mA) input DC current (mA), DC current standard signal (4-20mA)	10	100 ms
	-10-L1N-□N		Low withstand voltage relay DC voltage, standard signal, thermocouple (TC), DI (voltage, contact), and DC current (by adding an external shunt resistor)		500 ms
	-10-U2N-□N		Universal input DC voltage, standard signal, thermocouple (TC), resistance temperature detector (RTD), DI (voltage, contact), and DC current (by adding an external shunt resistor)		100 ms
	-10-T1N-□N		Electromagnetic relay DC voltage, standard signal, thermocouple (TC), DI (voltage, contact), and DC current (by adding an external shunt resistor)		1 s
	-10-V1N-□N		High withstand voltage DC voltage, standard signal, thermocouple (TC), DI (voltage, contact), and DC current (by adding an external shunt resistor)		100 ms
	-04-H0N- □ N		High-speed universal input DC voltage, standard signal, thermocouple, resistance temperature detector (RTD), DI (voltage, contact), DC current (when an external shunt resistor is connected)		4
	-06-R1N- □ N		4-wire RTD, 4-wire resistance	6	100 ms
GX90XD	-16-11N-□N	Digital Input Module	Remote control input, pulse input	16	100 ms
GX90XP	-10-11N-□N	Pulse Input Module	Pulse input (flow sum and the like)	10	100 ms
GX90YD	-06-11N-3N	Digital Output Module	Alarm output, etc	6	100 ms (update interval)
GX90WD	-0806-01N-3N	Digital Input/Output Module	Remote control input, pulse input	DI: 8 DO: 6	100 ms
GX90YA	-04-C1N-□N	Analog Output Module	Transmission output, manual output	4	100 ms(update interval)
GX90UT	-02-11N-3N	PID Control Module	Control of temperature, flow, pressure etc.	2 loops	100 ms(update interval)

## GP10 System Configuration (up to 100 channels)

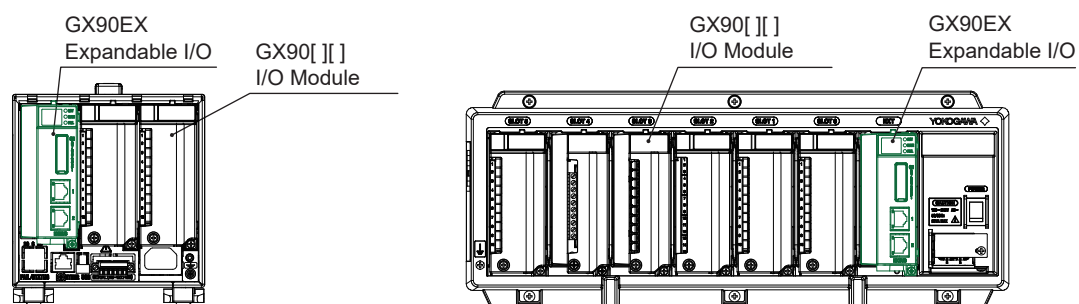

### GP10 Configuration example (maximum)

- GP10: 1
- GX90[ ][ ]: 2
- GX90EX: 1

### GX60 Configuration example (maximum)

- GX60: 2
- GX90[ ][ ]: 8
- GX90EX: 2 (Already installed in the GX60)

GP10  
(Unit 0)

SLOT 2	SLOT 1	SLOT 0
GX90EX	GX90[ ][ ]	GX90[ ][ ]

Expandable I/O)  
GX60  
(Unit 1)

SLOT 5	SLOT 4	SLOT 3	SLOT 2	SLOT 1	SLOT 0	EXT
GX90[ ][ ]	GX90[ ][ ]	GX90[ ][ ]	GX90[ ][ ]	GX90[ ][ ]	GX90[ ][ ]	GX90EX

Expandable I/O)  
GX60  
(Unit 2)

SLOT 5	SLOT 4	SLOT 3	SLOT 2	SLOT 1	SLOT 0	EXT
---	---	---	---	GX90[ ][ ]	GX90[ ][ ]	GX90EX



## GP20 System Configuration (up to 450 channels)

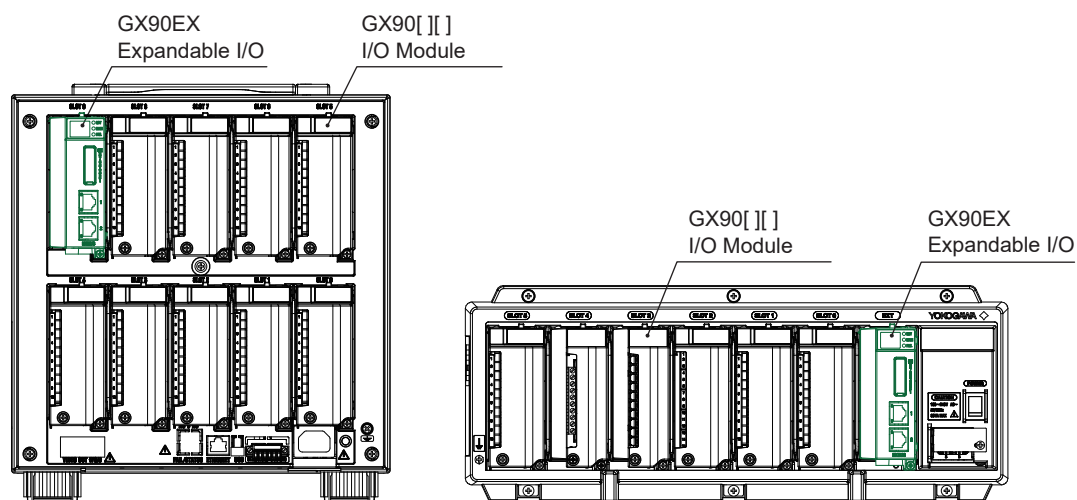

**GP20 Configuration example (maximum)**

- GP20: 1
- GX90[ ][ ]: 9
- GX90EX: 1

**GX60 Configuration example (maximum)**

- GX60: 6
- GX90[ ][ ]: 36
- GX90EX: 6 (Already installed in the GX60)

GP20  
(Unit 0)

SLOT 9	SLOT 8	SLOT 7	SLOT 6	SLOT 5
GX90EX	GX90[ ][ ]	GX90[ ][ ]	GX90[ ][ ]	GX90[ ][ ]
SLOT 4	SLOT 3	SLOT 2	SLOT 1	SLOT 0
GX90[ ][ ]	GX90[ ][ ]	GX90[ ][ ]	GX90[ ][ ]	GX90[ ][ ]

Expandable I/O)  
GX60  
(Unit 1)

SLOT 5	SLOT 4	SLOT 3	SLOT 2	SLOT 1	SLOT 0	EXT
GX90[ ][ ]	GX90[ ][ ]	GX90[ ][ ]	GX90[ ][ ]	GX90[ ][ ]	GX90[ ][ ]	GX90EX

Expandable I/O)  
GX60  
(Unit 2)

SLOT 5	SLOT 4	SLOT 3	SLOT 2	SLOT 1	SLOT 0	EXT
GX90[ ][ ]	GX90[ ][ ]	GX90[ ][ ]	GX90[ ][ ]	GX90[ ][ ]	GX90[ ][ ]	GX90EX

Expandable I/O)  
GX60  
(Unit 3)

SLOT 5	SLOT 4	SLOT 3	SLOT 2	SLOT 1	SLOT 0	EXT
GX90[ ][ ]	GX90[ ][ ]	GX90[ ][ ]	GX90[ ][ ]	GX90[ ][ ]	GX90[ ][ ]	GX90EX

Expandable I/O)  
GX60  
(Unit 4)

SLOT 5	SLOT 4	SLOT 3	SLOT 2	SLOT 1	SLOT 0	EXT
GX90[ ][ ]	GX90[ ][ ]	GX90[ ][ ]	GX90[ ][ ]	GX90[ ][ ]	GX90[ ][ ]	GX90EX

Expandable I/O)  
GX60  
(Unit 5)

SLOT 5	SLOT 4	SLOT 3	SLOT 2	SLOT 1	SLOT 0	EXT
GX90[ ][ ]	GX90[ ][ ]	GX90[ ][ ]	GX90[ ][ ]	GX90[ ][ ]	GX90[ ][ ]	GX90EX

Expandable I/O)  
GX60  
(Unit 6)

SLOT 5	SLOT 4	SLOT 3	SLOT 2	SLOT 1	SLOT 0	EXT
GX90[ ][ ]	GX90[ ][ ]	GX90[ ][ ]	GX90[ ][ ]	GX90[ ][ ]	GX90[ ][ ]	GX90EX

Blank

# General Specifications

GS 04L53B00-01EN

GX60  
I/O Base Unit (Expandable I/O)  
GX90EX  
Expansion Module

**SMARTDAC+**<sup>TM</sup>

## OVERVIEW

### GX60 I/O Base Unit (Expandable I/O)

The GX60 provides a function to expand an I/O module for recording and controlling, when it is connected to the expansion module that is connected to the GX10/GX20/GP10/GP20/GM using a LAN cable via a private communication network.

- One GX60 can install up to six I/O modules.
- Up to six units can be additionally connected to the GX/GP/GM.
- The communication distance between the GX/GP/GM and GX60 or between GX60s can be extended by up to 100 m using a LAN cable.
- \* When the measurement mode on the GX/GP/GM is High speed, expandable I/O units cannot be installed in the GX/GP/GM.

### GX90EX Expansion Module

The expansion module is installed in the GX10/GX20/GP10/GP20, GX60, GM main unit, and GM sub unit.

[If GX90EX expansion module is installed in the GX/GP or I/O base unit]

- The expansion module, which is supported by the GX/GP and GX60, enables a connection between GX/GP and GX60 or a communication between GX60s.
- A distributed arrangement with the data time synchronization secured is provided by connecting Expansion modules installed in the GX/GP main unit and GX60 using a LAN cable.
- Data is transferred to the high-order GX/GP via the expansion module.

[If GX90EX expansion module is installed in the GM main unit/sub unit]

- The expansion module, which is supported by the GM main unit and sub unit, enables a connection between GM main unit and sub unit or a communication between sub units.
- A distributed arrangement with the data time synchronization secured is provided by connecting Expansion modules installed in the GM main unit and sub unit using a LAN cable.
- Data is transferred to the high-order GM10 via the expansion module.

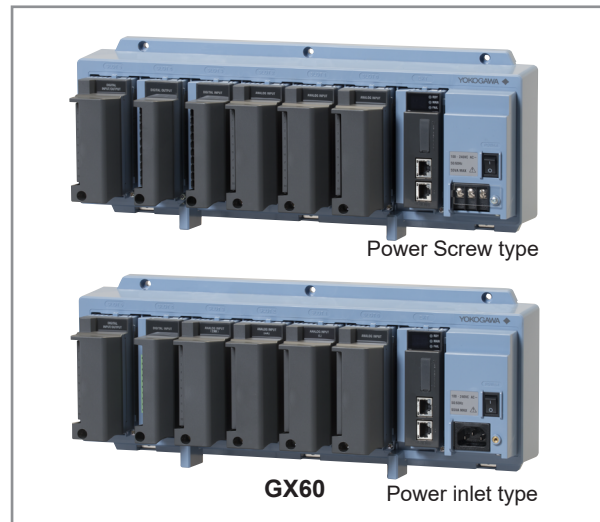

## ■ GX60 SPECIFICATIONS

### Module Installation

- I/O module: Max. 6 modules (Slots 0 to 5)

Modules that can be installed  
Please refer to the General Specifications of the GX90XA/GX90XD/GX90YD/GX90WD/GX90XP/GX90YA I/O Modules (GS 04L53B01-01EN) and GX90UT PID cControl Module (GS 04L53B01-31EN).

Restrictions:

Expansion module: 1 module (expansion module slot "EXT")

For other limitations, see the GX10/GX20 Paperless Recorder (Panel Mount Type) General Specifications (GS 04L51B01-01EN).

### Names of Channels

- The module installed in the GX60 has a channel name that consists of the unit number, slot number, and channel number.

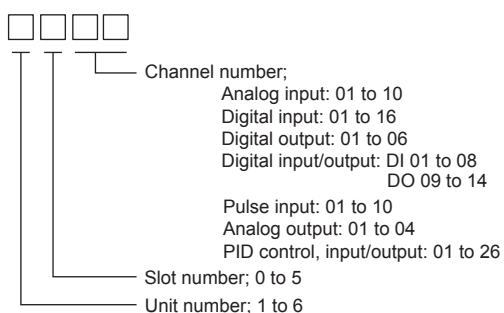
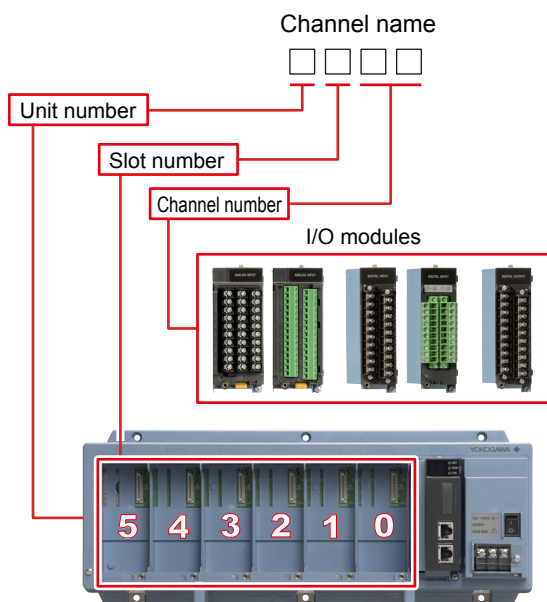

### Safety and EMC Standards

- CSA: CAN/CSA-C22.2 No.61010-1, CAN/CSA-C22.2 No. 61010-2-030, CAN/CSA-IEC 61010-2-201<sup>\*4</sup>, Overvoltage Category II<sup>\*1</sup>, Pollution Degree 2<sup>\*2</sup>, Measurement Category<sup>\*3</sup>
- UL: UL61010-1, UL61010-2-030, UL61010-2-201<sup>\*4</sup> (CSA NRTL/C), Overvoltage Category II<sup>\*1</sup>, Pollution Degree 2<sup>\*2</sup>, Measurement Category<sup>\*3</sup>
- CE/EMC directive: EN61326-1 Class A Table 2 (For use in industrial locations) compliant, EN61000-3-2 compliant, EN61000-3-3 compliant, EN55011 Class A Group 1 compliant
- CE/Low voltage directive: EN61010-1, EN61010-2-030, EN61010-2-201<sup>\*4</sup>, Overvoltage Category II<sup>\*1</sup>, Pollution degree 2<sup>\*2</sup>, Measurement Category<sup>\*3</sup>
- CE/RoHS directive: "2011/65/EU+(EU)2015/863" (10-Substances) compliant
- WEEE Directive: Compliant
- EMC Regulatory Arrangement in Australia and New Zealand (RCM): EN55011 Class A Group 1 compliant
- KC marking: KN11, KN61000-6-2 compliant

<sup>\*1</sup> Overvoltage Category II:

Describes a number which defines a transient overvoltage condition. Implies the regulation for impulse withstand voltage.

"II" applies to electrical equipment which is supplied from the fixed installation like a distribution board.

<sup>\*2</sup> Pollution Degree 2:

Describes the degree to which a solid, liquid, or gas which deteriorates dielectric strength or surface resistivity is adhering.

"2" applies to normal indoor atmosphere.

Normally, only non-conductive pollution occurs.

<sup>\*3</sup> Measurement Category:

Depends on the specification of each modules.

<sup>\*4</sup> This product is designed as open equipment

under the relevant standard, install it as follows:

- Install the GX60 in a panel with a door.
- The instrumentation panel or panel used for support must comply with CSA/UL/EN 61010-2-201 or must be at least IP1X (degrees of protection) and at least IK09.

## Construction

- Front panel (terminal): Water and dust-proof, Complies with IEC529-IP20
- Material: Polycarbonate, aluminum alloy
- Color;  
Bezel: Smoke blue (Munsell 4.1PB6.0/4.5 equivalent)
- Dimensions: 412.5 mm(W) x 164.7 mm(H) x 127.8 mm(D)
- Weight: Approx. 3.2 kg (installing 6 modules)

## Power Supply

- Rated supply voltage: 100 to 240 VAC
- Allowable power supply voltage range: 90 to 132, 180 to 264 VAC
- Rated power supply frequency: 50/60 Hz
- Power consumption:

Supply voltage	Normal operation *	Maximum
100 V AC	20 VA	40 VA
240 V AC	30 VA	55 VA

\* When using 6 analog input modules.

- Allowable interruption time: Less than 1 cycle of the power supply frequency

## Isolation

- Insulation resistance: Between each insulation terminals, and earth: 20 MΩ or greater at 500 VDC
- Withstand voltage:  
Between the power terminal and earth: 3000 V AC at 50/60 Hz for one minute  
Between the input/output modules and earth: Depends on the specification of I/O module.
- Grounding: Be sure to set a low grounding resistance.
- Isolation:

Power terminal	Input and output module terminal	
	Input and output module internal circuit	Internal circuit
	Earth (PE) terminal	

The circuits divided by lines are insulated mutually.

## External Dimensions

### Power screw terminal type

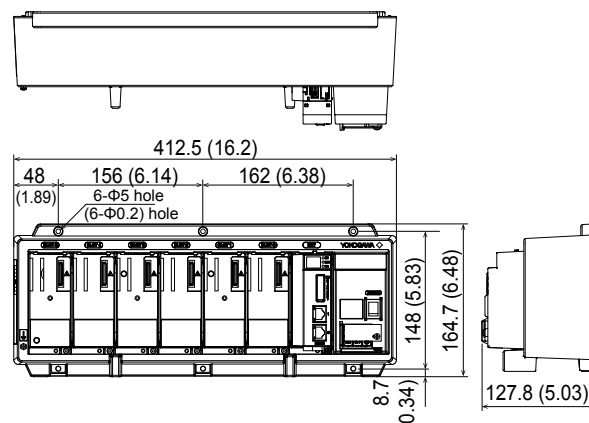

### Power inlet type

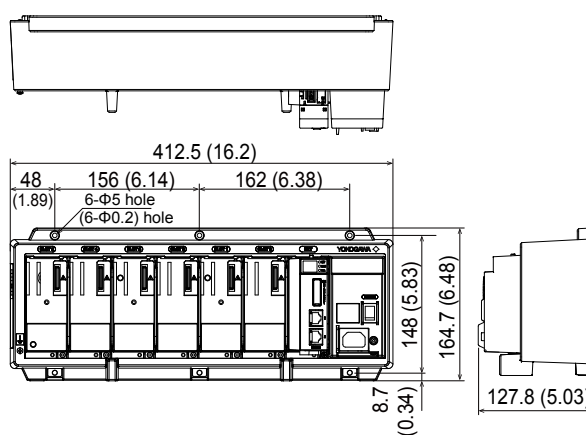

### With modules

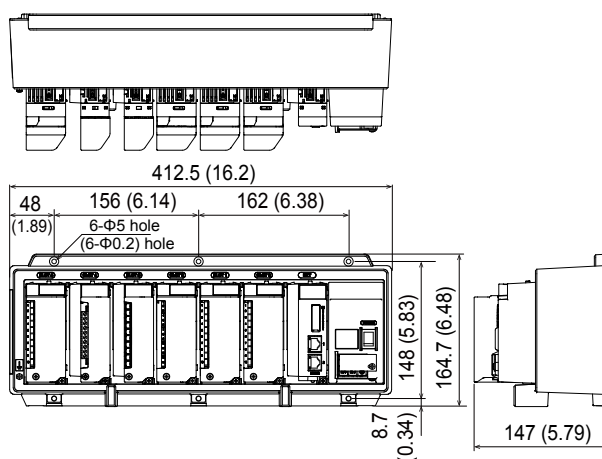

Dimensions of fixing hole

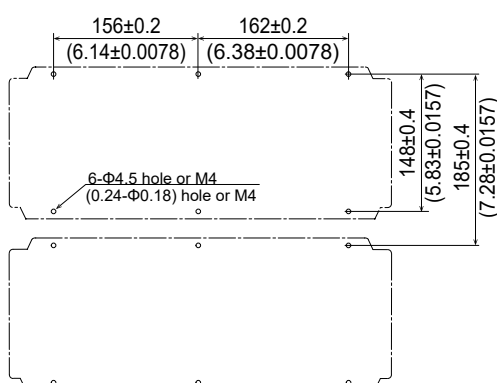

Unit: mm (approx. inch)

Unless otherwise specified, tolerance is  $\pm 3\%$  (however, tolerance is  $\pm 0.3$  mm when below 10 mm).

### Normal Operating Conditions

- Power supply voltage: 100 to 240 V AC  $\pm 10\%$
- Power supply frequency: 50/60 Hz  $\pm 2\%$
- Ambient temperature: 0 to 50 °C
- Ambient humidity: 20 to 80 %RH (However, less than moisture content of 40°C 80% RH at 40°C or more), No condensation
- Magnetic field: 400 A/m or less (DC and 50/60 Hz)
- Vibration:
  - 5 ≤ f < 8.4 Hz amplitude 3.5 mm (peak)
  - 8.4 ≤ f ≤ 160 Hz acceleration 9.8 m/s<sup>2</sup> or less
- Shock (IEC-60068-2-27):
  - Non-energization, 500 m/s<sup>2</sup> or less, approximate 10 ms, 6 directions ( $\pm X$ ,  $\pm Y$ ,  $\pm Z$ )
- Mounting position: Can be inclined up to 30 degrees backward. Left and right horizontal when installing the panel mount and wall mount.
- Altitude: 2000 m or less
- Installation location: Indoors
- Warm-up time: At least 30 minutes after power on

### Transport and Storage Conditions

- Ambient temperature: -25 to 60°C
- Ambient humidity: 5 to 95 %RH (no condensation)
- Vibration: 10 to 60 Hz, 4.9 m/s<sup>2</sup> maximum
- Shock: 392 m/s<sup>2</sup> maximum (in packaged condition)

### Effects of Operating Conditions

- Power supply variation: Shall satisfy the accuracy specification in the range of 90 to 132 VAC or 180 to 250 VAC (frequency: 50/60 Hz). Power supply frequency fluctuation: Shall satisfy the accuracy specification in the range of rated supply frequency  $\pm 2$  Hz (power-supply voltage: 100 VAC).

## ■ GX90EX SPECIFICATIONS

### Communication Functions

Communication between GX/GP and GX60, between GX60s, between GM main unit and sub unit, between GM sub units via dedicated communication network.

- Baud rate: 10Base-T/100Base-TX (Auto) \*1
- Number of ports: 2
- Connection cable: STP cable, CAT5 or greater
- Inter-module connection: Cascade connection (Ring connection is disabled.)
- Maximum communication distance: 100 m \*2
- Connector: RJ-45

\*1 Can be fixed to 10Base-T by DIP switch settings.

\*2 Distance extension through HUB connection or LAN repeaters is not possible.

### Display Functions

- System status LED indicators:
  - RDY (green): Lights up when the CPU is running normally.
  - MAIN (green): Turns on in master mode and off in slave mode.
  - FAIL (red): Lights up when a system error occurs.
- 7-segment LED indicator: Indicates a unit number or operation error.
- Ethernet status indicator LED: LINK ACT (green), SPEED (orange)

### Address Setting Functions

Switch settings:

Switch No.	Descriptions
1	For unit number setting
2	
3	
4	
5	-
6	-
7	10 Mbps/100 Mbps switching
8	MASTER/SLAVE switching

### Master / Slave Functions

Can be set to master mode (when installed in the GX/GP or GM main unit), or slave mode (when installed in the GX60 or GM sub unit) using the DIP switches.

### 10 Mbps Fixed Mode

Can be set to the 10 Mbps fixed mode using the DIP switches.

### Mounting

Can be mounted in the GX/GP, GX60, GM main unit, and GM sub unit.

- Mounting position:
  - GX10/GP10: Slot 2
  - GX20/GP20: Slot 9
  - GX60: EXT slot
  - GM main unit: Leftmost position
  - GM sub unit: Next to the power supply module

## Safety and EMC Standards

- CSA:  
CAN/CSA-C22.2 No.61010-1, Overvoltage Category II or I<sup>\*1</sup>, Pollution Degree 2<sup>\*2</sup>
- UL:  
UL61010-1 (CSA NRTL/C), Overvoltage Category II or I<sup>\*1</sup>, Pollution Degree 2<sup>\*2</sup>
- CE/EMC directive:  
EN61326-1 Class A Table 2 (For use in industrial locations) compliant  
EN61000-3-2 compliant  
EN61000-3-3 compliant  
EN55011 Class A Group 1 compliant
- CE/Low voltage directive  
EN61010-1, Overvoltage Category II or I<sup>\*1</sup>  
Pollution Degree 2<sup>\*2</sup>
- CE/RoHS directive:  
"2011/65/EU+(EU)2015/863" (10-Substances) compliant
- WEEE Directive: Compliant
- EMC Regulatory Arrangement in Australia and New Zealand (RCM): EN55011 Class A Group 1 compliant
- KC marking: KN11, KN61000-6-2 compliant

- \*1 Overvoltage Category:  
Describes a number which defines a transient overvoltage condition.  
Implies the regulation for impulse withstand voltage.  
II or I depends on the power supply specification of the GX/GP main unit, GM main unit or sub unit.
- \*2 Pollution Degree 2:  
Describes the degree to which a solid, liquid, or gas which deteriorates dielectric strength or surface resistivity is adhering.  
"2" applies to normal indoor atmosphere.  
Normally, only non-conductive pollution occurs.

## Construction

- Front panel (terminal): Water and dust-proof, Complies with IEC529-IP20
- Material: Polycarbonate
- Color;  
Front: Charcoal grey light (Munsell 10B3.6/0.3 equivalent)  
Bezel: Smoke blue (Munsell 4.1PB6.0/4.5 equivalent)
- Dimensions: 45.2 mm(W) x 111 mm(H) x 107.1 mm(D) (D: including terminal cover)
- Weight: Approx. 0.18 kg

## Power Supply

- Supply from GX/GP, GX60 expandable I/O, or GM90PS power supply module.
- Power consumption: 1.8W or less

## External Dimensions

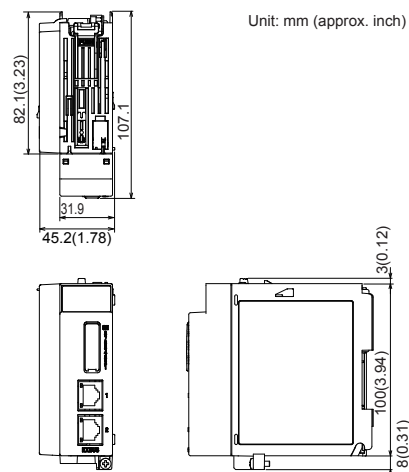

## Normal Operating Conditions

For normal operating conditions of this module, please refer to the General Specifications of the device (GX/GP, I/O Base Unit, or GM) that this module is mounted.

GX Specifications: GS 04L51B01-01EN

GP Specifications; GS 04L52B01-01EN

I/O Base Unit (Expandable I/O): This General Specifications

GM Specifications: GS 04L55B01-01EN

## Transport and Storage Conditions

- Ambient temperature: -25 to 70°C
- Ambient humidity: 5 to 95 %RH (no condensation)
- Vibration: 10 to 60 Hz, 4.9 m/s<sup>2</sup> maximum
- Shock: 392 m/s<sup>2</sup> maximum (in packaged condition)

## Effects of Operating Conditions

None



## ■ MODEL AND SUFFIX CODES

### MODEL and SUFFIX Code (GX60)

Model	Suffix Code			Description
<b>GX60</b>				I/O Base Unit
Type	<b>-EX</b>			I/O Expansion
Area		<b>N</b>		General
Power supply			<b>1</b>	100 V AC, 240 V AC
Power cord			<b>D</b>	Power cord UL/CSA standard
			<b>F</b>	Power cord VDE standard
			<b>R</b>	Power cord AS standard
			<b>Q</b>	Power cord BS standard
			<b>H</b>	Power cord GB standard
			<b>N</b>	Power cord NBR standard
			<b>W</b>	Screw terminal (M3)

\* One GX90EX (I/O expansion module) is provided.

### MODEL and SUFFIX Code (GX90EX)

Model	Suffix Code			Description
<b>GX90EX</b>				I/O Expansion Module
Port	<b>-02</b>			2 ports
Type		<b>-TP1</b>		Twisted Pair Cable
-			<b>N</b>	Always N
Area			<b>-N</b>	General

## ■ Standard Accessories

Product	Qty
Power cord	1*
Stopper (Antiskid rubber) (A9088ZM)	2

\* Except GX60 power cord suffix code: W

## ■ Optional Accessories (Sold Separately)

The dummy cover is for empty slots on GX/GP and GX60. The dummy cover is not attached to the GX60 when shipped from the factory. If you need the dummy cover, please purchase it separately.

Product	Part no.
Dummy cover	<b>B8740CZ</b>

### Test certificate (QIC, sold separately)

When ordering the GX60, GX90EX gets its own QIC (one QIC per unit).

When ordering the expansion modules separately, each module gets its own QIC (one QIC per module).

### User's Manual

Product user's manuals can be downloaded or viewed at the following URL. To view the user's manual, you need to use Adobe Reader 7 or later by Adobe Systems.

URL: [www.smartdacplus.com/manual/en/](http://www.smartdacplus.com/manual/en/)

### Trademarks

The TCP/IP software used in this product and the document for that TCP/IP software are based in part on BSD networking software, Release 1 licensed from The Regents of the University of California.

- SMARTDAC+ is registered trademarks of Yokogawa Electric Corporation.
- Microsoft, MS and Windows are registered trademarks of Microsoft Corporation USA.
- Pentium are registered trademarks of Intel Corporation.
- Modbus is a registered trademark of AEG Schneider.
- Other company and/or product names are registered trade mark of their manufactures.



# General Specifications

GX90XA/GX90XD/GX90YD/  
GX90WD/GX90XP/GX90YA  
I/O Modules

**SMARTDAC+**<sup>TM</sup>

GS 04L53B01-01EN

## OVERVIEW

I/O modules are connected to the GX/GP, Expandable I/O unit, GM main unit, and GM sub unit.

- A module type is seven types, an analog input, an analog output, a digital input, a digital output, a digital input/output and a pulse input PID control\*.
  - \* For the GX90UT PID Control Module, please see GX90UT PID Control Module General Specifications (GS 04L53B01-31EN.)
- Input and output have module structure and it can extend them easily.
- The GX90XA analog input module has the following types; (1) universal type that allows the measurement input for DCV (direct voltage), TC (thermocouple), RTD (resistance temperature detector), and DI (contact or TTL level voltage), (2) current input type with the built-in shunt resistor to directly input a standard signal of 4-20mA DC, (3) electromagnetic relay scanner type insusceptible to noises that allows the measurement input for DCV, TC, and DI, (4) low withstand voltage relay type that offers a low cost, (5) high withstand voltage type that 600 V withstand voltage between input terminal and ground.
 

The GX90XA-04-H0 high-speed analog input module can measure DCV (DC voltage), TC (thermocouple), RTD (resistance temperature detector), DI (contact or TTL level voltage) inputs at the shortest interval of 1 ms. It has an A/D converter for each input channel and employs a scannerless method, which is less susceptible to high frequency noise.

The GX90XA-06-R1 4-wire RTD/resistance input module can receive input from 4-wire RTDs or 4-wire resistors.

In each system, a measurement input signal can be assigned to each channel.
- The GX90YA analog output module is capable of retransmission output of various types of channels and also manual output. It provides current output with channels that are isolated.
- The GX90XD digital input module, which allows up to 16 digital inputs or pulse inputs, can be used as a multipoint digital input or pulse input. This module can also be used as a remote control input.
- The GX90YD digital output module is assigned as a relay output (contact C) and is used when an alarm activates. It can also be used to turn the output on and off manually using the touch panel.
- The GX90WD digital input/output module provides eight digital inputs or pulse inputs and six relay outputs. When there are small amounts of digital inputs and digital outputs, you do not need to mount two modules. This enables efficient channel configuration.
- GX90XP pulse input module can receive up to 10 pulse inputs. The maximum input frequency is 20 kHz. The module can be used to integrate pulse signals from flowmeters or the like.\*
  - \* Integration requires the math function (/MT option).



- Each module provides a M3 screw terminal and clamp terminal\*. Also, the input terminal can be removed and mounted. This enables wiring work to be carried out efficiently.
  - \* GX90YD and GX90WD are only M3 screw terminal.
- The measuring accuracies noted in the general specifications have a margin of error that takes into account the product's components and the equipment used for adjustment and testing. However, the actual values calculated from the accuracy testing data upon shipment of the instrument from the factory are as follows.

	Input Type	Measuring accuracy*1 (typical value*2)
DCV	20 mV	± (0.01% of rdg +5 μV)
	60 mV	± (0.01% of rdg +5 μV)
	6V (1-5V)	± (0.01% of rdg +2 mV)
TC <sup>3</sup>	R, S	±1.1°C
	B	±1.5°C
	K (-200.0 to 1370.0°C)	± (0.01% of rdg +0.2°C for 0.0 to 1370.0°C; ± (0.15% of rdg +0.2°C) for -200.0 to 0.0°C
	K (-200.0 to 500.0°C)	±0.2°C for 0.0 to 500.0°C; ± (0.15% of rdg +0.2°C) for -200.0 to 0.0°C
	J	± 0.2°C for 0.0 to 1100.0 °C; ± (0.10% of rdg + 0.2 °C) for -200.0 to 0.0 °C
	T	± 0.2°C for 0.0 to 400.0°C; ± (0.10% of rdg + 0.2 °C) for -200.0 to 0.0 °C
	N	± (0.01% of rdg + 0.2°C) for 0.0 to 1300.0 °C; ± (0.22% of rdg + 0.2°C) for -200.0 to 0.0 °C
RTD	Pt100 (-200.0 to 850.0°C)	± (0.02% of rdg + 0.2°C)
	Pt100 (high resolution) (-150.00 to 150.00°C)	± (0.02% of rdg + 0.16°C )

rdg: Reading value

- \*1 Applies to GX90XA-10-U2, A/D integration time 16.67 ms or more, General operating conditions: 23±2 °C, 55±10% RH, supply voltage 90–132, 180–264 V AC, power frequency within 50/60 Hz ±1%, warm-up of 30 minutes or more, no vibrations or other hindrances to performance.
- \*2 For the measuring accuracy (guaranteed), see page 3 to 4.
- \*3 These values do not include the reference junction compensation accuracy.

## INPUT/OUTPUT MODULE SPECIFICATIONS

### ANALOG INPUT MODULE (Model GX90XA or GX/GP main unit options /Uxx0)

The following notations are used to distinguish the various types.

Type Suffix Code	Notation
-U2	Universal
-C1	Current (mA) input
-L1	Low withstand voltage relay
-T1	Electromagnetic relay
-H0	High-speed universal
-R1	4-wire RTD/resistance
-V1	High withstand voltage



GX90XA

- Input Type:

Suffix Code	Input Type	Number of inputs	Description (Type)
-U2	DC voltage, standard signal, thermocouple (TC), resistance temperature detector (RTD), DI (voltage, contact), and DC current (by adding an external shunt resistor)	10	Universal
-C1	DC current (mA), DC current standard signal (4-20 mA)	10	Current (mA) input
-L1	DC voltage, standard signal, thermocouple (TC), DI (voltage, contact), and DC current (by adding an external shunt resistor)	10	Low withstand voltage relay
-T1	DC voltage, standard signal, thermocouple (TC), DI (voltage, contact), and DC current (by adding an external shunt resistor)	10	Electromagnetic relay
-H0	DC voltage, standard signal, thermocouple (TC), resistance temperature detector (RTD), DI (voltage, contact), and DC current (by adding an external shunt resistor)	4*1	High-speed universal
-R1	4-wire RTD, 4-wire resistance	6	4-wire RTD/resistance
-V1	DC voltage, standard signal, thermocouple (TC), DI (voltage, contact), and DC current (by adding an external shunt resistor)	10	High withstand voltage

\*1 However, 1 point when the scan interval is 1 ms and 2 points when it is 2 ms.

- Input format: Floating unbalanced, isolation between channels (excluding the b terminal on universal and low withstand voltage relay type)
- Measurement interval: 1, 2, 5, 10, 20, 50, 100, 200, 500 ms, 1, 2, 5 s (See the table below.)

Scan interval by module

Suffix Code	Scan interval											
	1 ms	2 ms	5 ms	10 ms	20 ms	50 ms	100 ms	200 ms	500 ms	1 s	2 s	5 s
-U2	-	-	-	-	-	-	✓	✓	✓	✓	✓	✓
-C1	-	-	-	-	-	-	✓	✓	✓	✓	✓	✓
-L1	-	-	-	-	-	-	-	-	✓	✓	✓	✓
-T1	-	-	-	-	-	-	-	-	-	✓	✓	✓
-H0	✓	✓	✓	✓	✓	✓	✓	✓	✓	✓	✓	✓
-R1	-	-	-	-	-	-	✓	✓	✓	✓	✓	✓
-V1	-	-	-	-	-	-	✓	✓	✓	✓	✓	✓

- Input range: -5% or more and 105% or less (accuracy is guaranteed in the range from 0% to 100% inclusive)
- Operation mode  
It is possible to switch to a mode that makes measurements by reducing the supply frequency noise.

Suffix Code	Operation mode
-U2	2 ch Only, Low noise mode or 10 ch Normal mode
-C1	2 ch Only, Low noise mode or 10 ch Normal mode
-L1	-
-T1	-
-H0	-
-R1	2 ch Only, Low noise mode or 6 ch Normal mode
-V1	2 ch Only, Low noise mode or 10 ch Normal mode

- Measurement ranges and accuracies<sup>2</sup> (However, the number of display digits can be increased by scaling.)

\*2 The following specifications apply to operation of the recorder under standard operation conditions.

Temperature: 23 ± 2 °C, Humidity: 55% ± 10% RH, Power supply voltage: 90 to 132 or 180 to 264 VAC, Power supply frequency: 50/60 Hz ± 1%, Warm-up time: At least 30 min. Other ambient conditions such as vibration should not adversely affect recorder operation.

Reference junction compensation accuracy is not included for thermocouples.

### Universal, Current (mA) input, Low withstand voltage relay, Electromagnetic relay, 4-wire RTD/resistor, High withstand voltage type

Input Type	Range	Measurement range	Measurement accuracy (digital display)		Max. resolution of digital display
			A/D integration time: 16.7ms or more <sup>22</sup>	A/D integration time: 1.67ms <sup>23</sup>	
DCV	20 mV	-20.000 to 20.000 mV	±(0.05 % of rdg + 12 µV)	±(0.1 % of rdg + 40 µV)	1 µV
	60 mV	-60.00 to 60.00 mV	±(0.05 % of rdg + 0.03 mV)	±(0.1 % of rdg + 0.15 mV)	10 µV
	200 mV	-200.00 to 200.00 mV	±(0.05 % of rdg + 0.03 mV)	±(0.1 % of rdg + 0.4 mV)	10 µV
	1 V	-1.0000 to 1.0000 V	±(0.05 % of rdg + 1.2 mV)	±(0.1 % of rdg + 4 mV)	100 µV
	2 V	-2.0000 to 2.0000 V	±(0.05 % of rdg + 1.2 mV)	±(0.1 % of rdg + 4 mV)	100 µV
	6 V	-6.000 to 6.000 V	±(0.05 % of rdg + 3 mV)	±(0.1 % of rdg + 15 mV)	1 mV
	20 V	-20.000 to 20.000 V	±(0.05 % of rdg + 3 mV)	±(0.1 % of rdg + 40 mV)	1 mV
	50 V	-50.00 to 50.00 V	±(0.05 % of rdg + 0.03 V)	±(0.1 % of rdg + 0.15 V)	10 mV
Standard signal	0.4-2 V	0.3200 to 2.0800 V	±(0.05 % of rdg + 1.2 mV)	±(0.1 % of rdg + 4 mV)	100 µV
	1-5 V	0.800 to 5.200 V	±(0.05 % of rdg + 3 mV)	±(0.1 % of rdg + 15 mV)	1 mV
DC current	0-20 mA	0.000 to 20.000 mA	±(0.3 % of rdg + 5 µA)	±(0.3 % of rdg + 90 µA)	1 µV
DC current (standard signal)	4-20 mA	3.200 to 20.800 mA			
TC (Excluding RJC accuracy)	R <sup>-3</sup>	0.0 to 1760.0 °C	±(0.15 % of rdg + 1.0°C)	±(0.2 % of rdg + 6.0°C)	0.1°C
	S <sup>-3</sup>	0.0 to 1760.0 °C	However, R, S; 0.0 to 800.0°C: ±2.2°C, B; 400.0 to 800.0°C: ±3.0°C	However, R, S; 0.0 to 800.0°C: ±7.6°C, B; 400.0 to 800.0°C: ±11.0°C	
	B <sup>-3</sup>	0.0 to 1820.0 °C	Accuracy at less than 400.0°C is not guaranteed.	Accuracy at less than 400.0°C is not guaranteed.	
	K <sup>-3</sup>	-270.0 to 1370.0 °C	±(0.15 % of rdg + 0.7°C)	±(0.2 % of rdg + 5.0°C)	0.1°C
		-200.0 to 500.0 °C	However, -200.0 to 0.0°C: ±(0.35 % of rdg + 0.7°C)	However, -200.0 to 0.0°C: ±(3 % of rdg + 5.0°C)	
	E <sup>-3</sup>	-270.0 to 800.0 °C	±(0.15 % of rdg + 0.5°C)	±(0.2 % of rdg + 4.0°C)	0.1°C
	J <sup>-3</sup>	-200.0 to 1100.0 °C	However, -200.0 to 0.0°C: ±(0.35 % of rdg + 0.5°C)	However, -200.0 to 0.0°C: ±(2 % of rdg + 4.0°C)	
	T <sup>-3</sup>	-270.0 to 400.0 °C	±(0.15 % of rdg + 0.5°C)	±(0.2 % of rdg + 2.5°C)	0.1°C
			However, -200.0 to 0.0°C: ±(0.35 % of rdg + 0.5°C)	However, -200.0 to 0.0°C: ±(2 % of rdg + 2.5°C)	
	N <sup>-3</sup>	-270.0 to 1300.0 °C	±(0.15 % of rdg + 0.7°C)	±(0.3 % of rdg + 6.0°C)	0.1°C
			However, -200.0 to 0.0°C: ±(0.7 % of rdg + 0.7°C)	However, -200.0 to 0.0°C: ±(5 % of rdg + 6.0°C)	
	W <sup>-4</sup>	0.0 to 2315.0 °C	±(0.15 % of rdg + 1.5°C)	±(0.3 % of rdg + 14.0°C)	0.1°C
				However, more than 1000.0°C: ±(0.8 % of rdg + 9.0°C)	
	L <sup>-5</sup>	-200.0 to 900.0 °C	±(0.15 % of rdg + 0.5°C)	±(0.2 % of rdg + 4.0°C)	0.1°C
			Less than 0.0°C: ±(0.5 % of rdg + 0.5°C)	Less than 0.0°C: ±(3 % of rdg + 4.0°C)	
	U <sup>-5</sup>	-200.0 to 400.0 °C	±(0.15 % of rdg + 0.5°C)	±(0.2 % of rdg + 2.5°C)	0.1°C
			Less than 0.0°C: ±(0.7 % of rdg + 0.5°C)	Less than 0.0°C: ±(3 % of rdg + 2.5°C)	
	WRe3-25 <sup>-6</sup>	0.0 to 2320.0 °C	±(0.2 % of rdg + 2.5°C)	±18.0°C	0.1°C
				More than 2000.0°C: ±0.9 % of rdg	
	KpvsAu7Fe <sup>-7</sup>	0.0 to 300.0 K	±(0.15 % of rdg + 2.0 K)	±(0.2 % of rdg + 7.0 K)	0.1 K
PLATINEL II <sup>-7</sup>	0.0 to 1395.0 °C	±(0.25 % of rdg + 2.3°C)	±(0.25% of rdg + 8.0°C)	0.1°C	
PR20-40 <sup>-8</sup>	0.0 to 1900.0°C	±(0.7 % of rdg + 0.4°C)	±20.0°C	0.1°C	
		However, accuracy at less than 800.0°C is not guaranteed.	However, accuracy at less than 800.0°C is not guaranteed.		
NiNiMo <sup>-7</sup>	0.0 to 1310.0°C	±(0.25 % of rdg + 0.7°C)	±(0.5 % of rdg + 5.0°C)	0.1°C	
W/WRe26 <sup>-9</sup>	0.0 to 2320.0°C	±(0.2 % of rdg + 2.0°C)	±(0.4 % of rdg + 12.0°C)	0.1°C	
		However, accuracy at less than 300.0°C is not guaranteed.	However, accuracy at less than 300.0°C is not guaranteed.		
N(AWG14) <sup>-10</sup>	0.0 to 1300.0°C	±(0.2 % of rdg + 1.3°C)	±(0.5 % of rdg + 7.0°C)	0.1°C	
XK GOST <sup>-11</sup>	-200.0 to 600.0°C	±(0.25 % of rdg + 0.8°C)	±(0.5 % of rdg + 4.0°C)	0.1°C	
Pt100 <sup>-12</sup>	-200.0 to 850.0°C	±(0.15 % of rdg + 0.3°C)	±(0.3 % of rdg + 1.5°C)	0.1°C	
	-150.00 to 150.00°C			0.01°C	
JPt100 <sup>-12</sup>	-200.00 to 550.00°C			0.1°C	
	-150.00 to 150.00°C			0.01°C	
RTD (Measured current: 1 mA)	Cu10 GE	-200.0 to 300.0°C	±(0.2 % of rdg + 2.0°C)	±(0.4 % of rdg + 6.0°C)	0.1°C
	Cu10 L&N	-200.0 to 300.0°C	guaranteed range	guaranteed range	
	Cu10 WEED	-200.0 to 300.0°C	Cu10 GE: -70.0 to 170.0°C	Cu10 GE: -70.0 to 170.0°C	
	Cu10 BAILEY	-200.0 to 300.0°C	Cu10 L&N: -75.0 to 150.0°C	Cu10 L&N: -75.0 to 150.0°C	
	Cu10 at 20°C α=0.00392	-200.0 to 300.0°C	Cu10 WEED: -200.0 to 260.0°C	Cu10 WEED: -200.0 to 260.0°C	
	Cu10 at 20°C α=0.00393	-200.0 to 300.0°C	Other range: -200.0 to 300.0°C	Other range: -200.0 to 300.0°C	
	Cu25 at 0°C α=0.00425	-200.0 to 300.0°C	±(0.3 % of rdg + 0.8°C)	±(0.5 % of rdg + 3.0°C)	0.1°C
	Cu53 at 0°C α=0.00426035	-50.0 to 150.0°C	±(0.15 % of rdg + 0.8°C)	±(0.3 % of rdg + 4.0°C)	0.1°C
	Cu100 at 0°C α=0.00425	-50.0 to 150.0°C	±(0.2 % of rdg + 1.0°C)	±(0.4 % of rdg + 5.0°C)	0.1°C

Continued

Input Type	Range	Measurement range	Measurement accuracy (digital display)		Max. resolution of digital display
			A/D integration time: 16.7ms or more <sup>22</sup>	A/D integration time: 1.67ms <sup>23</sup>	
RTD (Measured current: 1 mA)	J263B <sup>13</sup>	0.0 to 300.0 K	±1.0 K Less than 40.0 K: ±3.0 K ±(0.15 % of rdg + 0.4°C)	±3.0 K Less than 40.0 K: ±9.0 K ±(0.3 % of rdg + 2.0°C)	0.1 K
	Ni100 (SAMA)	-200.0 to 250.0°C			0.1°C
	Ni100 (DIN) <sup>14</sup>	-60.0 to 180.0°C			0.1°C
	Ni120 <sup>15</sup>	-70.0 to 200.0°C			0.1°C
	Pt25 <sup>16</sup>	-200.0 to 550.0°C	±(0.15 % of rdg + 0.8°C)	±(0.3 % of rdg + 4.0°C)	0.1°C
	Pt50 <sup>17</sup>	-200.0 to 550.0°C	±(0.3 % of rdg + 0.6°C)	±(0.6 % of rdg + 3.0°C)	0.1°C
	Pt200 WEED	-100.0 to 250.0°C	±(0.3 % of rdg + 1.0°C)		0.1°C
	Cu10 GOST <sup>18</sup>	-200.0 to 200.0°C	±(0.2 % of rdg + 2.0°C)	±(0.4 % of rdg + 6.0°C)	0.1°C
	Cu50 GOST <sup>19</sup>	-200.0 to 200.0°C	±(0.15 % of rdg + 0.6°C)	±(0.3 % of rdg + 4.0°C)	0.1°C
	Cu100 GOST <sup>20</sup>	-200.0 to 200.0°C	±(0.15 % of rdg + 0.3°C)	±(0.3 % of rdg + 1.5°C)	0.1°C
	Pt46 GOST <sup>19</sup>	-200.0 to 550.0°C	±(0.3 % of rdg + 0.8°C)	±(0.6 % of rdg + 4.0°C)	0.1°C
	Pt100 GOST <sup>20</sup>	-200.0 to 600.0°C	±(0.15 % of rdg + 0.3°C)	±(0.3 % of rdg + 2.0°C)	0.1°C
	4-wire RTD (Measured current: 1 mA)	Pt100 <sup>12</sup>	-200.0 to 850.0°C	±(0.05 % of rdg + 0.3°C)	±(0.1 % of rdg + 1.5°C)
JPt100 <sup>12</sup>		-150.00 to 150.00°C			0.01°C
Cu10 GE		-200.0 to 300.0°C	±(0.1 % of rdg + 2.0°C)	±(0.2 % of rdg + 5.0°C)	0.1°C
Cu10 L&N		-200.0 to 300.0°C	guaranteed range	guaranteed range	0.1°C
Cu10 WEED		-200.0 to 300.0°C	Cu10 GE: -70.0 to 170.0°C	Cu10 GE: -70.0 to 170.0°C	0.1°C
Cu10 BAILEY		-200.0 to 300.0°C	Cu10 L&N: -75.0 to 150.0°C	Cu10 L&N: -75.0 to 150.0°C	0.1°C
Cu10 at 20°C α = 0.00392		-200.0 to 300.0°C	Cu10 WEED: -200.0 to 260.0°C	Cu10 WEED: -200.0 to 260.0°C	0.1°C
Cu10 at 20°C α = 0.00393		-200.0 to 300.0°C	Other range: -200.0 to 300.0°C	Other range: -200.0 to 300.0°C	0.1°C
Cu25 at 0°C α = 0.00425		-200.0 to 300.0°C	±(0.1 % of rdg + 0.8°C)	±(0.2 % of rdg + 2.0°C)	0.1°C
Cu53 at 0°C α = 0.00426035		-50.0 to 150.0°C	±(0.05 % of rdg + 0.6°C)	±(0.1 % of rdg + 1.5°C)	0.1°C
Cu100 at 0°C α = 0.00425		-50.0 to 150.0°C	±(0.05 % of rdg + 0.3°C)	±(0.1 % of rdg + 1.5°C)	0.1°C
J263B <sup>13</sup>		0.0 to 300.0K	±0.4 K Less than 40.0 K: ±0.8 K ±(0.05 % of rdg + 0.3°C)	±1.5 K Less than 40.0 K: ±3.0 K ±(0.1 % of rdg + 1.5°C)	0.1K
Ni100 (SAMA)		-200.0 to 250.0°C			0.1°C
Ni100 (DIN) <sup>14</sup>		-60.0 to 180.0°C			0.1°C
Ni120 <sup>15</sup>		-70.0 to 200.0°C			0.1°C
Pt25 <sup>16</sup>		-200.0 to 550.0°C	±(0.1 % of rdg + 0.8°C)	±(0.2 % of rdg + 2.0°C)	0.1°C
Pt50 <sup>17</sup>		-200.0 to 550.0°C	±(0.05 % of rdg + 0.6°C)	±(0.1 % of rdg + 1.5°C)	0.1°C
Pt200 WEED		-100.0 to 250.0°C	±(0.05 % of rdg + 1.0°C)	±(0.1 % of rdg + 3.0°C)	0.1°C
Cu10 GOST <sup>18</sup>		-200.0 to 200.0°C	±(0.1 % of rdg + 2.0°C)	±(0.2 % of rdg + 5.0°C)	0.1°C
Cu50 GOST <sup>19</sup>		-200.0 to 200.0°C	±(0.05 % of rdg + 0.6°C)	±(0.1 % of rdg + 1.5°C)	0.1°C
Cu100 GOST <sup>20</sup>		-200.0 to 200.0°C	±(0.05 % of rdg + 0.3°C)	±(0.1 % of rdg + 1.5°C)	0.1°C
Pt46 GOST <sup>19</sup>		-200.0 to 550.0°C	±(0.05 % of rdg + 0.6°C)	±(0.1 % of rdg + 1.5°C)	0.1°C
Pt100 GOST <sup>20</sup>		-200.0 to 600.0°C	±(0.05 % of rdg + 0.3°C)	±(0.1 % of rdg + 1.5°C)	0.1°C
4-wire RTD (Measured current: 0.25 mA)	Pt500	-200.0 to 850.0°C	±(0.05 % of rdg + 0.3°C)	±(0.1 % of rdg + 1.5°C)	0.1°C
	Pt1000	-200.0 to 850.0°C			0.1°C
Resistance (4-wire)	20 Ω (Measured current: 1 mA)	0.0 to 20.000 Ω	±(0.05 % of rdg + 0.007Ω)	±(0.1 % of rdg + 0.025Ω)	0.001Ω
	200 Ω (Measured current: 1 mA)	0.0 to 200.00 Ω	±(0.05 % of rdg + 0.03Ω)	±(0.1 % of rdg + 0.15Ω)	0.01Ω
	2000 Ω (Measured current: 0.25 mA)	0.0 to 2000.0 Ω	±(0.05 % of rdg + 0.3Ω)	±(0.1 % of rdg + 1.0Ω)	0.1Ω
DI	Level		Threshold level (V <sub>th</sub> =2.4 V) Accuracy: ±0.1 V		-
	Contact <sup>21</sup>		Less than 1 kΩ: 1(ON), More than 100 kΩ: 0(OFF) (parallel capacitance of 0.01 μF or less)		-

rdg: Reading value

## High-speed universal type

Input Type	Range	Measurement range	Measurement accuracy (digital display)		Max. resolution of digital display
			Scan interval: 50 ms or more (Only the Values in [ ] apply when the scan interval is 50/100/200 ms)	Scan interval: 20 ms or less (Only the Values in [ ] apply when the scan interval is 1/2/5 ms)	
DCV	20 mV	-20.000 to 20.000 mV	$\pm(0.05\% \text{ of rdg} + 5 [12] \mu\text{V})$	$\pm(0.1\% \text{ of rdg} + 25 [40] \mu\text{V})$	1 $\mu\text{V}$
	60 mV	-60.00 to 60.00 mV	$\pm(0.05\% \text{ of rdg} + 0.02 \text{ mV})$	$\pm(0.1\% \text{ of rdg} + 0.1 \text{ mV})$	10 $\mu\text{V}$
	200 mV	-200.00 to 200.00 mV	$\pm(0.05\% \text{ of rdg} + 0.02 [0.03] \text{ mV})$	$\pm(0.1\% \text{ of rdg} + 0.1 [0.4] \text{ mV})$	10 $\mu\text{V}$
	1 V	-1.0000 to 1.0000 V	$\pm(0.05\% \text{ of rdg} + 0.2 \text{ mV})$	$\pm(0.1\% \text{ of rdg} + 1.0 \text{ mV})$	100 $\mu\text{V}$
	2 V	-2.0000 to 2.0000 V	$\pm(0.05\% \text{ of rdg} + 0.5 [1.2] \text{ mV})$	$\pm(0.1\% \text{ of rdg} + 1.0 [4.0] \text{ mV})$	100 $\mu\text{V}$
	6 V	-6.000 to 6.000 V	$\pm(0.05\% \text{ of rdg} + 2 \text{ mV})$	$\pm(0.1\% \text{ of rdg} + 10 \text{ mV})$	1 mV
	20 V	-20.000 to 20.000 V	$\pm(0.05\% \text{ of rdg} + 2 [3] \text{ mV})$	$\pm(0.1\% \text{ of rdg} + 10 [40] \text{ mV})$	1 mV
	50 V	-50.00 to 50.00 V	$\pm(0.05\% \text{ of rdg} + 0.02 \text{ V})$	$\pm(0.1\% \text{ of rdg} + 0.10 \text{ V})$	10 mV
	100 V	-100.00 to 100.00 V	$\pm(0.05\% \text{ of rdg} + 0.02 \text{ V})$	$\pm(0.1\% \text{ of rdg} + 0.10 \text{ V})$	10 mV
Standard signal	0.4-2 V	0.3200 to 2.0800 V	$\pm(0.05\% \text{ of rdg} + 0.5 [1.2] \text{ mV})$	$\pm(0.1\% \text{ of rdg} + 1.0 [4.0] \text{ mV})$	100 $\mu\text{V}$
	1-5 V	0.800 to 5.200 V	$\pm(0.05\% \text{ of rdg} + 2 \text{ mV})$	$\pm(0.1\% \text{ of rdg} + 10 \text{ mV})$	1 mV
TC (Excluding RJC accuracy)	R <sup>-3</sup>	0.0 to 1760.0 °C	$\pm(0.05\% \text{ of rdg} + 1.0^\circ\text{C})$	$\pm(0.1\% \text{ of rdg} + 4.0 [6.0]^\circ\text{C})$	0.1 °C
	S <sup>-3</sup>	0.0 to 1760.0 °C	However, R, S; 0.0 to 800.0°C: $\pm 1.4^\circ\text{C}$ , B; 400.0 to 800.0°C: $\pm 1.5 [3.0]^\circ\text{C}$	However, R, S; 0.0 to 800.0°C: $\pm 4.8 [7.6]^\circ\text{C}$ , B; 400.0 to 800.0°C: $\pm 7.0 [11.0]^\circ\text{C}$	
	B <sup>-3</sup>	0.0 to 1820.0 °C	Accuracy at less than 400.0°C is not guaranteed.	Accuracy at less than 400.0°C is not guaranteed.	
	K <sup>-3</sup>	-270.0 to 1370.0 °C	$\pm(0.05\% \text{ of rdg} + 0.7^\circ\text{C})$	$\pm(0.1\% \text{ of rdg} + 3.5^\circ\text{C})$	0.1 °C
		-200.0 to 500.0 °C	However, -200.0 to 0.0°C: $\pm(0.2\% \text{ of rdg} + 0.7^\circ\text{C})$ Accuracy at less than -200.0°C is not guaranteed	However, -200.0 to 0.0°C: $\pm(2\% \text{ of rdg} + 3.5^\circ\text{C})$ Accuracy at less than -200.0°C is not guaranteed	
	E <sup>-3</sup>	-270.0 to 800.0 °C	$\pm(0.05\% \text{ of rdg} + 0.5^\circ\text{C})$	$\pm(0.1\% \text{ of rdg} + 2.5^\circ\text{C})$	0.1 °C
	J <sup>-3</sup>	-200.0 to 1100.0 °C	However, -200.0 to 0.0°C: $\pm(0.2\% \text{ of rdg} + 0.5^\circ\text{C})$ Accuracy at less than -200.0°C is not guaranteed	However, -200.0 to 0.0°C: $\pm(2\% \text{ of rdg} + 2.5^\circ\text{C})$ Accuracy at less than -200.0°C is not guaranteed	
	T <sup>-3</sup>	-270.0 to 400.0 °C	$\pm(0.05\% \text{ of rdg} + 0.5^\circ\text{C})$	$\pm(0.1\% \text{ of rdg} + 2.5^\circ\text{C})$	0.1 °C
			However, -200.0 to 0.0°C: $\pm(0.2\% \text{ of rdg} + 0.5^\circ\text{C})$ Accuracy at less than -200.0°C is not guaranteed	However, -200.0 to 0.0°C: $\pm(2\% \text{ of rdg} + 2.5^\circ\text{C})$ Accuracy at less than -200.0°C is not guaranteed	
	N <sup>-3</sup>	-270.0 to 1300.0 °C	$\pm(0.05\% \text{ of rdg} + 0.7^\circ\text{C})$	$\pm(0.1\% \text{ of rdg} + 4.0^\circ\text{C})$	0.1 °C
			However, -200.0 to 0.0°C: $\pm(0.5\% \text{ of rdg} + 0.7^\circ\text{C})$ Accuracy at less than -200.0°C is not guaranteed	However, -200.0 to 0.0°C: $\pm(3.5\% \text{ of rdg} + 4.0^\circ\text{C})$ Accuracy at less than -200.0°C is not guaranteed	
	W <sup>-4</sup>	0.0 to 2315.0 °C	$\pm(0.05\% \text{ of rdg} + 1.0^\circ\text{C})$	$\pm(0.1\% \text{ of rdg} + 7.0^\circ\text{C})$	0.1 °C
	L <sup>-5</sup>	-200.0 to 900.0 °C	$\pm(0.05\% \text{ of rdg} + 0.5^\circ\text{C})$	However, more than 1000.0°C: $\pm(0.8\% \text{ of rdg})$	0.1 °C
			Less than 0.0°C: $\pm(0.25\% \text{ of rdg} + 0.5^\circ\text{C})$	Less than 0.0°C: $\pm(3\% \text{ of rdg} + 4.0^\circ\text{C})$	
	U <sup>-5</sup>	-200.0 to 400.0 °C	$\pm(0.05\% \text{ of rdg} + 0.5^\circ\text{C})$	$\pm(0.1\% \text{ of rdg} + 2.5^\circ\text{C})$	0.1 °C
	WRe3-25 <sup>-6</sup>	0.0 to 2320.0 °C	$\pm(0.05\% \text{ of rdg} + 2.0^\circ\text{C})$	$\pm(0.1\% \text{ of rdg} + 8.0^\circ\text{C})$	0.1 °C
			More than 2000.0°C: $\pm(0.15\% \text{ of rdg})$	Less than 200.0°C: 12.0 °C More than 2000.0°C: $\pm(0.1\% \text{ of rdg} + 13.0^\circ\text{C})$	
KpvsAu7Fe <sup>-7</sup>	0.0 to 300.0 K	$\pm(0.05\% \text{ of rdg} + 0.7 [2.0] \text{ K})$	$\pm(0.1\% \text{ of rdg} + 3.5 [7.0] \text{ K})$	0.1 K	
PLATINEL II <sup>-7</sup>	0.0 to 1395.0 °C	$\pm(0.05\% \text{ of rdg} + 1.0^\circ\text{C})$	$\pm(0.1\% \text{ of rdg} + 4.0^\circ\text{C})$	0.1 °C	
PR20-40 <sup>-8</sup>	0.0 to 1900.0 °C	$\pm(0.05\% \text{ of rdg} + 2.5 [5.5]^\circ\text{C})$	$\pm(0.1\% \text{ of rdg} + 12.0 [18.0]^\circ\text{C})$	0.1 °C	
		However, accuracy at less than 800.0°C is not guaranteed.	However, accuracy at less than 800.0°C is not guaranteed.		
NiNiMo <sup>-7</sup>	0.0 to 1310.0 °C	$\pm(0.05\% \text{ of rdg} + 0.7^\circ\text{C})$	$\pm(0.1\% \text{ of rdg} + 2.7^\circ\text{C})$	0.1 °C	
W/WRe26 <sup>-9</sup>	0.0 to 2320.0 °C	$\pm(0.05\% \text{ of rdg} + 2.0^\circ\text{C})$	$\pm(0.1\% \text{ of rdg} + 10.0^\circ\text{C})$	0.1 °C	
		However, accuracy at less than 300.0°C is not guaranteed.	However, accuracy at less than 300.0°C is not guaranteed.		
N(AWG14) <sup>-10</sup>	0.0 to 1300.0 °C	$\pm(0.05\% \text{ of rdg} + 0.7^\circ\text{C})$	$\pm(1.0\% \text{ of rdg} + 4.0^\circ\text{C})$	0.1 °C	
XK GOST <sup>-11</sup>	-200.0 to 600.0 °C	$\pm(0.05\% \text{ of rdg} + 0.5^\circ\text{C})$	$\pm(0.1\% \text{ of rdg} + 2.5^\circ\text{C})$	0.1 °C	
		Less than 0.0°C: $\pm(0.2\% \text{ of rdg} + 0.5^\circ\text{C})$	Less than 0.0°C: $\pm(1\% \text{ of rdg} + 2.5^\circ\text{C})$		



Continued

Input Type	Range	Measurement range	Measurement accuracy (digital display)		Max. resolution of digital display
			Scan interval: 50 ms or more (Only the Values in [ ] apply when the scan interval is 50/100/200 ms)	Scan interval: 20 ms or less (Only the Values in [ ] apply when the scan interval is 1/2/5 ms)	
RTD (Measured current: 1 mA)	Pt100 <sup>*13</sup>	-200.0 to 850.0°C	±(0.05 % of rdg + 0.3°C)	±(0.1 % of rdg + 1.5°C)	0.1°C
		-150.00 to 150.00°C			0.01°C
	JPt100 <sup>*13</sup>	-200.0 to 550.0°C	±(0.1 % of rdg + 0.8°C)	±(0.2 % of rdg + 2.0°C)	0.1°C
		-150.00 to 150.00°C			0.01°C
	Cu25 at 0°C α=0.00425	-200.0 to 300.0°C	±(0.05 % of rdg + 0.6°C)	±(0.1 % of rdg + 1.5°C)	0.1°C
	Cu53 at 0°C α=0.00426035	-50.0 to 150.0°C	±(0.05 % of rdg + 0.3°C)	±(0.1 % of rdg + 1.5°C)	0.1°C
	Cu100 at 0°C α=0.00425	-50.0 to 150.0°C	±(0.05 % of rdg + 0.3°C)	±(0.1 % of rdg + 1.5°C)	0.1°C
	J263B <sup>*14</sup>	0.0 to 300.0 K	±4.0 K Less than 40.0 K: ±0.8 K	±1.5 K Less than 40.0 K: ±3.0 K	0.1 K
	Ni100 (SAMA)	-200.0 to 250.0°C	±(0.05 % of rdg + 0.3°C)	±(0.1 % of rdg + 1.5°C)	0.1°C
	Ni100 (DIN) <sup>*15</sup>	-60.0 to 180.0°C	±(0.1 % of rdg + 0.8°C)	±(0.2 % of rdg + 2.0°C)	0.1°C
	Ni120 <sup>*16</sup>	-70.0 to 200.0°C			
	Pt25 <sup>*17</sup>	-200.0 to 550.0°C	±(0.05 % of rdg + 0.6°C)	±(0.1 % of rdg + 1.5°C)	0.1°C
	Pt50 <sup>*18</sup>	-200.0 to 550.0°C	±(0.05 % of rdg + 1.0°C)	±(0.1 % of rdg + 3.0°C)	0.1°C
	Pt200 WEED	-100.0 to 250.0°C	±(0.05 % of rdg + 0.6°C)	±(0.1 % of rdg + 1.5°C)	0.1°C
	Cu50 GOST <sup>*20</sup>	-200.0 to 200.0°C	±(0.05 % of rdg + 0.3°C)	±(0.1 % of rdg + 1.5°C)	0.1°C
	Cu100 GOST <sup>*21</sup>	-200.0 to 200.0°C	±(0.05 % of rdg + 0.6°C)	±(0.1 % of rdg + 1.5°C)	0.1°C
	Pt46 GOST <sup>*20</sup>	-200.0 to 550.0°C	±(0.05 % of rdg + 0.3°C)	±(0.1 % of rdg + 1.5°C)	0.1°C
Pt100 GOST <sup>*21</sup>	-200.0 to 600.0°C	±(0.1 % of rdg + 0.7 [2.0]°C)	±(0.2 % of rdg + 2.5 [5.0]°C)	0.1°C	
RTD (Measured current: 1.6 mA)	Cu10 GE	-200.0 to 300.0°C	guaranteed range	guaranteed range	0.1°C
	Cu10 L&N	-200.0 to 300.0°C	Cu10 GE: -70.0 to 170.0°C	Cu10 L&N: -75.0 to 150.0°C	
	Cu10 WEED	-200.0 to 300.0°C	Cu10 L&N: -75.0 to 150.0°C	Cu10 WEED: -200.0 to 260.0°C	
	Cu10 BAILEY	-200.0 to 300.0°C	Cu10 WEED: -200.0 to 260.0°C	Other range: -200.0 to 300.0°C	
	Cu10 at 20°C α=0.00392	-200.0 to 300.0°C	Other range: -200.0 to 300.0°C		
	Cu10 at 20°C α=0.00393	-200.0 to 300.0°C			
	Cu10 GOST <sup>*19</sup>	-200.0 to 200.0°C	±(0.1 % of rdg + 0.7 [2.0]°C)	±(0.2 % of rdg + 2.5 [5.0]°C)	
DI	Level		Threshold level (Vth=2.4 V) Accuracy: ±0.1 V	-	
	Contact <sup>*22</sup>		Less than 100 Ω: 1(ON), More than 10 kΩ: 0(OFF)	-	

rdg: Reading value

\*3 R, S, B, K, E, J, T, N: IEC60584-1, DIN EN60584, JIS C1602, ASTM E230

\*4 W: W-5%Re/W-26%Re(Hoskins Mfg.Co.) ASTM E988-96

(Type C equivalent of OMEGA Engineering Inc.)

\*5 L: Fe-CuNi, DIN43710, U: Cu-CuNi, DIN43710

\*6 WRe3-25: W-3%Re/W-25%Re(Hoskins Mfg.Co.) ASTM E988-96

(Type D equivalent of OMEGA Engineering Inc.)

\*7 KpvsAu7Fe, PLATINEL II, NiNiMo: ASTM E1751

\*8 PR20-40: PtRh20%-PtRh40%(Johnson Matthey Plc) ASTM E1751

\*9 W/WRe26: W/W-26%Re(Hoskins Mfg.Co.) ASTM E1751

(Type G equivalent of OMEGA Engineering Inc.)

\*10 N(AWG14): NBS

\*11 XK GOST: Type L (GOST R 8.525-2001)

\*12 Pt100: JIS C1604, IEC60751, DIN EN60751

JPt100: JIS C1604, JIS C1606

\*13 J263B: Yokogawa Electric Corporation J263\*B

\*14 Ni100 (DIN): DIN 43760

\*15 Ni120: McGRAW EDISON COMPANY

\*16 Pt25: One-fourth of JPt100 resistance value

\*17 Pt50: JIS C1604, JIS C1606

\*18 Cu10 GOST: One-tenth of Cu100 GOST resistance value

\*20 Cu50 GOST, Pt46 GOST: GOST 6651-94

\*20 Cu100 GOST, Pt100 GOST: GOST 6651-2009

\*21 The detected current value is approx. 10 μA.

\*22 10 channel mode with scan interval set to 500 ms or higher, or 2 channel mode

\*23 10 channel mode with scan interval set to 100 ms or 200 ms

Measurement accuracy at scaling: measurement accuracy at scaling (digits) = measurement accuracy (digits) × scaling span (digits)/measurement span (digits) + 1 digit

\* Rounding up decimal places

- Burnout detection<sup>\*1 \*2</sup>: Burnout upscale, downscale, or OFF selectable (for each channel).
  - Available input: TC, RTD, Standard signal
  - Detection condition; TC; Universal, Low withstand voltage relay, Electromagnetic relay, High withstand voltage type
    - Normal: 2 kΩ or less., Burnout: 200 kΩ or more (parallel capacitance of 0.01 μF or less)
    - Detection current: Approx. 10 μA
  - High-speed universal type
    - Detection current: Approx. 50 nA, Superposed electric current system
  - RTD; Universal type
    - Normal: wiring resistance or less, Burnout: 200 kΩ or more parallel capacitance of less than 0.01 μF or less
    - Detection current: Approx. 10 μA
  - High-speed universal type
    - Detection current: Approx. 100 nA, Superposed electric current system
  - Standard signal:
    - Normal: Within measuring range
    - Burnout: Depends on the setting of the burnout judgment value. The burnout judgment value shall be set with the percentage of the specified span width.
    - Lower limit: -20.0 to -5.0 %
    - Upper limit: 105 to 120 %
- \*1 None for the 4-wire RTD/resistance type
- \*2 If the scan interval on the high speed AI module is 1 to 20 ms, burnout detection will not work correctly.
- Input external resistance:
  - DC voltage, thermocouple input: 2 kΩ or below
  - Resistance temperature detector input: 10 Ω or below in each wire (Same resistance in three wires)
- Input bias current: ±10 nA or less (when burnout function does not work)
- Measured current (for RTD):
  - universal type: Approx. 1 mA
  - High-speed universal type: Approx. 1 mA/1.6 mA (depends on the range)
  - 4-wire RTD/resistance: Approx. 1 mA/0.25 mA (depends on the range)
- Input resistance:
  - 10 MΩ or more for TC/DC voltage (1 V range or less) input
  - Approx. 1 MΩ for DC voltage (2 V range or more)/standard signal input/DI voltage (High-speed universal type)/while measurement is stopped (High-speed universal type)
  - 250 Ω (249.5 Ω typ) for DC mA
  - \* typ: Typical value (Typical)
- Allowable signal source resistance: 2 kΩ or less for TC/DC voltage (1 V range or less) input
- Effect of signal source resistance:
  - ±10 μV/1kΩ or less for TC/DC voltage (1 V range or less) input
  - ±0.15 % of rdg/1kΩ or less for DC voltage (2 V range or more)/standard signal input
- Allowable wiring resistance: Max. 10 Ω per line for RTD input (conductor resistance between the three lines shall be equal)
- Effect of wiring resistance: ±0.1°C/10 Ω for RTD input (conductor resistance between the three lines shall be equal), ±1°C/10 Ω (50Ω system or less, High-speed universal type)
  - 4-wire RTD/resistance type
    - 4-wire RTD100 Ω system or more: ±0.1°C/10 Ω
    - 4-wire RTD50 Ω system or less: ±1°C/10 Ω
    - Resistance 20 Ω: ± 0.001 Ω or less
    - Resistance 200 Ω: ± 0.01 Ω or less
    - Resistance 2000 Ω: ± 0.1 Ω or less
- Allowable input voltage:
  - Universal, Low withstand voltage relay, Electromagnetic relay, High withstand voltage type:
    - ±10 V DC for TC/DC voltage (1 V range or less)/RTD/DI (contact) input, DC mA
    - ±60 V DC for DC voltage (2 V range or more) input/DI (level) input
  - High-speed universal type:
    - ±120 V DC
- Allowable input current (current (mA) input type): 24 mA, 50/60 Hz, peak value including signal
- Noise reduction ratio
  - Universal, Low withstand voltage relay, current (mA) input, Electromagnetic relay, 4-wire RTD/resistance, High withstand voltage type:

Integration time *1	Normal mode	Common mode
1.67 ms	50/60 Hz, no noise reduction	More than 80 dB *2 *4
More than 16.67 ms	More than 40 dB *2 *3	More than 120 dB *2 *4

High-speed universal type:

Scan interval *1	Normal mode	Common mode
20 ms or less	50/60 Hz, no noise reduction	More than 80 dB *2 *4
More than 50 ms	More than 40 dB *2 *3	More than 120 dB *2 *4

\*1 A frequency discrimination setting is made in the main unit.

\*2 A resistance temperature detector range is a converted value of voltage when a measured current flows.

\*3 50/60 Hz ± 0.1 %

\*4 50/60 Hz ± 0.1%, 500 Ω imbalance, between minus measuring terminal and ground

- Normal mode voltage for TC/ DC voltage (1 V range or less)/DI (voltage): 1.2 times or less of rated range

Standard signal 0.4 to 2 V range: 2.4 V

Standard signal 1-5 V range: 6 V

RTD (100 Ω system or more) : 50 mV peak

RTD (50 Ω system or less) : 10 mV peak

\* 50/60Hz, The peak value including the signal.

4-wire RTD/resistance

Resistance (2000 Ω), RTD (100 Ω, 500 Ω

1000 Ω system): 50 mV peak

Resistance (200 Ω), RTD (10 Ω, 25 Ω 50 Ω

system): 10 mV peak

Resistance (20 Ω): 4 mV peak

- Normal mode current (current (mA) input type): 24 mA DC (Value converted to voltage: 6V)

\* 50/60 Hz, The peak value including the signal.

- Common mode voltage for measuring input: 30 V ACrms (50/60Hz) or  $\pm 60$  V DC (Maximum common mode noise voltage for measuring input: 250 V ACrms)  
High-speed universal type only  
300 V ACrms (50/60Hz), Double insulation  
High withstand voltage type only  
600 V ACrms (50/60Hz) or 600 V DC, Double insulation  
1000 V DC, Basic insulation\*

\* When the module is used under basic insulation conditions, external supplementary insulation is required for safe use. When the system is used in a common mode voltage environment that exceeds 600 V, to add supplementary insulation, you need to install the system in a panel, add an overcurrent protection device, and add an insulation device. Refer to the First Step Guide (IM 04L51B01-02EN, IM 04L55B01-02EN), and take the appropriate measures.

- Maximum voltage between measuring input channels: 30 V ACrms (50/60 Hz) or  $\pm 60$  V DC (Maximum common mode noise voltage between measuring input channels: 250 V ACrms (60 V ACrms for low-voltage relay type))  
High-speed universal type  
300 V ACrms (50/60Hz), Double insulation
- Reference junction compensation accuracy:  
When measuring temperature greater than or equal to 0 °C and when Integral time 16.6 ms or more or scan interval 50 ms or more (for the high-speed universal type) and when input terminal temperature is balanced  
Type K, E, J, T, N, XK GOST:  $\pm 0.5$  °C (23 °C  $\pm$  2 °C),  $\pm 0.7$  °C (0 to 50 °C),  $\pm 1.0$  °C (-20 to 60 °C)  
Type R, S, W, L, U, W97Re3-W75Re25, Platinel2, NiNiMo, W/WRe26, N(AWG14):  $\pm 1.0$  °C (23 °C  $\pm$  2 °C),  $\pm 1.4$  °C (0 to 50 °C),  $\pm 2.0$  °C (-20 to 60 °C)  
Type KpvsAu7Fe:  $\pm 1.0$  K (23 °C  $\pm$  2 °C),  $\pm 1.4$  K (0 to 50 °C),  $\pm 2.0$  K (-20 to 60 °C)  
Type B, PR20-40: Internal reference compensation is fixed to 0 °C
- Scan interval/A/D integration time:  
10 ch. mode, 6 ch mode<sup>3</sup>

Universal <sup>1</sup>, Current (mA) input <sup>1</sup>, 4-wire RTD/resistance, High withstand voltage <sup>1</sup> type

Scan interval	Integration time
100 ms/200 ms	1.67 ms
500 ms or more	16.67 ms/20 ms
1 s	36.67 ms
2 s or more	100 ms

Electromagnetic relay scanner type

Scan interval	Integration time
1 s or more	16.67 ms/20 ms
2 s	36.67 ms
5 s	100 ms

Low withstand voltage relay type

Scan interval	Integration time
500 ms or more	16.67 ms/20 ms
2 s	36.67 ms
5 s	100 ms

2 ch. mode<sup>2</sup>

Scan interval	Integration time
100 ms or more	16.67 ms/20 ms
1 s	36.67 ms
2 s or more	100 ms

\*1 In 10ch mode, when the scan interval is set to 100 ms or 200 ms, the A/D integration time is fixed at 1.67 ms. This prevents power frequency noise from being eliminated, causing measured values to wobble.

\*2 Cannot be specified for the electromagnetic relay type, Low withstand voltage relay type, High-speed universal type.

\*3 For the 4-wire RTD/resistance type.

- Scan interval/filter type:  
High-speed universal type

Scan interval	Filter
20 ms or less	Non*
50 ms/100 ms/200 ms	50 Hz/60 Hz Simultaneous removal of 50 Hz and 60 Hz
500 ms or more	50 Hz/60 Hz/10 Hz

\* With the high-speed universal type, when the scan interval is 20 ms or less, supply frequency noise is not removed. As such, the measured values may fluctuate especially in temperature measurement using thermocouples.

- Calibration correction:  
Mode: Linearizer Approximation, Linearizer Bias  
Number of correcting points: 12
- Moving average function:  
Can be switched On/Off (Settable for each channel)  
Moving average number can be selected from 2 to 100 times  
Select from 2 to 500 for the high-speed universal type.
- First-order lag input filter (high-speed universal type): Can be turned on/off for each channel  
Time constant: Scan interval  $\times$  N where N is between 3 and 300)
- Reference junction compensation:  
Mode: Can be switch internal or external (Settable for each channel)  
(Set the value of the compensation temperature at external)
- Input calculation:  
Linear scaling, square root\*, differential calculations (Settable for each channel)
- \* Not available for the 4-wire RTD/resistance type
- Bias function:  
Can be set the bias value to be added to the input value (Settable for each channel)
- Terminal type: M3 screw terminal or Clamp terminal
- Withstand voltage  
Universal, Electromagnetic relay, 4-wire RTD/resistance type;  
Between the input terminals and the internal circuit: 3000 V AC for one minute  
Between the analog input channels: 1000VAC for one minute (excluding b-terminal)  
Current (mA) input type;  
Between the input terminals and the internal circuit: 1500 V AC for one minute  
Between the analog input channels: 1000 V AC for one minute (excluding b-terminal)



- Low withstand voltage type;  
 Between the input terminals and the internal circuit: 1500 V AC for one minute  
 Between the analog input channels: 400 V AC for one minute (excluding b-terminal)
- High-speed universal type;  
 Between the input terminals and the internal circuit: 3000 V AC for one minute  
 Between the analog input channels: 3000 V AC for one minute
- High withstand voltage  
 Between the input terminals and the internal circuit: 3700 V AC for one minute  
 Between the analog input channels: 1000 V AC for one minute
- Insulation resistance:  
 Between the input terminals and the internal circuit: 20 MΩ or greater at 500 V DC  
 Between the analog input channels\*: 20 MΩ or greater at 500 V DC
  - \* Excludes the b terminal of the universal type
  - Recommended replacement period of electromagnetic relay scanner type modules:  
 Electromagnetic relay scanner type modules make measurements by switching mechanical contact relays on and off.  
 To ensure that the modules continue to operate reliably and correctly, replace them  
 Continuous use at measurement interval 1 s: 1 year  
 Continuous use at measurement interval 2 s: 2 years  
 Continuous use at measurement interval 5 s: 5 years

### Safety and EMC Standards

- CSA:  
 CAN/CSA-C22.2 No.61010-1, CAN/CSA-C22.2 No.61010-2-030, Overvoltage Category II or I<sup>\*1</sup>, Pollution Degree 2<sup>\*2</sup>, Measurement Category II<sup>\*4</sup>
  - UL:  
 UL61010-1, UL 61010-2-030 (CSA NRTL/C), Overvoltage Category II or I<sup>\*1</sup>, Pollution Degree 2<sup>\*2</sup>, Measurement Category II<sup>\*4</sup>
  - CE/EMC directive<sup>\*3</sup>:  
 EN61326-1, Class A Table 2 (For use in industrial locations) compliance  
 EN61000-3-2 compliance  
 EN61000-3-3 compliance  
 EN55011 Class A Group 1 compliance
  - CE/Low voltage directive<sup>\*3</sup>:  
 EN61010-1, EN 61010-2-030, Overvoltage Category II or I<sup>\*1</sup>, Pollution degree 2<sup>\*2</sup>, Measurement category II<sup>\*3</sup>
  - CE/RoHS directive:  
 "2011/65/EU+(EU)2015/863" (10-Substances) Compliant
  - EMC Regulatory Arrangement in Australia and New Zealand (RCM): EN55011 Class A Group 1 compliance
  - KC marking: KN11, KN61000-6-2 compliance
- \*1 Overvoltage category: Describes a number which defines a transient overvoltage condition. Implies the regulation for impulse withstand voltage. Applies to electrical equipment which is supplied from the fixed installation like a distribution board. II or I depends on the power supply specification of the main unit.

- \*2 Pollution degree 2:  
 Describes the degree to which a solid, liquid, or gas which deteriorates dielectric strength or surface resistivity is adhering.  
 "2" applies to normal indoor atmosphere.  
 Normally, only non-conductive pollution occurs.
  - \*3 The CE standards for modules represent standards that are met when the module is installed in the main unit.
  - \*4 Measurement category II (CAT II):  
 Applies to measuring circuits connected to low voltage installation, and electrical instruments supplied with power from fixed equipment such as electric switchboards.
- WEEE Directive: Compliant

### Construction

- Front panel (terminal): Water and dust-proof, Complies with IEC529-IP20
- Material: Polycarbonate
- Color;  
 Front: Charcoal grey light (Munsell 10B3.6/0.3 equivalent)  
 Bezel: Smoke blue (Munsell 4.1PB6.0/4.5 equivalent)
- Dimensions: 45.2 mm(W) x 111 mm(H) x 133.1 mm(D) (D: including terminal cover)
- Weight: Approx. 0.3 kg

### Power Supply

Supply from GX/GP, GX60 expandable I/O, GM90PS power supply module.

- Power consumption:  
 GX90XA-10-U2: 0.7 W or less  
 GX90XA-10-T1: 0.9 W or less  
 GX90XA-10-C1: 0.7 W or less  
 GX90XA-10-L1: 0.7 W or less  
 GX90XA-04-H0: 2.0 W or less  
 GX90XA-06-R1: 0.7 W or less  
 GX90XA-10-V1: 1.0 W or less

## Isolation

Universal, Low withstand voltage relay,  
Electromagnetic relay, Current (mA) input type

Analog input CH1	Input circuit	Internal circuit
Analog input CH2		
Analog input CH3		
Analog input CH4		
Analog input CH5		
Analog input CH6		
Analog input CH7		
Analog input CH8		
Analog input CH9		
Analog input CH10		

———— Functional insulation

===== Reinforced insulation

### High withstand voltage type

Analog input CH1	Input circuit	Internal circuit
Analog input CH2		
Analog input CH3		
Analog input CH4		
Analog input CH5		
Analog input CH6		
Analog input CH7		
Analog input CH8		
Analog input CH9		
Analog input CH10		

———— Functional insulation

===== Double insulation (600 V ACrms 50/60 Hz,  
600 V DC) or Basic insulation (1000 V DC)

### High-speed universal type

Analog input CH1	Internal circuit
Analog input CH2	
Analog input CH3	
Analog input CH4	

===== Double insulation (300 Vrms 50/60Hz)

### 4-wire RTD/resistance type

Analog input CH1	Input circuit	Internal circuit
Analog input CH2		
Analog input CH3		
Analog input CH4		
Analog input CH5		
Analog input CH6		

———— Functional insulation

===== Reinforced insulation

## Terminal arrangements

### M3 screw terminal

Universal, Low withstand voltage relay,  
Electromagnetic relay, Current (mA) input, High  
withstand voltage type

No.	Symbol	No.	Symbol	No.	Symbol
301	CH1( /b)*1	201	CH1(-/B)	101	CH1(+/A)
302	CH2( /b)*1	202	CH2(-/B)	102	CH2(+/A)
303	CH3( /b)*1	203	CH3(-/B)	103	CH3(+/A)
304	CH4( /b)*1	204	CH4(-/B)	104	CH4(+/A)
305	CH5( /b)*1	205	CH5(-/B)	105	CH5(+/A)
306	CH6( /b)*1	206	CH6(-/B)	106	CH6(+/A)
307	CH7( /b)*1	207	CH7(-/B)	107	CH7(+/A)
308	CH8( /b)*1	208	CH8(-/B)	108	CH8(+/A)
309	CH9( /b)*1	209	CH9(-/B)	109	CH9(+/A)
310	CH10( /b)*1	210	CH10(-/B)	110	CH10(+/A)

\*1 There are no symbol indications for the electromagnetic relay type, current (mA) input type, low withstand voltage relay type, or high withstand voltage type.

\* RTD input terminal b is shorted internally across all channels.

### High-speed universal type

No.	Symbol	No.	Symbol	No.	Symbol
301	CH1( /A)	201	CH1(-/b)	101	CH1(+/B)
304	CH2( /A)	204	CH2(-/b)	104	CH2(+/B)
307	CH3( /A)	207	CH3(-/b)	107	CH3(+/B)
310	CH4( /A)	210	CH4(-/b)	110	CH4(+/B)

### 4 wire RTD/resistance type

No.	Symbol	No.	Symbol	No.	Symbol
301	CH1(B)	201	CH1(A)	101	CH1(I)
302	CH1(C)	202	Not Used	102	CH2(C)
303	CH2( B)	203	CH2(A)	103	CH2(I)
304	CH3( B)	204	CH3(A)	104	CH3(I)
305	CH3( C)	205	Not Used	105	CH4(C)
306	CH4( B)	206	CH4(A)	106	CH4(I)
307	CH5( B)	207	CH5(A)	107	CH5(I)
308	CH5( C)	208	Not Used	108	CH6(C)
309	CH6(B)	209	CH6(A)	109	CH6(I)
310	Not Used	210	Not Used	110	Not Used

**Clamp terminal**

Universal, Low withstand voltage relay,  
Electromagnetic relay, Current (mA) input type, High  
withstand voltage type

No.	Symbol	No.	Symbol
201	CH2(+/A)	101	CH1(+/A)
202	CH2(-/B)	102	CH1(-/B)
203	CH2( /b) *1	103	CH1( /b) *1
204	CH4(+/A)	104	CH3(+/A)
205	CH4(-/B)	105	CH3(-/B)
206	CH4( /b) *1	106	CH3( /b) *1
207	CH6(+/A)	107	CH5(+/A)
208	CH6(-/B)	108	CH5(-/B)
209	CH6( /b) *1	109	CH5( /b) *1
210	CH8(+/A)	110	CH7(+/A)
211	CH8(-/B)	111	CH7(-/B)
212	CH8( /b) *1	112	CH7( /b) *1
213	CH10(+/A)	113	CH9(+/A)
214	CH10(-/B)	114	CH9(-/B)
215	CH10( /b) *1	115	CH9( /b) *1

\*1 There are no symbol indications for the electromagnetic relay type, current (mA) input type, low withstand voltage relay type, or high withstand voltage type.

\* RTD input terminal b is shorted internally across all channels.

**4-wire RTD/resistance**

No.	Symbol	No.	Symbol
201	CH2(I)	101	CH1(I)
202	CH2(A)	102	CH1(A)
203	CH2(B)	103	CH1(B)
204	CH2(C)	104	CH1(C)
205	Not Used	105	Not Used
206	CH4(I)	106	CH3(I)
207	CH4(A)	107	CH3(A)
208	CH4(B)	108	CH3(B)
209	CH4(C)	109	CH3(C)
210	Not Used	110	Not Used
211	CH6(I)	111	CH5(I)
212	CH6(A)	112	CH5(A)
213	CH6(B)	113	CH5(B)
214	CH6(C)	114	CH5(C)
215	Not Used	115	Not Used

**A/D Calibration Value**

Two types of A/D calibration values (factory shipment setting and user setting) can be saved. If the user setting is not proper, it can be restored to the calibration value at factory shipment.

**High-speed universal type**

No.	Symbol	No.	Symbol
201	CH1(+/B)	101	Not Used
202	CH1(-/b)	102	Not Used
203	CH1( /A)	103	Not Used
204	Not Used	104	Not Used
205	CH2(+/B)	105	Not Used
206	CH2(-/b)	106	Not Used
207	CH2(/A)	107	Not Used
208	Not Used	108	Not Used
209	CH3(+/B)	109	Not Used
210	CH3(-/b)	110	Not Used
211	CH3( /A)	111	Not Used
212	Not Used	112	Not Used
213	CH4(+/B)	113	Not Used
214	CH4(-/b)	114	Not Used
215	CH4( /A)	115	Not Used

**External Dimensions**

- Except high speed universal type and high withstand voltage type

**M3 screw terminal**

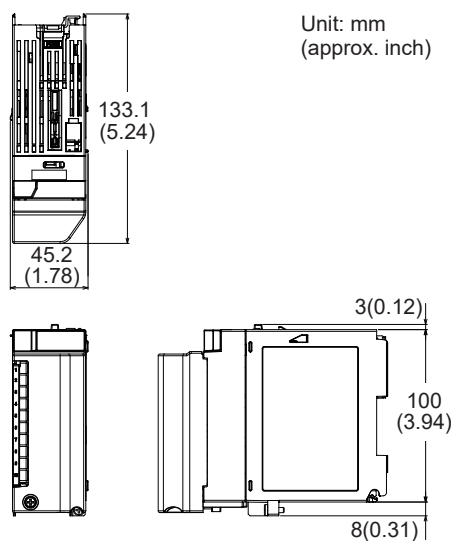

**Clamp terminal**

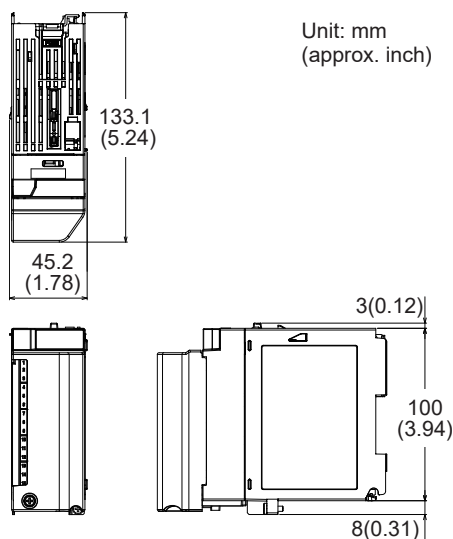

- High speed universal type and high withstand voltage type

**M3 screw terminal**

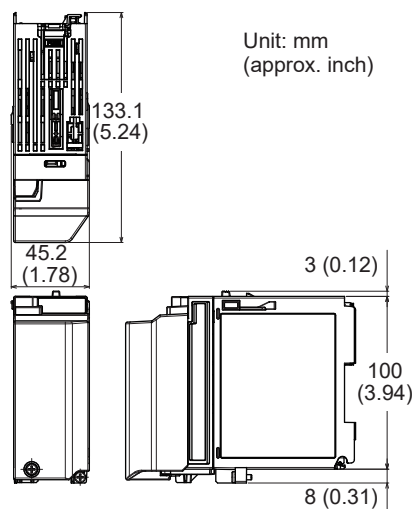

**Clamp terminal**

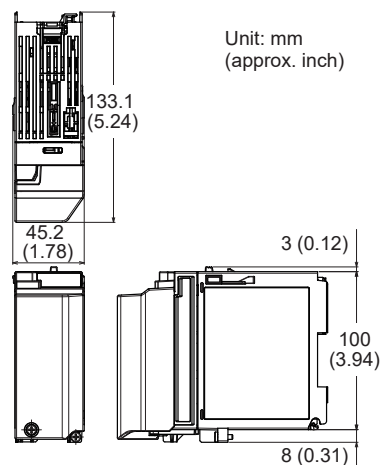

---

## Normal Operating Conditions

For normal operating conditions of this module, please refer to the General Specifications of the device (GX/GP, I/O Base Unit, or GM) that this module is mounted.

GX Specifications: GS 04L51B01-01EN

GP Specifications: GS 04L52B01-01EN

I/O Base Unit (Expandable I/O) Specifications: GS 04L53B00-01EN

GM Specifications: GS 04L55B01-01EN

## Transport and Storage Conditions

- Ambient temperature:  $-25$  to  $70^{\circ}\text{C}$
- Ambient humidity: 5 to 95 %RH (no condensation)
- Vibration: 10 to 60 Hz,  $4.9\text{ m/s}^2$  maximum
- Shock:  $392\text{ m/s}^2$  maximum (in packaged condition)

## Effects of Operating Conditions

Integral time 16.67 ms or more or scan interval 50 ms or more (for the high-speed universal type)

- Influence of ambient temperature: variation against a change of  $10^{\circ}\text{C}$  at an accumulation time of 16.67 ms or more  $\pm$  (0.05% of rdg + 0.05% of range) or below.  
(In case of current (mA) input type,  $\pm$  (0.075% of rdg + 0.05% of range) or below.)  
KpvsAu7Fe, PR20-40:  $\pm$ (0.05% of rdg + 0.1% of range) or below, Cu10 $\Omega$  system or less:  $\pm$ (0.2% of rdg +  $0.1^{\circ}\text{C}$ ) or below  
No reference contact accuracy is guaranteed.
- Influence of power supply voltage variation: Accuracy is satisfied in the range of rated power supply voltage.
- Influence of external magnetic field: Variations against an AC external magnetic field (50/60 Hz, 400 A/m) are  $\pm$ (0.1% of rdg+ 0.1% of range) or below.

## Installation limitations

If you want to use the electromagnetic relay type or high-speed universal type modules on a GM10 single unit, up to eight modules can be installed.

## DIGITAL INPUT MODULE (Model GX90XD or GX/GP main unit options /CRx1)



**GX90XD**

- Application: Remote control input, pulse input\*<sup>1</sup>, etc
  - Number of inputs: 16
  - input type: DI, pulse\*<sup>1</sup>
  - Measurement interval: 100 ms (shortest)
  - Input type: Open collector or Voltage-free contact
  - Insulation type: Photocoupler, Trance (power supply)
  - Contact rating: 12 V DC, 20 mA or more
  - Input resistance: Approx. 1 k $\Omega$
  - Allowable input voltage: +10 V
  - ON/OFF detection
    - Open collector contact input:
      - Voltage in ON state: 0.5 V DC or less
      - Leakage current in OFF state: 0.5 mA or less
    - Voltage-free contact input:
      - Contact resistance in ON state: 200  $\Omega$  or less
      - Contact resistance in OFF state: 50 k $\Omega$  or more
  - Number of common: 2 (1 point/8 channels)
  - Terminal type: M3 screw terminal or Clamp terminal  
(In case of Options /CRx1, a digital input module has M3 screw terminals.)
  - Withstand voltage  
Between the input terminals and the internal circuit: 1500 V AC for one minute
  - Insulation resistance:  
Between the input terminals and the internal circuit: 20 M $\Omega$  or greater at 500 VDC
- [Pulse input specifications]\*<sup>1</sup>
- Counting system: The rising edge of the pulse is counted.
    - Open collector: The signal level at the input terminal changes from high to low.
    - Voltage-free contact: The contact changes from open to close.
  - Max. pulse period:
    - 250Hz (The chattering filter: Off)
    - 125Hz (The chattering filter: On)
  - Min. detection pulse width: Low (close), High (open), both is 2 ms or more
  - Pulse detection period: 1 ms
  - Pulse measuring accuracy:  $\pm 1$  pulse
  - Pulse count interval: measurement interval
  - Filter: The chattering filter can be switched On/Off\*.

\* When the chattering filter is off, connect GX/GP/GM so that it is not affected by the noise.

\*1 MATH function (optional code /MT) is required.

## Safety and EMC Standards

- CSA: CAN/CSA-C22.2 No.61010-1, Overvoltage Category II or I\*<sup>1</sup>, Pollution Degree 2\*<sup>2</sup>
- UL: UL61010-1 (CSA NRTL/C), Overvoltage Category II or I\*<sup>1</sup>, Pollution Degree 2\*<sup>2</sup>
- CE/EMC directive\*<sup>3</sup>: EN61326-1 compliance, Class A Table 2  
EN61000-3-2 compliance  
EN61000-3-3 compliance  
EN55011 Class A Group 1 compliance
- CE/Low voltage directive\*<sup>3</sup>: EN61010-1, Overvoltage Category II or I\*<sup>1</sup>, Pollution degree 2\*<sup>2</sup>
- CE/RoHS directive: "2011/65/EU+(EU)2015/863" (10-Substances) Compliant
- EMC Regulatory Arrangement in Australia and New Zealand (RCM): EN55011 Class A Group 1 compliance
- KC marking: KN11, KN61000-6-2 compliance

\*1 Overvoltage category: Describes a number which defines a transient overvoltage condition. Implies the regulation for impulse withstand voltage.

Applies to electrical equipment which is supplied from the fixed installation like a distribution board. II or I depends on the power supply specification of the main unit.

\*2 Pollution degree 2:

Describes the degree to which a solid, liquid, or gas which deteriorates dielectric strength or surface resistivity is adhering.

"2" applies to normal indoor atmosphere.

Normally, only non-conductive pollution occurs.

\*3 The CE standards for modules represent standards that are met when the module is installed in the main unit.

- WEEE Directive: Compliant

## Construction

- Front panel (terminal): Water and dust-proof, Complies with IEC529-IP20
- Material: Polycarbonate
- Color; Front: Charcoal grey light (Munsell 10B3.6/0.3 equivalent)  
Bezel: Smoke blue (Munsell 4.1PB6.0/4.5 equivalent)
- Dimensions: 45.2 mm(W) x 111 mm(H) x 133.1 mm(D) (D: including terminal cover)
- Weight: Approx. 0.3 kg

## Power Supply

Supply from GX/GP, GX60 expandable I/O, GM90PS power supply module.

- Power consumption: 0.7 W or less

## Isolation

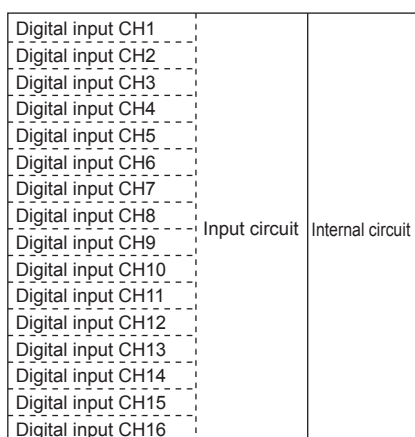

———— Functional insulation

- - - - - Non-isolated

## Terminal arrangements

### M3 screw terminal/Clamp terminal

No.	Symbol	No.	Symbol
21	DI9	11	DI1
22	DI10	12	DI2
23	DI11	13	DI3
24	DI12	14	DI4
25	DI13	15	DI5
26	DI14	16	DI6
27	DI15	17	DI7
28	DI16	18	DI8
29	COM2	19	COM1
30	-	20	-

## External Dimensions

### M3 screw terminal

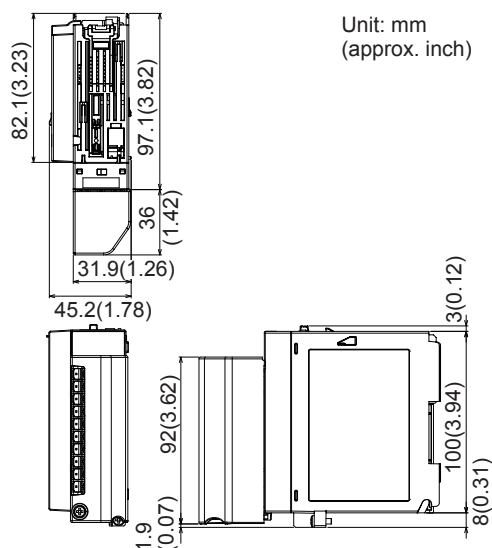

### Clamp terminal

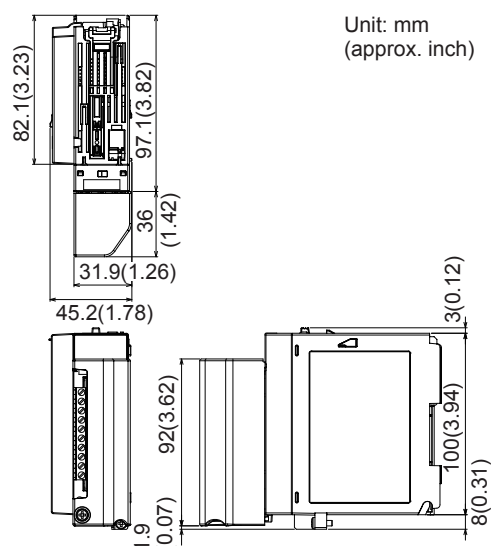

## Normal Operating Conditions

For normal operating conditions of this module, please refer to the General Specifications of the device (GX/GP, I/O Base Unit, or GM) that this module is mounted.

GX Specifications: GS 04L51B01-01EN

GP Specifications: GS 04L52B01-01EN

I/O Base Unit (Expandable I/O): GS 04L53B00-01EN

GM Specifications: GS 04L55B01-01EN

## Transport and Storage Conditions

Same as the GX90XA.

## Installation limitations

When the measurement mode is High speed, a single module, either this module or the GX90WD, can be installed. DI input is fixed to remote mode. Measurement and recording are not possible.



## DIGITAL OUTPUT MODULE (Model GX90YD, or GX/GP main unit options /CR1x, /CR2x, /CR4x)



**GX90YD**

- Application: Alarm output, etc
- Number of outputs: 6
- Output update interval: 100 ms (shortest)
- Output type: Relay contact output, SPDT (NO-C-NC)
- Insulation type: Mechanical
- Rated load voltage: 30 V DC or 250 V AC or less
- Max. load current: 3 A (DC)/3 A (AC), resistance load, each channel
- Min. load voltage/current: 5 V DC/10mA
- Recommended replacement periods of contact: Mechanical 5,000,000 more ON-OFF operations  
Electrical 30,000 more ON-OFF operations (250 V AC 3 A or 30 V DC 3 A, resistance load)
- Number of common: 6
- Terminal type: M3 screw terminal
- Withstand voltage  
Between the output terminals and the internal circuit: 3000 V AC for one minute  
Between the output terminals: 3000 V AC for one minute
- Insulation resistance:  
Between the output terminals and the internal circuit: 20 MΩ or greater at 500 VDC  
Between the output terminals: 20 MΩ or greater at 500 VDC

### Safety and EMC Standards

- CSA:  
CAN/CSA-C22.2 No.61010-1, Overvoltage Category II or I<sup>\*1</sup>, Pollution Degree 2<sup>\*2</sup>
- UL:  
UL61010-1(CSA NRTL/C), Overvoltage Category II or I<sup>\*1</sup>, Pollution Degree 2<sup>\*2</sup>
- CE/EMC directive<sup>\*3</sup>:  
EN61326-1 Class A Table 2(For use in industrial locations) compliance  
EN61000-3-2 compliance  
EN61000-3-3 compliance  
EN55011 Class A Group 1 compliance
- CE/Low voltage directive<sup>\*3</sup>:  
EN61010-1, Overvoltage Category II or I<sup>\*1</sup>, Pollution degree 2<sup>\*2</sup>
- CE/RoHS directive:  
"2011/65/EU+(EU)2015/863" (10-Substances) Compliant
- EMC Regulatory Arrangement in Australia and New Zealand (RCM): EN55011 Class A Group 1 compliance

- KC marking: KN11, KN61000-6-2 compliance
- \*1 Overvoltage category: Describes a number which defines a transient overvoltage condition. Implies the regulation for impulse withstand voltage. Applies to electrical equipment which is supplied from the fixed installation like a distribution board. II or I depends on the power supply specification of the main unit.
- \*2 Pollution degree 2:  
Describes the degree to which a solid, liquid, or gas which deteriorates dielectric strength or surface resistivity is adhering.  
"2" applies to normal indoor atmosphere.  
Normally, only non-conductive pollution occurs.
- \*3 The CE standards for modules represent standards that are met when the module is installed in the main unit.
- WEEE Directive: Compliant

### Construction

- Front panel (terminal): Water and dust-proof, Complies with IEC529-IP20
- Material: Polycarbonate
- Color;  
Front: Charcoal grey light (Munsell 10B3.6/0.3 equivalent)  
Bezel: Smoke blue (Munsell 4.1PB6.0/4.5 equivalent)
- Dimensions: 45.2 mm(W) x 111 mm(H) x 133.1 mm(D) (D: including terminal cover)
- Weight: Approx. 0.3 kg

### Power Supply

- Supply from GX/GP, GX60 expandable I/O, GM90PS power supply module.
- Power consumption: 1.4 W or less

### Isolation

Digital output CH1	Output circuit	Internal circuit
Digital output CH2		
Digital output CH3		
Digital output CH4		
Digital output CH5		
Digital output CH6		

- Functional insulation  
===== Reinforced insulation



## Terminal arrangements

### M3 screw terminal

No.	Symbol	No.	Symbol
21	DO4 N.C.	11	DO1 N.C.
22	DO4 COM	12	DO1 COM
23	DO4 N.O.	13	DO1 N.O.
24	DO5 N.C.	14	DO2 N.C.
25	DO5 COM	15	DO2 COM
26	DO5 N.O.	16	DO2 N.O.
27	DO6 N.C.	17	DO3 N.C.
28	DO6 COM	18	DO3 COM
29	DO6 N.O.	19	DO3 N.O.
30	Not Used	20	Not Used

## External Dimensions

### M3 screw terminal

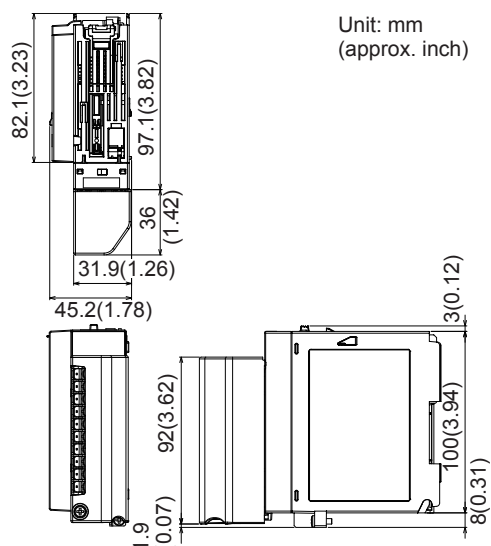

## Normal Operating Conditions

For normal operating conditions of this module, please refer to the General Specifications of the device (GX/GP, I/O Base Unit, or GM) that this module is mounted. However, excluding the shock at energization.

GX Specifications: GS 04L51B01-01EN

GP Specifications: GS 04L52B01-01EN

I/O Base Unit (Expandable I/O): This General Specifications

GM Specifications: GS 04L55B01-01EN

## Transport and Storage Conditions

Same as the GX90XA.

## Installation limitations

When using the GX90WD digital input/output modules and GX90UT PID control modules together, up to a total of 10 modules can be installed.

## DIGITAL INPUT/OUTPUT MODULE (Model GX90WD)



**GX90WD**

Digital input/output module can be used one module on GX/GP main unit, Expandable I/O, GM main unit, and GM sub unit.

### Digital Input Specifications

- Application: Remote control input, pulse input<sup>\*1</sup>, etc
  - Number of inputs: 8
  - input type: DI, pulse<sup>\*1</sup>
  - Measurement interval: 100 ms (shortest)
  - Input type: Open collector or Voltage-free contact
  - Insulation type: Photocoupler, Trance (power supply)
  - Contact rating: Use an external contact of 12 VDC and 20 mA or more.
  - Input resistance: Approx. 2.4 k $\Omega$
  - Allowable input voltage: +10 V
  - ON/OFF detection
  - Open collector contact input:
    - Voltage in ON state: 0.5 V DC or less
    - Leakage current in OFF state: 0.5 mA or less
  - Voltage-free contact input:
    - Contact resistance in ON state: 200  $\Omega$  or less
    - Contact resistance in OFF state: 50 k $\Omega$  or more
  - Number of common: 1 (1 point/8 channels)
  - Terminal type: M3 screw terminal
  - Withstand voltage
    - Between the input terminals and the internal circuit: 1500 V AC for one minute
  - Insulation resistance:
    - Between the input terminals and the internal circuit: 20 M $\Omega$  or greater at 500 VDC
- [Pulse input specifications]<sup>\*1</sup>
- Counting system: The rising edge of the pulse is counted.
    - Open collector: The signal level at the input terminal changes from high to low.
    - Voltage-free contact: The contact changes from open to close.
  - Max. pulse period:
    - 250 Hz (The chattering filter: Off)
    - 125 Hz (The chattering filter: On)
  - Min. detection pulse width: Low (close), High (open), both is 2 ms or more
  - Pulse detection period: 1 ms
  - Pulse measuring accuracy:  $\pm 1$  pulse
  - Pulse count interval: measurement interval
  - Filter: The chattering filter can be switched On/Off<sup>\*</sup>.

<sup>\*</sup> When the chattering filter is off, connect GX/GP/GM so that it is not affected by the noise.

<sup>\*1</sup> MATH function (optional code /MT) is required.

### Digital Output Specifications

- Application: Alarm output, etc
- Number of outputs: 6
- Output update interval: 100 ms (shortest)
- Output type: Relay contact output, SPDT (NO-C-NC)
- Insulation type: Mechanical
- Rated load voltage:
  - Max. 150 VAC when connected to the mains circuit (primary power source).
  - Max. 250 VAC when connected to a circuit (secondary power source) derived from the mains circuit (primary power source) of up to 300V AC, or Max. 30 V DC.
- Maximum voltage between output terminal channels: 250 V AC, Basic insulation
- Max. load current: 2 A (DC)/2 A (AC), resistance load, each channel
- Min. load voltage/current: 5 V DC/10 mA
- Recommended replacement periods of contact:
  - Mechanical 5,000,000 more ON-OFF operations
  - Electrical 30,000 more ON-OFF operations (250 V AC 2 A or 30 V DC 2 A, resistance load)
- Number of common: 6 (All-contact independent)
- Terminal type: M3 screw terminal
- Withstand voltage
  - Between the output terminals and the internal circuit: 2700 V AC for one minute
  - Between the output terminals: 1350 V AC for one minute
- Insulation resistance:
  - Between the output terminals and the internal circuit: 20 M $\Omega$  or greater at 500 VDC
  - Between the output terminals: 20 M $\Omega$  or greater at 500 VDC

### Safety and EMC Standards

- CSA:
  - CAN/CSA-C22.2 No.61010-1, Overvoltage Category II or I<sup>\*1</sup>, Pollution Degree 2<sup>\*2</sup>
- UL:
  - UL61010-1(CSA NRTL/C), Overvoltage Category II or I<sup>\*1</sup>, Pollution Degree 2<sup>\*2</sup>
- CE/EMC directive<sup>\*3</sup>:
  - EN61326-1 Class A Table 2(For use in industrial locations) compliance
  - EN61000-3-2 compliance
  - EN61000-3-3 compliance
  - EN55011 Class A Group 1 compliance
- CE/Low voltage directive<sup>\*3</sup>:
  - EN61010-1, Overvoltage Category II or I<sup>\*1</sup>, Pollution degree 2<sup>\*2</sup>
- CE/RoHS directive:
  - "2011/65/EU+(EU)2015/863" (10-Substances) Compliant
- EMC Regulatory Arrangement in Australia and New Zealand (RCM): EN55011 Class A Group 1 compliance
- KC marking: KN11, KN61000-6-2 compliance

<sup>\*1</sup> Overvoltage category: Describes a number which defines a transient overvoltage condition. Implies the regulation for impulse withstand voltage. Applies to electrical equipment which is supplied from the fixed installation like a distribution board. II or I depends on the power supply specification of the main unit.

- \*2 Pollution degree 2: Describes the degree to which a solid, liquid, or gas which deteriorates dielectric strength or surface resistivity is adhering. "2" applies to normal indoor atmosphere. Normally, only non-conductive pollution occurs.
- \*3 The CE standards for modules represent standards that are met when the module is installed in the main unit.
- WEEE Directive: Compliant

**Construction**

- Front panel (terminal): Water and dust-proof, Complies with IEC529-IP20
- Material: Polycarbonate
- Color;  
Front: Charcoal grey light (Munsell 10B3.6/0.3 equivalent)  
Bezel: Smoke blue (Munsell 4.1PB6.0/4.5 equivalent)
- Dimensions: 45.2 mm(W) x 111 mm(H) x 133.1 mm(D) (D: including terminal cover)
- Weight: Approx. 0.3 kg

**Power Supply**

Supply from GX/GP, GX60 expandable I/O, GM90PS power supply module.

- Power consumption: 1.6 W or less

**Isolation**

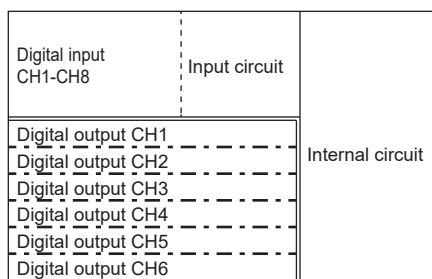

- Functional insulation
- - - - Basic insulation
- ==== Reinforced insulation

Note: Since the insulation specification between output terminal channels is basic insulation, connect so that the potential difference between adjacent channels does not exceed 30 V AC or 60 V DC. If the potential difference from adjacent channel exceeds 30 V AC or 60 V DC, insert an unconnected channel between the two channels.

**Terminal arrangements**

**M3 screw terminal**

No.	Symbol	No.	Symbol	No.	Symbol
301	DI3	201	DI2	101	DI1
302	DI6	202	DI5	102	DI4
303	DI COM	203	DI8	103	DI7
304	Not Used	204	Not Used	104	Not Used
305	DO1 N.O.	205	DO1 COM	105	DO1 N.C.
306	DO2 N.O.	206	DO2 COM	106	DO2 N.C.
307	DO3 N.O.	207	DO2 COM	107	DO3 N.C.
308	DO4 N.O.	208	DO4 COM	108	DO4 N.C.
309	DO5 N.O.	209	DO5 COM	109	DO5 N.C.
310	DO6 N.O.	210	DO6 COM	110	DO6 N.C.

**External Dimensions**

**M3 screw terminal**

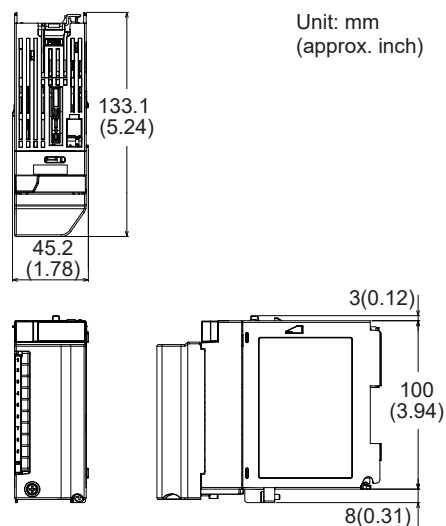

Unit: mm  
(approx. inch)

---

### Normal Operating Conditions

For normal operating conditions of this module, please refer to the General Specifications of the device (GX/GP, I/O Base Unit, or GM) that this module is mounted. However, excluding the shock at energization.

GX Specifications: GS 04L51B01-01EN

GP Specifications: GS 04L52B01-01EN

I/O Base Unit (Expandable I/O): This General Specifications

GM Specifications: GS 04L55B01-01EN

### Transport and Storage Conditions

Same as the GX90XA.

### Installation limitations

- A single module can be installed in each unit.
- When using the GX90YD digital output modules and GX90UT PID control modules together, up to a total of 10 modules can be installed.
- When the measurement mode is High speed, a single module, either this module or the GX90XD, can be installed. DI input is fixed to remote mode. Measurement and recording are not possible.  
The DO function cannot be used.

## PULSE INPUT MODULE (Model GX90XP)



**GX90XP**

- Application: Pulse input (flow sum and the like)
- Number of inputs: 10
- Measurement interval: 100 ms (shortest)
- Input type: Contact (open collector, voltage-free contact), level (5 V logic)
- Input format: Pulled up to approx. 5 V through 5 k $\Omega$ , common potential shared within the same module
- Input range: Up to 20 kHz\*
  - \* 30 Hz when the chattering filter is in use (On)
- Minimum detection pulse width: 25  $\mu$ s\*
  - \* 15 ms when the chattering filter is in use (On)
- Measurement accuracy: Count  $\pm$  1 pulse  
For integration computation \*, the following accuracies are added.  
Computation start: +1 scan interval  
Computation stop: -1 scan interval  
\* Integration requires the math function (/MT option).
- Chattering filter: Removes chattering up to 5 ms (can be turned on/off on each channel)  
\* When the chattering filter is off, connect GX/GP/GM so that it is not affected by the noise.
- Input threshold level:
  - Contact (open collector, voltage-free contact):  
Counted when a change from 100 k $\Omega$  or higher to 200  $\Omega$  or lower is detected
  - Level (5 V logic):  
Counted when a change from 1 V or lower to 3 V or higher is detected
- Hysteresis width: Approx. 0.2 V
- Contact, transistor rating:
  - Contact: 15 V DC or higher and 30 mA or higher rating. Minimum applicable load current 1 mA or less.
  - Transistor: With the following ratings: Vce > 15 V DC, Ic > 30 mA
- Allowable input voltage:  $\pm$ 10 V DC
- Insulation type: Photocoupler isolation, transformer isolation
- Terminal type: M3 screw terminal or clamp terminal
- Withstand voltage:
  - Between the input terminals and the internal circuit: 1500 V AC for 1 minute
- Insulation resistance:
  - Between the input terminals and the internal circuit: 20 M $\Omega$  or greater at 500 V DC

## Safety and EMC Standards

- CSA:  
CAN/CSA-C22.2 No.61010-1, Overvoltage Category II or I<sup>\*1</sup>, Pollution Degree 2<sup>\*2</sup>
- UL:  
UL61010-1(CSA NRTL/C), Overvoltage Category II or I<sup>\*1</sup>, Pollution Degree 2<sup>\*2</sup>
- CE/EMC directive<sup>\*3</sup>:  
EN61326-1 Class A Table 2(For use in industrial locations) compliance  
EN61000-3-2 compliance  
EN61000-3-3 compliance  
EN55011 Class A Group 1 compliance
- CE/Low voltage directive<sup>\*3</sup>:  
EN61010-1, Overvoltage Category II or I<sup>\*1</sup>, Pollution degree 2<sup>\*2</sup>  
Measurement category II<sup>\*3</sup>
- CE/RoHS directive:  
"2011/65/EU+(EU)2015/863" (10-Substances) Compliant
- EMC Regulatory Arrangement in Australia and New Zealand (RCM): EN55011 Class A Group 1 compliance
- KC marking: KN11, KN61000-6-2 compliance
- \*1 Overvoltage category: Describes a number which defines a transient overvoltage condition. Implies the regulation for impulse withstand voltage. Applies to electrical equipment which is supplied from the fixed installation like a distribution board. II or I depends on the power supply specification of the main unit.
- \*2 Pollution degree 2:  
Describes the degree to which a solid, liquid, or gas which deteriorates dielectric strength or surface resistivity is adhering.  
"2" applies to normal indoor atmosphere.  
Normally, only non-conductive pollution occurs.
- \*3 The CE standards for modules represent standards that are met when the module is installed in the main unit.
- WEEE Directive: Compliant

## Construction

- Front panel (terminal): Water and dust-proof, Complies with IEC529-IP20
- Material: Polycarbonate
- Color;  
Front: Charcoal grey light (Munsell 10B3.6/0.3 equivalent)  
Bezel: Smoke blue (Munsell 4.1PB6.0/4.5 equivalent)
- Dimensions: 45.2 mm(W) x 111 mm(H) x 133.1 mm(D) (D: including terminal cover)
- Weight: Approx. 0.3 kg

## Power Supply

- Supply from GX/GP, GX60 expandable I/O, GM90PS power supply module.
- Power consumption: 0.9 W or less

## Isolation

Pulse input CH1	Input circuit	Internal circuit
Pulse input CH2		
Pulse input CH3		
Pulse input CH4		
Pulse input CH5		
Pulse input CH6		
Pulse input CH7		
Pulse input CH8		
Pulse input CH9		
Pulse input CH10		

———— Functional insulation

----- Non-isolated

## Terminal arrangements

### M3 screw terminal/Clamp terminal

No.	Symbol	No.	Symbol
21	CH6 +	11	CH1 +
22	CH6 -	12	CH1 -
23	CH7 +	13	CH2 +
24	CH7 -	14	CH2 -
25	CH8 +	15	CH3 +
26	CH8 -	16	CH3 -
27	CH9 +	17	CH4 +
28	CH9 -	18	CH4 -
29	CH10 +	19	CH5 +
30	CH10 -	20	CH5 -

\* Negative terminal (common) potential shared

## External Dimensions

### M3 screw terminal

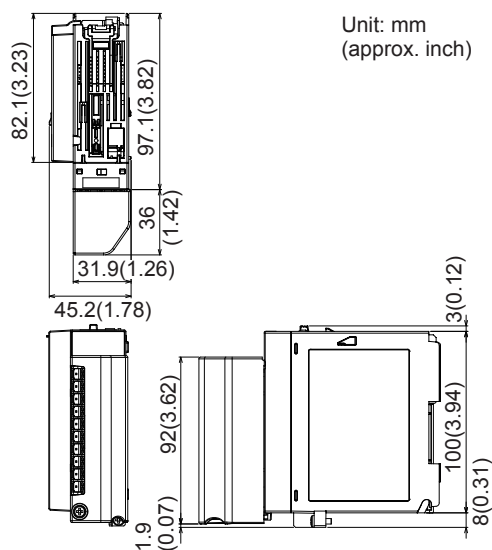

### Clamp terminal

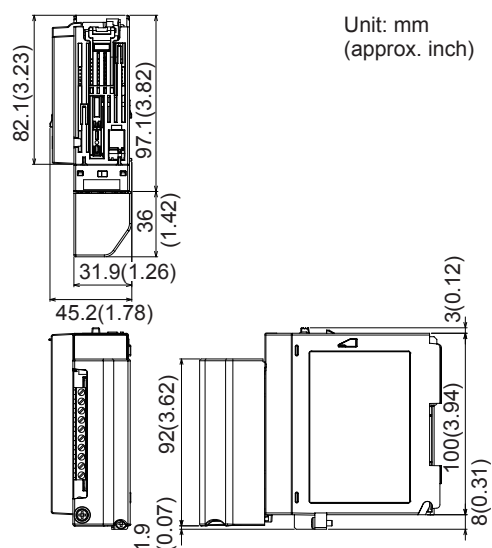

## Normal Operating Conditions

For normal operating conditions of this module, please refer to the General Specifications of the device (GX/GP, I/O Base Unit, or GM) that this module is mounted.

GX Specifications: GS 04L51B01-01EN

GP Specifications: GS 04L52B01-01EN

I/O Base Unit (Expandable I/O):

GS 04L53B00-01EN

GM Specifications: GS 04L55B01-01EN

## Transport and Storage Conditions

Same as the GX90XA.

## ANALOG OUTPUT MODULE (Model GX90YA)



**GX90YA**

- Application: Retransmission output, Manual output
- Number of outputs: 4 (isolated between channels)
- Output type: 4 to 20mA or 0 to 20mA
- Output update interval: 100 ms (shortest)
- Load resistance: 600Ω or less
- Output range: 0 to 22mA
- Output accuracy:  $\pm 0.1\%$  of F.S. (1mA or more) (F.S.=20mA)
- Resolution: 0.002%
- Operating temperature range:  $-20$  to  $50^{\circ}\text{C}$
- Terminal type: M3 screw terminal or Clamp terminal
- Withstand voltage  
Between the output terminals and the internal circuit: 1500 V AC for one minute  
Between the output terminals and the output terminals: 500 V AC for one minute
- Insulation resistance:  
Between the output terminals and the internal circuit: 20 MΩ or greater at 500 VDC  
Between the output terminals and the output terminal: 20 MΩ or greater at 500 VDC

### Safety and EMC Standards

- CSA:  
CAN/CSA-C22.2 No.61010-1, Overvoltage Category II or I<sup>\*1</sup>, Pollution Degree 2<sup>\*2</sup>
- UL:  
UL61010-1(CSA NRTL/C), Overvoltage Category II or I<sup>\*1</sup>, Pollution Degree 2<sup>\*2</sup>
- CE/EMC directive<sup>\*3</sup>:  
EN61326-1 Class A Table 2(For use in industrial locations) compliance  
EN61000-3-2 compliance  
EN61000-3-3 compliance  
EN55011 Class A Group 1 compliance
- CE/Low voltage directive<sup>\*3</sup>  
EN61010-1, Overvoltage Category II or I<sup>\*1</sup>, Pollution degree 2<sup>\*2</sup>
- CE/RoHS directive:  
"2011/65/EU+(EU)2015/863" (10-Substances) Compliant
- EMC Regulatory Arrangement in Australia and New Zealand (RCM): EN55011 Class A Group 1 compliance
- KC marking: KN11, KN61000-6-2 compliance

- \*1 Overvoltage category: Describes a number which defines a transient overvoltage condition. Implies the regulation for impulse withstand voltage. Applies to electrical equipment which is supplied from the fixed installation like a distribution board. II or I depends on the power supply specification of the main unit.
  - \*2 Pollution degree 2:  
Describes the degree to which a solid, liquid, or gas which deteriorates dielectric strength or surface resistivity is adhering.  
"2" applies to normal indoor atmosphere. Normally, only non-conductive pollution occurs.
  - \*3 The CE standards for modules represent standards that are met when the module is installed in the main unit.
- WEEE Directive: Compliant

### Construction

- Front panel (terminal): Water and dust-proof, Complies with IEC529-IP20
- Material: Polycarbonate
- Color;  
Front: Charcoal grey light (Munsell 10B3.6/0.3 equivalent)  
Bezel: Smoke blue (Munsell 4.1PB6.0/4.5 equivalent)
- Dimensions: 45.2 mm(W) x 111 mm(H) x 133.1mm(D)  
(D: including terminal cover)
- Weight: Approx. 0.2 kg

### Power Supply

Supply from GX/GP, GX60 expandable I/O, GM90PS power supply module.

- Power consumption: 3 W or less

### Isolation

Analog output CH1	Internal circuit
Analog output CH2	
Analog output CH3	
Analog output CH4	

———— Functional insulation

### Terminal arrangements

#### M3 screw terminal/Clamp terminal

Term. No.	Symbol
11	CH1 +
12	-
13	CH2 +
14	-
15	CH3 +
16	-
17	CH4 +
18	-
19	Not Used
20	Not Used



## D/A Calibration Value

Two types of D/A calibration values (factory shipment setting and user setting) can be saved. If the user setting is not proper, it can be restored to the calibration value at factory shipment.

## External Dimensions

### M3 screw terminal/Clamp terminal

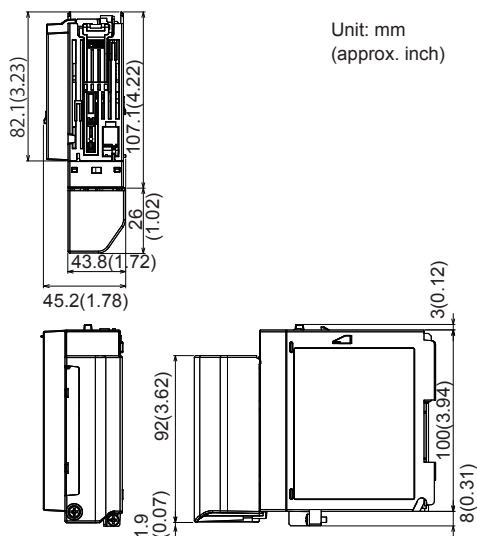

## Normal Operating Conditions

For normal operating conditions of this module, please refer to the General Specifications of the device (GX/GP, I/O Base Unit, or GM) that this module is mounted.

GX Specifications: GS 04L51B01-01EN

GP Specifications: GS 04L52B01-01EN

I/O Base Unit (Expandable I/O): GS 04L53B00-01EN

GM Specifications: GS 04L55B01-01EN

## Transport and Storage Conditions

Same as the GX90XA.

## Effects of Operating Conditions

- Influence of power supply voltage variation: Accuracy is satisfied in the range of rated power supply voltage.
- temperature influence:  $\pm 200$  ppm of F.S./ $^{\circ}\text{C}$  or less

## Installation Conditions

- Installation limitations by unit
  - GX10/GP10: Up to 1 module
  - GX20/GP20: Up to 2 module
  - GM10/GX60: Up to 2 modules per unit
- System limitations
  - GX10/GX20-1: Up to 10 module
  - GX20-2: Up to 12 module
- If you want to use this module simultaneously with the GX90XA-04-H0 (high-speed universal type) module, the following limitation applies to the number of modules (including expansion modules) that can be used.

Model	Number of modules
GP10 (12 V DC)	Up to two modules total
GX20/GP20	Up to nine modules total
GX60	No limit
GM10 Single unit	Up to seven modules total
GM10 Multi unit (main unit/ Sub unit)	No limit

- Performing thermocouple measurement on a slot left of this module (above, below, left, and right for the GX20/GP20) may increase RJC errors on that module.



## ■ MODEL AND SUFFIX CODES

Analog input module, Digital I/O module (sold separately):

### MODEL and SUFFIX Code (GX90XA)

Model	Suffix Code				Description
<b>GX90XA</b>					Analog Input Module
Number of channels	<b>-04</b>				4 channels (Type -H0 only)
	<b>-06</b>				6 channels (Type -R1 only)
	<b>-10</b>				10 channels (Type -C1, -L1, -U2, -T1, -V1)
Type	<b>-C1</b>				Current, scanner type (isolated between channels)
	<b>-L1</b>				DCV/TC/DI, low withstand voltage scanner type (isolated between channels)
	<b>-U2</b>				Universal, Solid state relay scanner type (3-wire RTD b-terminal common)
	<b>-T1</b>				DCV/TC/DI, Electromagnetic relay scanner type (isolated between channels)
	<b>-H0</b>				High-speed universal, individual A/D type (isolated between channels)
	<b>-R1</b>				4-wire RTD/resistance, scanner type (isolated between channels)
	<b>-V1</b>				DCV/TC/DI, high withstand voltage scanner type (isolated between channels)
-		<b>N</b>			Always N
Terminal form			<b>-3</b>		Screw terminal (M3)
			<b>-C</b>		Clamp terminal
Area			<b>N</b>		General

### MODEL and SUFFIX Code (GX90XD)

Model	Suffix Code				Description
<b>GX90XD</b>					Digital Input Module*
Number of channels	<b>-16</b>				16 channels
Type	<b>-11</b>				Open collector/Non-voltage, contact (shared common), Rated 5 VDC
-		<b>N</b>			Always N
Terminal form			<b>-3</b>		Screw terminal (M3)
			<b>-C</b>		Clamp terminal
Area			<b>N</b>		General

\* If you want to integrate pulse input, a math function (/MT option) is required in the GX/GP/GM main unit.

### MODEL and SUFFIX Code (GX90YD)

Model	Suffix Code				Description
<b>GX90YD</b>					Digital Output Module
Number of channels	<b>-06</b>				6 channels
Type	<b>-11</b>				Relay, SPDT(NO-C-NC)
-		<b>N</b>			Always N
Terminal form			<b>-3</b>		Screw terminal (M3)
Area			<b>N</b>		General

### MODEL and SUFFIX Code (GX90WD)

Model	Suffix Code				Description
<b>GX90WD</b>					Digital Input/Output Module*
Number of channels	<b>-0806</b>				8 channel DIs, 6 channel DOs
Type	<b>-01</b>				Open collector/non-voltage contact (shared common), rated 5 VDC; Relay, SPDT (NO-C-NC)
-		<b>N</b>			Always N
Terminal form			<b>-3</b>		Screw terminal (M3)
Area			<b>N</b>		General

\* If you want to integrate pulse input, a math function (/MT option) is required in the GX/GP/GM main unit.

**MODEL and SUFFIX Code (GX90XP)**

Model	Suffix Code				Description
<b>GX90XP</b>					Pulse Input Module*
Number of channels	<b>-10</b>				10 channels
Type		<b>-11</b>			DC voltage/open collector/non-voltage contact (shared common), rated 5 VDC
-			<b>N</b>		Always N
Terminal form				<b>-3</b>	Screw terminal (M3)
				<b>-C</b>	Clamp terminal
Area				<b>N</b>	General

\* If you want to integrate pulse input, a math function (/MT option) is required in the GX/GP/GM main unit.

**MODEL and SUFFIX Code (GX90YA)**

Model	Suffix Code				Description
<b>GX90YA</b>					Analog Output Module
Number of channels	<b>-04</b>				4 channels
Type		<b>-C1</b>			Current (isolated between channels)
-			<b>N</b>		Always N
Terminal form				<b>-3</b>	Screw terminal (M3)
				<b>-C</b>	Clamp terminal
Area				<b>N</b>	General

**■ Optional Accessories (Sold Separately)**

Product	Model/part no.
Shunt resistor for M3 terminal (250 Ω ± 0.1 %)	415940
Shunt resistor for M3 terminal (100 Ω ± 0.1 %)	415941
Shunt resistor for M3 terminal (10 Ω ± 0.1 %)	415942
Shunt resistor for Clamp terminal (250 Ω ± 0.1 %)	438920
Shunt resistor for Clamp terminal (100 Ω ± 0.1 %)	438921
Shunt resistor for Clamp terminal (10 Ω ± 0.1 %)	438922

**Calibration certificate (sold separately)**

When ordering the GX10/GX20/GP10/GP20 with options (analog input), the calibration certificate for the modules is included in and shipped with the calibration certificate of the main unit.

When ordering an analog input module, each module gets its own calibration certificate (one certificate per module).

**Test certificate (QIC, sold separately)**

When ordering the GX10/GX20/GP10/GP20 with options (analog/digital I/O), the QIC for each module is included in and shipped with the QIC of the main unit.

When ordering analog input modules and digital I/O modules, each module gets its own QIC (one QIC per module).

**User's Manual**

Product user's manuals can be downloaded or viewed at the following URL. To view the user's manual, you need to use Adobe Reader 7 or later by Adobe Systems.

**URL: [www.smartdacplus.com/manual/en/](http://www.smartdacplus.com/manual/en/)**

**Product Purchase Specifications**

- The GX10/GX20/GP10/GP20 is composed of the main unit, I/O modules, the expandable I/O, and the expansion module.  
There are two ways to purchase I/O modules.  
One way is to purchase them individually by specifying models GX90XA, GX90XD, GX90YD, GX90WD, GX90XP, and GX90YA, .  
The other way is to purchase them as an option (/UCxx or /USxx). Purchasing them as an option is convenient, but this places limitations on the number of analog inputs that you can obtain.  
If you want to use more than 51 channels, please purchase the I/O modules individually.
- The GM is composed of the data acquisition module, the power supply module, the module base, the I/O module, and the expansion module.  
Please purchase the modules and module base individually.

---

**Trademarks**

The TCP/IP software used in this product and the document for that TCP/IP software are based in part on BSD networking software, Release 1 licensed from The Regents of the University of California.

- SMARTDAC+ and SMARTDACPLUS are registered trademarks or trademarks of Yokogawa Electric Corporation.
- Microsoft, MS and Windows are registered trademarks or trademarks of Microsoft Corporation USA.
- Pentium are registered trademarks of Intel Corporation.
- Modbus is a registered trademark of AEG Schneider.
- Other company names and product names appearing in this document are registered trademarks or trademarks of their respective holders.

Blank

# General Specifications

## GX90UT PID Control Module **SMARTDAC+**

GX10/GX20/GP10/GP20 Paperless Recorder  
Data Acquisition System GM

GS 04L53B01-31EN

Loop Control Function, Program Control Function (/PG Option)

### Overview

The GX90UT is a PID control module that connects to the GX/GP, expandable I/O units, and GM main units and sub units.

- The GX90UT PID Control Module can perform PID control on up to two loops. It is equipped with two control inputs, two control outputs, eight digital inputs, and eight digital outputs. In addition to single loop control, cascade control and loop control with PV switching are possible. For the control output, you can select current output or voltage pulse for each loop.
- Installing the PID Control Module in the GX/GP/GM enables PID control of up to 20 loops/system (up to 6 loops/system for the GX10/GP10/GX20-1/GP20-1/GM10-1). In addition to control loop monitoring and the control group screen for convenient operation, adjustment using the tuning screen is available.
- Adding the /PG option to the GX/GP/GM main unit allows 99 patterns and 99 segments (1 pattern) of program patterns to be stored in the main unit. Further, up to 32 time events and 32 PV events can be set for each segment.
- The GX90UT control data can be acquired and recorded in the GX/GP/GM main unit.

### PID Control Module Specifications (Model: GX90UT)

#### Use

Controlling temperature, flow rate, pressure, etc.

#### Analog Input

- Measurement types: DC voltage (DCV), standard signal, type (TC), resistance temperature detector (RTD), DI (LEVEL, no-voltage contact), DC current (when external shunt resistor is connected)
- Number of measurement points: 2
- Scan period: Same as the control period
- Input format: Floating unbalanced input, isolation between channels
- Measuring range/accuracy:  
See the table in "Measuring Range/Accuracy" (page 3).
- Burnout detection: Upscale, downscale, and off can be specified (for each channel).  
Detectable inputs: Thermocouple, resistance temperature detector, standard signal  
Detection condition:  
Thermocouple: Detection current: approx. 100 nA, superposed electric current system  
RTD: Detection current: approx. 100 nA, superposed electric current system



GX90UT

Standard signal: Normal: within measurement range  
Disconnection: based on the burnout criteria setting

The criteria is set as a percentage of the specified span width.

Lower limit: -20.0 to -5.0%

Upper limit: 105 to 120%

- External input resistance:  
DC voltage, thermocouple: 2 k $\Omega$  or less  
RTD: 10  $\Omega$  or less per line (the same resistance for all three lines)
- Input bias current:  $\pm 10$  nA or less (except when burnout detection is set)
- Measurement current (RTD): Approx. 1 mA, approx. 1.6 mA
- Input resistance:  
10 M $\Omega$  or more for thermocouple/DC voltage (1 V range or lower)  
About 1 M $\Omega$  for DC voltage (2 V range or higher)/standard signal
- Allowable signal source resistance  
2 k $\Omega$  or less for thermocouple/DC voltage (1 V range or less)
- Effect of signal source resistance:  
 $\pm 10$   $\mu$ V/1 k $\Omega$  or less for thermocouple/DC voltage (1 V range or less)  
 $\pm 0.15\%$ /1 k $\Omega$  or less for DC voltage (2 V range or higher)/standard signal
- Effect of wiring resistance:  
Fluctuation per 10  $\Omega$  change per line (the same resistance for all three lines)  
RTD (100  $\Omega$  type or higher):  $\pm 0.1^\circ\text{C}/10$   $\Omega$   
RTD (50  $\Omega$  type or lower):  $\pm 1^\circ\text{C}/10$   $\Omega$
- Allowable input voltage:  
Thermocouple, DC voltage (1 V range or lower), RTD, DI(contact input):  $\pm 10$  VDC  
DC voltage (2 V range or higher), DI (level):  $\pm 60$  VDC
- Normal-mode rejection ratio: 40 dB or more
- Common mode rejection ratio: 120 dB or more

- Normal mode voltage:
  - Thermocouple, DC voltage, DI (voltage): 1.2 times the range rating or less
  - Standard signal 0.4-2 V range: 2.4 V
  - Standard signal 1-5 V range: 6 V
  - RTD 100  $\Omega$  type or higher: 50 mV peak
  - RTD 50  $\Omega$  type or lower: 10 mV peak
- Common mode voltage:
  - 30 VACrms or  $\pm 60$  VDC
  - Maximum common mode noise voltage: 250 VACrms
- Common mode voltage between channels:
  - 30 VACrms or  $\pm 60$  VDC
  - Maximum common mode noise voltage: 250 VACrms
- Reference junction compensation accuracy:
  - When measuring temperature greater than or equal to 0  $^{\circ}\text{C}$ , using a power supply frequency noise reduction filter, and when the temperature of the input terminal is balanced
  - Type K, E, J, T, N, XK GOST:
    - $\pm 0.5^{\circ}\text{C}$  ( $23^{\circ}\text{C} \pm 2^{\circ}\text{C}$ )
    - $\pm 0.7^{\circ}\text{C}$  (0 to  $50^{\circ}\text{C}$ )
    - $\pm 1.0^{\circ}\text{C}$  ( $-20$  to  $60^{\circ}\text{C}$ )
  - Type R, S, W, L, U, WRe3-25, PLATINEL II, NiNiMo, W/WRe26, N (AWG14):
    - $\pm 1.0^{\circ}\text{C}$  ( $23^{\circ}\text{C} \pm 2^{\circ}\text{C}$ )
    - $\pm 1.4^{\circ}\text{C}$  (0 to  $50^{\circ}\text{C}$ )
    - $\pm 2.0^{\circ}\text{C}$  ( $-20$  to  $60^{\circ}\text{C}$ )
  - Type KpvsAu7Fe:
    - $\pm 1.0$  K ( $23^{\circ}\text{C} \pm 2^{\circ}\text{C}$ )
    - $\pm 1.4$  K (0 to  $50^{\circ}\text{C}$ )
    - $\pm 2.0$  K ( $-20$  to  $60^{\circ}\text{C}$ )
  - Type B, PR20-40: internal RJC fixed at  $0^{\circ}\text{C}$
- Calibration correction function:
  - Mode: Linearizer approximation, linearizer bias (number of correction points: 12), correction factor
- First-order lag input filter: on/off switchable (for each channel)
  - Time constant: 1 to 120 s
- Reference junction compensation:
  - internal/external switchable (for each channel)
- Input calculation: off, linear scaling, square root calculation (for each channel)\*DC voltage/standard signal
- Bias function: Bias to add to input values can be specified (for each channel).

Measuring Range/Accuracy<sup>1</sup>

Input type	Range	Measurement range	Measurement accuracy (digital display)	Digital display highest resolution
DC voltage	20 mV	-20.000 to 20.000 mV	±(0.05% of rdg+12μV)	1 μV
	60 mV	-60.00 to 60.00 mV	±(0.05% of rdg+0.02 mV)	10 μV
	200 mV	-200.00 to 200.00 mV	±(0.05% of rdg+0.03 mV)	10 μV
	1 V	-1.0000 to 1.0000 V	±(0.05% of rdg+0.2 mV)	100 μV
	2 V	-2.0000 to 2.0000 V	±(0.05% of rdg+1.2 mV)	100 μV
	6 V	-6.000 to 6.000 V	±(0.05% of rdg+2 mV)	1 mV
	20 V	-20.000 to 20.000 V	±(0.05% of rdg+3 mV)	1 mV
	50 V	-50.00 to 50.00 V	±(0.05% of rdg+0.02 V)	10 mV
Standard signal	0.4-2V	0.3200 to 2.0800 V	±(0.05% of rdg+1.2 mV)	100 μV
	1-5V	0.800 to 5.200 V	±(0.05% of rdg+2 mV)	1 mV
Thermocouple (does not include reference junction compensation accuracy)	R <sup>2</sup>	0.0 to 1760.0°C	±(0.05% of rdg+1.0°C)	0.1°C
	S <sup>2</sup>	0.0 to 1760.0°C	Except R and S; 0.0 to 800.0°C: ±1.4°C	
	B <sup>2</sup>	0.0 to 1820.0°C	B; 400.0 to 800.0°C: ±3.0°C Accuracy not guaranteed for temperatures less than 400.0°C	
	K <sup>2</sup>	-270.0 to 1370.0°C	±(0.05% of rdg+0.7°C)	0.1°C
		-200.0 to 500.0°C	Except -200.0 to 0.0°C: ±(0.2% of rdg + 0.7°C) Accuracy not guaranteed for temperatures less than -200.0°C	
	E <sup>2</sup>	-270.0 to 800.0°C	±(0.05% of rdg+0.5°C)	0.1°C
	J <sup>2</sup>	-200.0 to 1100.0°C	Except -200.0 to 0.0°C: ±(0.2% of rdg + 0.5°C) Accuracy not guaranteed for temperatures less than -200.0°C	0.1°C
	T <sup>2</sup>	-270.0 to 400.0°C	±(0.05% of rdg+0.5°C) Except -200.0 to 0.0°C: ±(0.2% of rdg + 0.5°C) Accuracy not guaranteed for temperatures less than -200.0°C	0.1°C
	N <sup>2</sup>	-270.0 to 1300.0°C	±(0.05% of rdg+0.7°C) Except -200.0 to 0.0°C: ±(0.5% of rdg + 0.7°C) Accuracy not guaranteed for temperatures less than -200.0°C	0.1°C
	W <sup>3</sup>	0.0 to 2315.0°C	±(0.05% of rdg+1.0°C) 1000.0 °C or more: ±0.15% of rdg	0.1°C
L <sup>4</sup>	-200.0 to 900.0°C	±(0.05% of rdg+0.5°C) Less than 0.0°C: ±(0.25% of rdg + 0.5°C)	0.1°C	
U <sup>4</sup>	-200.0 to 400.0°C	±(0.05% of rdg+0.5°C) Less than 0.0°C: ±(0.5% of rdg + 0.5°C)	0.1°C	
Thermocouple (does not include reference junction compensation accuracy)	WRe3-25 <sup>5</sup>	0.0 to 2320.0°C	±(0.05% of rdg+2.0°C) 2000.0 °C or more: ±0.15% of rdg	0.1°C
	KpvsAu7Fe <sup>6</sup>	0.0 to 300.0 K	±(0.05% of rdg+2.0 K)	0.1 K
	PLATINEL II <sup>6</sup>	0.0 to 1395.0°C	±(0.05% of rdg+1.0°C)	0.1°C
	PR20-40 <sup>7</sup>	0.0 to 1900.0°C	±(0.05% of rdg+5.5°C) Accuracy not guaranteed for temperatures less than 800.0°C	0.1°C
	NiNiMo <sup>6</sup>	0.0 to 1310.0°C	±(0.05% of rdg+0.7°C)	0.1°C
	W/WRe26 <sup>8</sup>	0.0 to 2320.0°C	±(0.05% of rdg+2.0°C) Accuracy not guaranteed for temperatures less than 300.0°C	0.1°C
	N(AWG14) <sup>9</sup>	0.0 to 1300.0°C	±(0.05% of rdg+0.7°C)	0.1°C
XK GOST <sup>10</sup>	-200.0 to 600.0°C	±(0.05% of rdg+0.5°C) Less than 0.0°C: ±(0.2% of rdg + 0.5°C)	0.1°C	
RTD (measurement current 1 mA)	Pt100 <sup>11</sup>	-200.0 to 850.0°C	±(0.05% of rdg+0.3°C)	0.1°C
		-150.00 to 150.00°C		0.01°C
	JPt100 <sup>11</sup>	-200.0 to 550.0°C	±(0.05% of rdg+0.3°C)	0.1°C
		-150.00 to 150.00°C		0.01°C
	Cu100 at 0°C α=0.00425	-50.0 to 150.0°C	±(0.05% of rdg+0.3°C)	0.1°C
	Cu25 at 0°C α=0.00425	-200.0 to 300.0°C	±(0.1% of rdg+0.8°C)	0.1°C
	Cu53 at 0°C α=0.00426035	-50.0 to 150.0°C	±(0.05% of rdg+0.6°C)	0.1°C
	J263B <sup>17</sup>	0.0 to 300.0 K	±0.4 K Less than 40.0 K: ±0.8 K	0.1 K
	Pt25 <sup>18</sup>	-200.0 to 550.0°C	±(0.1% of rdg+0.8°C)	0.1°C
	Ni100 (SAMA)	-200.0 to 250.0°C	±(0.05% of rdg+0.3°C)	0.1°C
	Ni100 (DIN) <sup>12</sup>	-60.0 to 180.0°C		
	Ni120 <sup>13</sup>	-70.0 to 200.0°C		
	Pt50 <sup>14</sup>	-200.0 to 550.0°C	±(0.05% of rdg+0.6°C)	0.1°C
	Pt200 WEED	-100.0 to 250.0°C	±(0.05% of rdg+1.0°C)	0.1°C
	Cu100 GOST <sup>15</sup>	-200.0 to 200.0°C	±(0.05% of rdg+0.3°C)	0.1°C
Pt46 GOST <sup>16</sup>	-200.0 to 550.0°C	±(0.05% of rdg+0.6°C)	0.1°C	
Pt100 GOST <sup>15</sup>	-200.0 to 600.0°C	±(0.05% of rdg+0.3°C)	0.1°C	

rdg: reading

Continued

Input type	Range	Measurement range	Measurement accuracy (digital display)	Digital display highest resolution
RTD (measurement current 1.6mA)	Cu10 GE	-200.0 to 300.0°C	±(0.1% of rdg+2.0°C)	0.1°C
	Cu10 L&N	-200.0 to 300.0°C	Guaranteed accuracy range	
	Cu10 WEED	-200.0 to 300.0°C	Cu10 GE: -70.0 to 170.0°C	
	Cu10 BAILEY	-200.0 to 300.0°C	Cu10 L&N: -75.0 to 150.0°C	
	Cu10 at 20°C α=0.00392	-200.0 to 300.0°C	Cu10 WEED: -200.0 to 260.0°C	
	Cu10 at 20°C α=0.00393	-200.0 to 300.0°C	Other than above: -200.0 to 300.0°C	
	Cu10 GOST <sup>19</sup>	-200.0 to 200.0°C	±(0.1% of rdg+2.0°C)	0.1°C
Cu50 GOST <sup>16</sup>	-200.0 to 200.0°C	±(0.05% of rdg+0.6°C)	0.1°C	
DI	Level		Threshold level (V <sub>th</sub> = 2.4 V) accuracy ± 0.1 V	-
	Contact <sup>20</sup>		100 Ω or less: 1 (ON), 10 kΩ or more: 0 (OFF)	-

rdg: reading

1 Under standard operating conditions: 23±2°C, 55±10% RH, supply voltage 90–132, 180–264 V AC, supply frequency within 50/60 Hz ±1%, warm-up of 30 minutes or more, no vibrations or other hindrances to performance.

2 R, S, B, K, E, J, T, N: IEC 60584-1, DIN EN 60584, JIS1602

3 W: W-5%Re/W-26%Re(Hoskins Mfg.Co.) ASTM E988-96

4 L: Fe-CuNi, DIN43710, U: Cu-CuNi, DIN43710

5 WRe3-25: W-3%Re/W-25%Re(Hoskins Mfg.Co.) ASTM E988-96

6 KpvsAu7Fe, PLATINEL II, NiNiMo: ASTM E1751

7 PR20-40: PtRh20%-PtRh40%(Johnson Matthey Plc) ASTM E1751

8 W/WRe26: W/W-26%Re(Hoskins Mfg.Co.) ASTM E1751

9 N(AWG14): NBS

10 XK GOST: Type L (GOST R 8.525-2001)

11 Pt100: JIS C 1604, IEC 60751, DIN EN 60751

JPt100: JIS C1604, JIS C1606

12 Ni100 (DIN): DIN 43760

13 Ni120: McGRAW EDISON COMPANY

14 Pt50: JIS C1604, JIS C1606

15 Cu100 GOST, Pt100 GOST: GOST 6651-2009

16 Cu50 GOST, Pt46 GOST: GOST 6651-94

17 J263B: YOKOGAWA J263\*B

18 Pt25: 1/4 the JPt100 resistance

19 Cu10 GOST: 1/10 the Cu100 GOST resistance

20 Detected current value: approx. 10 μA

Measuring accuracy when scaling:

Measuring accuracy when scaling (digits) = measuring accuracy (digits) × scaling span (digits)/measurement span (digits) + 2 digits

\* Fractions rounded up



## Analog output

- Number of outputs: 2
- Output types: Current, voltage pulse, or DC loop power supply (15 VDC)
  - Current output:
    - Output signal: 4 to 20 mA or 0 to 20 mA (reverse output possible)
    - Load resistance: 600  $\Omega$  or less
    - Output:  $\pm 0.1\%$  of F.S. Except  $\pm 5\%$  of F.S. (F.S.: 20 mA) for 1 mA or less
    - Temperature effect:  $\pm 200$  ppm/ $^{\circ}\text{C}$
    - Humidity effect:  $\pm 0.05\%$  of F.S. @40 $^{\circ}\text{C}$ , 93%RH
    - Long-term drift:  $\pm 0.05\%$  of F.S.
  - Voltage pulse output:
    - ON voltage: 12 VDC or more (load resistance of 600  $\Omega$  or more)
    - OFF voltage: 0.1 VDC or less
    - Cycle time: 0.5 to 1000.0 s
    - Time resolution: 10 ms or 0.1% of output value, whichever is larger
  - DC loop power supply:
    - Supply voltage: 13.0 to 18.3 V
    - Maximum supply current: about 22 mA (with short-circuit current limiting circuit)
- Output calculation: split computation

## Digital Input/Output

### Digital Input

- Number of inputs: 8
- Status detection minimum hold time: control period + 50 ms
- Input type: no-voltage contact or open collector
- Isolation type: photocoupler isolation
- Contact rating: 12 VDC or more, 20 mA or more
  - Using a contact with a minimum ON current of 1 mA or less
- Input resistance: about 2.4 k $\Omega$
- Allowable input voltage: 10 V
- Input detection:
  - For open collector contact input
    - ON voltage: 0.5 VDC or less
    - Leakage current when turned off: 0.5 mA or less
  - For no-voltage contact input
    - Contact resistance when turned on: 200  $\Omega$  or less
    - Contact resistance when turned off: 50 k $\Omega$  or more
- Number of commons: 1
- Application: SP switching, operation mode switching, event input

### Digital Output

- Number of outputs: 8
- Output time resolution: 100 ms min.
- Output type: open collector (sink type)
- Isolation type: photocoupler isolation
- Output contact capacity: 24 V DC max., 50 mA
- Application: alarm output, FAIL output, etc.

## Withstand voltage

- Between analog input terminals and internal circuit: 1500 V AC for 1 minute
- Between analog output terminals and internal circuit: 1500 V AC for 1 minute
- Between digital input terminals and internal circuit: 1500 V AC for 1 minute
- Between digital output terminals and internal circuit: 1500 V AC for 1 minute

- Between input terminals and output terminals: 1000 V AC for 1 minute
- Between analog input channels: 1000 V AC for 1 minute
- Between analog output channels: 20 M $\Omega$  or more at 500 V AC
- Between analog I/O terminals and digital I/O terminals: 1000 V AC for 1 minute

## Insulation resistance

- Between analog input terminals and internal circuit: 20 M $\Omega$  or more at 500 V DC
- Between analog output terminals and internal circuit: 20 M $\Omega$  or more at 500 V DC
- Between digital input terminals and internal circuit: 20 M $\Omega$  or more at 500 V DC
- Between digital output terminals and internal circuit: 20 M $\Omega$  or more at 500 V DC
- Between input terminals and output terminals: 20 M $\Omega$  or more at 500 V DC
- Between analog input channels: 20 M $\Omega$  or more at 500 V DC
- Between analog output channels: 20 M $\Omega$  or more at 500 V DC
- Between analog I/O terminals and digital I/O terminals: 20 M $\Omega$  or more at 500 V DC

## Standards Compliance

- CSA:
  - CAN/CSA-C22.2 No. 61010-1, installation category II,<sup>1</sup> pollution degree 2<sup>2</sup>
  - CAN/CSA-C22.2 No. 61010-2-030
  - CAN/CSA-IEC 61010-2-201<sup>4</sup>
- UL:
  - UL 61010-1, UL 61010-2-030 (CSA NRTL/C)
  - UL 61010-2-201(CSA NRTL/C)<sup>4</sup>
- CE/EMC directives:
  - EN 61326-1 compliance, Class A Table 2
  - EN 61000-3-2 compliance
  - EN 61000-3-3 compliance
  - EN 55011 Class A Group 1
- CE/Low-voltage directives:
  - EN 61010-1, EN 61010-2-030 compliance
  - installation category II,<sup>1</sup> pollution degree 2,<sup>2</sup> measurement category II<sup>3</sup>
  - EN 61010-2-201 compliance<sup>4</sup>
- Australia, New Zealand EMC standard (RCM):
  - EN55011 compliance, Class A Group 1
- KC mark:
  - Electromagnetic wave interference prevention standard, electromagnetic wave protection standard compliance
- \*1 Installation category (overvoltage category) II: Describes a number which defines a transient overvoltage condition. Implies the regulation for impulse withstand voltage. "II" applies to electrical equipment which is supplied from the fixed installation like a distribution board.
- \*2 Pollution degree 2: Describes the degree to which a solid, liquid, or gas which deteriorates dielectric strength or surface resistivity is adhering. "2" applies to normal indoor atmosphere. Normally, only non-conductive pollution occurs.
- \*3 Measurement category II (CAT II): Available in the testing and measuring circuits directly connected to a usage location (receptacle or the like) of a low-voltage main power supply facility. Appliances, portable equipment, etc.

- \*4 This product is designed as open equipment under the relevant standard, install it as follows:
- The GX10/GX20 is designed to be installed in an instrumentation panel. Install it in a location where people cannot touch the terminals carelessly.
  - To make the GP10/GP20 comply with the relevant standard, support the parts of the device other than the front-panel control area with an instrumentation panel or the like, and install it in a location where people cannot touch the terminals carelessly or in a panel.
  - Install the GX60/GM unit in a panel with a door.
  - The instrumentation panel or panel used for support must comply with CSA/UL/EN 61010-2-201 or must be at least IP1X (degrees of protection) and at least IK09.
  - To comply with the relevant standard, make sure that the style numbers of the GX/GP main unit, GM90PS power supply module, and GX60 I/O base unit are at least 2.
- WEEE Directive Compliant

### Construction

- Front panel (terminal) area: Dust-proof and drip-proof, IEC529-IP20
- Material: Polycarbonate
- Color:
  - Front panel: Light charcoal gray (Munsell 10B 3.6/0.3 equivalent)
  - Case: Smoke gray (Munsell 4.1PB 6.0/4.5 equivalent)
- External dimensions: 45.2 (W) x 111 (H) x 133.1 (D) mm (D: depth including the terminal cover)
- Terminal type: M3 screw terminal
- Weight: Approx. 0.3 kg

### Power supply

- Supplied from GX/GP, GX60, GM90PS
- Power consumption: 2.8 W or less

### Isolation

Analog input CH1	Internal circuit
Analog input CH2	
Analog output CH1	
Analog output CH2	
Digital input CH1 to 8	
Digital output CH1 to 8	

— Functional isolation

### Terminal arrangement: M3 screw terminal

No.	Symbol	No.	Symbol	No.	Symbol
301	DI3	201	DI2	101	DI1
302	DI6	202	DI5	102	DI4
303	DI-COM	203	DI8	103	DI7
304	DO3	204	DO2	104	DO1
305	DO6	205	DO5	105	DO4
306	DO-COM	206	DO8	106	DO7
307	AI1(/A)	207	AI1(-/b)	107	AI1(+/B)
308	AI2(/A)	208	AI2(-/b)	108	AI2(+/B)
309	N.C.	209	AO1(-)	109	AO1(+)
310	N.C.	210	AO2(-)	110	AO2(+)

### A/D Calibration Value

You can save two types of AD calibration values: factory default values and user-defined values. If there is a problem with user-defined values, they can be reset to factory default calibration values.

### External Dimensions

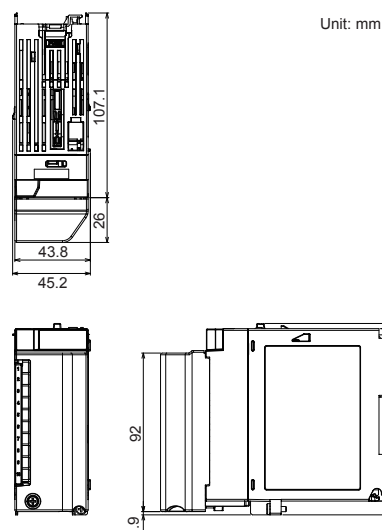

### Normal Operating Conditions

- Ambient temperature:  $-20$  to  $50^{\circ}\text{C}$   
However, use it within the ambient temperature range defined for the GX/GP/GM main unit.  
For the normal operating conditions of this module, see the specifications of the instrument (GX/GP, expandable I/O, GM) that this module is installed in.  
GX specifications: GS 04L51B01-01EN  
GP specifications: GS 04L52B01-01EN  
Expandable I/O specifications: GS 04L53B00-01EN  
GM specifications: GS 04L55B01-01EN

### Transport and Storage Conditions

- Ambient temperature:  $-25$  to  $70^{\circ}\text{C}$
- Ambient humidity: 5 to 95% RH (no condensation)
- Vibration: 10 to 60 Hz,  $4.9\text{ m/s}^2$  or less
- Shock:  $392\text{ m/s}^2$  maximum (in packaged condition)

### Effects of Operating Conditions

- Effects of ambient temperature:
  - Fluctuation per  $10^{\circ}\text{C}$  change  $\pm(0.05\%$  of rdg +  $0.05\%$  of range) or less  
However, for KpvsAu7Fe, PR20-40:  $\pm(0.05\%$  of rdg +  $0.1\%$  of range) or less
  - Cu10 $\Omega$  or less:  $\pm(0.2\%$  of range +  $0.1^{\circ}\text{C}$ ) or less
- Effects of power fluctuation:
  - Meets the accuracy specifications in the rated power supply range
- Effects of magnetic field:
  - Fluctuation in response to a magnetic field of AC (50/60 Hz) 400 A/m is  $\pm(0.1\%$  of rdg +  $0.1\%$  of range) or less.

Block Diagram

Single Loop Control Block Diagram

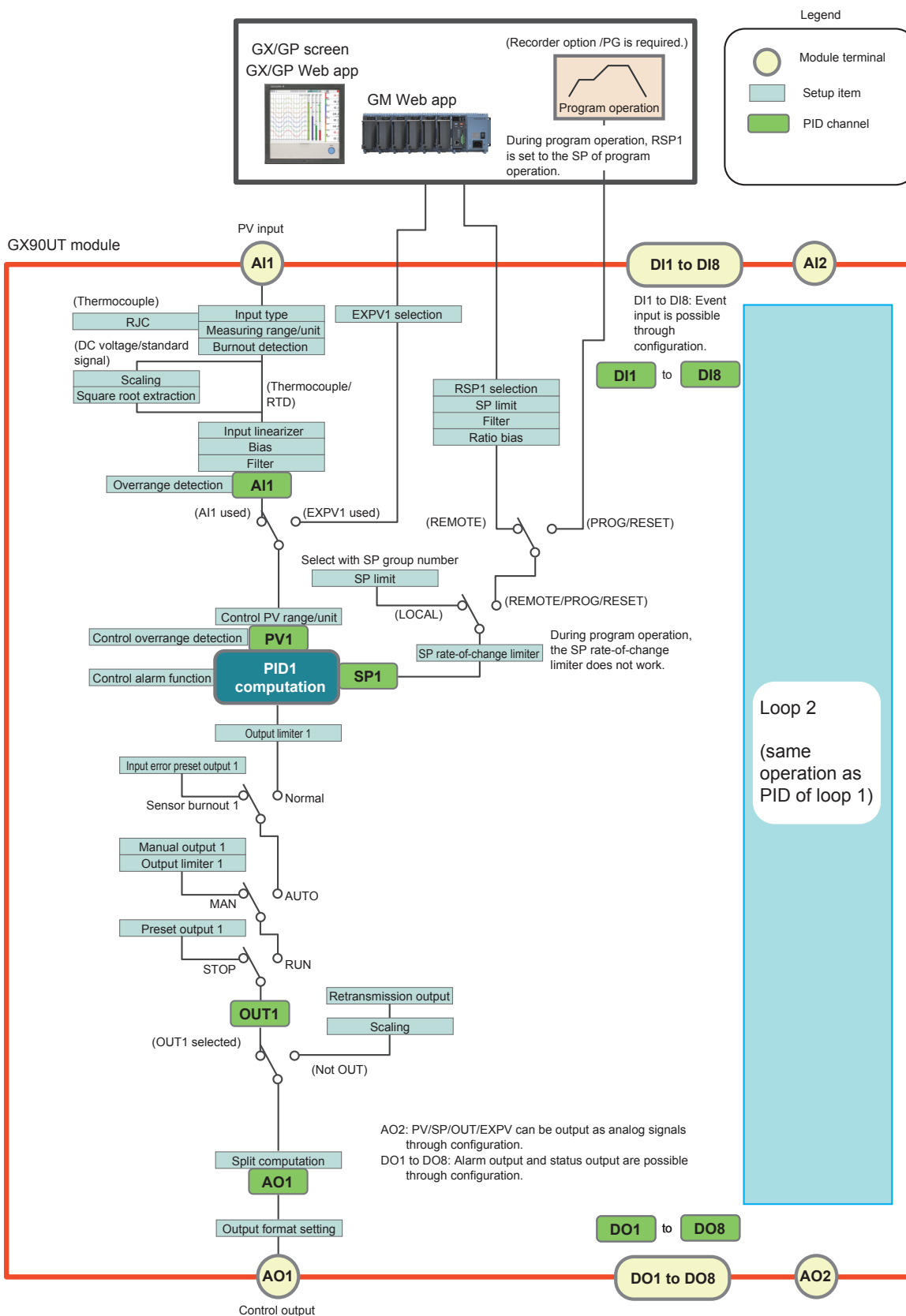

### Cascade Control Block Diagram

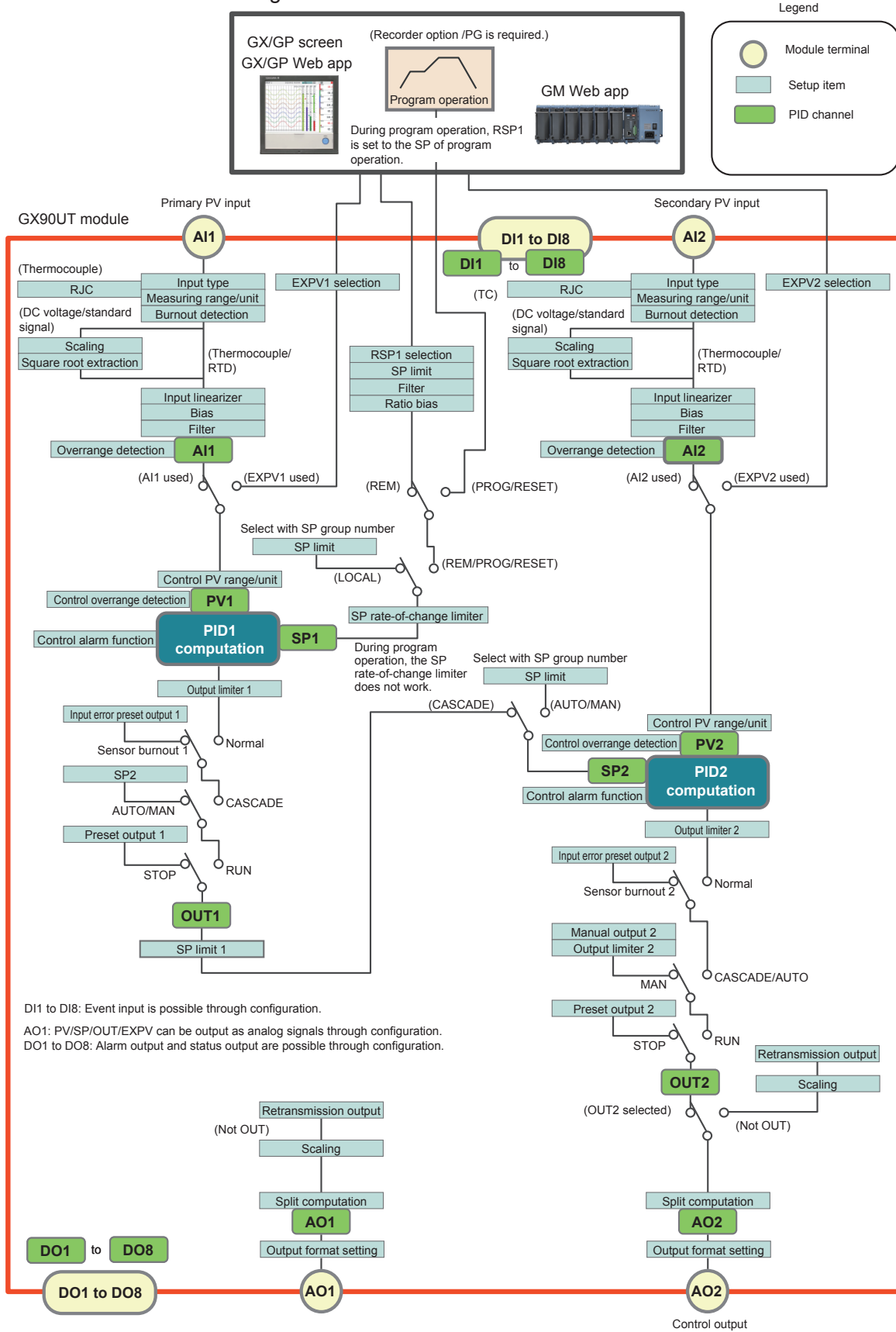

# Loop Control with PV Switching Block Diagram

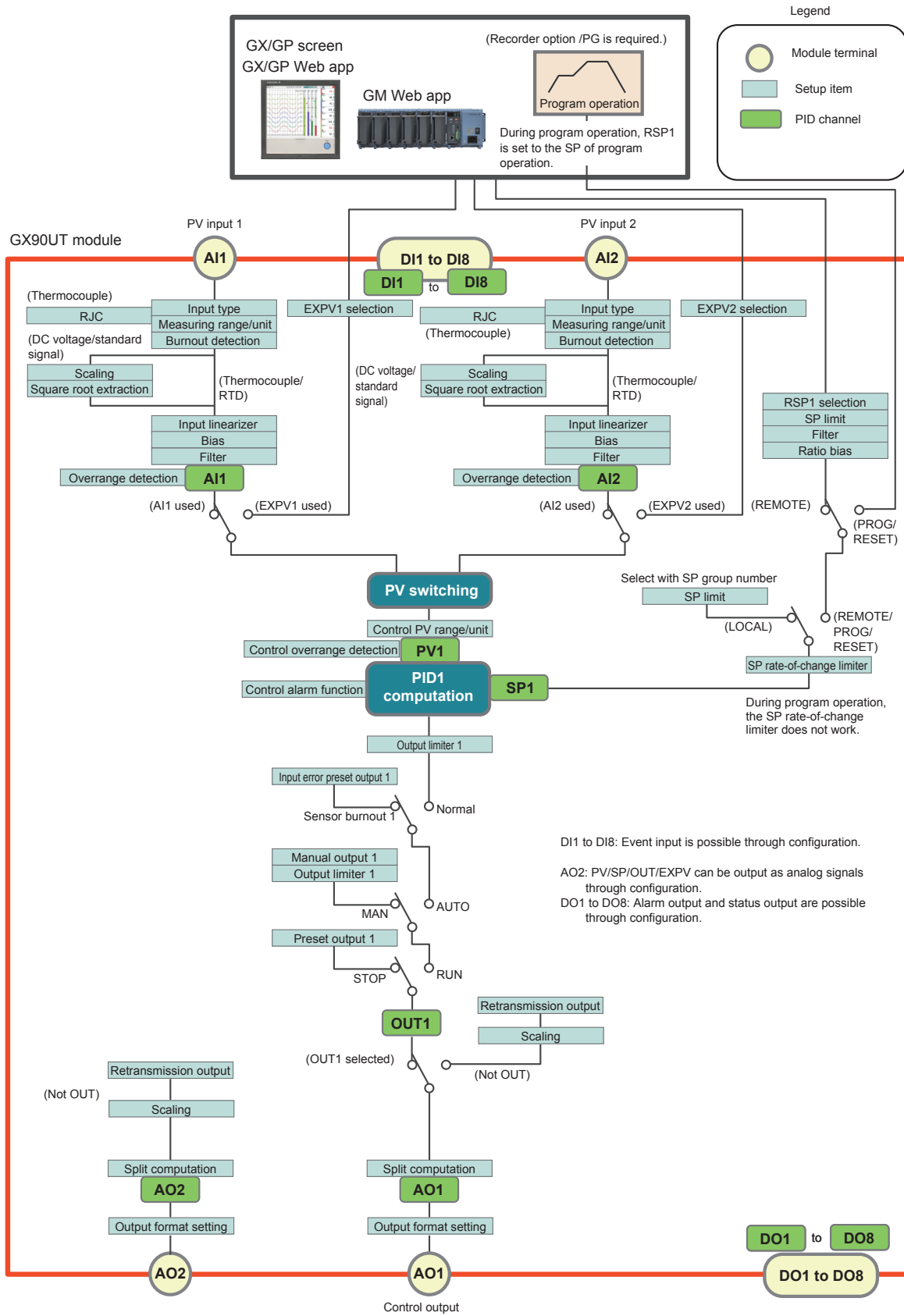

## Loop Control Function (Function of the GX/GP/GM Main Unit)

This function can be used when a PID Control Module is installed in GX/GP main unit, expandable I/O, GM main unit, or sub unit.

### Control Screen

Display update interval (GX/GP): 500 ms (fixed)

On the GM, a Web application is used to perform operations similar to those performed on the GX/GP main unit's screen.

### Control Group Screen

Multiple loops can be shown as a group (control group) on a single screen.

Controller style: A screen that emphasizes PV values as on a digital indicating controller

Display items: Tag No., tag string, operation mode, operating status, control alarm status, PV value, PV unit string, deviation status, SP value, OUT value, OUT unit string, error display

Faceplate style: A screen that shows control values graphically.

Display items: Same items shown on the controller style display as well as PV scale high and low limits, bar graph of PV value, PV alarm high and low limit marks, bar graph of OUT value, SP pointer



### Control Group Screen

#### Number of Control Groups and Number of Loops That Can Be Registered

Model	Number of Groups (max.)	Number of Loops (max.)/Group
GX10/GP10	5	6
GX20-1/GP20-1 (standard type)	5	8
GM10-1 (standard type)	5	8
GX20-2/GP20-2 (large memory type)	10	8
GM10-2 (large memory type)	10	8

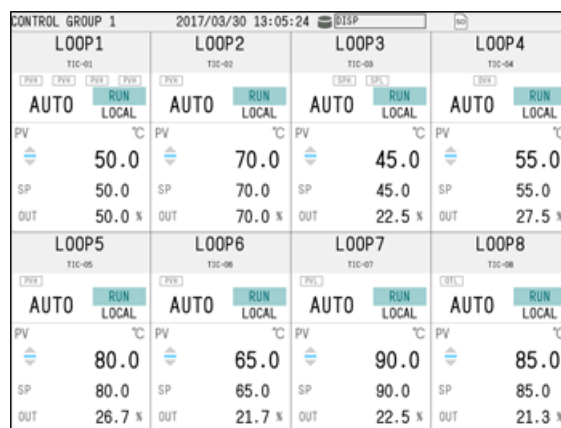

Controller style display example

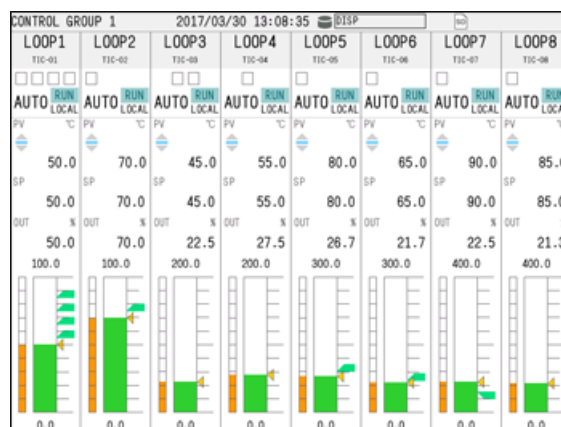

Faceplate style display example

### Control Overview Screen

The control overview screen shows on a single screen the alarm status of all loops.

When an alarm occurs, the background color turns red and the text color white.

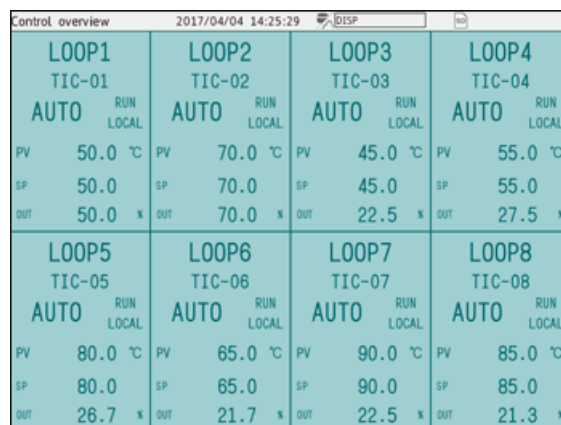



### Tuning Screen

The tuning screen can be used to set or adjust PID constants and the like while viewing process data during operation.



### Control Summary Screen

The control summary screen shows a history of control operations (run/stop, auto/manual, etc.). You can select a historical entry and jump to the historical trend of that section.

- Displayed contents: name, status, time
- Maximum number of summaries: 1000 (if the maximum number is exceeded, the oldest event is deleted)

UP	DOWN	Name	Status	Time
		LOOP7	RUN	2017/03/30 12:36:03
		LOOP3	AUTO	2017/03/30 12:36:00
		LOOP7	STOP	2017/03/30 12:35:37
		LOOP3	MANUAL	2017/03/30 12:35:24
		LOOP8	RUN	2017/03/30 11:08:19
		LOOP8	AUTO	2017/03/30 11:08:18
		LOOP7	RUN	2017/03/30 11:08:15
		LOOP7	AUTO	2017/03/30 11:08:14
		LOOP6	RUN	2017/03/30 11:08:11
		LOOP6	AUTO	2017/03/30 11:08:10
		LOOP5	RUN	2017/03/30 11:08:08

### Control Alarm Summary Screen

The control alarm summary screen shows a history of control alarms. You can select a historical entry and jump to the historical trend of that section.

- Displayed contents: loop, level, type, time
- Maximum number of summaries: 500 (if the maximum number is exceeded, the oldest event is deleted)

UP	DOWN	Loop	Level	Type	Alarm time
		LOOP4	2	DVH	2017/03/30 12:18:33.730
		LOOP4	2	DVH	2017/03/30 11:56:10.730
		LOOP4	2	DVO	2017/03/30 11:45:37.130
		LOOP4	2	DVO	2017/03/30 11:45:13.430
		LOOP7	1	PVL	2017/03/30 11:40:55.130
		LOOP8	1	OTL	2017/03/30 11:40:09.230
		LOOP8	1	OTL	2017/03/30 11:39:55.830
		LOOP4	2	DVL	2017/03/30 11:39:30.330
		LOOP7	1	PVL	2017/03/30 11:39:30.230
		LOOP7	1	PVL	2017/03/30 11:39:30.110
		LOOP4	2	DVL	2017/03/30 11:36:09.330

### Multi Panel Screen

You can assign a control group screen, control overview screen, control alarm summary screen, and control summary screen to the multi panel screen.

The control group screen and control overview screen may not be displayed depending on the size of the multi panel area that they are assigned to.

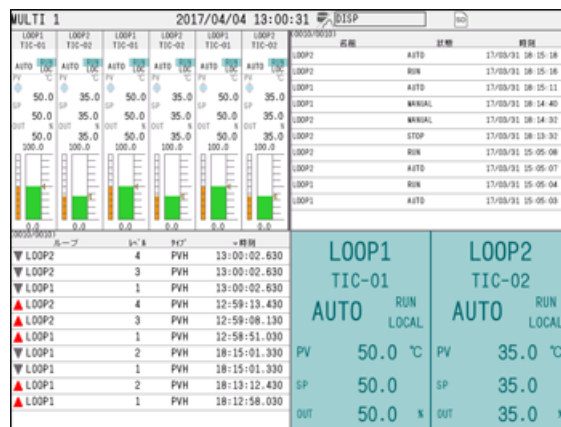

### Favorite and Standard Screens

Control screens can be registered to favorite and standard screens.

### Background Color

The background color of control screens can be set to white or black.

(Controller style display example)

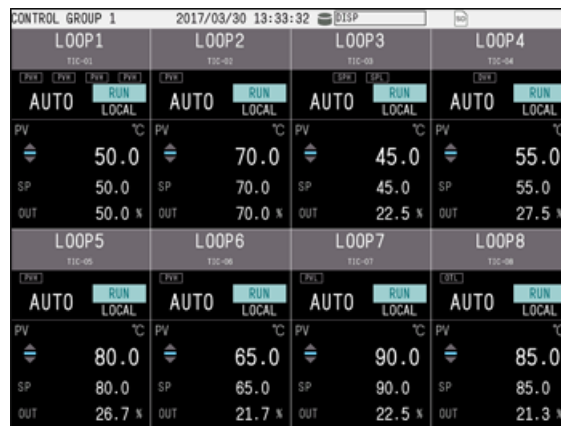

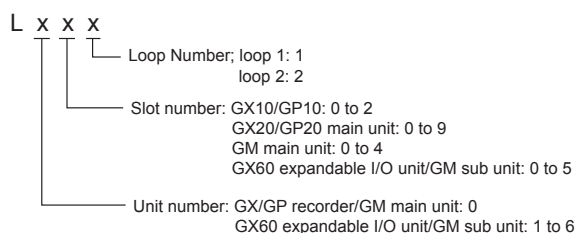
**Loop Number:****Tag:**

Tag strings and tag numbers can be assigned to loop numbers.

- Tag string: up to 32 characters  
Displayable characters: English, Japanese, and Chinese characters
- Tag No.: up to 16 characters  
Displayable characters: Alphanumeric and symbols

**PID Channel:**

PID channels are used to display control data and I/O data of PID control modules on trend or digital displays and save the data as recorded data.

- PID channel:  
analog input (AI1/AI2), digital input (DI1 to DI8), analog output (AO1/AO2), digital output (DO1 to DO8), control data (PV1/PV2, SP1/SP2, OUT1/OUT2)
- PID channel recording interval: depends on the recorder's recording interval

**PID Channel Display Settings:**

tag, color, zone, scale, bar graph

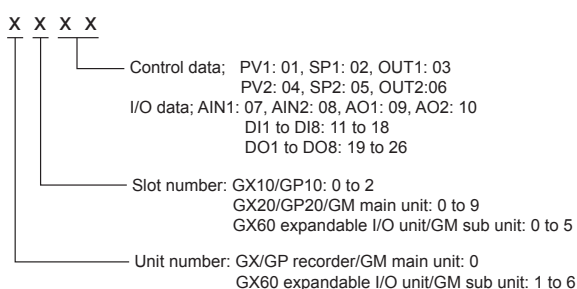
**Number of PID Channels:**

The number of channels of the GX90UT module is 26 (fixed).

When choosing the type of GX / GP / GM main unit (Standard / Large memory), please calculate it as 26 channels per one unit.

**Control Functions****Control Mode**

Select from single loop control, cascade control, and loop control with PV switching

- \* Two single loops can run on a single unit. (Dual-loop control is possible.)

**Number of Control Loops**

2 loops/ module (single loop control×2, cascade control)

1 loop/module (loop control with PV switching)

- GX/GP/GM system (standard type): 6 loops max.
- GX/GP/GM system (large memory type): 20 loops max.

**Control Period (Input Sampling Period)**

100 ms or 200 ms (system global setting)

**Control Computation Function**

- Control type: PID control, on/off control
- Target setpoint (SP): up to 8 per loop
- PID parameter: 8 groups/loop
- PID parameter group selection:  
Using target setpoint numbers (SPNO) (PID numbers can be assigned as you like) or segment PIDs (during program control)  
Using PV input zones (zone PIDs)\*  
Using target setpoint zones (zone PIDs)\*  
Using final target setpoint zones (zone PIDs)\*  
Externally (using the contact input)  
\* If the deviation exceeds the reference deviation setpoint during constant preset control, the PID constant switches automatically to the preset PID parameter group.

- Zone PID switches: 7 max.
- PID default setting function: The controlled target can be set to a PID constant suitable for the temperature or that suitable for the pressure or flow rate.
- PID control mode:  
fixed-point control mode or constant preset control
- SP limiter function: A high limit or low limit can be set.
- SP ramp rate setting function: A rising ramp rate or falling ramp rate can be set.
- Tracking function:  
SP tracking, PV tracking
- Auto-tuning function
- "Super" function (overshoot-suppressing function)
- Anti-reset windup (over-integration prevention function)
- Preset function (when operation is stopped)
- Input error preset function

**Operation Mode Switching**

Remote/local (R/L), auto/manual (A/M), run/stop (R/S), cascade/auto/manual (CAS/AUTO/MAN), auto tuning (AT) run/stop



**Control Parameter Setting Range**

- Proportional band (P): 0.0 to 999.9%
- Integral time (I): 0 to 6,000 s
- Derivative time (D): 0 to 6,000 s
- ON/OFF control hysteresis: 0.0 to 100.0% of measuring range (high and low can be set separately)
- Preset output value: -5.0 to 105.0%
- Output limiter setting range: -5.0 to 105.0% (limiter low limit < limiter high limit)
- Normal/reverse operation switching: normal or reverse
- Tight shut function: When manual control is carried out with 4 to 20 mA output, control output can be reduced to about 0 mA.
- Rate-of-change limiter of output: Off or 0.1 to 100.0%/s

**External PV (EXPV)**

External PV can be turned on and off. An I/O, math, or communication channel can be assigned to PV. EXPV send period: 100ms to 500ms (depends on the system configuration.)

**Remote SP (RSP)**

Remote SP can be turned on and off. An I/O, math, or communication channel or the analog input of a PID control module can be assigned to SP. A filter and ratio bias can be set on the remote SP. Remote SP send period: 100ms to 500ms (depends on the system configuration.)

**Retransmission Output (Analog Retransmission) Function**

Output function: current output (reverse output possible)  
PV, SP, or OUT can be retransmitted from analog output.

**Math Function**

CP computation (zirconia O<sub>2</sub> sensor electromotive force, CO<sub>2</sub> partial pressure), special CLOG.AVE computation, magic number

- \* The math function is a recorder option (/MT). For details, see the general specifications of the GX/GP/GM recorder.

**Alarm Function**

- Control alarm types  
PV high limit, PV low limit, SP high limit, SP low limit, deviation high limit, deviation low limit, deviation high and low limits, deviation within high and low limits, control output high limit, control output low limit, PV rate-of-change
- Alarm action  
Standby action, relay action (hold/nonhold, reset on ACK, normal action on ACK), hysteresis, ON-delay timer, Off-delay timer
- Number of alarm setpoints: 4 per loop
- Standby action  
Turns off alarms from the start of control (power-on) until a stable condition is reached.
- Hysteresis: Hysteresis can be set for each alarm setting.
- Display: status display in the digital display area when an alarm occurs. Common alarm display can be switched between hold and nonhold.

**Other Functions**

- Recorder operation  
Operation  
Operation security settings

**Control Event Action**

Control action or status output can be performed using DI, DO, and internal switch.

- Action

All loop control operation start
All loop control operation stop
Control operation start/stop (specified loop)
Auto/manual switch (specified loop)
Remote/local switch (specified loop)
Auto switch (specified loop)
Manual switch (specified loop)
Cascade switch (specified loop)
Remote switch (specified loop)
Local switch (specified loop)
Hold operation
Advance operation
Program operation start
Program operation stop
Program operation mode change
Hold operation (specified loop, specified program pattern)
Advance operation (specified loop, specified program pattern)
Program operation start (specified loop, specified program pattern)
Program operation stop (specified loop, specified program pattern)
Pattern number switch (BIN, BCD)

- Status output
  - Notification during control operation
  - Segment number (BIN, BCD)
  - Pattern number (BIN, BCD)
  - PROG/RESET monitoring
  - Wait end signal (1s, 3s, 5s)
  - Pattern end signal (1s, 3s, 5s)
  - PV event status
  - Time event status
  - Wait flag
  - Hold-on flag

## ■ Program Control Function (/PG GX/GP/GM recorder option)

With the program control function, a PID control module installed in the GX/GP main unit, expandable I/O, GM main unit or sub unit can control a system according to time varying setpoints sent from the GX/GP/GM main unit.

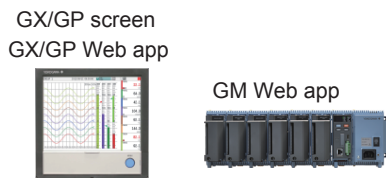

(Recorder option /PG is required.)

Program patterns are executed by operating the GX/GP or GM recorder or Web app.

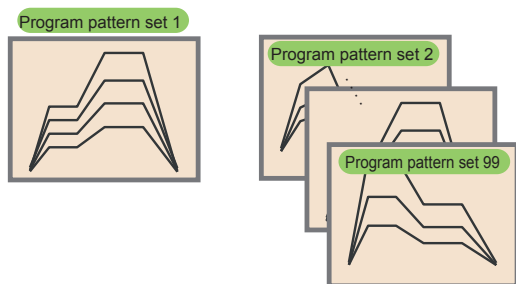

99 program pattern sets

- Number of program pattern sets: 99
- Program pattern name: up to 20 characters
- Number of segments: 99 segments/pattern
- Number of simultaneous execution: 1 pattern only
- SP update period: 100 to 500 ms (depends on the system configuration)
- PV events:
  - PV alarms, deviation alarms, and the like in program patterns
  - Maximum number of events: 32 per segment
  - Type: PV high limit, PV low limit, SP high limit, SP low limit, deviation high limit, deviation low limit, deviation high and low limits, deviation within high and low limits, control output high limit, control output low limit
- Time event:
  - Status output is possible according to the progress of program patterns.
  - Maximum number of events: 32 per segment
  - Time setting: 0 to (segment time - 1 s)
- Operation mode switching:
  - Program run/reset, hold/release hold, advance execute, local operation
- Number of pattern repetitions:
  - 999 max. or infinite
- Segment time:
  - 0 hours 0 minutes 1 second to 99 hours 59 minutes 59 seconds

- Program pattern start/stop:
  - Program pattern start, stop, hold, and advance can be controlled from digital input, communication, or recorder's screen.
- Program pattern selection:
  - can be controlled from digital input, communication, or recorder's screen.
- Advance function: forcibly moves to the next segment
- Wait function:
  - Wait time:
    - off, 0 hours 0 minutes 1 second to 99 hours 59 minutes 59 seconds
  - Wait zone: 0.0 to 10.0% of PV range span
- Hold function: available
- PID parameter switching:
  - Segment PID switching:
    - PID parameter number can be switched for each segment.
  - Zone PID switching:
    - PID parameters can be switched using PV values and the like.
- Status output through digital output (control event action)
  - Status monitoring is possible using digital output.
    - Program pattern number monitoring,
    - program end (pattern end) notification,
    - segment number monitoring, operation mode monitoring (PROG/REST), wait end notification, PV/time event notification, waiting notification, holding notification, local operation

### Program Selection Screen

The program selection screen is for selecting the program pattern to start operations and viewing pattern settings.

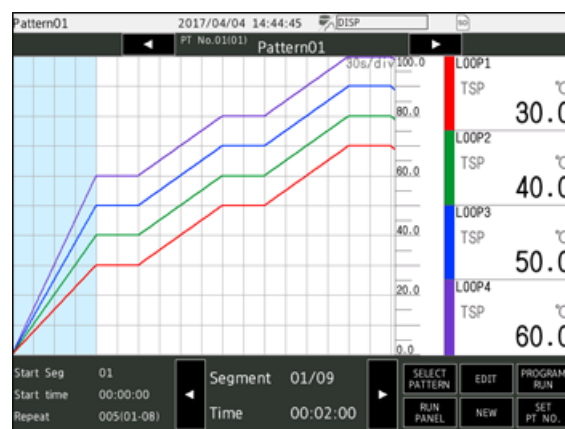

- Program screen display:  
Program operation status display screen:  
displays the program operating status and the current PV simultaneously (GX/GP only)  
Number of display loops: 20 max.  
Number of screens: 1  
Display update interval:  
Digital display area: 500 ms fixed  
Trend display area: according to the trend interval  
Program event display: possible

### Program Operation Screen

The program operation screen is for displaying the program pattern that is currently running.

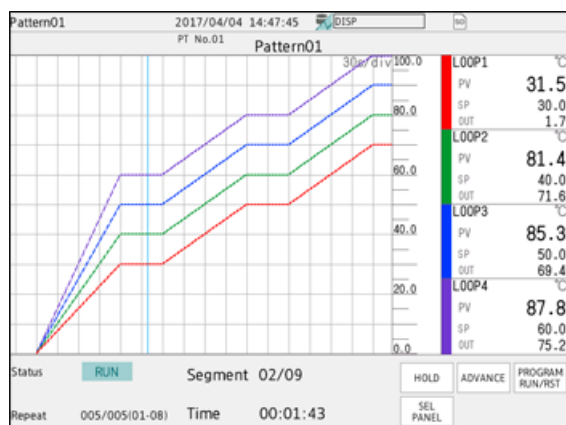

- Other recorder operations:  
Save each program pattern to file  
Load program patterns  
Delete program patterns

## Control Data Acquisition/Recording Function (GX/GP/GM recorder function)

- Acquires/records control data (PV, SP, OUT, etc.)  
Acquisition/recording is possible by installing a PID Control Module and reconfiguring the system.  
PID channel data can be used as an I/O channel to be saved in data files or used in computation and reports.
- Control operation summary (number of saved files: up to 3000 data values, number of display data values: up to 1000 data values)
- Control alarm summary (number of saved files: up to 1000, number of display data entries: up to 500)

## Installation Conditions

### Systematic PID Control Module Limitations

<b>GX/GP/GM system (Standard type)</b>	Max. 3 devices
<b>GX/GP/GM system (Large memory type)</b>	Max. 10 devices

However, if the system includes PID control modules (GX90UT), digital output modules (GX90YD), and digital input/output modules (GX90WD), the maximum total number of these modules is 10.

If the recorder's measurement operation mode is high speed or dual interval, PID control modules will not work. (For details, see the general specifications of the GX/GP/GM recorder.)

### Input/Output Module Limitations on Recorders and Units When Using the PID Control Module

<b>GX10/GP10 recorder (Standard type)</b>	Max. 3 devices* Note:
<b>GX20/GP20 recorder (Standard type)</b>	Max. 8 devices*
<b>GX20/GP20 recorder (Large memory type)</b>	Max. 8 devices*
<b>GM single unit configuration, main (standard type)</b>	Max. 5 devices*
<b>GM single unit configuration, main (large memory type)</b>	Max. 5 devices*
<b>GM multi unit configuration, main (standard type)</b>	Max. 5 devices*
<b>GM multi unit configuration, main (large memory type)</b>	Max. 5 devices*
<b>GX60 expandable I/O</b>	Installable within the system limitations
<b>GM multi unit configuration, sub unit</b>	Installable within the system limitations

\* This is the number of devices including the expansion modules (GX90EX) installed in the GX/GP/GM recorder when an expandable I/O unit (GX60) or GM sub unit is used.

Note: The maximum number is 2 when the GP10 supply voltage is 12 VDC.

## ■ Model and Suffix Codes

### Model and Suffix Codes (GX90UT)

Model	Suffix code			Description
GX90UT				PID Control Module
Number of loops	-02			2 loops
Function		-11		DI 8 points, DO 8 points
-		N		Always N
Terminal type			-3	Screw terminal (M3)
Region			N	General

## ■ Optional Accessories (Sold separately)

Name	Type
Shunt resistor for current input (for M3 screw terminal) ( $250 \Omega \pm 0.1\%$ )	415940
Shunt resistor for current input (for M3 screw terminal) ( $100 \Omega \pm 0.1\%$ )	415941
Shunt resistor for current input (for M3 screw terminal) ( $10 \Omega \pm 0.1\%$ )	415942

### Calibration Certificate (Sold separately)

When you order PID control modules, each module gets its own calibration certificate.

### Test Certificate (QIC, sold separately)

When you order PID control modules, each module gets its own QIC.

### User's Manual

You can download the product user's manuals from the following URL. You will need Adobe Reader 7 or later (latest version recommended) by Adobe Systems.

**URL:** [www.smartdacplus.com/manual/ja/](http://www.smartdacplus.com/manual/ja/)

### Trademarks

The TCP/IP software used in this product and the document for that TCP/IP software are based in part on BSD networking software, Release 1 licensed from The Regents of the University of California. SMARTDAC+ and SMARTDACPLUS are trademarks of Yokogawa Electric Corporation.

Microsoft, MS, and Windows are trademarks or registered trademarks of Microsoft Corporation in the United States and other countries.

Pentium is a registered trademark of Intel Corporation.

Modbus is a registered trademark of AEG Schneider. Other company names and product names appearing in this document are registered trademarks or trademarks of their respective holders.

The company and product names used in this manual are not accompanied by the registered trademark or trademark symbols (® and ™).