

Model 515 Flow Computer

Operation Manual

Application HC01

Heat Calculator - Flow Computer
for
Frequency Flowmeters



18 June 2017

Model 515 Flow Computer - Operation Manual

© Contrec Limited 2017

The instructions given herein cover the general description, installation, operation and maintenance of the subject equipment. Contrec Limited. reserves the right, without prior notice, to make engineering refinements that may not be reflected in this manual.

Should any questions arise which cannot be answered specifically by this manual, they should be directed to Contrec Limited for further detailed information and technical assistance.

Contrec Limited will not accept any liability for either direct or consequential damages resulting from the use or misapplication of the contents of this manual.

Part of the software embedded in this product is eCos - Embedded Configurable Operating System, a trademark of Red Hat. Portions created by Red Hat are Copyright © 1998, 1999, 2000 Red Hat, Inc. (<http://www.redhat.com>). All rights reserved

The software in this product was in part provided by Red Hat and any express or implied warranties, including, but not limited to, the implied warranties of merchantability and fitness for a particular purpose are disclaimed. In no event shall the author be liable for any direct, indirect, incidental, special, exemplary, or consequential damages (including, but not limited to, procurement of substitute goods or services; loss of use, data, or profits; or business interruption) however caused and on any theory of liability, whether in contract, strict liability, or tort (including negligence or otherwise) arising in any way out of the use of this software, even if advised of the possibility of such damage.

Contrec Limited

Riverside, Canal Road, Sowerby Bridge,
West Yorkshire HX6 2AY UNITED KINGDOM
Tel: +44 1422 829944 Fax: +44 1422 829945
Email: sales@contrec.co.uk

Website: www.contrec.co.uk

Contrec Systems Pty Ltd

5 Norfolk Avenue Ringwood, Melbourne 3134 AUSTRALIA
Tel: +61 4 413 505 114
Email: info@contrec.com.au

Contrec - USA, LLC

916 Belcher Drive Pelham AL 35124 USA
Tel: +1 (205) 685 3000 Fax: +1 (205) 685 3001
Email: contrec@contrec-usa.com



Publication No: 515-HC01-OM - 18 June 2017



Safety Notice

The information in this safety notice is for the prevention of injury to personnel and damage to the instrument.

The manufacturer assumes no liability for injury or damage caused by misuse of the instrument or for modifications made to the instrument.

Qualified Personnel

The instrument must be installed, operated and serviced by persons who have been properly trained and authorised. Personnel must read and understand this manual prior to installation and operation of the instrument.

Static Hazard

The 500 series flow computer uses high speed CMOS circuitry which is sensitive to static damage. The user should observe accepted safety practices for handling electronic devices, especially during servicing. Once the unit is installed, grounded and interconnected, the chances of static damage are greatly reduced.

Voltage Hazard

Before connecting power to the instrument, ensure that the supply voltage for the AC or DC input is suitable. The AC voltage rating is as stated on the instrument rating plate. Personnel should take all due care to avoid electric shock. For safe operation it is essential to connect a mains safety earth to the A.C. power inlet. Do not operate at altitudes above 2000m.

Welding Hazard

Do not perform electric welding in close proximity to the instrument or its interconnecting cables. If welding in these areas must be performed, disconnect all cables from the instrument. Failure to do so may result in damage to the unit.

Moisture Hazard

To avoid electrical faults and corrosion of the instrument, do not allow moisture to remain in contact with the instrument.

Disconnection Device

When powered from a mains supply this unit requires the provision of a suitable mains isolation device to be accessible near to the installed instrument.

Contents

1 Introduction

Features	1
Overview	1
Operation Modes	2
Calculations	2
Analog Input Scaling	3
Displayed Information	3
Main Menu Variables	4
Communications	4
Isolated Outputs	4
Relay Outputs	4
Software Configuration	5
Temperature Input Types	5
Limitations of Use	5
Approvals	6

2 Specifications

Specification Table	9
---------------------	---

3 Installation

Panel Mounting	11
Electrical Connection	12
Rear Panel Connections	12
Terminal Designations	12
Inputs	13
Frequency Input Connection	13
Analog Input Connections	14
Logic Input Connection	16
Outputs	17
4-20mA Output Connection	17
Pulse Output Connection	18
Control Relays (Alarms)	18
RC Network for Interference Suppression	19
Communications	20
RS-232 Port	20
RS-485 Port (Optional)	20
Earthing and Shielding	21

4 Operation

Normal Operation	23
Default Total	23
Status LEDs	23
Front Panel Keys	24
Main Menu Items	24
Peak Flowrates	25
Data Logs	25
Model Information	28

5 Instrument Calibration

Introduction	29
Calibration View Mode	29

Calibration Set Mode	30
Changing the Instrument Settings	31
Calibration Menu Tree	32
Instrument Settings	34
Units of Measurement	34
Parameters	35
Inputs	36
Outputs	40
Alarms	42
Communications	44
Time Settings and Data Logging	45
General Setup Parameters	48
Test Menu	49
System Messages	50
Error Messages	51
Warning Messages	52
6 Communications	
Overview	53
Hardware Interconnection	53
Protocols	55
Simple ASCII Protocol	55
Requests Format	55
Instrument Responses	57
Corrupted or Invalid Requests	60
Modbus RTU Protocol	61
List of Data Registers	62
Printer Protocol	66
Types of Printouts	67
Printer Data Control	70
Appendix A Glossary	
Glossary	71
Appendix B Model Numbers	
Product Codes	73
Custom Version Codes	74
Application Information Code	74
Appendix C Units of Measurement	
Available Units of Measurement	76
Index	77

List of Figures

1	Typical Application Diagram	5
2	Rear Panel Connections	12
3	Externally Powered Voltage Transmitter	14
4	Internally Powered Voltage Transmitter	14
5	Externally Powered Current Loop	15
6	Internally Powered Current Loops	15
7	RTD Connection	16
8	Logic Inputs Connection Diagram	17
9	Output 4-20mA Connection Diagram	17
10	Output Pulse Connection Diagram	18
11	Relay Connection Diagram	19
12	RS-485 Interface Connections	21
13	Logged Data Display Methods	27
14	Calibration Menu Tree Sheet 1	32
15	Calibration Menu Tree Sheet 2	33
16	RS-232 Cable Connections to a Computer	54
17	RS-485 Connections	54

Chapter 1

Introduction

Features

- Suited for heating and/or cooling operation
- Uses IAPWS-IF97 to determine water properties
- Selection of common industry fluids using internal tables
- Facility for user defined Enthalpy and Density table
- Flow meter can be located in feed or return line
- Selection of second language and user tags
- RTC logging with over 1000 entries
- Programmable pulse width and scaling of pulse output
- 4-20mA retransmission
- RS-232 and RS-485 (optional) serial ports
- Modbus RTU, Printer and other serial port protocols
- Front panel adjustment of 8-24V DC output voltage
- Backlit display

Overview

The 515 HC01 application measures the volume, mass and energy content of fluid in a heating or cooling system by using frequency volume flow input in conjunction with analog feed and return temperature inputs.

A selection of fluids types and modes makes it suitable for many heating/cooling applications. The instrument is compatible with a wide range of flowmeter frequency outputs. Millivolt signals, reed switches, Namur proximity switches or pulse trains can be selected via its smart front-panel programming.

The instrument calculates the mass flow and energy according to the IAPWS Industrial Formulation (1997) when the fluid type is water, while internal enthalpy and density tables are used for the selection of other industry fluids.

Operation Modes

This instrument can be used for various heating and cooling energy delivery systems by selection one of the following operation modes in calibration:

- **HEAT** - Heating mode is used when the application is for heating only and assumes that the Feed Temperature will always be higher than the Return Temperature (positive Δt). If the Feed Temperature is lower than the Return Temperature (negative Δt), then no Energy is totalised however Volumetric Flow is still calculated.
- **COOL** - Cooling mode is used when the application is for cooling only and assumes that the Feed Temperature will always be lower than the Return Temperature (negative Δt). If the Feed Temperature is higher than the Return Temperature (positive Δt), then no Energy is totalised however Volumetric Flow is still calculated.
- **BOTH** - This mode caters for applications where the flow of Energy may be for Heating or Cooling. In this mode Energy is increased regardless of whether the Δt is positive or negative.

Calculations

The following equations identify the derivation of some of the displayed variables. If your interest is more in the operation of the instrument, you can skip this section and allow the instrument to take care of the calculations.

This instrument can calculate the mass and energy for the following common industry fluids:

- Water
- Glycol (35% Solution)
- Brine (27% CaCl_2)
- TYFOXIT F20
- TYFOXIT F40
- Essotherm 500 / Thermaloil
- THERMINOL 55
- User Custom Fluid

Formulas

$$\text{Mass flow} = \text{Volume flow} \times \rho_{\text{flow}}$$

$$\text{Power} = \text{Mass flow} \times (h_{TF} - h_{TR})$$

where:

ρ_{flow} = density at flow conditions

h_{TF} = Specific enthalpy at feed temperature

h_{TR} = Specific enthalpy at return temperature

For further details of these equations or restrictions of use please refer to the appropriate standard or relevant documents.

Analog Input Scaling

The analog inputs in this instrument are scaled by the following general formula:

$$f(A) = P_{min} + (P_{max} - P_{min}) \cdot A^*$$

where:

P_{min} = minimum point (equivalent to offset)

P_{max} = maximum point ($P_{max} - P_{min}$ is equivalent to span)

A^* = normalised signal (0 to 1) with correction applied for a flow input

Displayed Information

The front panel display shows the current values of the input variables and the results of the calculations.

The instrument can be supplied with a real-time clock for data logging of over 1000 entries of the variables as displayed on the main menu.

Main Menu Variables

Main Menu Variables	Default Units	Variable Type
Energy	MWh	Total
Power	MW	Rate
Volume	m ³	Total
Volume Flowrate	m ³ /min	Rate
Mass	kg	Total
Mass Flowrate	kg/min	Rate
Feed Temperature	Deg C	Rate
Return Temperature	Deg C	Rate
Differential Temperature	Deg C	Rate

Refer to [Available Units of Measurement](#) on page 76 for the list of available units.

Communications

There are two communication ports available as follows:

- RS-232 port
- RS-485 port (optional)

The ports can be used for remote data reading, printouts and for initial application loading of the instrument.

Isolated Outputs

The opto-isolated outputs can re-transmit any main menu variable. The type of output is determined by the nature of the assigned variable. Totals are output as pulses and rates are output as 4-20mA signals. One output is standard, a second output is available as an option.

Relay Outputs

The relay alarms can be assigned to any of the main menu variables of a rate type. The alarms can be fully configured including hysteresis. Two relays are standard with additional two relays available as an option.

Software Configuration

The instrument can be further tailored to suit specific application needs including units of measurement, custom tags, second language or access levels. A distributor can configure these requirements before delivery.

Instrument parameters including units of measurement can be programmed in the field, according to the user access levels assigned to parameters by the distributor.

All set-up parameters, totals and logged data are stored in non-volatile memory with at least 30 years retention.

Temperature Input Types

Temperature sensor input(s) can be either PT100, PT500, 4-20mA, 0-5 V or 1-5V signals.

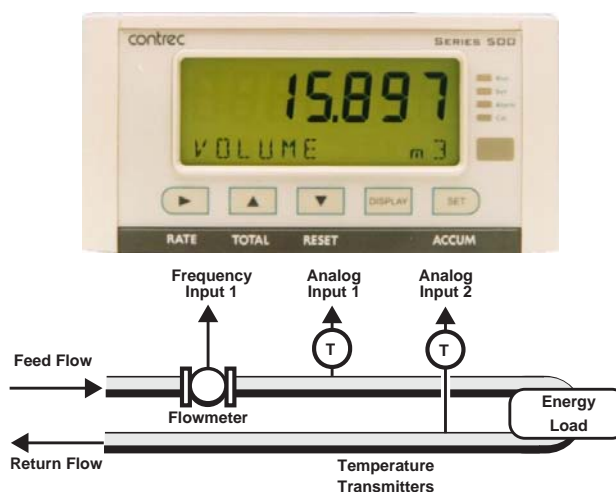

Figure 1 Typical Application Diagram

Limitations of Use

Fluid Types

The instrument can calculate the energy and mass in a heating and/or cooling system for a selection of common industry fluid types.

When used on a water based system, the energy calculations are based on the IAPWS Industrial Formulation (1997). The temperature limits are dependent on the system pressure:

- WATER $0^{\circ}\text{C} < t < t_{\text{saturation}}$ at system pressure
 $32^{\circ}\text{F} < t < t_{\text{saturation}}$ at system pressure

Properly shielded and grounded cables and connectors must be used in order to meet FCC emission limits. Contrec Ltd is not responsible for any radio or television interference caused by using other than recommended cables and connectors or by unauthorized changes or modifications to this equipment. Unauthorized changes or modifications could void the user's authority to operate the equipment.

This device complies with Part 15 of the FCC Rules. Operation is subject to the following two conditions: (1) this device might not cause harmful interference, and (2) this device must accept any interference received, including interference that might cause undesired operation.

Chapter 2

Specifications

Specification Table

<p>Operating Environment</p> <p>Temperature -20°C to +60°C (conformal coating) +5°C to +40°C (no coating)</p> <p>Humidity 0 to 95% non condensing (conformal coating) 5% to 85% non condensing (no coating)</p> <p>Power Supply 100-240 V AC (+/-10%) 50-60 Hz (+/-10%) or 12-28 V DC</p> <p>Consumption 6W (typical)</p> <p>Protection Sealed to IP65 (Nema 4X) when panel mounted</p> <p>Dimensions (panel option) 147mm (5.8") width 74mm (2.9") height 167mm (6.6") depth</p>	<p>Frequency Input (General)</p> <p>Range 0 to 10kHz</p> <p>Overvoltage 30V maximum</p> <p>Update Time 0.3 sec</p> <p>Cutoff frequency Programmable</p> <p>Configuration Pulse, coil or NPS input</p> <p>Non-linearity Up to 10 correction points</p>
<p>Display</p> <p>Type Backlit LCD with 7-digit numeric display and 11-character alphanumeric display</p> <p>Digits 15.5mm (0.6") high</p> <p>Characters 6mm (0.24") high</p> <p>LCD Backup Last data visible for 15min after power down</p> <p>Update Rate 0.3 second</p>	<p>Pulse</p> <p>Signal Type CMOS, TTL, open collector, reed switch</p> <p>Threshold 1.3 volts</p>
<p>Non-volatile Memory</p> <p>Retention > 30 years</p> <p>Data Stored Setup, Totals and Logs</p>	<p>Coil</p> <p>Signal Type Turbine and sine wave</p> <p>Sensitivity 15mV p-p minimum</p>
<p>Approvals</p> <p>Interference CE compliance</p> <p>Enclosure IECEx, ATEX and CSA approved enclosures available for hazardous areas</p>	<p>NPS</p> <p>Signal Type NPS sensor to Namur standard</p>
<p>Real Time Clock (Optional)</p> <p>Battery Type 3 volts Lithium button cell (CR2032)</p> <p>Battery Life 5 years (typical)</p>	<p>Analog Input (General)</p> <p>Overcurrent 100mA absolute maximum rating</p> <p>Update Time < 1.0 sec</p> <p>Configuration RTD, 4-20mA, 0-5V and 1-5V input</p> <p>Non-linearity Up to 20 correction points (some inputs)</p>
	<p>RTD Input</p> <p>Sensor Type PT100 & PT500 to IEC 751</p> <p>Connection Four Wire</p> <p>Range -200°C to 350°C</p> <p>Accuracy 0.1°C typical (-100°C to 300°C)</p>
	<p>4-20mA Input</p> <p>Impedance 100 Ohms (to common signal ground)</p> <p>Accuracy 0.05% full scale (20°C) 0.1% (full temperature range, typical)</p>
	<p>0-5 or 1-5 Volts Input</p> <p>Impedance 10M Ohms (to common signal ground)</p> <p>Accuracy 0.05% full scale (20°C) 0.1% (full temperature range, typical)</p>

Logic Inputs

Signal Type	CMOS, TTL, open collector, reed switch
Oversvoltage	30V maximum

Relay Output

No. of Outputs	2 relays plus 2 optional relays
Voltage	250 volts AC, 30 volts DC maximum (solid state relays use AC only)
Current	3A maximum

Communication Ports

Ports	RS-232 port RS-485 port (optional)
Baud Rate	2400 to 19200 baud
Parity	Odd, even or none
Stop Bits	1 or 2
Data Bits	8
Protocols	ASCII, Modbus RTU, Printer*

Transducer Supply

Voltage	8 to 24 volts DC, programmable
Current	70mA @ 24V, 120mA @ 12V maximum
Protection	Power limited output

Isolated Output

No. of Outputs	1 configurable output (plus 1 optional)
Configuration	Pulse/Digital or 4-20mA output

Pulse/Digital Output

Signal Type	Open collector
Switching	200mA, 30 volts DC maximum
Saturation	0.8 volts maximum
Pulse Width	Programmable: 10, 20, 50, 100, 200 or 500ms

4-20mA Output

Supply	9 to 30 volts DC external
Resolution	0.05% full scale
Accuracy	0.05% full scale (20°C) 0.1% (full temperature range, typical)

*Important: Specifications are subject to change without notice.
Printer protocol is available only if RTC option is installed.*

Chapter 3

Installation

Panel Mounting

The instrument should be located in an area with a clean, dry atmosphere that is also relatively free of shock and vibration.

The standard mounting procedure is panel mounting in a cutout that is 139mm wide by 67mm high. Two side clips secure the unit into the panel.

shows the panel mounting requirements for the 500 Series Instrument.

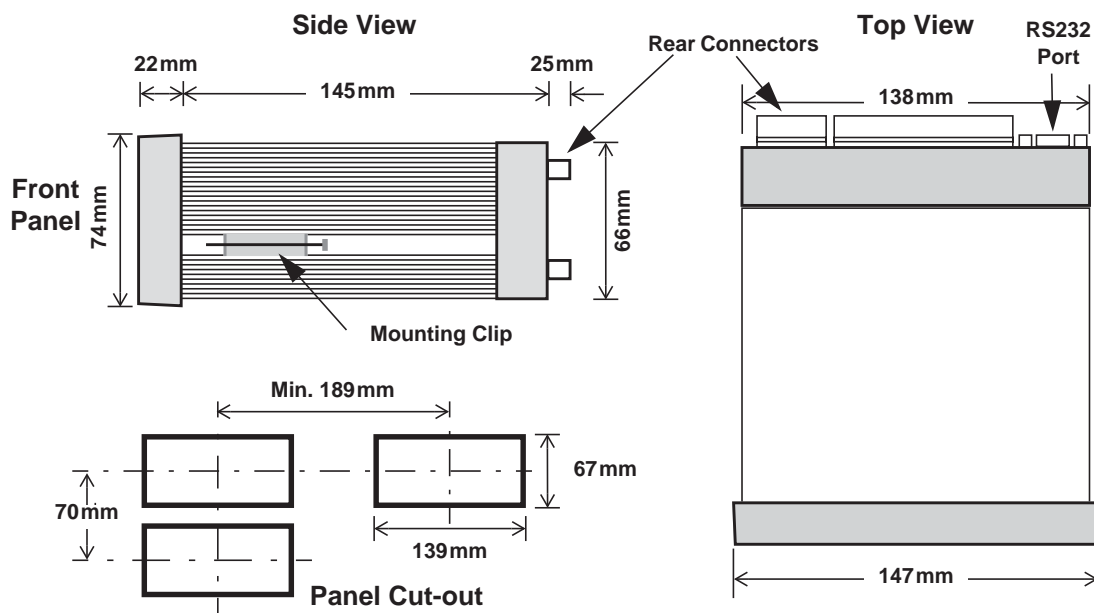

500 Series Instrument Panel Mounting

Electrical Connection

Rear Panel Connections

Figure 2 shows the connections on the rear panel of the instrument.

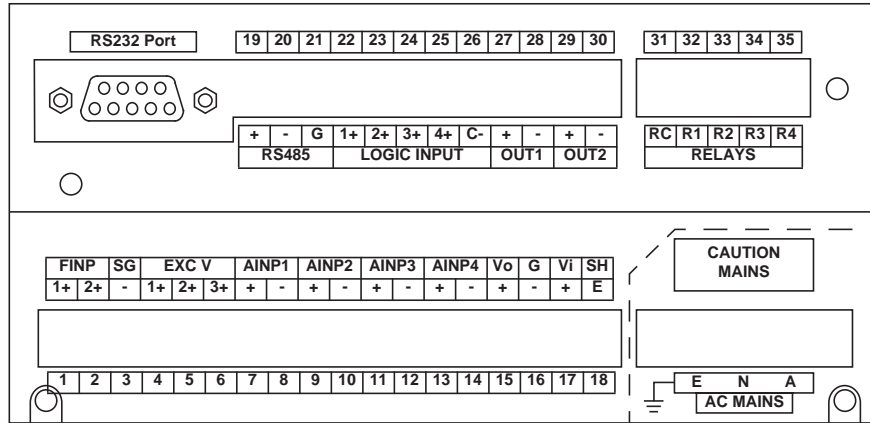

Figure 2 Rear Panel Connections

Terminal Designations

Terminal Label	Designation	Comment	Terminal Label	Designation	Comment
1	FINP 1+	Frequency Input 1+	19	+	RS485 (+)
2	FINP 2+	Frequency Input 2+	20	-	RS485 (-)
3	SG -	Signal ground	21	G	RS485 ground
4	EXC V 1+	Excitation Term 1+	22	1+	Switch 1
5	EXC V 2+	Excitation Term 2+	23	2+	Switch 2
6	EXC V 3+	Excitation Term 3+	24	3+	Switch 3
7	AINP1 +	Analog Input ch 1 (+)	25	4+	Switch 4
8	AINP1 -	Analog Input ch 1 (-)	26	C-	Signal ground
9	AINP2 +	Analog Input ch 2 (+)	27	+	Output ch 1 (+)
10	AINP2 -	Analog Input ch 2 (-)	28	-	Output ch 1 (-)
11	AINP3 +	Analog Input ch 3 (+)	29	+	Output ch 2 (+)
12	AINP3 -	Analog Input ch 3 (-)	30	-	Output ch 2 (-)
13	AINP4 +	Analog Input ch 4 (+)	31	RC	Relay common
14	AINP4 -	Analog Input ch 4 (-)	32	R1	Relay 1
15	Vo +	8-24 volts DC output	33	R2	Relay 2
16	G -	DC Ground	34	R3	Relay 3
17	Vi +	DC power input	35	R4	Relay 4
18	SH E	Shield terminal	RELAYS		Optional relays
E	AC MAINS E	Mains ground	RS232 port		9-pin serial port
N	AC MAINS N	Mains neutral			
A	AC MAINS A	Mains active			

Inputs

Frequency Input Connection

Connect pulse or frequency input signals from devices such as: TTL, CMOS, open collector, reed relay switch, coil and Namur proximity switch, as shown below. For better signal integrity, it is recommended to use shielded cable. Refer to **Terminal Designations** on page 12 for specific terminal numbers for this application.

Squarewave, CMOS or TTL

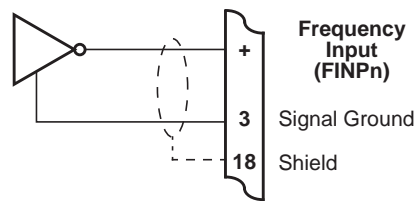

Open Collector

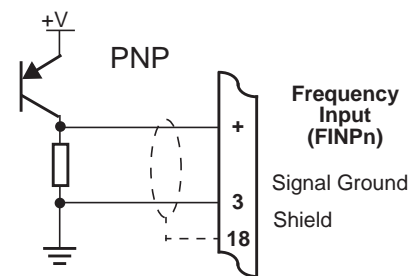
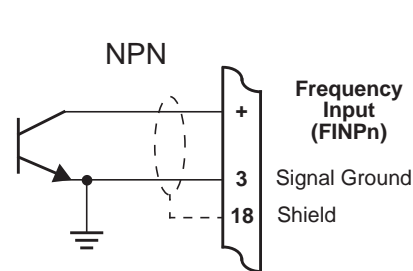

Reed Relay Switch

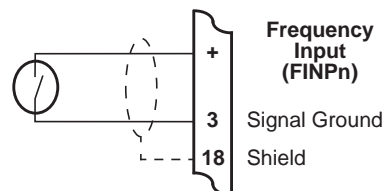

Coils - with 15 millivolts peak to peak AC minimum

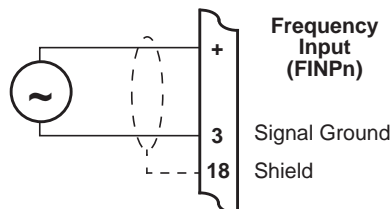

Namur Proximity Switch

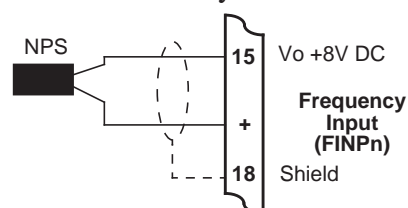

Analog Input Connections

All analog inputs can accept DC signals ranging from 0-5V, 1-5V and current signals from 4 to 20mA.

Analog Inputs 1 and 2 (AINP1 / AINP2) can also accept an RTD input (PT100 or PT500) as well as the standard 0-5V, 1-5V and 4 to 20mA input.

CAUTION

Applying levels of input current above the absolute maximum rating (100mA) may cause permanent damage to the input circuitry.

0-5 and 1-5 Volt Inputs

For externally powered voltage transmitters, connect each transmitter to a pair of input terminals as shown in Figure 3. Refer to **Terminal Designations** on page 12 for specific terminal numbers for this application.

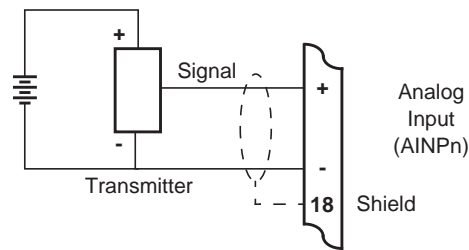

Figure 3 Externally Powered Voltage Transmitter

Connect internally powered voltage transmitters as shown in Figure 4.

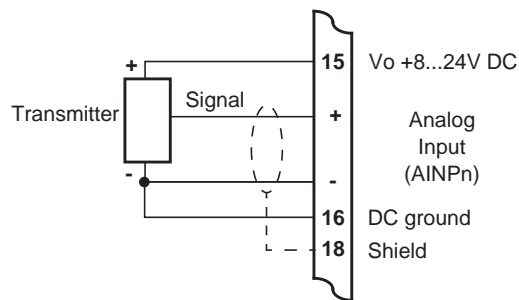

Figure 4 Internally Powered Voltage Transmitter

4-20mA Inputs

For an externally powered current loop, connect the transmitter to the input terminals as shown in Figure 5. Refer to **Terminal Designations** on page 12 for specific terminal numbers for this application.

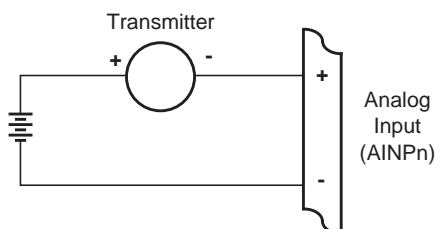
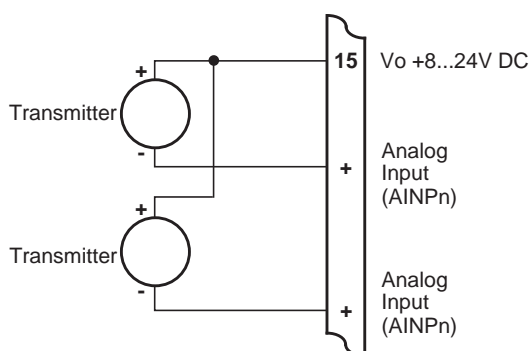

Figure 5 Externally Powered Current Loop

The internal overload-protected power supply has sufficient power for three current loops at 24 V DC (more current loops can be supplied by using a reduced voltage setting). Connect internally powered current loops as shown in Figure 6.

Figure 6 Internally Powered Current Loops



RTD Input

The instrument uses 4-wire RTDs to provide optimum accuracy and stability. It is not necessary to have equal cable lengths for the 4-wire RTDs, but they should be no longer than 50 metres. It is also recommended to use shielded twisted pairs.

Connect RTD inputs as shown in Figure 7.

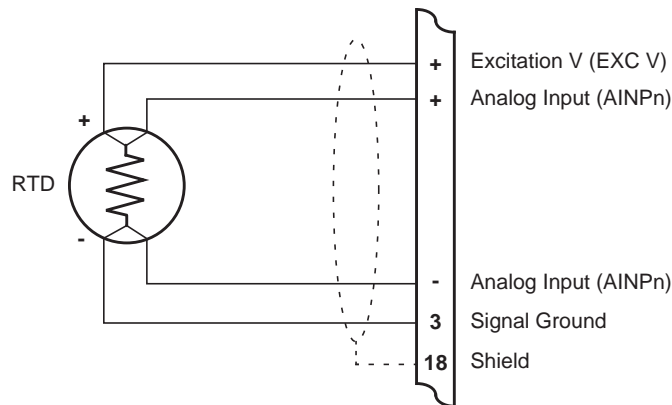

Figure 7 RTD Connection

Analog Inputs 1 and 2 (AINP1 / AINP2) are available for RTD connection.

Excitation terminal 2 (pin 5) must be used in conjunction with AINP1.

Excitation terminal 3 (pin 6) must be used in conjunction with AINP2.

It is possible to use two-wire or three-wire RTDs. However, four wires must be taken to the RTD, with the signal and current wires joined as close to the RTD as possible.

Note: The RTD has no polarity and can be connected in either direction. However, the excitation and the positive analog input must be connected to one side of the RTD. Similarly, the Signal Ground and the negative analog input must be connected to the other side of the RTD.

Logic Input Connection

These input(s) are designed to be connected to CMOS, TTL, open collector signals or a voltage free contact switch. A minimum activation time of 300ms is required to guarantee reading of an input.

It is possible to read the status of all the logic inputs via a Modbus register even if they are not used for a control purpose in the application.

A remote push-button key can be connected to the Logic Inputs as shown below.

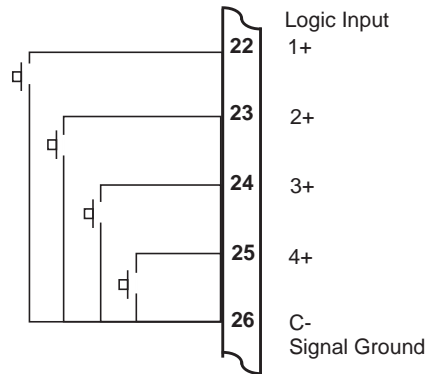

Figure 8 Logic Inputs Connection Diagram

Outputs

The advanced option for the instrument provides two opto-isolated output ports. Either or both can be used for 4-20mA or pulse outputs.

CAUTION

Due to the dual-purpose nature of the outputs, take care not to set the output as an open collector pulse type signal when connected to a 4-20mA loop circuit.

4-20mA Output Connection

Figure 9 shows the connections for a 4-20mA output. Output channel 1 uses terminals 27 (+) and 28 (-), output channel 2 uses terminals 29 (+) and 30 (-).

Maximum Load Resistance = (Supply-9) / 0.02 ohms

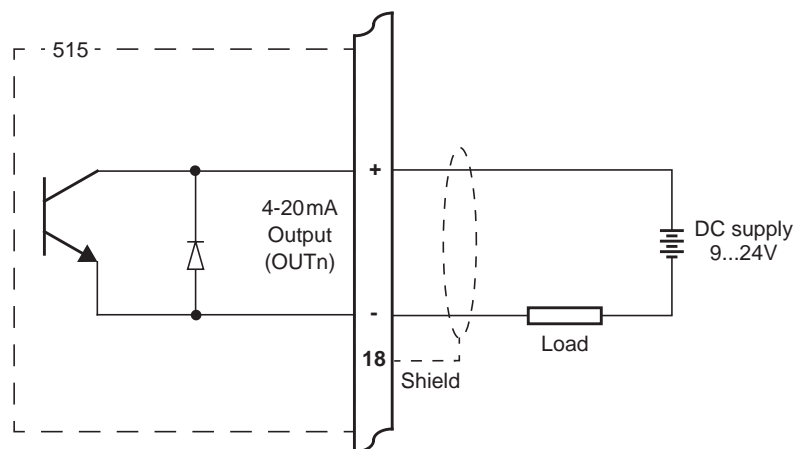

Figure 9 Output 4-20mA Connection Diagram

Pulse Output Connection

Figure 10 shows a connection example for a pulse output. Output channel 1 uses terminals 27 (+) and 28 (-). Output channel 2 uses terminals 29 (+) and 30 (-).

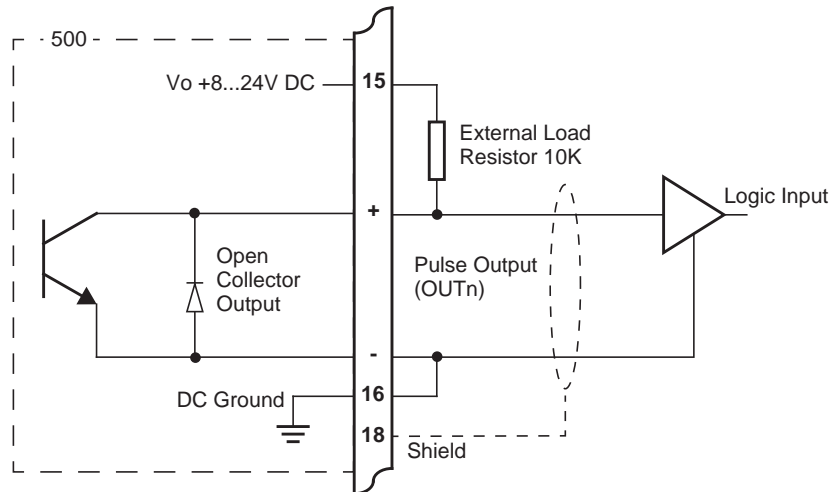

Figure 10 Output Pulse Connection Diagram

Control Relays (Alarms)

The standard instrument has two alarm relays, which can be used to drive external devices such as external relays, LEDs, and audible alarms. The advanced option has four alarm relays.

The operation of each alarm relay can be set to various modes as described in [Alarms](#) on page 42.

There is also an equipment failure alarm option. This alarm can have normally closed (open) contacts which open (close) when the instrument displays any error message as listed in [Error Messages](#) on page 51, or if there is a loss of power to the instrument.

The output characteristics of the relays are:

Maximum Voltage 30 volts DC or 250 volts AC
Maximum Current 3 A

Note: Solid state relays use AC voltage only.

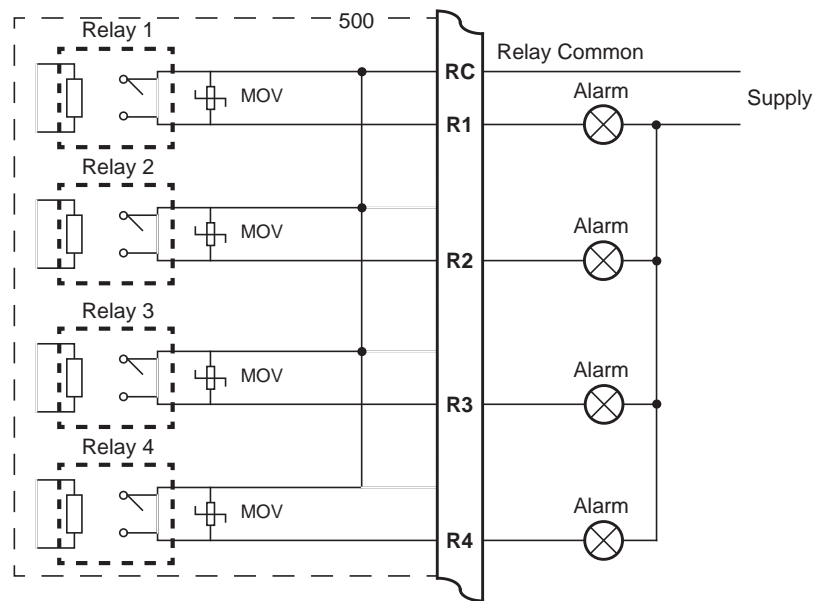

Figure 11 Relay Connection Diagram

RC Network for Interference Suppression

When driving highly inductive loads with the relay outputs, it is recommended to use RC suppression networks (often called “Snubbers”) for the following reasons:

- To limit the amount of electrical noise caused by arcing across the contacts, which may, in extreme cases, cause the microprocessor to act erratically.
- To protect the relay contacts against premature wear through pitting.

RC suppression networks consist of a capacitor and series resistor and are commonly available in the electrical industry. The values of R and C are dependent entirely on the load. However, if the user is unsure of the type of snubber to use, values of $0.25\mu\text{F}$ and 100Ω will usually suffice. Note that only mains-approved RC suppression networks should be used.

The basic principle of the operation is that the capacitor prevents a series of sparks arcing across the contact as the contact breaks. The series resistor limits the current through the contact when the contact first makes.

Communications

The communication protocols are described in [Protocols](#) on page 55.

RS-232 Port

The RS-232 port has a 9-pin DB female connector and has the following pinout:

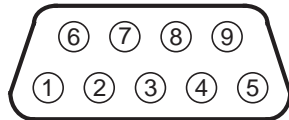

Pin 1	Not used
Pin 2	Transmit (TxD)
Pin 3	Receive (RxD)
Pin 4	Not used
Pin 5	Ground
Pin 6	Not used
Pin 7	Handshake line (CTS)
Pin 8	RTS Out
Pin 9	Not used

Note: The instrument does not require a null-modem cable for connection to a personal computer. Refer to [Hardware Interconnection](#) on page 53 for cable termination requirements.

RS-485 Port (Optional)

Up to 32 units can be connected to a common RS-485 bus. Each unit has a unique address that the host computer uses to identify each instrument.

Figure 12 shows the connection of several instruments to a computer using the RS-485 port.

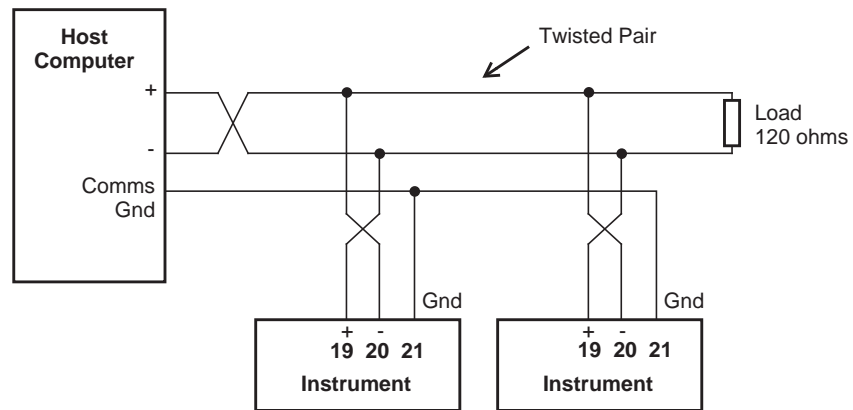

Figure 12 RS-485 Interface Connections

Earthing and Shielding

It is a good practice to use shielded cable for all signal connections to the instrument. Care must be taken to separate signal cables from power cables to minimize interference.

Overall earth should be connected at the instrument end only. This connection should be as short as possible and connected to the earthing point on the rear terminal at pin 18.

Chapter 4

Operation

Normal Operation

In normal operation mode, you press the buttons on the front panel to display the values recorded and calculated by the instrument. There are four categories of information that the instrument can display:

- Totals
- Rates
- Process variables
- Instrument settings

For each total, there is an associated rate as follows:

Total	Rate
Energy	Power
Volume	Volume Flowrate
Mass	Mass Flowrate

Default Total

In some applications, one set of variables is of more interest than others, and for this reason a default total and its associated rate can be assigned during instrument calibration. This default total can be used in two ways:

- The default variables come first in the sequence of totals and rates that are displayed with the front panel keys.
- If the display timeout option is enabled and no buttons are pressed for the selected period (usually 30 seconds) the display returns to the default total.

Status LEDs

The status LEDs illuminate to show the following conditions:



- Run** The host computer is downloading the application software.
- Set** The instrument is in Calibrate Set mode.
- Alarm** The instrument has an error, as indicated on the display panel.
- Cal** The instrument is in Calibrate View mode.

Front Panel Keys

For most actions with the front panel keys, you can hold a key to scroll through the values or options, instead of repeatedly pressing the key.

RATE Press the **RATE** key to display the rate that is associated with the currently displayed total. If an item other than a rate or total is displayed, press the **RATE** key to display the “default rate”. When a rate is displayed, press or hold the **RATE** key to display the other rate variables in turn.

TOTAL Press the **TOTAL** key to display the total that is associated with the currently displayed rate. If an item other than a rate or total is displayed, press the **TOTAL** key to display the “default total”. When a total is displayed, press or hold the **TOTAL** key to display the other total variables in turn.

RESET Use the **RESET** key to clear all resettable totals or to initiate a printout if the printer option has been selected. The printout is activated with a single press while the Total Reset function has different operation modes that are selectable during instrument calibration as follows:

- NONE - The user cannot reset the non-accumulated totals.
- INSTANT - When the user presses the **RESET** key, the instrument resets all non-accumulated totals.
- DELAYED - When the user holds the **RESET** key for two seconds, the instrument resets all non-accumulated totals.

The instrument makes three beeps when it resets the totals and two beeps when a printout is started.

DISPLAY Press the **DISPLAY** key to step or scroll through the main menu items.

ACCUM Hold the **ACCUM** key to display the accumulated value for the currently displayed total or to display the peak value for the currently displayed flowrate. See below for further details of peak flowrates.

Main Menu Items

The main menu in this instrument consists of the following items. The **DISPLAY** key is used to step or scroll through the list.

DISPLAY ↓	Description	Options
ENERGY	Energy content	Hold the ACCUM key to display accumulated total
POWER	Power (energy flowrate)	Hold the ACCUM key to display peak value
VOLUME	Volume	Hold the ACCUM key to display accumulated total
V-FLOW	Volume flowrate	Hold the ACCUM key to display peak value
MASS	Mass	Hold the ACCUM key to display accumulated total

<div style="border: 1px solid black; padding: 2px; display: inline-block;">DISPLAY</div> ↓	Description	Options
M-FLOW	Mass flowrate	Hold the ACCUM key to display peak value
TEMP-F	Feed Temperature	
TEMP-R	Return Temperature	
TEMP-D	Differential temperature	
REPORT PRINT	Only shown if print option is selected	Hold the SET key to print log report as defined in the TM/LOG section of calibration.
LOGGED DATA	Only shown if real-time clock option is installed	Hold the SET key to display data logs as described in Data Logs on page 25.
MODEL INFO		Hold the SET key to display the Model information as described in Model Information on page 28.
CAL MENU		Hold the SET key to enter Calibration View mode as described in Calibration View Mode on page 29.

Peak Flowrates

The peak value for the currently displayed flowrate can be viewed by holding the **ACCUM** key. The peak value is the average over a 15 minute period since the last reset of totals or powering on of the instrument. Dashes are shown for this value after a reset or power on until the first averaging period has passed.

Data Logs

The instrument will log the main-menu variables if real-time clock option is installed. The logs are at fixed intervals of hours, days, weeks, months and years. The instrument can store a total of more than 1000 log entries.

If the number of log entries exceeds the programmed number for a particular time interval, the oldest log entry is overwritten by the newest one for that time interval.

Also note that the totals are saved as accumulated totals.

The log entries are recorded at the following times:

HOUR	00 minutes each hour
DAY	00 hours and 00 minutes each day
WEEK	00 hours and 00 minutes each Monday
MONTH	00 hours and 00 minutes on the first day of the month
YEAR	00 hours and 00 minutes on the first day of the year.

View Data Logs

Use the following procedure to view the data that has been logged by the instrument:

1. Press the **DISPLAY** key to scroll through the menu to the **LOGGED DATA** prompt.
2. Hold the **SET** key.

The system displays the hourly log. The timebase and number of the log are shown, for example LH-001.

3. While holding the **DISPLAY** key use the **RESET** key to print the data for the displayed log if the printer option has been selected.

The following example shows the hourly log number 006 at 15:00 (3:00 pm) on 16 January 2016. The day and month alternate with the year in the bottom right hand corner.

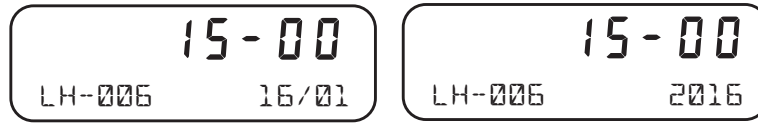

Figure 13 shows how to display the logged data.

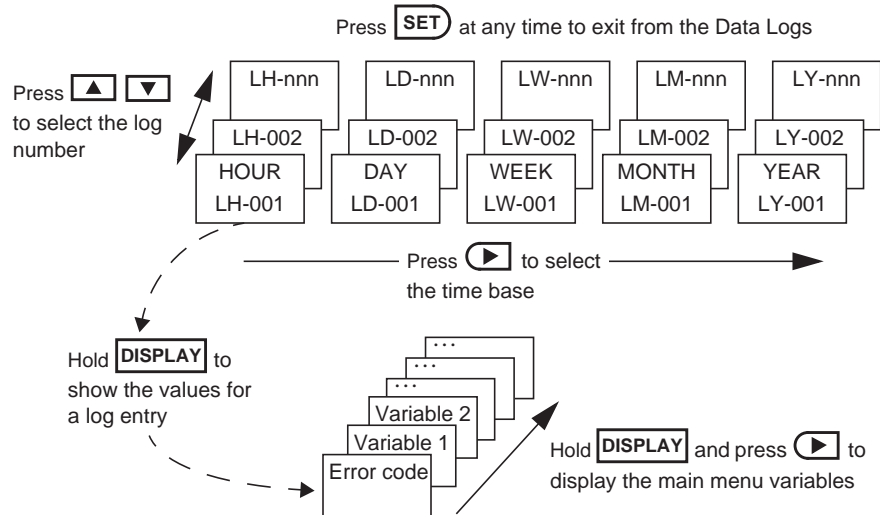

Figure 13 Logged Data Display Methods

Model Information

The model information items display the hardware, software and application versions of the instrument. This information is mainly for service personnel.

<div style="border: 1px solid black; padding: 2px;">DISPLAY</div> ↓	Description
2-1--5- 515 MODEL	The hardware model code. Refer to Product Codes on page 73 for more information.
F-EE-- HC01 INPUT	The Application number and the assignment of the inputs. Refer to Application Information Code on page 74 for more information.
3.0.000 500PM VERS	The version of 500-Series Program Manager from which the application software was compiled.
026357 CUSTOM VERS	The Customer version code for this installation. Refer to Custom Version Codes on page 74 for more information.
123456 ABC123 S/N	The instrument serial number and unit tag. The serial number is on the top line and unit tag is on the bottom left. Both items are entered when the instrument application software is initially loaded. If the unit tag is not used the default tag, UNIT, will be used.
16-15 EDITED 27/08 2016	<p>The time and date when the calibration of the instrument was last edited. The format of the time and date is the same as for the data logs. This example shows 16:15 (4:15pm) on the 27th August 2016.</p> <p>This function is available only if the instrument has the real time clock option.</p>

Press SET at any time to exit from the Model information.

Chapter 5

Instrument Calibration

Introduction

You can view or change the settings of the instrument according to the access level for each parameter as set by the manufacturer. There are four levels of access to the parameters as follows:

- **Not visible** - you cannot display or edit the parameter.
- **Display Only** - you can display the parameter, but you cannot change the setting.
- **Programmable** - you can change the setting of the parameter in Calibration Set mode.
- **Password protected** - you can change the setting of the parameter in Calibration Set mode only if you enter the correct password.

Note: When you enter Calibration Set mode, the instrument requests you to enter a password. Any value will allow to change the settings of the “programmable” parameters, but the correct password must be entered to change the password-protected parameters.

Calibration View Mode

Use the following procedure to view the calibration settings of the instrument:

1. Press **DISPLAY** to scroll to the **CFM MENU** prompt.
2. Hold the **SET** key.



The instrument beeps once, illuminates the **Cal** indicator and shows **CFM** on the display panel.

- Press **▶** to scroll through the flashing menu headings.
 - Press **SET** to scroll through submenu items.
 - Press **DISPLAY** to return to the main calibration menu.
3. To exit from the Calibration View mode, press **▶** to scroll to the **END** option and press **SET**.

The instrument returns to Normal Operation mode.

Calibration Set Mode

In Calibration Set mode, you can change the settings of the “programmable” parameters. You must enter the system password to change the setting of the “password-protected” parameters.

Use the following procedure to enter Calibration Set mode:

1. Press **DISPLAY** to scroll to the **FL MENU** prompt.

2. Hold the **SET** key.



The instrument beeps once, illuminates the **Cal** indicator and shows **FL** on the display panel.

3. Press **▶** to select any flashing menu heading except **END**.

4. Hold **SET** for two seconds.

The instrument requests a password.

5. Press **▲** or **▼** to change the value of the current digit. To select the next digit, press **▶**.

6. Press **SET** to accept the password.

- The instrument makes two beeps for a correct password entry and enables you to change the “programmable” and “password-protected” parameters.
- The instrument makes one beep for an incorrect password entry and enables you to change only the “programmable” parameters.



The instrument illuminates both the **Cal** and **Set** indicators.

7. Edit the instrument parameters as required. The programmable values are indicated by the flashing display.

- To change a numerical value, press **▲** to increase a value, or press **▼** to decrease a value. Press a key momentarily to change the value one number at a time. Hold a key to scroll through the numbers. To proceed to next digit, press **▶**.
- To change an option setting, press **▲** or **▼** to scroll through the options.

8. Press **SET** to accept the currently displayed value and proceed to the next parameter. You can press **DISPLAY** to return to the main calibration menu.

9. To exit from Calibrate Set mode, press **▶** to scroll through the main calibration menu to **END**, then press **SET**. Otherwise, from any menu, you can press and hold **SET** for two seconds.





The instrument makes two beeps and cancels the **Cal** and **Set** indicators.

Changing the Instrument Settings

In Calibration Set mode, the display flashes the item that can be changed. For option settings, the display flashes the complete option. For a numeric parameter, the display flashes one digit at a time, you can change the value of the flashing digit as required, then move the flashing cursor to change another digit.

Note: When you change the setting of a parameter, the instrument records the result as soon as you move to another parameter, or exit from the Calibration Set mode.

Changing Option Settings

When you display an option that can be changed, the entire option flashes on the display, such as the choices of ODD, EVEN or NONE for the communications parity bit checking. Press  or  to change the option. You can “scroll” through the options in either direction to make a selection as shown below.

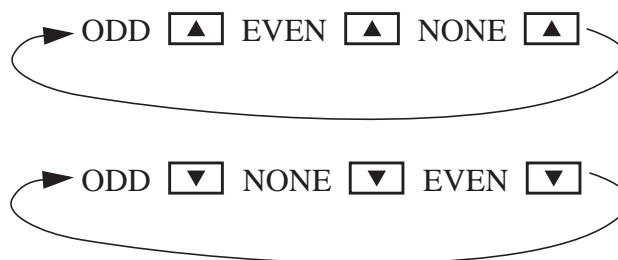

Changing Numeric Settings



The display flashes the digit that can be changed.



Press  to select the digit that you wish to change.

Press  or  to increase or decrease the value of the selected digit.

Changing the Decimal Point

To change the position of the decimal point, press  to move the flashing selection until the decimal point flashes. Press  or  to move the decimal point to the right or left as required.

Units of Measurement

The calibration of some parameters is based on the units that are defined for the relevant variables. These units of measurement can be viewed in the UNITS menu in calibration below.

Calibration Menu Tree

Figure 14 and Figure 15 show the keys for moving around the calibration menu tree in Calibration View or Set mode.

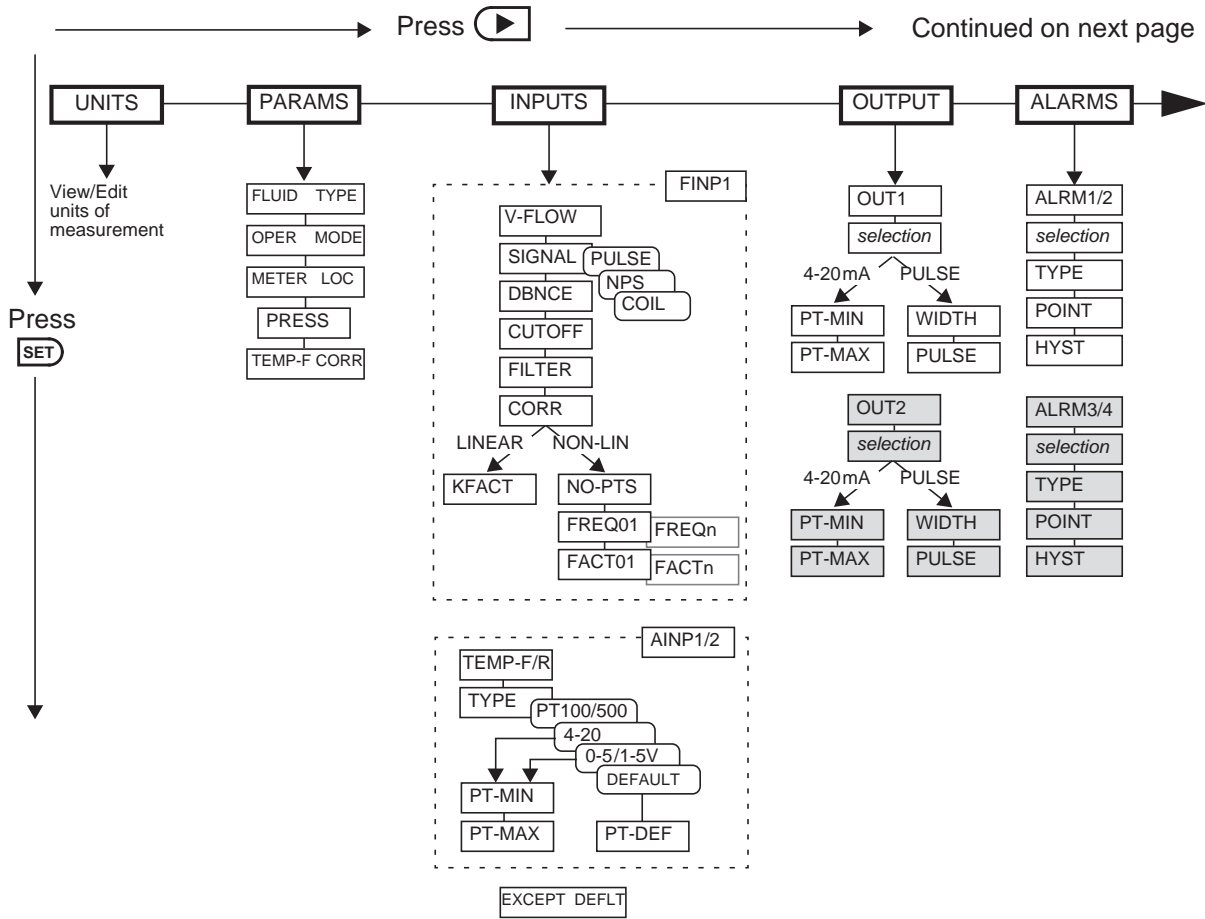
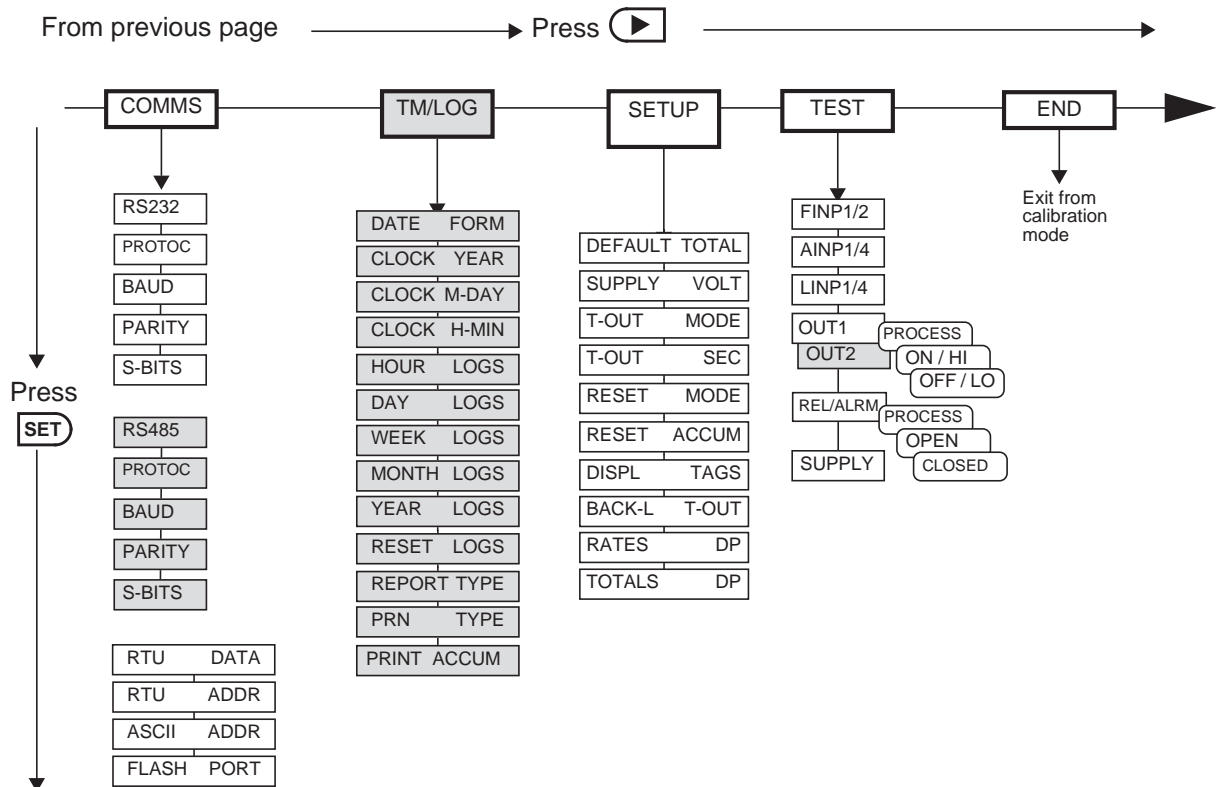

Figure 14 Calibration Menu Tree Sheet 1



 The shaded boxes indicate hardware options

Press  at any point to return to the main calibration menu.



Press  at any I/O assignment position to move to the next I/O assignment in the submenu (eg pressing  on ALRM1 will move you to ALRM2 if it exists)

Figure 15 Calibration Menu Tree Sheet 2

Instrument Settings

Units of Measurement

The Units menu allows the units to be viewed and edited if necessary without the reloading of new application software. Any change in units will result in a full reset to initially downloaded settings. Therefore, any required changes to units of measurement should be made before changing any other settings.

<p>SET ↓</p>	<p>▶ → UNITS PARAMS INPUTS OUTPUTS ALARMS COMMS TM/LOG SETUP TEST END</p>
<p>ITEM <i>n</i> <i>unit</i></p>	<p>The units for main menu or calibration items can be viewed by pressing the SET key.</p> <p>The units of measurement are password protected. To edit the units the correct password must be entered on entry to EDIT mode.</p> <p>Press ▲ or ▼ to select the required units. Refer to Available Units of Measurement on page 76 for the list of available units.</p>
<p>ACCEPT UNITS</p>	<p>The Accept Units prompt will only appear if one or more of the units have been changed.</p> <p>IMPORTANT: Accepting the change of units will initiate a master reset. All calibration parameters will revert to their default value (i.e. those values included in the downloaded instrument software). All totals and any logged information will be cleared.</p> <p>Press ▲ or ▼ to select YES, then press the SET key. The instrument makes three beeps to confirm the reset command.</p> <p>The message -RESET- PLEASE WAIT will be displayed as the instrument exits calibration mode and completes a full re-boot sequence.</p>

Parameters

SET ↓	▶ → UNITS PARAMS INPUTS OUTPUTS ALARMS COMMS TM/LOG SETUP TEST END
FLUID TYPE	<p>Select a fluid type from the following list of commonly used in heating and cooling systems. The instrument will for all fluids, other than Default (water), use internal “Enthalpy & Density vs Temperature” tables to determine the energy and mass of the fluid.</p> <ul style="list-style-type: none"> • DEFAULT - Water using IAPWS-97 • GLYCOL - 35% Glycol solution • BRINE - 27% CaCl₂ solution • F20 - TYFOXIT F20 • F40 - TYFOXIT F40 • OIL-T - Essotherm 500 / Thermaloil T • TH-55 - THERMINOL 55 • USER - Uses custom Temperature vs Density & Enthalpy table (This table is constructed and downloaded from the 500 Series Program Manager). <p>Press ▲ or ▼ to select one of the options.</p>
OPER MODE	<p>The operation mode allows an instrument to be configured for heating and/or cooling applications.</p> <ul style="list-style-type: none"> • HEAT - Heating mode only calculates energy while feed temperature is higher than return temperature. • COOL - Cooling mode only calculates energy while feed temperature is lower than return temperature. • BOTH - Continues to calculate energy regardless of whether the differential temperature is positive or negative. <p>Select the operation mode as required.</p> <p>Press ▲ or ▼ to select one of the options.</p>
METER LOC	<p>Enter the flowmeter location as being in either the feed or return line.</p> <p>Press ▲ or ▼ to select FEED or RETURN.</p>

SET ↓	▶ → UNITS PARAMS INPUTS OUTPUTS ALARMS COMMS TM/LOG SETUP TEST END
PRESS <i>unit</i>	<p><i>This parameter is available for viewing and editing only when the fluid type is set to DEFAULT (water).</i></p> <p>Enter the system absolute pressure used to provide greater accuracy of calculations for high pressure applications.</p>
TEMP-F CORR	The feed temperature correction can be used for fine-tuning of measurement. This parameter is added to the feed temperature and is mainly used in cooling systems with RTD temperature sensors.

Inputs

SET ↓	▶ → UNITS PARAMS INPUTS OUTPUTS ALARMS COMMS TM/LOG SETUP TEST END
Frequency Input 1	
INPUT FLOW FINP	For this application, Frequency Input is assigned to volume flowrate.
SIGNAL FINP1	<p>Frequency input 1 signal type.</p> <p>Press ▲ or ▼ to select COIL, NPS or PULSE.</p>
BUNCE FINP1	<p>Switches and relays have metal contacts to make and break circuits. The contact bounce introduces random signals into the circuit. The instrument has a debounce circuit to eliminate this problem.</p> <p>Note: When the debounce circuit is enabled, the maximum input frequency for large amplitude signals is limited to approximately 500Hz. For low amplitude signals, the maximum frequency can be approximately 200Hz.</p> <p>Press ▲ or ▼ to select ENABLE or DISABLE.</p>
CUTOFF FINP1	<p>The Cut-off is the lowest frequency for which the instrument continues to calculate a rate from the flowmeter.</p> <p>The value for the cut-off is specified as the frequency of the flowmeter in Hertz.</p> <p>Be careful when setting low cut-off values because the display update time for the flow rate becomes very long. For example if the cut-off is set to 0.01 Hz, and the measured flow stops, the instrument continues to display the flow rate for 100 seconds before it can determine that the flow has actually stopped.</p>

SET ↓	▶ → UNITS PARAMS INPUTS OUTPUTS ALARMS COMMS TM/LOG SETUP TEST END																																													
FILTER FINP1	<p>Input fluctuations caused by pulsating flow tend to create distortion in the input readings of the rate. The instrument has a digital filter that averages out these fluctuations.</p> <p>As a guide to the degree of filtering to use, the following table shows the response time (in seconds) to reach 90% and 99% of a step change in input.</p> <p>The value A is the filter constant that the user can set.</p> <table border="1" style="width: 100%; border-collapse: collapse;"> <thead> <tr> <th style="text-align: center;">Filter setting A</th> <th style="text-align: center;">Seconds to reach 90% of full swing</th> <th style="text-align: center;">Seconds to reach 99% of full swing</th> </tr> </thead> <tbody> <tr><td style="text-align: center;">0</td><td style="text-align: center;">0</td><td style="text-align: center;">0</td></tr> <tr><td style="text-align: center;">2</td><td style="text-align: center;">2</td><td style="text-align: center;">4</td></tr> <tr><td style="text-align: center;">4</td><td style="text-align: center;">4</td><td style="text-align: center;">8</td></tr> <tr><td style="text-align: center;">6</td><td style="text-align: center;">5</td><td style="text-align: center;">10</td></tr> <tr><td style="text-align: center;">10</td><td style="text-align: center;">8</td><td style="text-align: center;">15</td></tr> <tr><td style="text-align: center;">15</td><td style="text-align: center;">12</td><td style="text-align: center;">23</td></tr> <tr><td style="text-align: center;">20</td><td style="text-align: center;">14</td><td style="text-align: center;">27</td></tr> <tr><td style="text-align: center;">25</td><td style="text-align: center;">18</td><td style="text-align: center;">34</td></tr> <tr><td style="text-align: center;">35</td><td style="text-align: center;">25</td><td style="text-align: center;">48</td></tr> <tr><td style="text-align: center;">45</td><td style="text-align: center;">32</td><td style="text-align: center;">62</td></tr> <tr><td style="text-align: center;">60</td><td style="text-align: center;">42</td><td style="text-align: center;">82</td></tr> <tr><td style="text-align: center;">75</td><td style="text-align: center;">52</td><td style="text-align: center;">102</td></tr> <tr><td style="text-align: center;">90</td><td style="text-align: center;">62</td><td style="text-align: center;">122</td></tr> <tr><td style="text-align: center;">99</td><td style="text-align: center;">68</td><td style="text-align: center;">134</td></tr> </tbody> </table> <p>The input filter range is from 0 to 99. A setting of 0 (zero) means that there is no filtering.</p>	Filter setting A	Seconds to reach 90% of full swing	Seconds to reach 99% of full swing	0	0	0	2	2	4	4	4	8	6	5	10	10	8	15	15	12	23	20	14	27	25	18	34	35	25	48	45	32	62	60	42	82	75	52	102	90	62	122	99	68	134
Filter setting A	Seconds to reach 90% of full swing	Seconds to reach 99% of full swing																																												
0	0	0																																												
2	2	4																																												
4	4	8																																												
6	5	10																																												
10	8	15																																												
15	12	23																																												
20	14	27																																												
25	18	34																																												
35	25	48																																												
45	32	62																																												
60	42	82																																												
75	52	102																																												
90	62	122																																												
99	68	134																																												
CORR FINP1	<p>If the input sensor has non-linear characteristics, select NON-LINEAR to apply correction factors to the input signal.</p> <p>Use <input type="checkbox"/> ▲ or <input type="checkbox"/> ▼ to select LINEAR or NON-LINEAR.</p>																																													
KFAC T <i>unit</i>	<p><i>This parameter is available for viewing and editing only when the correction type is set to Linear.</i></p> <p>The K-factor of the flowmeter is the number of pulses from the flowmeter per unit of volume (or mass). The K-factor cannot be 0 (zero).</p>																																													

<p>SET ↓</p>	<p>▶ → UNITS PARAMS INPUTS OUTPUTS ALARMS COMMS TM/LOG SETUP TEST END</p>
<p>NO-PTS FINP1</p>	<p><i>This parameter is available for viewing and editing only when the correction type is set to Non-linear.</i></p> <p>Enter the number of non-linearity correction points.</p> <p>Press ▲ or ▼ to select a number between 1 and 10 for the number of correction points.</p>
<p>FREQ01 FINP to FREQn</p>	<p><i>This parameter is available for viewing and editing only when the correction type is set to Non-linear.</i></p> <p>Enter the frequency for this correction point.</p> <p>The instrument uses linear interpolation between the correction points except that the correction factor for FREQ01 is used from 0Hz up to FREQ01. Similarly, the instrument maintains the correction factor for the highest frequency setting up to the maximum input frequency.</p> <p>The following diagram shows the scaling factors at different frequencies for a hypothetical flowmeter. The heavy black line represents the actual scaling factor of the flowmeter. The light black line is the approximation that the instrument uses.</p> <p>Enter the lowest correction factor frequency as FREQ01 and proceed up to the highest frequency. You can press the DISPLAY key to skip the non-linear points and go to the next item.</p>

SET ↓	▶ → UNITS PARAMS INPUTS OUTPUTS ALARMS COMMS TM/LOG SETUP TEST END
FACT01 FINP to FACTn	<p><i>This parameter is available for viewing and editing only when the correction type is set to Non-linear.</i></p> <p>Enter the scaling factor for this correction point in the same units of measure as the single K-factor above.</p> <p>The correction factor cannot be 0 (zero).</p>
Analog Input 1/2	
INPUT TEMP-F AINP1 TEMP-R AINP2	For this application, Analog Input Channels 1 and 2 are assigned to Temperature. Channel 1 is for measuring the feed-line temperature and channel 2 is for the return-line temperature.
TYPE AINP1 AINP2	<p>Select the type of analog input source.</p> <p>Press ▲ or ▼ to select 0-5V, 1-5V, 4-20mA, PT100, PT500 or DEFAULT.</p>
PT-DEF AINP1 AINP2	<p>The Default Point is a fixed value that the instrument uses when the Input Type is set to DEFAULT or Default Value On Exception has been chosen. You can use the Default value instead of a sensor signal for testing purposes, or if the sensor is faulty.</p> <p>You can set the Default value during instrument commissioning so that it is available immediately if you select the Default input type at a later date.</p> <p>Enter the value in the engineering units of assigned variable.</p>

SET ↓	▶ → UNITS PARAMS INPUTS OUTPUTS ALARMS COMMS TM/LOG SETUP TEST END
PT-MIN AINP1 PT-MAX	<i>The Minimum Point and Maximum Point parameters are only for 0-5V, 1-5V and 4-20mA inputs.</i>
PT-MIN AINP2 PT-MAX	<p>Enter the value of the measured parameter that corresponds to the minimum input signal level. The minimum point is commonly referred to as the base value.</p> <p>Enter the value of the measured parameter that corresponds to the maximum input signal level. The maximum point is the same as the base value (set at the minimum point) plus the span value.</p> <p>For example, if the source signal is 4mA for a temperature of 10°C, enter 10 for the minimum point. If the source signal is 20mA for a temperature of 2000°C, enter 2000 as the maximum point.</p>
EXCEPT DEFLT	<p>If Default Value On Exception is enabled the instrument will use the default value for the analog input that raised the exception. This will allow calculations to continue, however the exception message will continue to be displayed until the error is rectified or the input type is set to DEFAULT in calibration set mode.</p> <p>Press ▲ or ▼ to select ENABLE or DISABLE.</p>

Outputs

SET ↓	▶ → UNITS PARAMS INPUTS OUTPUTS ALARMS COMMS TM/LOG SETUP TEST END
PULSE OUTn or 4-20	<p>You can assign any of the “main menu” variables to an output. The nature of the output depends on the assigned variable. Totals are output as pulses and rates are output as 4-20mA passive signals.</p> <p>Press ▲ or ▼ to select the variable that is required as an output. The top of the display shows the type of output signal that is assigned to the variable.</p> <p style="text-align: center;">CAUTION</p> <p style="text-align: center;">Due to the dual-purpose nature of the outputs, take care not to set the output as an open collector pulse type signal when connected to a 4-20mA loop circuit.</p>
WIDTH OUTn	<p><i>The Output Pulse Width is available for viewing and editing only when the assigned variable is a total (pulse output) type.</i></p> <p>Pulse output is usually used to drive remote counters. Set the pulse width (in milliseconds) as required by the remote counter.</p> <p>Press ▲ or ▼ to set to: 10, 20, 50, 100, 200 or 500ms.</p>

<div style="border: 1px solid black; padding: 2px; display: inline-block;">SET</div> ↓		<div style="border: 1px solid black; padding: 2px; display: inline-block;">▶</div> → UNITS PARAMS INPUTS OUTPUTS ALARMS COMMS TM/LOG SETUP TEST END
PULSE	OUT _n	<p><i>The Output Pulse Factor is available for viewing and editing only when the assigned variable is a total (pulse output) type.</i></p> <p>The Output Pulse Factor is the scaling factor for the retransmission of the measured total quantity.</p> <p>For example, if “volume” is chosen as an output variable and engineering unit is cubic metres, then a pulse factor of 1.000 generates one pulse for 1 m³. Similarly, a pulse factor of 3.000 generates one pulse for 3 m³.</p> <p>For more information, see Output Pulse Factor on page 41.</p> <p>The output pulse factor cannot be 0 (zero).</p>
PT-MIN PT-MAX	OUT _n OUT _n	<p><i>The Output Minimum Point and Maximum Point are available for viewing and editing only when the assigned variable is a rate (4-20mA output) type.</i></p> <p>The output minimum value corresponds to the 4mA point and the output maximum value corresponds to the 20mA point.</p> <p>Setting the output range differently from the input range enables the instrument to amplify the input signal. You can drive a chart recorder that “zooms in” on a specified range of values instead of displaying the full operating range of the transducer.</p> <p>For example, if “volume flow” is chosen as an output variable and engineering unit is cubic metres per minute, then setting the minimum point to 30 and the maximum point to 100 would reflect the volumetric flow rate range of 30 to 100m³/min. At rates above the maximum and below the minimum points, the output remains at 20mA and 4mA respectively.</p>

Output Pulse Factor

Increasing the output pulse width reduces the maximum frequency at which a total variable can be retransmitted. Pulses will be missed if the output cannot “keep up” with the rate of total counts. You can use the output pulse factor to ensure that this maximum is not reached.

The maximum pulse output frequency is determined by:

$$\frac{1000}{(2 \times \text{pulse width in ms})} \text{ Hz}$$

The minimum pulse factor required is determined by:

$$\frac{\text{max rate of total}}{\text{max pulse output frequency}}$$

For example: To calculate the required pulse factor to avoid losing counts in retransmission if a total counts at a maximum rate of 75 units/sec (Hz) and the required pulse width of a remote counter is at least 50ms:

The maximum pulse output frequency is: $\frac{1000}{2 \times 50} = 10\text{Hz}$

The minimum pulse factor for that frequency is: $\frac{75}{10} = 7.5\text{Hz}$

Alarms

The alarm relay(s) can be assigned to rate variables such as volume flowrate, or set as an equipment failure alarm.

The alarm switches “on” whenever an alarm condition exists. The alarm switches “off” when the alarm condition no longer exists. However, you may need to configure external alarm devices that require acknowledgement for cancelling an alarm.

Equipment Failure Alarm

Any alarm relay can be assigned as an equipment failure alarm. This alarm setting can have normally closed (open) contacts that open (close) when the instrument displays any error message as listed in **Error Messages** on page 51.

<input type="button" value="SET"/> ↓	<input type="button" value="▶"/> → UNITS PARAMS INPUTS OUTPUTS ALARMS COMMS TM/LOG SETUP TEST END
RELAY ALRMn	<p>Select a rate variable to assign to the alarm relay.</p> <p>Note: If the alarm type is set to “equipment alarm”, this relay assignment setting is ignored.</p> <p>Press <input type="button" value="▲"/> or <input type="button" value="▼"/> to select the variable that is required as an alarm.</p>







SET ↓		▶ → UNITS PARAMS INPUTS OUTPUTS ALARMS COMMS TM/LOG SETUP TEST END
TYPE	ALRM _n	<p>The options available for alarm types are as follows:</p> <ul style="list-style-type: none"> • HI-NO — High Alarm, Normally Open contacts • HI-NC — High Alarm, Normally Closed contacts • LO-NO — Low Alarm, Normally Open contacts • LO-NC — Low Alarm, Normally Closed contacts • BD-NO — Band Alarm, Normally Open contacts • BD-NC — Band Alarm, Normally Closed contacts • AL-NO — Equipment Alarm, Normally Open contacts • AL-NC — Equipment Alarm, Normally Closed contacts <p>Press ▲ or ▼ to select the type of alarm required.</p>
POINT	ALRM _n	<p><i>The Alarm Setpoint is available for viewing and editing for any alarm type except 'equipment alarms'.</i></p> <p>The Alarm Setpoint is the value (in engineering units of assigned variable) at which the alarm condition occurs and therefore the alarm is on.</p> <p>Each alarm is completely independent, e.g. a High alarm does NOT need to have a higher setpoint than the a Low alarm.</p>
HYST	ALRM _n	<p><i>The Alarm Hysteresis is available for viewing and editing for any alarm type except 'equipment alarms'.</i></p> <p>Alarm hysteresis loops occur when the alarm toggles continuously on and off when the process variable is close to the setpoint.</p> <p>For a high alarm, the alarm activates when the value of the variable rises above the alarm setpoint and deactivates when the value falls below the alarm setpoint minus the amount of the hysteresis setting (if any).</p> <p>For a low alarm, the alarm activates when the value of the variable falls below the alarm setpoint and deactivates when the value rises above the alarm setpoint plus the amount of the hysteresis setting (if any).</p> <p>For a band alarm, the alarm activates whenever the value of the variable is outside the setpoint plus or minus the amount of the hysteresis.</p> <p>For example, with a high alarm setpoint of 200, and a hysteresis setting of zero, a value oscillating between 197 and 202 will cause the alarm to toggle on at 200 and toggle off below 200. However, if the hysteresis is set to 5, the value of the variable must fall below 195 to cancel the alarm. The alarm will reactivate only when the value again rises above 200.</p>

Communications

The instrument has the following communication ports:

- **RS-232 Port** - A 9-pin female connector on the rear panel of the instrument.
- **RS-485 Port** (optional) - Terminals on the rear panel.
- **Infra-red Port** - Discontinued - Although program settings may be visible in calibration, the required hardware is no longer available. The Infra-red protocol assignment (`PROTOC INFR`) should be set to NONE and the remaining `INFR` settings can be ignored.

<input type="button" value="SET"/> ↓		<input type="button" value="▶"/> → UNITS PARAMS INPUTS OUTPUTS ALARMS COMMS <small>TM/LOG SETUP TEST END</small>
PROTOC RS232 RS485 INFR	<p>The Communications Protocols can be assigned to the communication ports as follows (a protocol cannot be assigned to more than one port at a time):</p> <ul style="list-style-type: none"> • ASCII - Simple ASCII available for all ports • RTU - Modbus RTU available for all ports • PRN - Printer Protocol available for RS232 and RS485 • NONE - If a port is not being used, set the protocol to NONE. <p>Printer Protocol (PRN) is only available if the option with Real Time Clock is installed.</p> <p>For the selected port, press <input type="button" value="▲"/> or <input type="button" value="▼"/> to select the desired protocol.</p>	
BAUD RS232 RS485 INFR	<p>The Baud setting is the speed of the communication port in data bits per second.</p> <p>The baud rate of the instrument must match the baud rate of the communication device that the instrument is connected to.</p> <p>Use <input type="button" value="▲"/> or <input type="button" value="▼"/> to select 2400, 4800, 9600 or 19200 baud.</p>	
PARITY RS232 RS485 INFR	<p>The Parity bit helps to detect data corruption that might occur during transmission.</p> <p>The parity bit setting of the instrument must match the parity bit setting of the communication device that the instrument is connected to.</p> <p>Press <input type="button" value="▲"/> or <input type="button" value="▼"/> to select EVEN, ODD, or NONE.</p>	
S-BITS RS232 RS485 INFR	<p>The Stop bit indicates the end of a transmission. Stop bits can be 1 or 2 bit periods in length. The stop bit setting of the instrument must match the stop bit setting of the communication device that the instrument is connected to.</p> <p>Press <input type="button" value="▲"/> or <input type="button" value="▼"/> to select 1 or 2 stop bits.</p>	

 ↓		 → UNITS PARAMS INPUTS OUTPUTS ALARMS COMMS <small>TM/LOG SETUP TEST END</small>
RTU	DATA	<p>The Modbus RTU data format for the 2-register (4-byte) values can be set as either floating point or long integer values.</p> <p>Use  or  to select FLOAT or INTEGER.</p>
RTU	ADDR	<p>The Modbus RTU protocol address must be in the range of 1 to 247. When multiple instruments (slaves) are connected to one communication device (master), each assigned address must be unique.</p> <p>Note: The master device uses the RTU address 0 (zero) for broadcasting to all connected slave units.</p>
ASCII	ADDR	<p>The ASCII protocol address identifies each communicating device.</p> <p>The address must be in the range of 1 to 255. When multiple instruments (slaves) are connected to one computer (master), each assigned address must be unique.</p>
FLASH	PORT	<p>The Flash Driver Port assignment defines the communication port for downloading software into the instrument.</p> <p>The default setting of this assignment is the RS-232 port.</p> <p>Press  or  to select RS-232, RS-485, or INFRA.</p>

Time Settings and Data Logging

Instrument Clock

Note: The real-time clock is part of the advanced option package.

The instrument has a real-time clock for recording logged events. The clock displays the time and the date. The date format can be set to European format (day/month/year) or American format (month/day/year). The time clock uses the 24-hour format.

The clock will continue to operate for up to 5 years (typically) on the internal battery if there is no power connected to the instrument. Therefore, after an interruption to the power supply, the instrument recommences normal operation although there will be no data recorded during the period without a power supply.

Note: If there is an interruption to the power supply and the battery has failed, the instrument displays an error message when the power supply is restored. In this case, you should set the current time and date so that the instrument continues to log data at the correct times.

Data Logging

The instrument will log the main-menu variables if real-time clock option is installed. The logs are at fixed intervals of hours, days, weeks, months and years. The instrument can store a total of 1530 log entries which are distributed over the log intervals as follows:

- 800 hourly logs
- 400 daily logs
- 200 weekly logs
- 100 monthly logs
- 30 yearly logs

If the number of log entries exceeds the programmed number for a particular time interval, the oldest log entry is overwritten by the newest one for that time interval.

Also note that the totals are saved as accumulated totals.

The log parameters (below) also determine the number of records to be included in a report printout if the printing option is used.

SET ↓		▶ → UNITS PARAMS INPUTS OUTPUTS ALARMS COMMS TM/LOG SETUP TEST END
DATE	FORM	<p>Clock Date Format</p> <p>The European date format is: dd/mm/yyyy or (Day-Month).</p> <p>The American date format is: mm/dd/yyyy or (Month-Day).</p> <p>Press ▲ or ▼ to select DAY-M or M-DAY</p>
CLOCK	YEAR	The Clock Year defines the current year for the real-time clock.
CLOCK	M-DAY	The Clock M-DAY setting defines the current month and date for the real-time clock. This parameter is programmed in Month-Day format for both European and American date formats.
CLOCK	H-MIN	The Clock H-MIN setting is the current time in hours and minutes for the real-time clock.
HOUR	LOGS	<p>Set the number of Hourly Logs to appear on the printed log report.</p> <p>The hourly log entry occurs at 00 minutes each hour.</p>
DAY	LOGS	<p>Set the number of Daily Logs to appear on the printed log report.</p> <p>The daily log entry occurs at 00 hours and 00 minutes each day.</p>

<input type="button" value="SET"/> ↓		<input type="button" value="▶"/> → UNITS PARAMS INPUTS OUTPUTS ALARMS COMMS TM/LOG SETUP TEST END
WEEK	LOGS	<p>Set the number of Weekly Logs to appear on the printed log report.</p> <p>The weekly log entry occurs at 00 hours and 00 minutes each Monday.</p>
MONTH	LOGS	<p>Set the number of Monthly Logs to appear on the printed log report.</p> <p>The monthly log entry occurs at 00 hours and 00 minutes on the first day of the month.</p>
YEAR	LOGS	<p>Set the number of Yearly Logs to appear on the printed log report.</p> <p>The yearly log entry occurs at 00 hours and 00 minutes on the first day of the year.</p>
RESET	LOGS	<p>Reset the logged data. You may need to reset (clear) the logged data if you change the time/log settings.</p> <p>Press <input type="button" value="▲"/> or <input type="button" value="▼"/> to select YES, then press the <input type="button" value="SET"/> key. The instrument makes three beeps to confirm the reset command.</p>
REPORT	TYPE	<p>The Printer Protocol Report Type determines the nature of the printout from the REPORT PRINT - HOLD.SET prompt in the main menu. The following report types available in this instrument are:</p> <ul style="list-style-type: none"> • REP-01 Hourly Logs Report • REP-02 Daily Logs Report • REP-03 Weekly Logs Report • REP-04 Monthly Logs Report • REP-05 Yearly Logs Report • REP-06 Previous Day's 24 Hour Report (0Hr – 23Hr, minimum 48 hourly logs required) <p>Press <input type="button" value="▲"/> or <input type="button" value="▼"/> to select Report Type.</p>
PRN	TYPE	<p>The Printer Protocol Printer Type allows the nature of the printer being used to be specified. The following printer types available in this instrument are:</p> <ul style="list-style-type: none"> • PRN-01 Generic computer printer • PRN-02 Generic roll printer (prints first line first) • PRN-03 Slip printer TM295 • PRN-04 Label (roll) printer - Citizen CMP30L <p>Press <input type="button" value="▲"/> or <input type="button" value="▼"/> to select Printer Type.</p>
PRINT	ACCUM	<p>Select whether the accumulated totals are printed in addition to the non-accumulated totals for printer protocol.</p>

General Setup Parameters

SET ↓	▶ → UNITS PARAMS INPUTS OUTPUTS ALARMS COMMS TM/LOG SETUP TEST END
DEFAULT TOTAL	<p>The instrument displays the default Total when the user presses the TOTAL key.</p> <p>If the display timeout is enabled, the instrument displays the default Total when there is no user action for the period of the display timeout period.</p> <p>Press <input type="button" value="▲"/> or <input type="button" value="▼"/> to select the default total display.</p>
SUPPLY VOLT	<p>The instrument provides a power-limited supply for external transducers.</p> <p>Press <input type="button" value="▲"/> or <input type="button" value="▼"/> to set the transducer supply voltage between 8 and 24 volts DC as required.</p>
T-OUT MODE	<p>If the Display Timeout mode is enabled, and there is no user activity for the defined timeout period, the display panel returns to the default display.</p> <p>This function is useful for the following reasons:</p> <ul style="list-style-type: none"> • to return the display to a preferred variable after the user has finished reading other information, • to cancel the calibration mode and return to the default display if the user does not exit from the calibration mode for any reason. <p>Press <input type="button" value="▲"/> or <input type="button" value="▼"/> to select the display timeout function as follows:</p> <ul style="list-style-type: none"> • DISABLE - Timeout is completely disabled. • EN DISP - Timeout is enabled during Normal mode and Calibration View mode. • EN EDIT - Timeout is enabled during Calibration Set mode. • EN ALL - Timeout is enabled for all modes.
T-OUT SEC	<p>The Display Timeout period defines the delay for the Display Timeout mode if it is enabled.</p> <p>The display timeout period can be from 10 to 99 seconds.</p>
RESET MODE	<p>The Totals Reset mode can be configured to reset the non-accumulated totals to zero.</p> <p>Press <input type="button" value="▲"/> or <input type="button" value="▼"/> to select the reset mode as follows:</p> <ul style="list-style-type: none"> • NONE - The user cannot reset the non-accumulated totals. • INSTANT - When the user presses the RESET key, the instrument resets all non-accumulated totals. • DELAYED - When the user presses the RESET key and holds it for two seconds, the instrument resets all non-accumulated totals.

SET ↓	▶ → UNITS PARAMS INPUTS OUTPUTS ALARMS COMMS TM/LOG SETUP TEST END
RESET ACCUM	<p>The Reset Accumulated Totals function clears all of the accumulated totals and the non-accumulated totals.</p> <p>Press ▲ or ▼ to select YES, then press the SET key. The instrument makes three beeps to confirm the reset command.</p>
DISPL TAGS	<p>The Display Tags option determines whether the instrument displays the default display tags or the user-defined tags. The display tag setting also defines whether the instrument displays the default error and warning messages, or the user-defined messages.</p> <p>Note: The user-defined tags can be entered into the instrument only by the manufacturer or the distributor.</p> <p>Press ▲ or ▼ to select the Display Tags option as follows:</p> <ul style="list-style-type: none"> • DEFAULT - the instrument displays the default (English) tags • USER - the instrument displays the user-defined tags.
BACK-L T-OUT	<p>If the backlight timeout is enabled, and there is no user activity (any keys pressed) for a period of 10 seconds, the display backlight switches off to save power. The backlight switches on when a key is pressed. Select the backlight timeout mode as required.</p> <p>Press ▲ or ▼ to select ENABLE or DISABLE.</p>
RATES DP	<p>This parameter sets the maximum number of decimal places for displaying or printing main menu rates.</p>
TOTALS DP	<p>This parameter sets the maximum number of decimal places for displaying or printing main menu totals.</p>

Test Menu

The Test menu enables you to view the inputs and outputs to and from the instrument.

In Calibration Set mode, (by entering the system password) you can control the outputs and the alarms as described in the table below.

SET ↓	▶ → UNITS PARAMS INPUTS OUTPUTS ALARMS COMMS TM/LOG SETUP TEST END
FINP1 Hz	<p>The frequency of the input to FINP1 is displayed in Hertz.</p>
AINP n <i>units</i>	<p>The units are displayed according to the calibration setup for the analog input. If unused or set to Default the input is 4-20mA and displayed in mA.</p>

SET ↓	▶ → UNITS PARAMS INPUTS OUTPUTS ALARMS COMMS TM/LOG SETUP TEST END
L INP _n STATE	<p>You can view the state of the logic inputs. If the input is an open contact or inactive it will display HI. If the input is a closed contact or active it will display LO.</p>
OUT _n STATE	<p>You can control the state of the outputs. Press the ▲ or ▼ keys to set the output state as follows:</p> <ul style="list-style-type: none"> • PROCESS - the output depends on the current values of the inputs and the calculations that the instrument performs. <p>For a pulse output, such as a total, the output produces a pulse train as follows:</p> <ul style="list-style-type: none"> • ON - a pulse train with a pulse width as set in the Outputs menu. • OFF - no output. <p>For a 4-20mA output, such as a rate, the output is as follows:</p> <ul style="list-style-type: none"> • HI - the output is set to 20mA. • LO - the output is set to 4mA.
ALRM _n STATE or REL -n	<p>You can control the state of the relays (alarms). Press the ▲ or ▼ keys to set the selected relay as follows:</p> <ul style="list-style-type: none"> • PROCESS - the relay operates according to the current values of the inputs and the relay settings as programmed. • OPEN - the relay output contacts are set to “open”. • CLOSED - the relay output contacts are set to “closed”.
SUPPLY ✓	<p>You can display the actual DC output supply voltage, which may help with troubleshooting.</p> <p>If the actual supply voltage is lower than the preset value (refer to General Setup Parameters on page 48) it may indicate that the output is overloaded.</p>

System Messages

The instrument displays messages for defined events and fault conditions.

The manufacturer or distributor can enter user-defined text for the messages. This user-defined text is displayed, instead of the default (English) messages, when the Display Tags option in the Setup menu is set to USER.

Error Messages

Failure of Analog Input Sensor

If there is a failure of an analog input sensor for a process parameter such as temperature or pressure, the instrument sets the value of that parameter to 0 and displays the relevant error message. The input sensor and connections need to be inspected and may require replacement.

The instrument also sets the results of calculations that depend on the failed input(s) to 0. For example, if the temperature sensor fails, the instrument displays a temperature reading of 0 and the calculated energy flow as 0. However, if the flow sensors are still functioning, the instrument continues to calculate and display volume flow.

Default Value on Exception

If Default Value On Exception has been enabled in the INPUTS section of calibration, the default value will automatically be used so that all calculations can continue. The error message will still continue to scroll across the display until the fault is corrected at which point the calculations will revert to using the live input.

Override Error Condition

While a fault is being rectified on an analog input for a process parameter, an operator with calibration access can set the Analog Input Signal Type to DEFAULT and the Analog Input Default Point to a typical process value. If there are no other faults, the instrument continues to operate by using the default value.

The system displays error messages as described in the following table:

Error Messages	Description
CPU Card Failure	There are failed components on the CPU card and technical support is required.
Power Supply is Low	The input and/or output power supply voltage is too low, ensure that: (a) input power supply voltage is within the specified range (b) output power supply is not overloaded.

Error Messages	Description
New/Failed Battery - Set Time	The real-time clock has lost the correct time because the battery has failed, or there is a new battery. Set the current time and date (in the TM/LOG menu) to clear the error message and to continue data logging at the correct times. Note: The instrument can continue operating with a failed battery, but the correct time will be lost if there are interruptions to the power supply.
Temperature Sensor 1 Failure	The temperature sensor on analog input 1 has failed. To deactivate the error, the Analog Input Signal Type can be set to DEFAULT to use a programmed default value instead of the sensor signal.
Temperature Sensor 2 Failure	The temperature sensor on analog input 2 has failed. To deactivate the error, the Analog Input Signal Type can be set to DEFAULT to use a programmed default value instead of the sensor signal.
Temperature is Out of Range	The feed and/or return temperature inputs are outside of the allowed calculation range.

Warning Messages

The system displays warning messages as described in the following table:

Warning Messages	Description
Value Has Been Set to Default	You have entered an invalid value for a parameter. Therefore, the instrument has set the default value.
Over Total Limit - Maximum Set	You have exceeded the maximum number of logging entries for the combined time bases. The instrument has set the current log setting to the remaining maximum number.
Already Assigned to Other Port	You have tried to assign a particular protocol type to more than one serial communication port. The instrument has set the protocol to NONE.

Chapter 6

Communications

Overview

This chapter describes the communications between the instrument and another communicating device such as a computer or a printer. You should have relevant information about the devices to which the instrument will be connected. Some connection examples are included in this manual, however, the operation and connection of other devices is outside the scope of this manual.

Hardware Interconnection

The instrument has the following communication ports:

- RS-232 port on the rear panel (DB9 female connector)
- RS-485 port on the rear panel (optional)

The appropriate interface and protocols are selected during calibration.

RS-232 Port

The RS-232 port provides communication between the instrument and one other device such as a host computer or a printer.

Note: A printer must have a serial port to be able to be directly connected to the flow computer. It is not possible to communicate directly with a printer via a parallel port.

Computers use either a DB9 or a DB25 connector, and the connections to each type are shown in Figure 16.

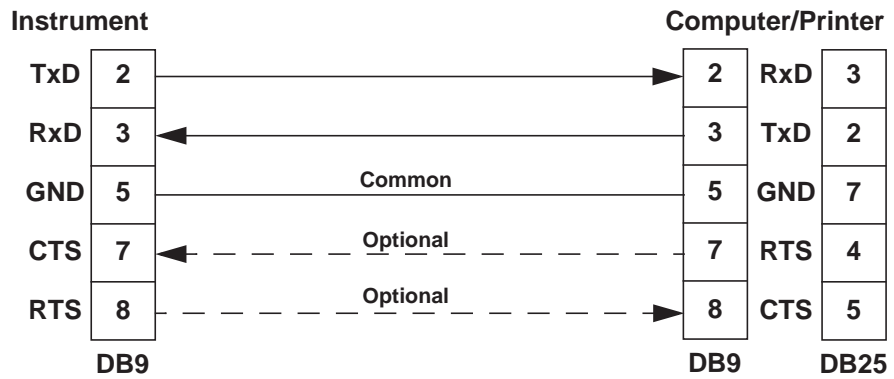

Figure 16 RS-232 Cable Connections to a Computer

Note: The instrument requires a cable with straight-through connections. Do not use a null modem cable for RS-232 connection to a computer.

RS-485 Port

The RS-485 port enables communication with multiple devices. Each device has a unique address so that the “master” device can communicate with specific “slave” devices.

On RS-485 links, an external terminating resistor must be connected at the furthest end of the cable. When multiple instruments are connected, they should be “daisy chained” in a multidrop configuration as shown in Figure 17. Up to 32 units can be connected to the interface at a maximum distance of 1200 metres.

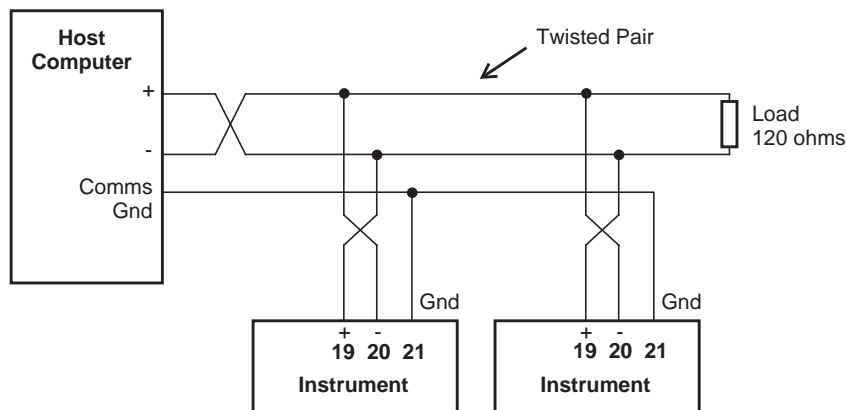

Figure 17 RS-485 Connections

Protocols

The communications protocols can be assigned to the communication ports on the instrument as follows:

- **ASCII** - Simple ASCII available for all ports
- **RTU** - Modbus RTU available for all ports
- **PRN** - Printer Protocol available for RS232 and RS485
- **NONE** - If a port is not being used, set the protocol to NONE.

Note: The Printer Protocol is only available if the option with Real Time Clock is installed. Also a protocol cannot be assigned to more than one port at a time as described in **Communications** on page 44.

- **ASCII** - In this ASCII protocol each command and response is a string of ASCII characters. This proprietary protocol is developed by Contrec to allow for simple information interchange. The main advantages of this mode are that it allows extended time intervals to occur between characters without causing a timeout error and that messages can be sent and monitored easily with a simple ASCII terminal.
- **Modbus RTU** - Modbus RTU is an industry-standard protocol which allows the instrument to be easily connected to computers running supervisory software systems. The main advantage of this mode is that its greater character density allows better data throughput than ASCII mode, however each message must be transmitted in a continuous stream.
- **Printer** - In the Printer protocol there is a selection of printer types. Please refer to the **Printer Protocol** on page 66 for full details.

Simple ASCII Protocol

This simple ASCII protocol requires that all requests are initiated with a colon (:) and terminated with a carriage return (C_R). The message termination can include a linefeed before the carriage-return ($L_F C_R$), but it is the carriage-return that acts as the message termination.

All responses by the instrument are terminated with a linefeed and a carriage-return ($L_F C_R$).

Requests Format

The format of a request to the instrument is as follows:

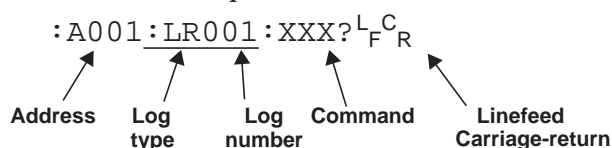

Each request must include the address and command portions. The underlined section is an optional part of the request string.

Address

In multipoint communications, each instrument must have a unique address and it is essential in the request for identifying a particular instrument. However, it may be set to 000, for special broadcast commands.

For single-instrument communications, the address can also be set to 000 in the request.

Refer to **Communications** on page 44 for setting the instrument address.

Note: The instrument always responds with its address in the header regardless of the type of request.

Log Type and Number

The log type and number enables a communicating device to retrieve data from the instrument. The data can be from timebased and/or event-based logs. Data can also be from the current process variables with the either accumulated or non-accumulated (resettable) totals.

All logged records of the process variables contain the accumulated totals.

The log request is optional. If the log request is not included, or the log number is set to 000, the instrument returns the current process variables. If the log request is included, the log number defines the specific log entry by counting backwards. The most recent log entry for a timebase is 001.

The “last edit” log records the process variables at the time of the last exit from the calibration edit mode. There is only one “last edit” log, therefore, if a number is included in the request, the instrument ignores the number and returns the data at the time of the last edit. Likewise, there is only one set of current process variables with “non-accumulated totals”, therefore it also ignores any log number included in the request.

The types of logs applicable to this instrument are as follows:

Log Type
LH - hourly log
LD - daily log
LW - weekly log
LM - monthly log
LY - yearly log
LE - last edit log
LN - current totals displayed as Non-accumulated

The number of the log entry is the same as shown on the front panel of the instrument. For example, a request for LH003 would return the data for the log entry two hours prior to the most recent hourly log entry. If the current time is between 9:00am and 10:00am, the most recent hourly log LH001 was recorded at 9:00. Therefore, LH002 is for 8:00 and LH003 is for 7:00. After 10:00am in this example, LH003 becomes the 8:00 log.

Instrument Responses

The instrument response time to any enquiry is not more than 300ms. The responses from the instrument are in the following format:

```

HEADERLFCR
DATALFCR
DATALFCR
.
.
.
DATALFCR
LFCR
    
```

The components of the response message are as follows:

Header

The format of the response header from the instrument is as follows:

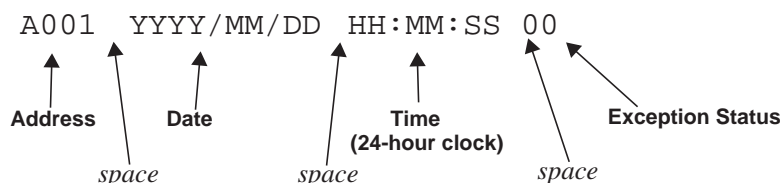

The instrument **Exception Status** codes that the instrument returns for the ASCII protocol are the same as those described for the Modbus RTU protocol in **Instrument Exception Status** on page 64.

Data

The format of the data variables from the instrument is as follows:

8	9	1	2	3	.	4	5	6		M	W	h							E	N	E	R	G	Y	
1	2	3	4	5	6	7	8	9	10	11	12	13	14	15	16	17	18	19	20	22	23	24	25	26	27
Value (aligned right)											space	Unit (aligned left)						space	Item (aligned left)						

Note: The decimal point in the Value is always at character position 8. Therefore whole numbers are aligned right at the decimal point, with trailing zeroes.

Variables Request

The variables request asks the instrument to return the value of one or more requested variables. All totals are transmitted as accumulated totals.

Command	Description
:RVA?	Return all variables
:RVD?	Return the default Total and Rate
:RV0? ... :RV9?	Return the specific variable. The numbers relate to the position in the variables menu. For example, V0 is Energy, V1 is Power and so on.

Variables Request and Response Example

The following request is for the only instrument that is connected to the communication port to return the values of all main menu variables.

```
: A 0 0 1 : R V A ? LF CR
```

The following is an example of a hypothetical instrument response. Refer to on page 4 for the list of variables that would be returned for this application.

```
A 0 0 1 2 0 0 2 / 0 3 / 1 4 1 8 : 2 5 : 0 0 0 0 LF CR
      6 . 1 1 6 M W h E N E R G Y LF CR
      1 6 . 5 7 3 M W P O W E R LF CR
    1 3 2 0 . 5 3 0 m 3 V O L U M E LF CR
      5 8 . 3 0 0 m 3 / M V - F L O W LF CR
    7 6 2 7 . 1 1 7 K G M A S S LF CR
      3 4 4 . 4 6 0 K G / M M - F L O W LF CR
      2 3 0 . 0 0 0 D E G C T E M P LF CR
      1 . 2 6 0 M P A P R E S S LF CR
      0 . 1 7 4 m 3 / K G S P - V O L LF CR
    2 8 8 6 . 7 6 0 K J / K G S P - E N T LF CR

LF CR
```

The following message to an instrument, requests the current values for the default rate and total:

```
: A 0 0 1 : R V D ? LF CR
```

The instrument response would be similar to the following:

```
A 0 0 1 2 0 0 2 / 0 3 / 1 4 1 8 : 2 5 : 0 0 0 0 LF CR
      1 2 6 . 4 5 5 m 3 V O L U M E LF CR
      2 0 . 4 3 7 m 3 / M V - F L O W LF CR

LF CR
```

Log Request

The log request asks the instrument how many logs it stores in the particular timebase. These are the values described in **Time Settings and Data Logging** on page 45.

Command	Description
:RLH?	Return the number of hourly logs
:RLD?	Return the number of daily logs
:RLW?	Return the number of weekly logs
:RLM?	Return the number of monthly logs
:RLY?	Return the number of yearly logs
:RLR?	Return the number of log records (non- timebased logging)

Log Response Example

The following message asks the instrument with address 001 to return the number of logs that the instrument stores:

```
: A 0 0 1 : R L R ? LF CR
```

The instrument response would be similar to the following:

```
A 0 0 1 2 0 0 2 / 0 3 / 1 4 1 8 : 2 5 : 0 0 0 0 LF CR
2 4 LF CR
LF CR
```

Clear Data Request

The clear data request asks the instrument to clear the data in the selected registers.

Command	Description
:RCN?	Clear the non-accumulated (resettable) totals
:RCA?	Clear the accumulated totals
:RCL?	Clear the logs except for the “last edited” log

Clear Data Request Example

The following message asks the instrument with address 001 to clear the logged data that the instrument stores:

```
: A 0 0 1 : R C L ? LF CR
```

The instrument response would be similar to the following:

```
A 0 0 1 2 0 0 2 / 0 3 / 1 4 1 8 : 2 5 : 0 0 0 0 LF CR
LF CR
```

Instrument Information Request

The Instrument Information request asks the instrument to return the general information about the model and version codes. The instrument exception status is returned as a part of the header as it is with the header for all command responses.

Command	Description
:RIG?	Return the general information about the instrument such as Model number, Application number, Version and Serial numbers etc. These items are returned as a block in the same format as shown on the display in the “Model Info” menu.

Instrument Information Response Example

The following message asks the instrument with address 001 to return the general information about the instrument:

```
: A 0 0 1 : R I G ? LF CR
```

The following is an example of a hypothetical instrument response:

```
A 0 0 1 2 0 0 2 / 0 3 / 1 4 1 8 : 2 5 : 0 0 0 0 LF CR
5 1 5 M O D E L - 1 1 - F - LF CR
S C 0 1 I N P U T F - T P - - LF CR
S C 0 1 V E R S 0 1 0 1 . 0 0 1 LF CR
C U S T O M V E R S 0 0 0 0 0 1 LF CR
U N I T S / N 1 2 3 4 5 6 LF CR
LF CR
```

1	2	3	4	5	6	7	8	9	10	11	12	13	14	15	16	17	18	19	20	21	22	23	24	25	26	27	28	29
---	---	---	---	---	---	---	---	---	----	----	----	----	----	----	----	----	----	----	----	----	----	----	----	----	----	----	----	----

Corrupted or Invalid Requests

If the instrument receives a corrupted or incomplete request, there is no response. The instrument discards any partial request and waits for the next enquiry.

If the instrument receives a request message in the correct format, but for a non-existent option, it returns only the message header. For example, if the instrument received the following request variables message :A001:RVT? it will return only the header because there is no T option for the ‘Variables Request’ message.

Modbus RTU Protocol

Modbus RTU (remote terminal unit) is an industry standard protocol that allows the instrument to be easily interfaced to other communication devices.

The instrument implements the Modbus protocol as detailed in the *Modicon Modbus Protocol Reference Guide* PI-MBUS-300 Rev J (June 1996).

Message Format

In RTU mode, messages start with a silent interval of at least 3.5 character times. The first field transmitted is the device address. Following the last transmitted character, a similar interval of at least 3.5 character times marks the end of the message. A new message can begin after this interval. The entire message frame must be transmitted as a continuous stream. A typical message frame is shown below:

Address	Function	Data	CRC Check
1 byte	1 byte	n bytes	2 bytes

Except for broadcast messages, when a master device sends a query to a slave device, it expects a normal response. One of four possible events can occur from the master's query:

- If the slave device receives the query without a communication error, and can handle the query normally, it returns a normal response.
- If the slave does not receive the query due to a communication error, no response is returned. The master program has to process a timeout condition for the query.
- If the slave receives the query, but detects a communications error (parity or CRC), no response is returned. The master program has to process a timeout condition for the query.
- If the slave receives the query without a communication error, but cannot handle it (for example, if the request is to read a nonexistent register), the slave will return an exception response informing the master of the nature of the error.

Instrument Address

The address of the instrument is programmable in the range from 1 to 247. Some addresses are reserved according to PI-MBUS-300 and have a special meaning:

- 0 = Broadcast, no response required from slave devices
- 248 to 255 Reserved

Function Codes

The instrument accepts the following function codes:

Code	Name	Description
03	Read data register(s)	Obtain the content of one or more 2-byte data registers.
06	Preset data register	Preset one 2-byte data register.
07	Read status register	Obtain the content of 1-byte status register.
16	Preset data register(s)	Preset one or more 2-byte data registers.

Exception Response

The instrument forms an exception response by adding 80H to the function code and using an exception code as the 1-byte data field in the returned frame. Implemented exception codes are as follows:

Code	Name	Description
01	Illegal function	The function code is not a legal action for the slave.
02	Illegal data address	The data address is not a legal address for the slave.
03	Illegal data value	The data value is not a legal value for the slave.
05	Acknowledge	The slave has accepted the request and is processing it, but a long duration of time will be required to do so.
06	Slave device busy	The slave is engaged in processing a long duration program command. The master should re-transmit the message later when the slave is free.

List of Data Registers

The following list describes the addresses and meaning of the data registers in the instrument. The data values are expressed in the engineering units that were selected for the variables when the instrument settings were configured. The “Data Type” for the 2-register (4-byte) data values can be set in programming mode as Floating Point or Long Integer as described in **Communications** on page 44.

The registers are grouped in blocks that relate to a particular function of the instrument.

Note: Conventional numbering of registers often starts from 1, therefore be aware that “register 1” in this case has “address 0” and so on.

Current and Logged Process Data

This block of registers is available for the retrieval of current or logged process data with its matching time and date information.

Use the log type and log number to retrieve the logged information from the appropriate register. If a particular log number does not exist, or the instrument does not have the optional real-time clock, the time and date stamp and associated variables are set to zero.

Register	Name	Comments	Read Only or Read/Write	Type
1	Energy	<p style="text-align: center;">Process Variables</p> <p>By default totals are the Accumulated values. If current Non-accumulated (resettable) totals are required, set register 37 to 06. All logged totals are the Accumulated values.</p>	R	DT*
3	Power		R	DT
5	Volume		R	DT
7	Volume Flowrate		R	DT
9	Mass		R	DT
11	Mass Flowrate		R	DT
13	Feed Temperature		R	DT
15	Return Temperature		R	DT
17	Differential Temperature		R	DT
19	Reserved		R	DT
21	Reserved		R	DT
23	Reserved		R	DT
25	Reserved		R	DT
27	Reserved		R	DT
29	Reserved		R	DT
31	Year	<p style="text-align: center;">Current Date/Time or Logged Date/Time Stamp (see register 38 Log Number). Only current Date/Time can be edited</p>	R/W	I†
32	Month		R/W	I
33	Date		R/W	I
34	Hour		R/W	I
35	Minute		R/W	I
36	Second		R	I
37	Log Type	00 - hourly or log records 01 - daily 02 - weekly 03 - monthly 04 - yearly 05 - last edit of calibration 06 - current totals are non-accumulated values, register 38 is ignored.	R/W	I
38	Log Number	If set to 0, current variables and Date/Time are retrieved	R/W	I
39	Clear Data	01 - clear logs 02 - clear accumulated totals 03 - clear non-accumulated totals	W	I
40	Reserved			

* DT = Data Type of 2-register (4 byte) values can be set as Floating Point or Long Integer values

† I = Integer (2 bytes) (Holding Registers)

Note: The Floating Point variable is represented in IEEE-754 Floating Point 4-byte format and requires two 2-byte data registers:

IEEE-754	Modicon Registers
1st byte	low byte (register X)
2nd byte	high byte (register X)
3rd byte	low byte (register X+1)
4th byte	high byte (register X+1)

This means that two data registers must be read or written to obtain, or preset, one data value.

Instrument Exception Status

This register is available to verify the status of the instrument.

Register	Name	Comments	Read Only or Read/Write	Type
41	Exception Status	00 = no error 01 = analog input 1 failure 02 = analog input 2 failure 03 = analog input 3 failure 04 = analog input 4 failure 05 = invalid calibration parameter 06 = invalid reference parameter 07 = invalid property 08 to 09 reserved 10 = process parameters out of range 11 = input is over limit 12 = flow error detected 20 = system failure 21 = power supply is low 22 = new or failed clock battery 23 to 29 reserved 30 = alarm 1 active 31 = alarm 2 active 32 = alarm 3 active 33 = alarm 4 active	R	I*

* I = Integer (2 bytes) (Holding Registers)

Instrument Control and I/O

This block of registers is available in some applications to give access to monitor and/or control some of the instrument.

Register	Name	Comments	Read Only or Read/Write	Type
42	Reserved			
43	Logic Inputs	0 to 15 Binary representation of logic inputs B0 = 0/1 (LSB) input 1 activated/deactivated B1 = 0/1 input 2 activated/deactivated B2 = 0/1 input 3 activated/deactivated B3 = 0/1 input 4 activated/deactivated	R	I
44	Operation Mode	Representation of operation mode 0 = Idle/Local Idle state 1 = HEAT Heating only, positive Dt 2 = COOL Cooling only, negative Dt 3 = BOTH Heating and cooling	R	I
45	Relay State	0 to 15 Binary representation of relay state. 0 = open; 1 = closed. B0 = relay 1 (LSB) B1 = relay 2 B2 = relay 3 B3 = relay 4	R	I*
46	Relay Control	0 to 15 Binary representation of relay control. 0 = open; 1 = close. B0 = relay 1 (LSB) B1 = relay 2 B2 = relay 3 B3 = relay 4	R/W	I
47	Relay Control Source	0 to 15 Binary representation of relay control source. 0 = Local (controlled by instrument operation) 1 = RTU (controlled by Modbus register 46). B0 = relay 1 (LSB) B1 = relay 2 B2 = relay 3 B3 = relay 4	R/W	I
48	Reserved		R	L†
51 to 99	Reserved		R/W	DT
101	Analog Inp.1	Raw analog input data.	R	DT‡
103	Analog Inp.2	4-20mA inputs are read in Amperes.	R	DT
105	Analog Inp.3	0-5V or 1-5V inputs are read in Volts RTD inputs are read in degrees Kelvin.	R	DT
107	Analog Inp.4	Unused inputs are configured as 4-20mA.	R	DT

* I = Integer (2 bytes) (Holding Registers)

† L = Long Integer (2 register = 4 bytes)

‡ DT = Data Type of 2-register (4 byte) values can be set as Floating Point or Long Integer values

Printer Protocol

A printer protocol is available in the 500 Series. It provides the ability to print out live data, individual logged data and to do some report-style printing of logged data. The method of printing these and the format of the printouts is described below.

Note: Printer output is only available if the Real Time Clock option is fitted.

The selection of Printer Protocol can be made for the Communications Protocol options for the RS232 or RS485 port. A list of log report types and printer types available at the end of the TM-LOG calibration menu.

Report Types

The list of report types is as follows:

- REP-01 Hourly Logs Report
- REP-02 Daily Logs Report
- REP-03 Weekly Logs Report
- REP-04 Monthly Logs Report
- REP-05 Yearly Logs Report
- REP-06 Previous Day Hourly Logs (0Hr – 23Hr, minimum 48 hourly logs required)

The number of logs printed in each report is determined by the values programmed in the TM-LOG menu.

Printer Types

The list of available printers is as follows:

- PRN-01 Generic computer printer
- PRN-02 Generic roll printer (printing first line first)
- PRN-03 Slip Printer TM295
- PRN-04 Label (roll) printer - Citizen CMP30L

Customizing a Printout

A customized printout can be provided which can have up to 4 header lines and 3 footer lines. It is also possible to include or exclude each main menu items on the printout. If any customizing of the printout is required discuss this with the distributor.

Types of Printouts

Live Data

The RESET key, when in main menu, is shared as the PRINT key if the printer protocol has been selected. A printout will be initiated whenever this key is pressed. If printing is not required, do not select printer protocol.

The format of this printout will be:

Custom Header Line 1

Custom Header Line 2

Custom Header Line 3

Custom Header Line 4

Current Docket No.

Instrument Serial No. & Tag

Current Date & Time & Status

Total Variable unit value <Resettable total first>

Total Variable unit value (acc) <Accumulated total second>

Variable unit value

Variable unit value

etc.

Custom Footer Line 1

Custom Footer Line 2

Custom Footer Line 3

----- <separation line>

(Note that blank header and footer lines are not printed).

Docket Number

The docket number that appears on the live data printout indicates the print number. This number is cleared when the Accumulated totals are reset. If the Reset Mode is set for Delayed, where a print can be generated without resetting the non-accumulated totals, an additional number in brackets will be shown that indicates the number of prints since the last reset. i.e.

DOCKET No. 000256 (000036)

Instrument Serial Number and Unit Tag

The instrument serial number and unit tag is the same as the information shown in the Model Info menu. For more details refer to [Model Information](#) on page 28.

Individual Log Data

When in the Log Menu and while holding the DISPLAY key to view the data of the log of interest the RESET key can be pressed to initiate a printout of that log entry. The printout will have the time and date stamp corresponding to when the log was taken. After the print has been initiated there will be the opportunity to scroll to view another log entry and print again.

Since in each log entry all totals are stored as the Accumulated value, the printout will not have any resettable totals. The format of the printout with this exception is the same as the LIVE DATA printout:

Custom Header Lines

Instrument Serial No. & Tag

Log Date & Time & Status

Variable unit value <example: total as Accum only>
Variable unit value
etc.

Custom Footer Lines

----- *<separation line>*

Log Report Printing

As there is the likelihood that the reports can be of a considerable length it is strongly recommended that only the 80 Column printer with Z fold (tractor feed) paper be used. This is just as much for the memory storage of printer as it is for the reliable paper supply.

There is a HOLD.SET REPORT PRINT prompt under the main menu with the ability to print the pre-selected type of report. Pressing and holding the SET key for two seconds will initiate the printout. Any of the Log Reports will have the following format:

Custom Header Lines

Title of Report <internally set, indicates report type>

Current Date & Time

Instrument Serial No. & Tag

----- *<separation line>*

Log No. Date & Time & Status

Variable unit value <example: total as Accum only>
Variable unit value
etc.

----- <separation line>
Log No. Date & Time & Status
Variable unit value <example: total as Accum only>
Variable unit value
etc.

----- <separation line>
Log No. Date & Time & Status
Variable unit value <example: total as Accum only>
Variable unit value

ETC

Custom Footer Lines

----- <separation line>

Reports will print in the historical order, and for those logs that have no data (e.g. unit was powered off at the time) the print will show “Data not available”. i.e.

Log No. Date & Time & Status
Variable unit value <example: total as Accum only>
Variable unit value
etc.

----- <separation line>

Log No. Data Not Available

----- <separation line>

Log No. Date & Time & Status
Variable unit value <example: total as Accum only>
Variable unit value
etc.

If the unit is programmed for 0 logs for a particular time base then the report for that time base will only consist of the header and ID information and a “Data Not Available” message. Likewise for the 0Hr to 23Hr report to print the complete report there must be a minimum of 48 hourly logs programmed otherwise “Data Not Available” will be printed for the missing logs.

Custom Header Lines

Title of Report

Current Date & Time
Instrument Serial No. & Tag

Data Not Available

Custom Footer Lines

----- <separation line>

Printer Data Control

Some printers have limited data buffers and are therefore unable to collect all the print data being transmitted. The 500 Series has the capability of software handshaking. The Xon/Xoff characters can be used by any of the printer types to control the flow of data to ensure that data is not lost.

Some printers will also transmit an Xoff character in response to other events such as printer being off-line, print head not engaged or power being removed. The specific behaviour of the printer being used should be noted.

Error Messages

There are two printer error messages that can be displayed.

PAPER OUT

This message is related to the Printer Type PRN-03 TM295 Slip printer. It is standard procedure with this printer to check for paper status before printing. If a print is attempted but there is no paper the PAPER OUT message will be scrolled. The instrument will continue to poll the printer for paper and if paper is detected before a communications timeout expires the print will commence.

COMMS TIMEOUT

This message is relevant for all printer types and will be activated for the following conditions.

1. If the flow of data is stopped due to software or hardware handshaking and is not allowed to resume before the communications timeout.
2. If Printer Type is PRN-03 Slip printer and a paper status is requested but no response is received within the timeout period.
3. Paper Out has been detected for Printer Type PRN-03 but no paper is inserted within the timeout period.

When a communications timeout error has been activated the message COMMS TIMEOUT will be scrolled once, the request to print will be cleared and the instrument will return to its normal mode.

Appendix A

Glossary

ASCII	American Standard Code for Information Interchange. For the ASCII protocol, the instrument receives and transmits messages in ASCII, with all command strings to the instrument terminated by a carriage return. Replies from the instrument are terminated with a line-feed and a carriage-return.
IAPWS	International Association for the Properties of Water and Steam
IAPWS-IF97	IAPWS Industrial Formulation for the Thermodynamic Properties of Water and Steam. IAPWS-IF97 replaces the previous industrial standard IFC-67.
IrDA	The Infra-red Developers Association is a group of computer and software manufactures who have agreed on a format for communication among infrared devices.
K-factor	The K-factor is a constant value associated with frequency type flowmeters. It is a scaling factor used in calculations to determine volumetric flow rate.
Modbus RTU	The Modbus protocol is a message structure for communications between controllers and devices regardless of the type of network. In RTU (remote terminal unit) mode, each 8-bit byte in a message contains two 4-bit hexadecimal characters. This mode has greater character density than ASCII and allows better data throughput than ASCII for the same baud rate.
Normalised Input	A normalised input ranges from 0 to 1.000. For 4-20mA input, the signal is set to 0 at 4mA and the signal is set to 1.000 at 20mA.
NPS	Namur Proximity Switch.
Passive Output Signal	Requires an external power supply.
RTD	Resistance Temperature Device

Appendix B

Model Numbers

Product Codes

Model	Supplementary Code		Description
515	- HC01		
Enclosure	1		Panel mount enclosure
	2		Field mount enclosure (NEMA 4X / IP66)
	3/5		Explosion proof Ex d (IECEX/ATEX), metric glands (5 specifies heater)
	4/6		Explosion proof Ex d (CSA), NPT glands (6 specifies heater)
Output Options	0		4 logic inputs, 1 isolated output, 2 relays (only relay type 1 is available), RS232 (DB9) communication port
	1		4 logic inputs, 2 isolated outputs, 4 relays, real-time clock data logging, RS232 (DB9) and RS485 communication ports
	2/3		4 logic inputs, 2 isolated outputs, 4 relays, real-time clock data logging, RS232 (DB9) and Ethernet/RF communication ports (not yet available)
Relay Type	1		Electromechanical relays only
	2		2 electromechanical and 2 solid state relays
	3		Solid state relays only (not yet available)
Power Supply	U		Inputs for 12-28VDC and 100-240 VAC, 50-60Hz <i>(Previous Models: A = 110/120 VAC, E = 220/240 VAC)</i>
	D		Input for 12-28VDC power only
Display Panel Options	S		Standard option (now with backlight & LCD backup) <i>(original Full option: F, with Infra-Red comms, no longer available)</i>
PCB Protection	C		Conformal coating - required for maximum environmental operating range. Recommended to avoid damage from moisture and corrosion.
	N		None - suitable for IEC standard 654-1 Climatic Conditions up to Class B2 (Heated and/or cooled enclosed locations)
Application Pack Number	HC01		Defines the application software to be loaded into the instrument
For example: Model No. 515.111USC Displayed on the 500 Series as: Note: The first character represents the CPU installed (factory use only). The remaining 6 characters only represent hardware that affects the operation.			

Note: Example full product part number is 515.111USC-HC01 (This is the number used for placing orders).

Custom Version Codes

	Code		Description
Origin Code Identifies Distributor	00		Factory Default Application
	01		Contrec Systems Pty. Ltd. Melbourne Australia
	02		Contrec Limited. West Yorkshire UK
	03		
	04		Contrec - USA, LLC. Pelham AL 35124 USA
	05		Flowquip Ltd. Halifax UK
	06		
	etc.		
User Language	0		English (Default)
	1		German
	2		Dutch
	3		French
	4		Spanish
	5		
	etc.		
Distributor's Code	000		Distributor's own choice. Possibly a code that identifies the customer and the application.
	...		
	999		
For example: 02 3 157 Displayed on the 500 Series as:			023 157 CUSTOM VERS

Application Information Code

The Application Information code is an aid for users and service personnel to determine the type of inputs that are used in a particular application. The Application Information code is displayed on the instrument as shown below.

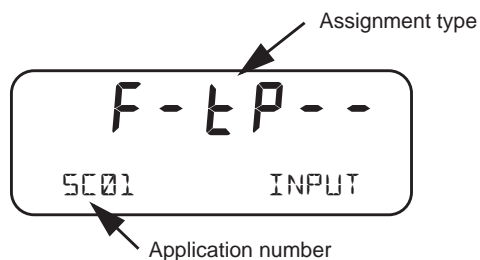

The Application number identifies the application as in the following examples:

- SC01 - steam flow computer for frequency flow meter
- GN02 - natural gas flow computer for analog flow meter

The Input Assignment type indicates the physical input that is assigned to each input on the instrument. The code is made up from six characters as follows:

FINP1	FINP2	AINP1	AINP2	AINP3	AINP4
X	X	X	X	X	X

The codes are as follows:

- - - not used in this application
- *A* - indicates a generic analog input such as level
- *d* - indicates a density input
- *F* - indicates a generic flow input such as for volume or mass, (frequency or analog)
- *H* - indicates a high flow input for stacked inputs
- *L* - indicates a low flow input for stacked inputs
- *P* - indicates a pressure input
- *q* - indicates a quadrature input
- *t* - indicates a temperature input.

For example, *F - t P - -* is an instrument with FINP1 (frequency input 1) assigned to a flow input, AINP1 assigned to a temperature input and AINP2 assigned as a pressure input. The other inputs are not used.

Appendix C

Units of Measurement

Available Units of Measurement

The following is a list of the available units of measurement used across the range of 500 Series applications.

Units Type	Available units of measurement
Volume	m ³ , Km ³ , Ltr, mL, Gal, KGal, MGal, ft ³ , kft ³ , Mft ³ , bbl
Volume Flowrate	m ³ /s, m ³ /min, m ³ /h, m ³ /D, L/s, L/min, L/h, L/day, mL/s, mL/min, mL/hr, Gal/s, Gal/min, Gal/h, KGal/D, MGal/D, ft ³ /s, ft ³ /min, ft ³ /h, Mft ³ /D, bbl/s, bbl/min, bbl/h, bbl/D
Volume K-Factor	P/m ³ , P/Ltr, P/mL, P/Gal, P/ft ³ , P/bbl
Mass	kg, g, Ton, lb, Klb
Mass Flowrate	kg/s, kg/min, kg/h, g/s, g/min, g/h, Ton/min, Ton/h, Ton/D, lb/s, lb/min, lb/h, Klb/min, Klb/h, Klb/D
Mass K-Factor	P/kg, P/g, P/Ton, P/lb, P/Klb
Energy	kJ, MJ, GJ, kWh, MWh, kBTU, Ton.h, therm, cal, kcal, Mcal
Power	kJ/h, MJ/h, GJ/h, kW, MW, kBT/M, kBT/h, Ton, therm/min, therm/h, kcal/h, Mcal/h
Energy K-Factor	P/kJ, P/kWh, P/kBTU, P/Ton.h, P/therm, P/kcal
Temperature	Deg K, Deg C, Deg F, Deg R
Pressure	Pa, kg/m ² , kg/cm ² , kPa, MPa, mbar, bar, psi, Atm, inH ₂ O, mmH ₂ O
Density	kg/m ³ , kg/Ltr, lb/ft ³ , SG60F
Specific Volume	m ³ /kg, L/kg, ft ³ /lb
Specific Enthalpy	kJ/kg, BT/lb, cal/g, cal/kg, kcal/kg, Mcal/kg
Reynolds Number	E+0, E+3, E+6 (scaling for unitless variable)
Length (Level)	m, mm, cm, INCH, FOOT
Velocity	m/s, m/M, m/h, ft/s, ft/M, ft/h
Length K-Factor	P/m, P/cm, P/INCH, P/FOOT
Area	m ² , ft ²
Ratio	%
General Input	Pressure, Temperature, Density, Length (Level), Factor

Index

Numerics

- 0-5V input 14
- 4-20mA
 - input 15
 - output 17

A

- ACCUM key 24
- address, instrument 56
- alarm
 - connection 18
 - equipment failure 42
 - hysteresis 43
 - relays 42
 - setpoint 43
- alarms menu 42
- analog input
 - connections 14
 - failure 51
 - scaling 3
- application code 74
- approvals 6
 - FCC Declaration 6
- ASCII protocol 55

B

- back panel 12
- battery
 - failed 52
 - life 45
 - new 52
- baud rate 44

C

- calibration
 - menu 32
 - set mode 30
 - view mode 29
- clock
 - battery 45
 - date format 46
 - real-time 45

codes

- application information 74
 - customer version 74
 - exception 64
 - product number 73
- ## communication
- connections 20
 - protocols 55
- ## communications 4, 53
- menu 44
- ## connections
- alarm 18
 - communication 53
 - communications 20
 - electrical 12
 - input 13
 - output 17
- ## customer version codes 74
- ## customizing a printout 66

D

- daily logging 46
- data log
 - viewing 25, 26
- data logging
 - daily 46
 - hourly 46
 - monthly 47
 - weekly 47
 - yearly 47
- date format 46
- declaration FCC 6
- default on exception 51
- default total 23
- display
 - specifications 9
 - timeout mode 48
 - timeout time 48
- DISPLAY key 24
- display-only parameter 29

E

earthing 21
electrical connections 12
equipment failure alarm 42
error condition, override 51
error messages 51
exception codes 64
Exception Status 57
exception, default 51

F

failure of input 51
features 1
flash driver port assignment 45
fluid types 5
format, date 46
frequency input connection 13
front panel
 keys 24
 LEDs 23

G

glossary 71

H

hardware connections 53
hourly logging 46
hysteresis, alarm 43

I

infra-red port 44
input
 0-5V 14
 4-20mA 15
 connections 13
 analog 14
 frequency 13
 failure 51
 RTD 15
 sensor failure 51
 types 5
inputs menu 36
installation 11
instrument
 address 56
 request format 55
 responses 57
 settings 34
interconnections, communication 53

interference suppression 19
isolated outputs 4

K

key
 ACCUM 24
 DISPLAY 24
 RATE 24
 RESET 24
 TOTAL 24
keys, front panel 24

L

LEDs, status 23
limits
 temperature 5
logged data 25
 viewing 26
logging
 daily 46
 hourly 46
 monthly 47
 weekly 47
 yearly 47
logic input connection 16

M

main menu items 24
menu
 alarms 42
 calibration 32
 comms 44
 inputs 36
 outputs 40
 params 35
 setup 48
 test 49
 tm/log 45
 units 34
messages
 error 51
 system 50
 warning 52
Modbus data format 45
Modbus RTU protocol 61

mode
 display timeout 48
 normal operation 23
 operation 2
 set calibration 30
 view calibration 29

model numbers 73

monthly logging 47

mounting 11

N

normal operation 23

number
 model 73
 serial 28

O

operation mode 2

operation, normal 23

output
 connections 17
 4-20mA 17
 pulse 18
 pulse factor 41

outputs menu 40

override error condition 51

P

panel
 LEDs 23
 mounting 11
 rear 12

parameter
 display-only 29
 not visible 29
 password-protected 29
 programmable 29

parameters menu 35

parity bits 44

password-protected parameter 29

peak flowrates 25

port
 assignment, flash driver 45
 flash driver assignment 45
 infra-red 44
 RS-232 20, 44, 53
 RS-485 20, 44, 54

power supply interruption 45

printer
 data control 70
 error messages 70
 protocol 66
 report types 66

printer types 66

printouts
 individual logs 68
 live data 67
 log report 68
 types 67

product number codes 73

programmable parameters 29

protocol
 ASCII 55
 communication 55
 Modbus RTU 61
 printer 66

pulse factor, output 41

pulse output 18

R

RATE key 24

real-time clock 45

rear panel 12

relay outputs 4

relays, alarm 42

RESET key 24

responses, instrument 57

RS-232 port 20, 44, 53

RS-485 port 20, 44, 54

RTD input 15

RTU protocol 61

S

scaling analog input 3

serial number 28

setpoint, alarm 43

settings
 instrument 34

setup menu 48

shielding 21

snubber 19

specifications 9

standards 6

status LEDs 23

stop bits 44

suppression, interference 19

system

- errors 51
- messages 50
- warnings 52

T

- terminal designations 12
- test menu 49
- timeout
 - mode 48
 - time 48
- tm/log menu 45
- TOTAL key 24
- total, default 23

U

- unit tag 28
- units
 - menu 34

V

- version, customer 74
- view data logs 25, 26

W

- warnings 52
- weekly logging 47

Y

- yearly logging 47