

**FIELD MOUNTED  
RATE TOTALISER  
MODEL 202A**





# CONTENTS

<b>1. Introduction</b>	<b>3</b>
1.1 Model Number Versions	4
1.2 Intrinsic Safety Approvals	6
1.3 Operation	7
<b>2. Specification</b>	<b>8</b>
<b>3. Programming</b>	<b>10</b>
3.1 Program Steps	11
3.2 Calculation of Rate and Total	14
3.3 Total Conversion	16
3.4 Filtering	17
3.5 Example	19
<b>4. Signal Input</b>	<b>20</b>
<b>5. Alarm &amp; Pulse Outputs</b>	<b>21</b>
<b>6. Intrinsic Safety Connections</b>	<b>23</b>
<b>7. Installation</b>	<b>25</b>
7.1 Wall Mounting	25
7.2 Panel Mount Version	26
7.3 Removing the Front Panel	27
7.4 The Main Electronics	29
7.5 Wiring	30
7.6 Maintenance	30
7.7 Terminal Designations	31
<b>Index</b>	<b>32</b>



# 1. INTRODUCTION

The Model 202Ai Rate-Totaliser is a microprocessor based instrument designed to measure a 4-20mA signal from flowmeters and pressure transducers. The instrument can be programmed to display directly in engineering units and includes features such as linear or square law calculation, integration and digital filtering.

Rate, Total and Accumulated Total can be displayed in engineering units on the large LCD display. A front panel switch selects the function for display and a Reset button allows the Total to be reset to zero.

The instrument is fully programmable, with all calculation constants set via the front panel switches and stored in a non-volatile memory which will retain data indefinitely. The user can program span, filtering levels, display resolution and cutoff point.

The instrument is powered from a 4-20mA input signal and therefore, requires no external power.

The Model 202Ai Rate Totaliser conforms to the EMC-Directive of the Council of European Communities 2004/108/EC, the LVD directive 2006/95/EC and the following standards:

<i>EN61326:2013</i>	Electrical equipment for measurement, control and laboratory use – EMC requirements : Residential, Commercial & Light Industry Environment & Industrial Environment.
<i>EN61010:2010</i>	Safety requirements for electrical equipment for measurement, control, and laboratory use.

In order to comply with these standards, the wiring instructions in Section 7.5 must be followed.

## 4 Introduction

### 1.1 MODEL NUMBER VERSIONS

The Model Number describes the options available for the 202Ai as follows:

#### **Model 202Ai . x**

where x denotes the mounting options and will be replaced by one of the following numbers:

- 0** No holes drilled for cable entry
- 1** Panel mount
- 2** Wall mount (standard)
- 6** for Pipe mounting

The Wall mount instrument is supplied with cable glands that are watertight and have integral strain relief.

#### **Approval Versions**

- C** CSA USA / Canada Approval
- M** ATEX/IECEX Approval

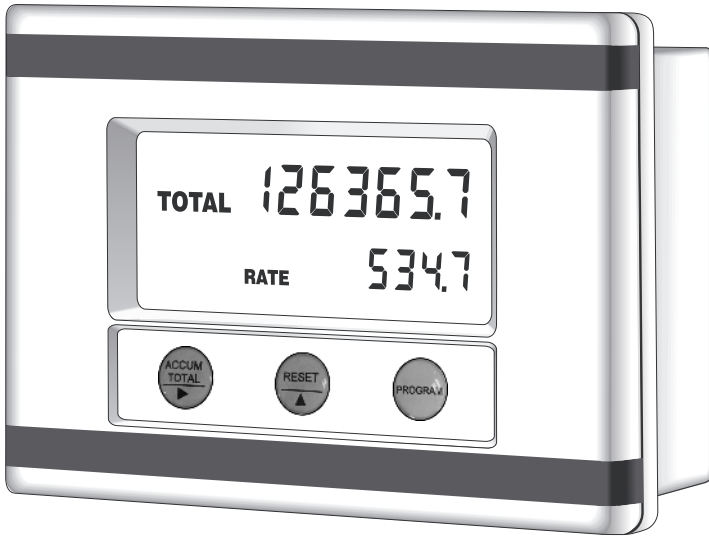

**The Model 202A**

## 6 Introduction

### 1.2 INTRINSIC SAFETY APPROVALS

The Model 202Ai is certified for use in hazardous areas and has IECEx, ATEX and CSA *us/c* approvals.

The Model 202Ai certification details are:

IECEx Approval Rating	IECEx BVS 15.0099X Ex ia IIB T4 Gb
--------------------------	---------------------------------------

ATEX Approval Rating	BVS 15 ATEX E 106 X II 2G Ex ia IIB T4 Gb
-------------------------	--

Ambient Temperature:	Maximum ambient temperature of 60°C.
----------------------	--------------------------------------

CSA <i>us/c</i> Approval Type:	LR 104 840-5. Class 1, Groups C and D.
-----------------------------------	---

When installing in hazardous areas, the instrument must be installed according to the guidelines in Section 2 and in accordance with the local relevant standards for wiring and installation in hazardous areas.

#### **4-20mA Input**

The input can be connected to IS circuits with the following maximum values:

$U_i$	=	28V
$I_i$	=	93mA
$P_i$	=	653mW

#### **Relay Outputs**

The outputs can be connected to IS circuits with the following maximum values:

$U_i$	=	28V
$I_i$	=	93mA
$P_i$	=	653mW



## 7 Specification

### 1.3 OPERATION

The Model 202A Rate Totaliser will display:

*Rate*  
*Resettable Total*  
*Accumulated Total*

Both the Rate and Resettable Total are continuously displayed while the Accumulated Total is only displayed when the ACCUM TOTAL key is pressed.

The Resettable Total can be reset at any time by pressing the RESET key.

The instrument also has a test mode which can be entered by simultaneously pressing all three front panel keys. The tests are as follows:

*Lo Test*                      By pressing the ACCUM TOTAL key, the low alarm output will go low.

*Hi Test*                      By pressing the RESET key, the high alarm output:  
a. will go low if CAL00 = 0 (high alarm output),  
b. will output 100ms pulses every 0.5sec if CAL00 = 1 (scaled pulse output).

*Display Test*                By pressing the PROGRAM key, all segments of the display will show.

To exit the test mode, simultaneously press all three front panel keys.

Note that when the input signal drops below 3.75mA (4-20mA input), a signal error will occur. The display will alternate between the current total and the word "SIGNAL". When the input signal drops below  $\approx 3.5$ mA the Model 202A shuts down saving totals in the non-volatile memory.

## 2. SPECIFICATION

### *General*

Display:	LCD, which is continuously powered.
Resettable Total:	7 digits with 10mm (0.4") high digits. Resettable from front panel.
Accumulated Total:	Displayed when the Accumulated Total button is pressed.
Rate/Display:	5 digits with 8.5mm (0.33") high digits.
Span:	The units of measure per timebase (eg. gallons/sec) is programmable in the range 0.000001 to 999,999.
Decimal Points:	Decimal Point positions are fully programmable for both rate and total.
Timebase:	Span can be programmed in units per second, minute, hour or day.
Signal Type:	4-20mA.

### *4-20mA Input*

Resolution and Linearity:	0.05% of span.
Accuracy:	0.05% of span @ 25°C. 0.1% (typ) of span, full temperature range.
Update Time:	0.5 seconds.
Connection:	Two wire.
Voltage Drop:	2.5 volts maximum.

**Outputs**

Type:	Two open collector outputs suitable for driving DC solenoids or external relays. The outputs provide high and low flow alarms or pulse output and low flow alarm.
Switching Power:	200mA. 30VDC maximum.
Saturation Voltage:	0.8VDC typical across the output in the "on" state.
Isolation:	Both outputs are separately opto-isolated.
Pulse Duration: (for pulse output)	If CAL00 = 1 (scaled pulse output): <ol style="list-style-type: none"> <li>1ms if output frequency &gt; 50Hz,</li> <li>10ms if output frequency is 5 ... 50Hz,</li> <li>100ms if output frequency is &lt; 5Hz.</li> </ol>

**Physical**

Temperature:	Operating Temperature: -20°C to 60°C.
Dimensions:	97mm (3.8") high x 150mm (5.9") wide x 41mm (1.6") deep (cable glands not included).
Protection:	Sealed to Nema 4x or IP67 standards.
Cable Entry:	By cable glands.
Wall Mounting:	Universal Mounting Bracket supplied as standard.
Pipe Mounting:	A galvanised metal bracket is available which enables the Model 202A to be attached to a 2" vertical or horizontal pipe.
Panel Mounting:	Supplied with mounting brackets. Terminals accessible from rear. (Note that the panel mount version is not watertight.) Cutout: 141mm (5.6") wide x 87mm (3.4") high.

# 3. PROGRAMMING

The Model 202A is fully programmable, with all parameters being stored in non-volatile memory.

The Program Mode can be entered in the following way:

By removing the lower cover strip (i.e. the dark grey strip along the bottom of the enclosure) and replacing it the wrong side up. This brings a small magnet on the inside of the cover strip in contact with a reed switch inside the instrument.

The PROGRAM switch is used to step through the program (CAL sequences) and The  $\blacktriangleright$  and  $\blacktriangle$  keys on the front panel are used to change and increment the flashing digits.

The CAL number is displayed on the lower display and the parameter is displayed on the upper display.

Parameters in Program Mode that consist of the two parts, **whole numbers** and **digits after the decimal point**, are restricted to having a maximum of 6 significant digits. Therefore the number of significant digits entered in the *whole numbers* determines the number of digits that are able to be entered in the *digits after the decimal point*.

## For Example

000001 in the whole numbers makes 00000 available after the decimal place.

000100 in the whole numbers makes 000 available after the decimal place.

010000 in the whole numbers makes 0 available after the decimal place.

### 3.1 PROGRAM STEPS

<i>Step</i>	<i>Comment</i>
CAL 00	<p><b>Pulse Output.</b></p> <p>0 = No pulse output, low and high alarms 1 = Scaled pulse output and low alarm</p>
CAL 01	<p><b>Span - whole numbers.</b></p>
CAL 02	<p><b>Span - digits after the decimal point.</b></p> <p>The Span is the number of units of measure per timebase (e.g. litres/sec, Gal/min). The Span can be programmed in the range of 0.000001 - 999,999.</p> <p>See section 3.2.</p>
CAL 03	<p><b>Cutoff Point.</b></p> <p>This determines the cutoff point as a fraction of Span. See section 3.2.2.</p>
CAL 04	<p><b>Decimal Point for Rate Display.</b></p> <p>The flowrate can be displayed with 0, 1, 2 or 3 decimal point places.</p>
CAL 05	<p><b>Timebase for Rate.</b></p> <p>The Rate can be displayed in units per second, minute, hour or day.</p> <p style="padding-left: 40px;">0 = second 1 = minute 2 = hour 3 = day.</p> <p>See section 3.2.</p>

## 12 Programming

*Step*            *Comment*

CAL 06            **Filter.**

Fluctuations in the flowrate can be filtered out so that the Rate is held steady. The filter value is programmed between 1 - 99 where "1" represents ***no filtering*** and 99 is maximum.

See section 3.4.

CAL 07            **Decimal Point for Total Display.**

The totals can be displayed with 0, 1, 2 or 3 decimal points.

CAL 08            **Total Conversion Factor - whole numbers.**

CAL 09            **Total Conversion Factor - digits after the decimal point.**

The Total Conversion Factor enables the Rate to be displayed in one engineering unit and the Totals to be displayed in another engineering unit. The Total Conversion Factor can be programmed in the range of 0.000001 - 999,999. Set to 1.000 if totals and rate are in the same unit eg. litres.

See section 3.3.

CAL 10            **Low Alarm - whole numbers.**

<i>Step</i>	<i>Comment</i>
CAL 11	<p><b>Low Alarm - digits after the decimal point.</b></p> <p>CAL 10 &amp; 11 program the flowrate below which the low alarm relay will close. The value can be programmed in the range 0 to 999,999.</p>
CAL 12	<p><b>High Alarm or Pulse Output Factor - whole numbers.</b></p>
CAL 13	<p><b>High Alarm or Pulse Output Factor - digits after the decimal point.</b></p> <p>CAL 12 &amp; 13 program the flowrate above which the high alarm relay will close. The value can be programmed in the range 0 to 999,999.</p> <p>If the pulse output is selected (see CAL 00), the value will represent the total per pulse. eg. 5 litres per pulse.</p>
CAL 14	<p><b>Input Flow Relationship.</b></p> <p>0 = Linear Input 1 = Square Root Input</p>
CAL 15	<p><b>Accumulated Total Reset.</b></p> <p>CAL 15 displays the accumulated total which can be reset by pressing and holding the RESET key for about 5 seconds.</p>
SOFT	<p><b>Software Version.</b></p>

## 14 Programming

### 3.2 CALCULATION OF RATE AND TOTAL

#### 3.2.1 Analog Input

The flowrate, R, is calculated as follows:

$$R = SA \quad \text{if the linear relationship is selected}$$

or 
$$R = S \sqrt{A} \quad \text{if a square law relationship is selected}$$

where A = the input value

S = the span

At the minimum input (i.e. 4mA), A = 0, and at the maximum input (i.e. 20mA), A = 1.

The Span, S, can be set during calibration anywhere in the range of 0.000001 to 999,999.

The Span, S, is programmed in units of volume per timebase (ie. litres/minute or kilograms/hour). This also means that the Total will be displayed with the same unit of volume, ie. litres or kilograms.



### 3.2.2 The Cutoff Point

Because many transducers do not always exactly transmit 4mA when they are at zero rate, it is often necessary to define a rate below which no integration takes place. This is termed the cutoff point and is programmed as a percent age of the Span, S.

For example, if  $S = 2200$  kg/min in a square law system, and the cutoff point is set at 20.0%, the actual cutoff rate  $R_c$  can be determined as follows:

The cutoff rate is defined as:

$$R_c = 2200 \sqrt{A}$$

At 20% cutoff,

$$\begin{aligned} R_c &= 2200 \times 0.2 \\ &= 440 \text{ kg/min} \end{aligned}$$

The value of A which would produce this cutoff is:

$$A = 0.04 \quad (\text{since } \sqrt{0.04} = 0.2)$$

and the input signal would be:

$$\begin{aligned} I &= 16\text{mA} \times 0.04 + 4\text{mA} \\ &= 4.64\text{mA} \end{aligned}$$

## 16 Programming

### 3.3 TOTAL CONVERSION

The Total Conversion feature enables the rate to be displayed in one engineering unit (e.g. gallons/minute) and the totals to be displayed in another engineering unit (e.g. barrels).

The Span is always programmed in the unit relating to *Rate*, and the Total Conversion constant is a division factor which can be used to convert the totals to the different unit. The Total Conversion factor affects the resettable and accumulated totals.

#### For Example.

If the Rate is required in gallons per minute:

1. The Span would be programmed as gallons per minute.
2. The timebase would be programmed as minutes.

If the Totals are required in barrels:

3. The Total Conversion factor is programmed as 42 (there are 42 gallons in a barrel). All totals will now totalise in barrels.

Some common units are given below together with the Total Conversion constant which should be programmed.

Rate*	Totals	TOTCON
Gallons (US)/	Barrels (oil)	<u>42.000</u>
Litres/	Kilolitres	1000
ml/	Litres	1000
Mgallons/	Acre-feet	0.32587

- \* Units per second, minute, hour or day. The timebase is programmed separately during Programming.

### 3.4 FILTERING

Frequency fluctuations caused by pulsating flow through a flowmeter, often makes the Rate impossible to read with any precision.

The Model 202A has a digital filter which will average out these fluctuations and enable the Rate to be read to four digit accuracy. The ability to select a suitable filtering level means that highly accurate and stable readings can be obtained without excessive lag.

The diagram below shows a pulsating signal input together with the effect of filtering.

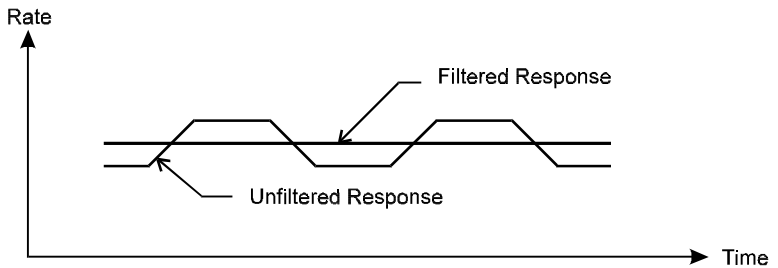

As a guideline to the degree of filtering to be used, the following table shows the response to a step change in input. The value, CAL 06, is the filter constant which is programmed during the Programming routine. The times for the display value to reach 90% and 99% of full swing are given in seconds, for different values of CAL 06.

## 18 Programming

<b>A</b>	<b>90%</b>	<b>99%</b>
1	0	0
2	1	2
4	2	4
6	3	6
10	5	11
15	8	17
20	11	22
25	14	28
35	20	40
45	25	51
60	34	69
75	43	86
90	52	103
99	57	113

Table 1 - Response to a step Input (in seconds).

Note that if CAL 06 is set to 01 there is no filtering of the input signal.

### 3.5 EXAMPLE

A vortex flowmeter has a maximum output of 20.538 litres/min at 20mA. It is required to display the flowrate in litres/min with 1 decimal point and the total in litres with no decimals. High and low alarms are required at 18 l/m and 2 l/m respectively. The instrument is then programmed as follows:

CAL00	0	No Pulse Output
CAL01	00020	Span (Whole Numbers)
CAL02	5380	Span (Decimals)
CAL03	0.05	Cutoff Point as a fraction of Span
CAL04	1	Rate decimal position
CAL05	1	Timebase
CAL06	01	Filter disabled
CAL07	0	Total decimal position
CAL08	0001	Total Conversion (set to 1.0000)
CAL09	0000	Total Conversion (decimals)
CAL10	00002	Low Alarm
CAL11	0000	Low Alarm
CAL12	00018	High Alarm
CAL13	0000	High Alarm
CAL14	0	Linear Input
CAL15		xxxx Accumulated Totals
SOFT	202A1.11	Software Version

## 4. SIGNAL INPUT

The signal input is on terminals 3 and 4 and can be connected as follows:

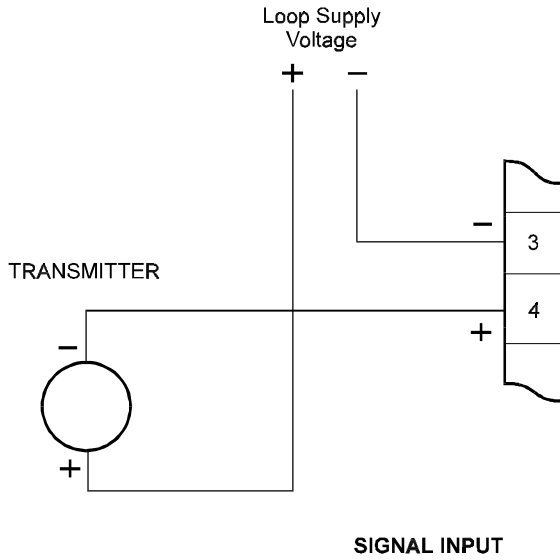

## 5. ALARM & PULSE OUTPUTS

Open collector outputs are provided for high and low flowrate alarms. The output can sink up to 200mA and can be used to power external relays, lights or audible alarms. The outputs are internally protected against voltage spikes caused by relays and coils.

Both outputs are separately isolated via opto isolators.

As an alternative to a high flowrate alarm, the output on terminals 7 and 8 can be programmed to output a scaled pulse output.

The switching points can be programmed during the setup mode and the low flow alarm will switch on whenever the flowrate drops below the programmed flowrate. Similarly, the high alarm switches on whenever the flow exceeds the high setpoint.

If a Scaled Pulse Output is programmed, a pulse will be output every preset value of the total. For example, if the total is in litres, then programming 5 will output one pulse every 5 litres. The duration of pulses is adjusted automatically to the output frequency.

### ***Specification for Alarm Outputs***

Maximum Current (sink):	200mA.
Maximum Voltage:	30VDC.
Saturation Voltage:	0.8VDC across Outputs when in the "on" state.
Isolation:	Both outputs are separately isolated.
Pulse Frequency:	500Hz maximum.
Pulse Duration:	1ms if output frequency > 50Hz. 10ms if output frequency = 5 ... 50Hz. 100ms if output frequency < 5Hz.

## 22 Alarm & Pulse Outputs

### Connections

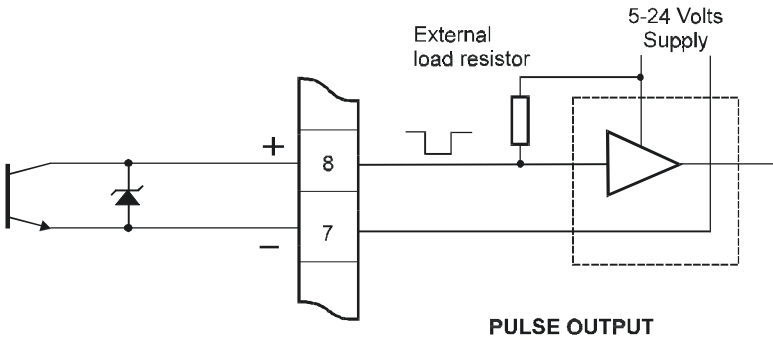
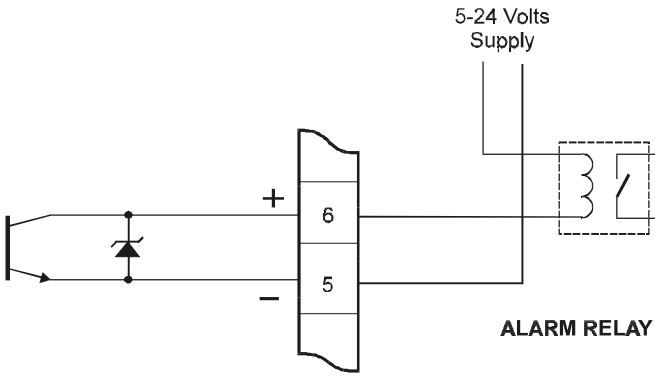



## 6. INTRINSIC SAFETY CONNECTIONS

When installing the Model 202Ai in hazardous areas, the wiring and installation must comply with appropriate installation standards.

The approval uses entity parameters and an associated apparatus type approval on the input/output connections to the 4-20mA current loop and alarms. The 4-20mA input and alarm outputs must, therefore, only be connected as shown on the following page, to barriers with the specified parameters.

The Model 202A will connect directly to a 4-20mA current loop and alarms, provided they do not exceed the following input parameters:

$$\begin{aligned}U_i &= 28\text{V} \\I_i &= 93\text{mA} \\P_i &= 653\text{mW}\end{aligned}$$

The internal capacitance seen on the input (terminals 3 & 4) is 0.02uF while the internal capacitance seen on the output (terminals 5-8) is 0.1uF maximum.

Inductance is negligibly small on both the input and output.

### **Outputs**

The two open collector outputs must only be connected to certified IS equipment via barriers as shown on the following page. Only certified intrinsically safe solenoids may be used for IS applications.

**SAFE AREA**

**HAZARDOUS AREA**

**SAFE AREA**

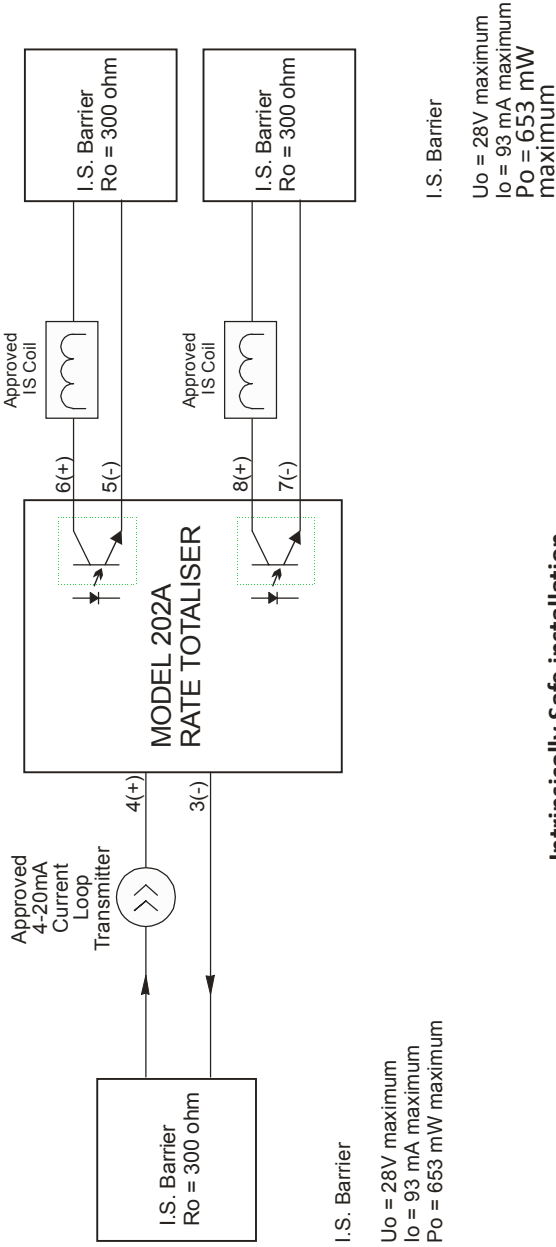

**Intrinsically Safe installation**

# 7. INSTALLATION

## 7.1 WALL MOUNTING

A wall mounting bracket is supplied with each instrument. The bracket should be attached to the wall using round head screws (do not use counter sunk screws).

The bracket is mounted with the "tray" section at the bottom. The instrument is then attached to the bracket at the bottom with two screws (see diagram below).

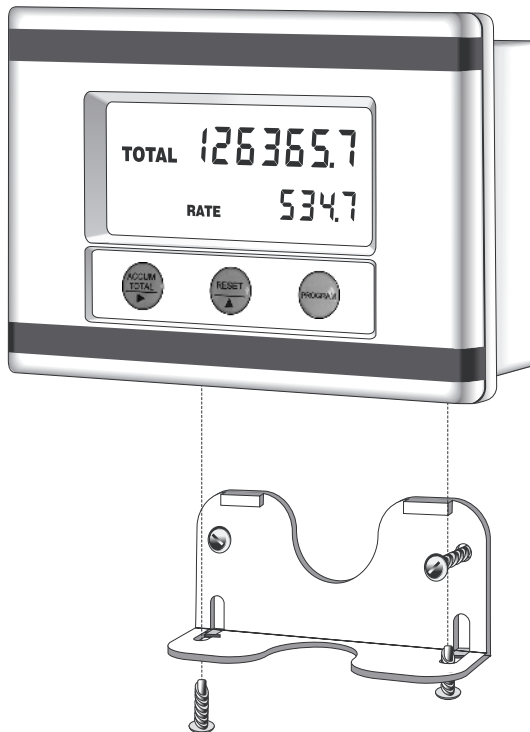

## 26 Installation

### 7.2 PANEL MOUNT VERSION

The panel mount version of the Model 202Ai is supplied with two panel mount brackets and plug-in terminals which are accessible from the rear of the instrument.

A diagram of the rear panel is shown below.

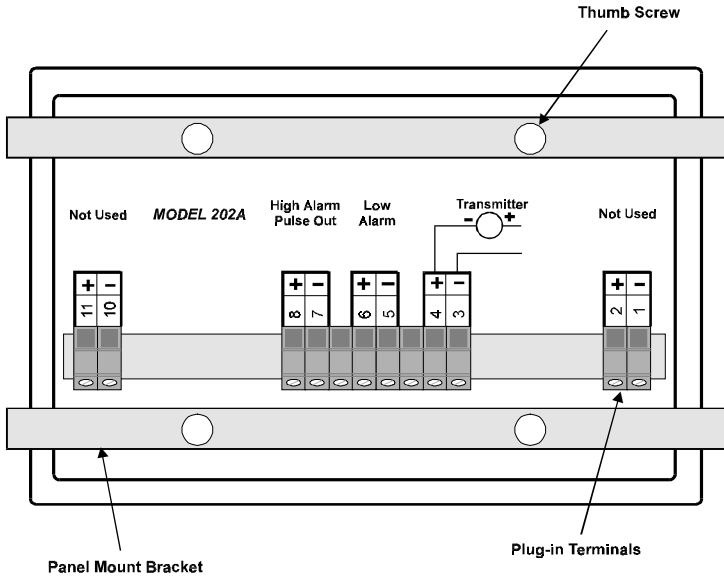

**REAR VIEW OF  
202A PANEL MOUNT CASE**

The cutout for the panel mount version is 141mm (5.55") wide x 87mm (3.43") high.

### 7.3 REMOVING THE FRONT PANEL

The front of the instrument is removed as follows:

1. Remove both the top and bottom cover strips (i.e. the dark plastic strips on the front) by levering a screwdriver under one end.
2. Undo the seven screws retaining the front. *Note that the screws should not be removed from the front panel as they are retained by O-rings.*
3. Pull the front panel free from the housing.

Replacing the front panel of the instrument is the reverse procedure. However, ensure that the front panel is aligned at both connector points before tightening the screws.

28 Installation

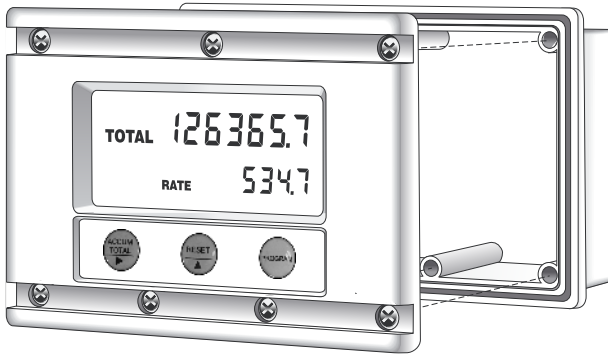
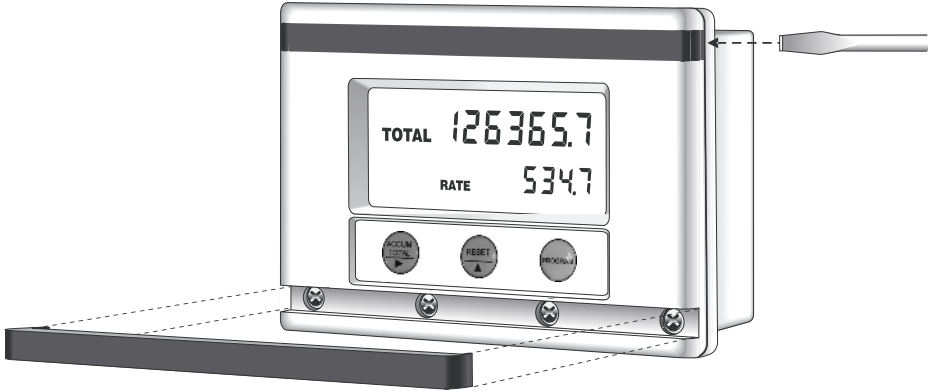

## 7.4 THE MAIN ELECTRONICS

The front section of the housing contains the microprocessor and display.

It is also possible to adjust the display contrast via a small potentiometer on the board. The DISPLAY CONTRAST control is shown below and this can be adjusted for optimum contrast.

Adjacent to this control is a RESET switch which can be used to reset the microprocessor. Note that pressing this button will Set all totals to zero and calibration parameters to default values.

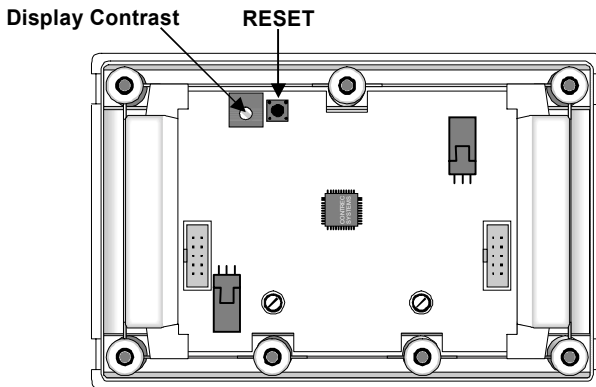

**The Main Electronics**

## **30 Installation**

### **7.5 WIRING**

When connecting the Model 202A, it is good practice to use shielded cable.

This wiring practice is mandatory in order to comply with the requirements for Electromagnetic Compatibility as per EMC-Directive 2004/108/EC of the Council of the European Community.

### **7.6 MAINTENANCE**

All printed circuit boards must be repaired by Contrec. In the case of a fault, no attempt should be made to repair the board as the intrinsically safe certification may be impaired.

#### **SPECIAL CONDITIONS FOR SAFE USE**

**To comply with this product's ATEX/IECEx certification the special conditions for safe use must be followed.**

**The Instrument type 202Ai shall be mounted in an area where electrostatic charge/discharge will be avoided.**



## 7.7 TERMINAL DESIGNATIONS

### **4-20mA Input**

3	4-20mA (-)
4	4-20mA (+)

### **Outputs**

5	Low Alarm (-)
6	Low Alarm (+)
7	High Alarm (-) or Pulse Output (-)
8	High Alarm (+) or Pulse Output (+)

# Index

## A

Accumulated Total, 6

## C

CAL Sequences, 10

Cutoff Point, 11

## D

Decimal Point, 11

Display, 8

Display Test, 6

## F

Filtering, 17

## H

Hi Test, 6

High Alarm, 13

## I

Installation, 25

Intrinsic Safety, 7

## L

Lo Test, 6

Low Alarm, 12

## M

Model Number, 4

## O

Operating

Temperature, 9

Operation, 6

## P

Panel Mount, 26

Programming, 10

Protection, 9

Pulsating Signal, 17

Pulse Output, 21

## R

Rate, 6

Removing the Front  
Panel, 27

Resettable Total, 6

Response, 18

## S

Span, 11

Specification, 8

## T

Temperature, 9

Terminal

Designations, 31

Test Mode, 6

Timebase, 11

Total Conversion, 16

## W

Wall Mounting, 25